

# Telematics SDK

## API Reference v1.63.6

80-PF458-2 Rev. AP  
May 7, 2024

All Qualcomm products mentioned herein are products of Qualcomm Technologies, Inc. and/or its subsidiaries.

Qualcomm is a trademark of Qualcomm Incorporated, registered in the United States and other countries. Other product and brand names may be trademarks or registered trademarks of their respective owners.

This technical data may be subject to U.S. and international export, re-export, or transfer ("export") laws. Diversion contrary to U.S. and international law is strictly prohibited.

Qualcomm Technologies, Inc.  
5775 Morehouse Drive  
San Diego, CA 92121  
U.S.A.

# Revision History

Revision	Date	Description
<b>AP</b>	Oct 2023	Updated documentation for SDK release V1.63.0 changes
<b>AN</b>	Sep 2023	Updated documentation for SDK release V1.62.0 changes
<b>AM</b>	Aug 2023	Updated documentation for SDK release V1.61.0 changes
<b>AL</b>	Jul 2023	Updated documentation for SDK release V1.60.0 changes
<b>AK</b>	Jun 2023	Updated documentation for SDK release V1.59.0 changes
<b>AJ</b>	May 2023	Updated documentation for SDK release V1.58.0 changes
<b>AH</b>	Apr 2023	Updated documentation for SDK release V1.57.0 changes
<b>AG</b>	Mar 2023	Added documentation for thermal notifications
<b>AF</b>	Dec 2022	Added documentation for crypto accelerator
	Nov 2022	Added support for Third Party Service (TPS) eCall over IMS
<b>AE</b>	Nov 2022	Updated documentation for SDK release V1.54.0 changes
<b>AD</b>	Sep 2022	Updated documentation for SDK release V1.53.0 changes
<b>AC</b>	Jul 2022	Updated documentation
<b>AB</b>	Apr 2022	Added documentation for API access control
<b>AA</b>	Mar 2022	Addition of documentation for Call flow of control filesystem for ECALL operation
	Apr 2022	Added crypto APIs call flows
	Jan 2022	Updated C-V2X radio call flows
	Dec 2021	Addition of documentation for sensor self test APIs
	Dec 2021	Addition of documentation for ECALL and OTA operation APIs
	Nov 2021	Support for Xtra feature in location
	Sep 2021	Addition of new sub system Readiness APIs for Modem Config
	Aug 2021	Addition of Subsystem Restart handling in Telsdk
	Aug 2021	Added further EFS API related information for platform sub-system
	Jul 2021	Updated thermal subsystem readiness flow for new methodology
	Jun 2021	Addition of Remote SIM provisioning APIs and related call flows
	Jun 2021	Addition of documentation for platform subsystem
	Apr 2021	Addition of documentation for sensor subsystem
	Apr 2021	Addition of Serving System Manager APIs for data
	Mar 2021	Addition of calibration init status API for audio
	Feb 2021	Addition of new sub system Readiness APIs for Audio
	Jan 2021	Updated Data Subsystem Readiness flow for new methodology
	Feb 2021	Addition of configure NMEA types in location SDK
	Jan 2021	Addition of Audio Subsystem Restart Support
	Jan 2021	Addition of terrestrial positioning APIs and callflows in location SDK
	Nov 2020	Addition of Year of hardware and configure engine state APIs in location and callflows
	Nov 2020	Addition of cv2x SE-linux interface documentation
	Aug 2020	Addition of Location Manager APIs, Location Configurator APIs and callflows
	May 2020	Addition of Public Logging API
	May 2020	Addition of L2TP to Data Networking APIs and call flows
	Apr 2020	Addition of Security section with SE-linux interface documentation
	Mar 2020	Addition of Robust Location API in Location Configurator and call flows
	Feb 2020	Addition of Location Configurator APIs and call flows
Jan 2020	Addition of Socks Proxy to Data Networking APIs and call flows	

**Table 1 Revision history (cont.)**

<b>Revision</b>	<b>Date</b>	<b>Description</b>
	Jan 2020	Addition of Data software bridge management APIs and call flows
	Nov 2019	Addition of Compressed audio format playback on voice paths APIs and call flows
	Nov 2019	Addition of Data Networking APIs and call flows
	Nov 2019	Addition of Audio Format Transcoding APIs and call flows
	Oct 2019	Addition of Location constraint time uncertainty APIs and call flows
	Oct 2019	Addition of Location concurrent report APIs and call flows
	Oct 2019	Addition of Data Filter APIs and call flows
	Sep 2019	Addition of modem config APIs and related call flows
	Sep 2019	Addition of Audio APIs for compressed audio format playback and related call flows
	Sep 2019	Addition of Audio APIs for Loopback, Tone Generator and related call flows
	Sep 2019	Addition of Remote SIM APIs and call flows
	Jul 2019	Addition of Thermal shutdown manager APIs and call flows
	Jul 2019	Updated the Location APIs and call flows
	Jun 2019	Addition of Audio APIs for play, capture, DTMF and related call flows
	May 2019	Addition of TCU Activity Management APIs and call flows
	Mar 2019	Addition of Thermal manager APIs and call flows
	Jan 2019	Addition of Audio APIs and call flows
	Nov 2018	Addition of C-V2X APIs
	Oct 2018	Addition of Network Selection and Serving System Management APIs and call flows
	Jun 2018	Added Cellular Connection Management APIs
	Dec 2017	Added subscription APIs and section on Versioning and API Status
	Sep 2017	Initial release

# Contents

---

<b>1</b>	<b>Introduction</b>	<b>6</b>
1.1	Purpose	6
1.2	Scope	6
1.3	Conventions	6
1.4	SDK Versioning	6
1.5	Public API Status	7
<b>2</b>	<b>Functional Overview</b>	<b>8</b>
2.1	Overview	8
2.2	Features	10
2.2.1	Call Management	10
2.2.2	SMS	11
2.2.3	SIM Card Services	11
2.2.4	Phone Information	11
2.2.5	Location Services	12
2.2.6	Data Services	12
2.2.7	Network Selection and Serving System Management	14
2.2.8	C-V2X	14
2.2.9	Audio	15
2.2.10	Thermal Management	17
2.2.11	Thermal Shutdown Management	18
2.2.12	TCU Activity Management	18
2.2.13	Remote SIM	18
2.2.14	Modem Config Management	18
2.2.15	Sensors	19
2.2.16	Platform	19
2.2.17	Remote SIM Provisioning	19
2.2.18	Debug Logger	20
2.2.19	WLAN Management	20
2.2.20	Diagnostic Services	20
2.3	Subsystem Restart	21
2.3.1	Data Services	21
2.4	Security	21
2.4.1	SELinux	22
<b>3</b>	<b>Call Flow Diagrams</b>	<b>25</b>
3.1	Application initialization call flow	25
3.1.1	Phone manager initialization	25
3.2	Telephony	26



3.2.1	Dial call flow	26
3.2.2	ECall call flow	28
3.2.3	TPS eCall over IMS call flow	30
3.2.4	Answer, Reject, RejectWithSMS call flow	32
3.2.5	Hold call flow	33
3.2.6	Hold, Conference, Swap call flow	34
3.2.7	SMS call flow	36
3.2.8	Signal strength call flow	37
3.2.9	CellBroadcast Call Flow	38
3.2.10	Radio and Service state call flow	39
3.2.11	Network Selection Manager call flow	41
3.2.12	Serving System Manager Call Flow	43
3.2.13	Card-Get applications call flow	45
3.2.14	Card-Transmit APDU call flow	46
3.2.14.1	On logical channel	46
3.2.14.2	On basic channel	47
3.2.15	SAP card manager call flow	47
3.2.15.1	Request card reader status, Request ATR, Transmit APDU call flow	48
3.2.15.2	SIM Turn off, Turn on and Reset call flow	50
3.2.16	Subscription Call flow	51
3.2.16.1	Subscription initialization	51
3.2.16.2	Subscription call flow	52
3.2.17	Remote SIM Provisioning Call Flow	52
3.2.17.1	Download and deletion of profile call flow	53
3.2.17.2	SIM profile management operations call flow	55
3.2.17.3	HttpTransaction subsystem readiness and handling of indication from mo-dem call flow	57
3.2.18	Remote SIM	58
3.3	Location Services	60
3.3.1	Call flow to register/remove listener for generating basic reports	61
3.3.2	Call flow to register/remove listener for generating detailed reports	62
3.3.3	Call flow to register/remove listener for generating detailed engine reports	64
3.3.4	Call flow to register/remove listener for system info updates	65
3.3.5	Call flow to request energy consumed information	66
3.3.6	Call flow to get year of hardware information	67
3.3.7	Call flow to get terrestrial positioning information	67
3.3.8	Call flow to cancel terrestrial positioning information	68
3.3.9	Call flow to enable/disable constraint time uncertainty	68
3.3.10	Call flow to enable/disable PACE	69
3.3.11	Call flow to delete all aiding data	69
3.3.12	Call flow to configure lever arm parameters	70
3.3.13	Call flow to configure blacklisted constellations	70
3.3.14	Call flow to configure robust location	71
3.3.15	Call flow to configure min gps week	71
3.3.16	Call flow to request min gps week	72
3.3.17	Call flow to delete specified data	72
3.3.18	Call flow to configure min sv elevation	73
3.3.19	Call flow to request min sv elevation	73
3.3.20	Call flow to request robust location	74
3.3.21	Call flow to configure dead reckoning engine	74

3.3.22	Call flow to configure secondary band	75
3.3.23	Call flow to request secondary band	75
3.3.24	Call flow to configure engine state	76
3.3.25	Call flow to provide user consent for terrestrial positioning	76
3.3.26	Call flow to configure NMEA sentence type	77
3.3.27	Call flow to represent Xtra Feature	78
3.3.28	Call flow to inject RTCM correction data with dgns manager	79
3.4	Data Services	79
3.4.1	Start/Stop for data connection manager call flow	80
3.4.2	Request data profile list call flow	82
3.4.3	Data Serving System Manager Call Flow	83
3.4.3.1	Get Dedicated Radio Bearer Call Flow	83
3.4.3.2	Request Service Status Call Flow	84
3.4.3.3	Request Roaming Status Call Flow	85
3.4.4	Data Filter Manager Call Flow	85
3.4.4.1	Call flow to Set/Get data filter mode	86
3.4.4.2	Call flow to Add data restrict filter	87
3.4.4.3	Call flow to Remove data restrict filter	88
3.4.5	Data Networking Call Flow	89
3.4.5.1	Create VLAN and Bind it to PDN in data vlan manager call flow	90
3.4.5.2	LAN-LAN VLAN Configuration from EAP usecase call flow	91
3.4.5.3	LAN-LAN VLAN Configuration from A7 usecase call flow	93
3.4.5.4	LAN-WAN VLAN Configuration from EAP usecase call flow	94
3.4.5.5	LAN-WAN VLAN Configuration from A7 usecase call flow	97
3.4.5.6	Create Static NAT entry in data Static NAT manager call flow	99
3.4.5.7	Firewall Enablement in data Firewall manager call flow	100
3.4.5.8	Add Firewall Entry in data Firewall manager call flow	101
3.4.5.9	Set Firewall DMZ in data Firewall manager call flow	102
3.4.5.10	Socks Enablement in data Socks manager call flow	103
3.4.5.11	L2TP Enablement and Configuration in data L2TP manager call flow	105
3.4.5.12	Call flow to add and enable software bridge	107
3.4.5.13	Call flow to remove and disable software bridge	108
3.5	C-V2X	109
3.5.1	Retrieve/Update C-V2X Configuration	110
3.5.2	Start/Stop C-V2X Mode	113
3.5.3	C-V2X Radio Control Flow	115
3.5.4	C-V2X Radio Initialization	118
3.5.5	Get C-V2X Status	120
3.5.6	Get C-V2X Capabilities	122
3.5.7	C-V2X Radio RX Subscription	124
3.5.8	C-V2X Radio TX Event Flow	127
3.5.9	C-V2X Radio TX SPS flow	129
3.5.10	C-V2X Throttle Manager Filer rate adjustment notification flow	131
3.5.11	C-V2X Throttle Manager set verification load flow	131
3.5.12	C-V2X TX Status Report	132
3.5.13	C-V2X RX Meta Data	134
3.6	Audio	137
3.6.1	Audio Manager API call flow	137
3.6.2	Audio Voice Call Start/Stop call flow	139
3.6.3	Audio Voice Call Device Switch call flow	141

3.6.4	Audio Voice Call Volume/Mute control call flow . . . . .	143
3.6.5	Call flow to play DTMF tone . . . . .	145
3.6.6	Call flow to detect DTMF tones . . . . .	147
3.6.7	Audio Playback call flow . . . . .	149
3.6.8	Audio Capture call flow . . . . .	151
3.6.9	Audio Tone Generator call flow . . . . .	153
3.6.10	Audio Loopback call flow . . . . .	154
3.6.11	Compressed audio format playback call flow . . . . .	156
3.6.12	Audio Transcoding Operation Callflow . . . . .	158
3.6.13	Compressed audio format playback on Voice Paths Callflow . . . . .	160
3.6.14	Audio Subsystem Restart Callflow . . . . .	162
3.6.15	Audio calibration configuration status . . . . .	163
3.7	Thermal . . . . .	163
3.7.1	Thermal Manager API call flow . . . . .	164
3.7.2	Call flow to register/remove listener for Thermal manager notifications. . . . .	166
3.7.3	Thermal shutdown management . . . . .	167
3.7.3.1	Call flow to register/remove listener for Thermal auto-shutdown mode updates. . . . .	168
3.7.3.2	Call flow to set/get the Thermal auto-shutdown mode . . . . .	169
3.7.3.3	Call flow to manage thermal auto-shutdown from an eCall application. . . . .	171
3.8	TCU Activity Management . . . . .	172
3.8.1	Call flow to register/remove listener for TCU-activity manager . . . . .	174
3.8.2	Call flow to set the TCU-activity state . . . . .	176
3.9	Modem Config . . . . .	177
3.9.1	Call flow to load and activate a modem config file. . . . .	178
3.9.2	Call flow to deactivate and delete a modem config file. . . . .	179
3.9.3	Call flow to set and get config auto selection mode . . . . .	181
3.10	Sensor . . . . .	182
3.10.1	Call flow for sensor sub-system start-up . . . . .	182
3.10.2	Call flow for sensor data acquisition . . . . .	184
3.10.3	Call flow for sensor reconfiguration . . . . .	185
3.10.4	Call flow for sensor sub-system cleanup . . . . .	186
3.10.5	Call flow for sensor power control . . . . .	187
3.10.6	Call flow for sensor feature control . . . . .	188
3.11	Platform . . . . .	188
3.11.1	Call flow for EFS restore notification registration and handling . . . . .	190
3.11.2	Call flow of control filesystem for ECALL operation . . . . .	192
3.11.3	Call flow of control filesystem for OTA operation . . . . .	193
3.11.4	Call flow for sensor self test . . . . .	194
3.12	Security Management . . . . .	195
3.12.1	Crypto . . . . .	195
3.12.1.1	Call flow to generate and export key . . . . .	195
3.12.1.2	Call flow to sign and verify data . . . . .	196
3.12.1.3	Call flow to encrypt and decrypt data . . . . .	197
3.12.2	Crypto Accelerator . . . . .	197
3.12.2.1	Call flow for signature verification synchronous mode . . . . .	198
3.12.2.2	Call flow for signature verification asynchronous poll mode . . . . .	198
3.12.2.3	Call flow for signature verification asynchronous listener mode . . . . .	199
3.12.2.4	Call flow for ECQV calculation synchronous mode . . . . .	200
3.12.2.5	Call flow for ECQV calculation asynchronous poll mode . . . . .	200
3.12.2.6	Call flow for ECQV calculation asynchronous listener mode . . . . .	201

3.12.3 Cellular Connection Security	201
3.12.3.1 Call flow to register listener and receive reports	202
3.12.4 Wifi connection security	202
3.12.4.1 Call flow to register listener and receive reports	203
3.13 WLAN	203
3.13.1 Call flow to modify WLAN configuration	204
3.13.2 Call flow to modify WLAN station configuration	206
3.13.3 Call flow to Modify WLAN Access Point Configuration	207
3.14 Diagnostics	208
3.14.1 Call flow to collect logs using file method	209
3.14.2 Call flow to collect logs using callback method	211
<b>4 Interfaces</b>	<b>213</b>
4.1 Telematics SDK APIs	213
4.2 Telephony	214
4.3 Phone	215
4.3.1 Data Structure Documentation	215
4.3.1.1 class telux::tel::GsmCellIdentity	215
4.3.1.2 class telux::tel::CdmaCellIdentity	217
4.3.1.3 class telux::tel::LteCellIdentity	218
4.3.1.4 class telux::tel::WcdmaCellIdentity	221
4.3.1.5 class telux::tel::TdscdmaCellIdentity	223
4.3.1.6 class telux::tel::Nr5gCellIdentity	225
4.3.1.7 class telux::tel::CellInfo	226
4.3.1.8 class telux::tel::GsmCellInfo	227
4.3.1.9 class telux::tel::CdmaCellInfo	228
4.3.1.10 class telux::tel::LteCellInfo	229
4.3.1.11 class telux::tel::WcdmaCellInfo	230
4.3.1.12 class telux::tel::TdscdmaCellInfo	231
4.3.1.13 class telux::tel::Nr5gCellInfo	232
4.3.1.14 struct telux::tel::ECallMsdOptionals	233
4.3.1.15 struct telux::tel::ECallMsdControlBits	234
4.3.1.16 struct telux::tel::ECallVehicleIdentificationNumber	234
4.3.1.17 struct telux::tel::ECallVehiclePropulsionStorageType	234
4.3.1.18 struct telux::tel::ECallVehicleLocation	235
4.3.1.19 struct telux::tel::ECallVehicleLocationDelta	235
4.3.1.20 struct telux::tel::ECallOptionalPdu	235
4.3.1.21 struct telux::tel::ECallMsdData	235
4.3.1.22 struct telux::tel::ECallModelInfo	236
4.3.1.23 struct telux::tel::ECallHlapTimerStatus	236
4.3.1.24 struct telux::tel::ECallHlapTimerEvents	237
4.3.1.25 struct telux::tel::CustomSipHeader	238
4.3.1.26 struct telux::tel::EcallConfig	238
4.3.1.27 class telux::tel::IPhone	238
4.3.1.28 class telux::tel::ISignalStrengthCallback	244
4.3.1.29 class telux::tel::IVoiceServiceStateCallback	245
4.3.1.30 struct telux::tel::SimRatCapability	246
4.3.1.31 struct telux::tel::CellularCapabilityInfo	246
4.3.1.32 struct telux::tel::SignalStrengthThreshold	247
4.3.1.33 struct telux::tel::SignalStrengthConfig	247

4.3.1.34	class telux::tel::PhoneFactory	247
4.3.1.35	class telux::tel::IPhoneListener	254
4.3.1.36	class telux::tel::IPhoneManager	257
4.3.1.37	class telux::tel::ICellularCapabilityCallback	262
4.3.1.38	class telux::tel::IOperatingModeCallback	262
4.3.1.39	class telux::tel::SignalStrength	263
4.3.1.40	class telux::tel::LteSignalStrengthInfo	265
4.3.1.41	class telux::tel::GsmSignalStrengthInfo	267
4.3.1.42	class telux::tel::CdmaSignalStrengthInfo	269
4.3.1.43	class telux::tel::WcdmaSignalStrengthInfo	270
4.3.1.44	class telux::tel::TdscdmaSignalStrengthInfo	272
4.3.1.45	class telux::tel::Nr5gSignalStrengthInfo	272
4.3.1.46	class telux::tel::VoiceServiceInfo	273
4.3.1.47	union telux::tel::SignalStrengthConfig.____unnamed____	275
4.3.2	Enumeration Type Documentation	275
4.3.2.1	CellType	275
4.3.2.2	ECallVariant	275
4.3.2.3	EmergencyCallType	275
4.3.2.4	ECallMsdTransmissionStatus	276
4.3.2.5	ECallCategory	276
4.3.2.6	ECallVehicleType	276
4.3.2.7	ECallOptionalDataType	277
4.3.2.8	ECallMode	277
4.3.2.9	ECallModeReason	277
4.3.2.10	HlapTimerStatus	277
4.3.2.11	HlapTimerEvent	278
4.3.2.12	HlapTimerType	278
4.3.2.13	ECallNumType	278
4.3.2.14	EcallConfigType	278
4.3.2.15	RadioState	279
4.3.2.16	ServiceState	279
4.3.2.17	RadioTechnology	279
4.3.2.18	RATCapability	280
4.3.2.19	VoiceServiceTechnology	280
4.3.2.20	OperatingMode	280
4.3.2.21	EcbMode	281
4.3.2.22	RadioSignalStrengthType	281
4.3.2.23	SignalStrengthConfigType	281
4.3.2.24	SignalStrengthLevel	281
4.3.2.25	VoiceServiceState	282
4.3.2.26	VoiceServiceDenialCause	282
4.3.3	Variable Documentation	283
4.3.3.1	CONTENT_HEADER	283
4.4	Call	284
4.4.1	Data Structure Documentation	284
4.4.1.1	class telux::tel::ICall	284
4.4.1.2	class telux::tel::ICallListener	291
4.4.1.3	class telux::tel::ICallManager	295
4.4.1.4	class telux::tel::IMakeCallCallback	310
4.4.2	Enumeration Type Documentation	311

4.4.2.1	CallDirection	311
4.4.2.2	CallState	311
4.4.2.3	CallEndCause	311
4.5	eCall	315
4.5.1	Data Structure Documentation	315
4.5.1.1	class telux::tel::IEcallManager	315
4.5.1.2	class telux::tel::IEcallListener	317
4.6	SMS	318
4.6.1	Data Structure Documentation	318
4.6.1.1	struct telux::tel::DeleteInfo	318
4.6.1.2	struct telux::tel::SmsMetaInfo	318
4.6.1.3	struct telux::tel::MessageAttributes	318
4.6.1.4	struct telux::tel::MessagePartInfo	319
4.6.1.5	class telux::tel::SmsMessage	319
4.6.1.6	class telux::tel::ISmsManager	321
4.6.1.7	class telux::tel::ISmsListener	329
4.6.1.8	class telux::tel::ISmscAddressCallback	331
4.6.2	Enumeration Type Documentation	331
4.6.2.1	SmsEncoding	331
4.6.2.2	SmsTagType	332
4.6.2.3	DeleteType	332
4.6.2.4	StorageType	332
4.7	SIM Card Services	333
4.7.1	Data Structure Documentation	333
4.7.1.1	class telux::tel::ICardApp	333
4.7.1.2	struct telux::tel::IccResult	336
4.7.1.3	struct telux::tel::FileAttributes	337
4.7.1.4	class telux::tel::ICardFileHandler	337
4.7.1.5	class telux::tel::ICardManager	341
4.7.1.6	class telux::tel::ICard	344
4.7.1.7	class telux::tel::ICardChannelCallback	349
4.7.1.8	class telux::tel::ICardCommandCallback	350
4.7.1.9	class telux::tel::ICardListener	350
4.7.1.10	struct telux::tel::CardReaderStatus	351
4.7.1.11	class telux::tel::ISapCardManager	351
4.7.1.12	class telux::tel::IAtrResponseCallback	357
4.7.1.13	class telux::tel::ISapCardCommandCallback	357
4.7.1.14	class telux::tel::ICardReaderCallback	358
4.7.1.15	class telux::tel::ISapCardListener	358
4.7.2	Enumeration Type Documentation	359
4.7.2.1	CardState	359
4.7.2.2	CardError	359
4.7.2.3	CardLockType	359
4.7.2.4	AppType	360
4.7.2.5	AppState	360
4.7.2.6	EfType	360
4.7.2.7	SapState	360
4.7.2.8	SapCondition	361
4.8	Cell Broadcast	362
4.8.1	Data Structure Documentation	362

4.8.1.1	struct telux::tel::CellBroadcastFilter	362
4.8.1.2	struct telux::tel::Point	362
4.8.1.3	class telux::tel::Polygon	362
4.8.1.4	class telux::tel::Circle	363
4.8.1.5	class telux::tel::Geometry	364
4.8.1.6	class telux::tel::WarningAreaInfo	365
4.8.1.7	class telux::tel::EtwsInfo	366
4.8.1.8	class telux::tel::CmasInfo	369
4.8.1.9	class telux::tel::CellBroadcastMessage	373
4.8.1.10	class telux::tel::ICellBroadcastManager	374
4.8.1.11	class telux::tel::ICellBroadcastListener	378
4.8.2	Enumeration Type Documentation	379
4.8.2.1	GeographicalScope	379
4.8.2.2	MessagePriority	379
4.8.2.3	MessageType	379
4.8.2.4	EtwsWarningType	380
4.8.2.5	CmasMessageClass	380
4.8.2.6	CmasSeverity	380
4.8.2.7	CmasUrgency	380
4.8.2.8	CmasCertainty	381
4.8.2.9	GeometryType	381
4.9	IMS Settings	382
4.9.1	Data Structure Documentation	382
4.9.1.1	struct telux::tel::ImsServiceConfig	382
4.9.1.2	class telux::tel::ImsSettingsManager	382
4.9.1.3	class telux::tel::ImsSettingsListener	384
4.9.2	Enumeration Type Documentation	385
4.9.2.1	ImsServiceConfigType	385
4.10	Multi SIM	386
4.10.1	Data Structure Documentation	386
4.10.1.1	struct telux::tel::SlotStatus	386
4.10.1.2	class telux::tel::IMultiSimManager	386
4.10.1.3	class telux::tel::IMultiSimListener	390
4.10.2	Enumeration Type Documentation	391
4.10.2.1	SlotState	391
4.11	Subscription Management	392
4.11.1	Data Structure Documentation	392
4.11.1.1	class telux::tel::ISubscription	392
4.11.1.2	class telux::tel::ISubscriptionListener	395
4.11.1.3	class telux::tel::ISubscriptionManager	396
4.12	Network Selection	400
4.12.1	Data Structure Documentation	400
4.12.1.1	struct telux::tel::PreferredNetworkInfo	400
4.12.1.2	struct telux::tel::OperatorStatus	400
4.12.1.3	struct telux::tel::NetworkScanInfo	400
4.12.1.4	class telux::tel::INetworkSelectionManager	400
4.12.1.5	class telux::tel::OperatorInfo	405
4.12.1.6	class telux::tel::INetworkSelectionListener	407
4.12.2	Enumeration Type Documentation	408
4.12.2.1	RatType	408

4.12.2.2	NetworkScanStatus	408
4.12.2.3	NetworkSelectionMode	408
4.12.2.4	InUseStatus	409
4.12.2.5	RoamingStatus	409
4.12.2.6	ForbiddenStatus	409
4.12.2.7	PreferredStatus	409
4.12.2.8	NetworkScanType	409
4.13	Serving System	410
4.13.1	Data Structure Documentation	410
4.13.1.1	struct telux::tel::ServingSystemInfo	410
4.13.1.2	struct telux::tel::RFBandInfo	410
4.13.1.3	struct telux::tel::DcStatus	410
4.13.1.4	struct telux::tel::NetworkTimeInfo	410
4.13.1.5	class telux::tel::IServingSystemManager	411
4.13.1.6	class telux::tel::IServingSystemListener	417
4.13.2	Enumeration Type Documentation	419
4.13.2.1	ServiceDomainPreference	419
4.13.2.2	ServiceDomain	419
4.13.2.3	RFBand	419
4.13.2.4	RFBandWidth	423
4.13.2.5	RatPrefType	423
4.13.2.6	EndcAvailability	424
4.13.2.7	DcnrRestriction	424
4.13.2.8	ServingSystemNotificationType	424
4.14	Remote SIM Provisioning	425
4.14.1	Data Structure Documentation	425
4.14.1.1	struct telux::tel::CustomHeader	425
4.14.1.2	class telux::tel::IHttpTransactionListener	425
4.14.1.3	class telux::tel::IHttpTransactionManager	426
4.14.1.4	class telux::tel::SimProfile	428
4.14.1.5	class telux::tel::ISimProfileListener	431
4.14.1.6	class telux::tel::ISimProfileManager	432
4.14.2	Enumeration Type Documentation	440
4.14.2.1	HttpResult	440
4.14.2.2	ProfileType	440
4.14.2.3	IconType	440
4.14.2.4	ProfileClass	440
4.14.2.5	DownloadStatus	441
4.14.2.6	DownloadErrorCause	441
4.14.2.7	UserConsentReasonType	441
4.14.2.8	PolicyRuleType	441
4.14.2.9	ResetOption	441
4.15	Remote SIM	442
4.15.1	Data Structure Documentation	442
4.15.1.1	class telux::tel::IRemoteSimListener	442
4.15.1.2	class telux::tel::IRemoteSimManager	443
4.15.2	Enumeration Type Documentation	449
4.15.2.1	CardErrorCause	449
4.16	Supplementary Services	450
4.16.1	Data Structure Documentation	450



4.16.1.1	class telux::tel::ISuppServicesListener	450
4.16.1.2	struct telux::tel::ForwardInfo	450
4.16.1.3	struct telux::tel::ForwardReq	450
4.16.1.4	class telux::tel::ISuppServicesManager	451
4.16.2	Enumeration Type Documentation	456
4.16.2.1	SuppServicesStatus	456
4.16.2.2	SuppSvcProvisionStatus	456
4.16.2.3	ForwardOperation	456
4.16.2.4	ForwardReason	456
4.16.2.5	ServiceClassType	457
4.16.2.6	FailureCause	457
4.17	Location	463
4.18	Location Services	464
4.18.1	Data Structure Documentation	464
4.18.1.1	class telux::loc::IDgnssStatusListener	464
4.18.1.2	class telux::loc::IDgnssManager	464
4.18.1.3	class telux::loc::ILocationConfigurator	467
4.18.1.4	struct telux::loc::GnssKinematicsData	483
4.18.1.5	struct telux::loc::LLAInfo	484
4.18.1.6	struct telux::loc::TimeInfo	485
4.18.1.7	struct telux::loc::GlonassTimeInfo	485
4.18.1.8	union telux::loc::SystemTimeInfo	486
4.18.1.9	struct telux::loc::SystemTime	486
4.18.1.10	struct telux::loc::GnssMeasurementInfo	486
4.18.1.11	struct telux::loc::SvUsedInPosition	487
4.18.1.12	struct telux::loc::GnssData	487
4.18.1.13	struct telux::loc::SvBlackListInfo	488
4.18.1.14	struct telux::loc::LeverArmParams	488
4.18.1.15	struct telux::loc::GnssMeasurementsData	488
4.18.1.16	struct telux::loc::GnssMeasurementsClock	490
4.18.1.17	struct telux::loc::GnssMeasurements	490
4.18.1.18	struct telux::loc::GnssDisasterCrisisReport	491
4.18.1.19	struct telux::loc::LeapSecondChangeInfo	491
4.18.1.20	struct telux::loc::LeapSecondInfo	491
4.18.1.21	struct telux::loc::LocationSystemInfo	492
4.18.1.22	struct telux::loc::GnssEnergyConsumedInfo	492
4.18.1.23	struct telux::loc::NmeaConfig	492
4.18.1.24	struct telux::loc::RobustLocationVersion	493
4.18.1.25	struct telux::loc::RobustLocationConfiguration	493
4.18.1.26	struct telux::loc::BodyToSensorMountParams	493
4.18.1.27	struct telux::loc::DREngineConfiguration	494
4.18.1.28	struct telux::loc::XtraConfig	495
4.18.1.29	struct telux::loc::XtraStatus	496
4.18.1.30	class telux::loc::ILocationInfoBase	496
4.18.1.31	class telux::loc::ILocationInfoEx	500
4.18.1.32	class telux::loc::ISVInfo	510
4.18.1.33	class telux::loc::IGnssSVInfo	513
4.18.1.34	class telux::loc::IGnssSignalInfo	514
4.18.1.35	class telux::loc::LocationFactory	514
4.18.1.36	class telux::loc::ILocationListener	516

4.18.1.37 class telux::loc::ILocationSystemInfoListener	520
4.18.1.38 class telux::loc::ILocationConfigListener	521
4.18.1.39 class telux::loc::ILocationManager	522
4.18.2 Enumeration Type Documentation	531
4.18.2.1 DgnssDataFormat	531
4.18.2.2 DgnssStatus	531
4.18.2.3 HorizontalAccuracyLevel	532
4.18.2.4 LocationReliability	532
4.18.2.5 SbasCorrectionType	532
4.18.2.6 AltitudeType	533
4.18.2.7 GnssConstellationType	533
4.18.2.8 SVHealthStatus	533
4.18.2.9 SVStatus	534
4.18.2.10 SVInfoAvailability	534
4.18.2.11 GnssPositionTechType	534
4.18.2.12 KinematicDataValidityType	534
4.18.2.13 GnssSystem	535
4.18.2.14 GnssTimeValidityType	535
4.18.2.15 GlonassTimeValidity	536
4.18.2.16 GnssSignalType	536
4.18.2.17 LocCapabilityType	536
4.18.2.18 LocationTechnologyType	537
4.18.2.19 LocationValidityType	538
4.18.2.20 LocationInfoExValidityType	538
4.18.2.21 GnssDataSignalTypes	539
4.18.2.22 GnssDataValidityType	539
4.18.2.23 DrCalibrationStatusType	540
4.18.2.24 DrSolutionStatusType	540
4.18.2.25 LocReqEngineType	541
4.18.2.26 LocationAggregationType	541
4.18.2.27 PositioningEngineType	541
4.18.2.28 LeverArmType	542
4.18.2.29 GnssMeasurementsDataValidityType	542
4.18.2.30 GnssMeasurementsStateValidityType	543
4.18.2.31 GnssMeasurementsAdrStateValidityType	543
4.18.2.32 GnssMeasurementsMultipathIndicator	543
4.18.2.33 GnssMeasurementsClockValidityType	543
4.18.2.34 GnssReportDCType	544
4.18.2.35 LeapSecondInfoValidityType	544
4.18.2.36 LocationSystemInfoValidityType	544
4.18.2.37 GnssEnergyConsumedInfoValidityType	544
4.18.2.38 AidingDataType	545
4.18.2.39 TerrestrialTechnologyType	545
4.18.2.40 NmeaSentenceType	545
4.18.2.41 GeodeticDatumType	545
4.18.2.42 RobustLocationConfigType	546
4.18.2.43 DRConfigValidityType	546
4.18.2.44 GnssReportType	546
4.18.2.45 EngineType	547
4.18.2.46 LocationEngineRunState	547

4.18.2.47 ReportStatus . . . . .	547
4.18.2.48 DebugLogLevel . . . . .	547
4.18.2.49 XtraDataStatus . . . . .	548
4.18.2.50 LocConfigIndicationsType . . . . .	548
4.18.3 Variable Documentation . . . . .	548
4.18.3.1 UNKNOWN_CARRIER_FREQ . . . . .	548
4.18.3.2 UNKNOWN_SIGNAL_MASK . . . . .	548
4.18.3.3 UNKNOWN_BASEBAND_CARRIER_NOISE . . . . .	548
4.18.3.4 UNKNOWN_TIMESTAMP . . . . .	548
4.18.3.5 DEFAULT_TUNC_THRESHOLD . . . . .	548
4.18.3.6 DEFAULT_TUNC_ENERGY_THRESHOLD . . . . .	549
4.18.3.7 INVALID_ENERGY_CONSUMED . . . . .	549
4.18.3.8 UNKNOWN_SV_TIME_SUB_NS . . . . .	549
4.18.3.9 DEFAULT_GNSS_REPORT . . . . .	549
4.19 Common . . . . .	550
4.19.1 Data Structure Documentation . . . . .	550
4.19.1.1 class telux::common::ICommandCallback . . . . .	550
4.19.1.2 class telux::common::ICommandResponseCallback . . . . .	550
4.19.1.3 class telux::common::DeviceConfig . . . . .	551
4.19.1.4 class telux::common::Log . . . . .	551
4.19.1.5 struct telux::common::SdkVersion . . . . .	552
4.19.1.6 class telux::common::Version . . . . .	552
4.19.2 Enumeration Type Documentation . . . . .	553
4.19.2.1 Status . . . . .	553
4.19.2.2 ErrorCode . . . . .	553
4.19.2.3 ServiceStatus . . . . .	559
4.19.2.4 ProcType . . . . .	559
4.19.2.5 LogLevel . . . . .	560
4.20C APIs . . . . .	561
4.21C Common APIs . . . . .	562
4.21.1 Data Structure Documentation . . . . .	562
4.21.1.1 struct v2x_api_ver_t . . . . .	562
4.21.2 Enumeration Type Documentation . . . . .	562
4.21.2.1 v2x_status_enum_type . . . . .	562
4.22C Kinematics APIs . . . . .	563
4.22.1 Define Documentation . . . . .	563
4.22.1.1 V2X_KINEMATICS_HANDLE_BAD . . . . .	563
4.22.2 Data Structure Documentation . . . . .	563
4.22.2.1 struct v2x_GNSSstatus_t . . . . .	563
4.22.2.2 struct v2x_gnss_fix_rates_supported_list_t . . . . .	564
4.22.2.3 struct v2x_init_t . . . . .	564
4.22.2.4 struct v2x_kinematics_capabilities_t_feature_flags_t . . . . .	565
4.22.2.5 struct v2x_rates_t . . . . .	566
4.22.2.6 struct v2x_kinematics_capabilities_t . . . . .	566
4.22.2.7 struct v2x_location_fix_t . . . . .	567
4.22.3 Enumeration Type Documentation . . . . .	570
4.22.3.1 v2x_fix_mode_t . . . . .	570
4.22.4 Function Documentation . . . . .	570
4.22.4.1 v2x_kinematics_api_version(void) . . . . .	570

4.22.4.2	v2x_kinematics_init(v2x_init_t *param, v2x_kinematics_init_callback_t cb, void *context)	571
4.22.4.3	v2x_kinematics_start_rate_notification(v2x_kinematics_handle_t handle, v2x_kinematics_rate_notification_listener_t cb, void *context)	572
4.22.4.4	v2x_kinematics_set_rate(v2x_kinematics_handle_t handle, v2x_rates_t *rate, v2x_kinematics_set_rate_callback_t cb, void *context)	573
4.22.4.5	v2x_kinematics_register_listener(v2x_kinematics_handle_t handle, v2x_kinematics_newfix_listener_t listener, void *context)	574
4.22.4.6	v2x_kinematics_deregister_listener(v2x_kinematics_handle_t handle, v2x_kinematics_deregister_callback_t cb, void *context)	575
4.22.4.7	v2x_kinematics_final(v2x_kinematics_handle_t handle, v2x_kinematics_final_callback_t cb, void *context)	576
4.22.4.8	v2x_kinematics_enable_fixes(v2x_kinematics_handle_t handle)	577
4.22.4.9	v2x_kinematics_disable_fixes(v2x_kinematics_handle_t handle)	577
4.23C	Radio APIs	578
4.23.1	Define Documentation	578
4.23.1.1	V2X_RADIO_HANDLE_BAD	578
4.23.1.2	V2X_MAX_RADIO_SESSIONS	578
4.23.1.3	V2X_RX_WILDCARD_PORTNUM	578
4.23.1.4	MAX_POOL_IDS_LIST_LEN	578
4.23.1.5	MAX_MALICIOUS_IDS_LIST_LEN	578
4.23.1.6	MAX_TRUSTED_IDS_LIST_LEN	578
4.23.1.7	MAX_SUBSCRIBE_SIDS_LIST_LEN	578
4.23.1.8	MAX_FILTER_IDS_LIST_LEN	578
4.23.1.9	V2X_MAX_ANTENNAS_SUPPORTED	578
4.23.1.10	V2X_MAX_TX_POOL_NUM	579
4.23.1.11	V2X_MAX_RX_POOL_NUM	579
4.23.1.12	V2X_MAX_SLSS_SYNC_REF_UE_NUM	579
4.23.2	Data Structure Documentation	579
4.23.2.1	struct v2x_status_info_t	579
4.23.2.2	struct v2x_radio_status_t	579
4.23.2.3	struct v2x_pool_status_t	579
4.23.2.4	struct v2x_radio_status_ex_t	580
4.23.2.5	struct trusted_ue_info_t	580
4.23.2.6	struct tx_pool_id_info_t	580
4.23.2.7	struct v2x_iface_capabilities_t	582
4.23.2.8	struct v2x_tx_bandwidth_reservation_t	584
4.23.2.9	struct v2x_chan_meas_params_t	585
4.23.2.10	struct v2x_chan_measurements_t	585
4.23.2.11	struct v2x_radio_calls_t	586
4.23.2.12	struct v2x_sps_mac_details_t	589
4.23.2.13	struct v2x_per_sps_reservation_calls_t	590
4.23.2.14	struct v2x_slss_sync_ref_ue_info_t	592
4.23.2.15	struct v2x_slss_rx_info_t	592
4.23.2.16	struct v2x_tx_flow_info_t	592
4.23.2.17	struct v2x_sock_info_t	593
4.23.2.18	struct v2x_sid_list_t	593
4.23.2.19	struct v2x_tx_sps_flow_info_t	594
4.23.2.20	struct socket_info_t	594
4.23.2.21	struct src_l2_filter_info_t	594

4.23.2.22	struct v2x_rf_tx_info_t	594
4.23.2.23	struct v2x_tx_status_report_t	595
4.23.3	Enumeration Type Documentation	595
4.23.3.1	v2x_concurrency_sel_t	595
4.23.3.2	v2x_event_t	596
4.23.3.3	v2x_priority_et	597
4.23.3.4	v2x_service_status_t	597
4.23.3.5	v2x_radio_status_type_t	597
4.23.3.6	v2x_radio_cause_type_t	597
4.23.3.7	v2x_auto_retransmit_policy_t	598
4.23.3.8	v2x_slss_sync_pattern_t	598
4.23.3.9	traffic_ip_type_t	599
4.23.3.10	rf_status_t	600
4.23.3.11	v2x_segment_type_t	600
4.23.3.12	v2x_tx_type_t	600
4.23.4	Function Documentation	600
4.23.4.1	v2x_convert_priority_to_traffic_class(v2x_priority_et priority)	600
4.23.4.2	v2x_convert_traffic_class_to_priority(uint16_t traffic_class)	602
4.23.4.3	v2x_radio_api_version()	602
4.23.4.4	v2x_radio_query_capabilities(v2x_iface_capabilities_t *caps)	603
4.23.4.5	v2x_radio_deinit(v2x_radio_handle_t handle)	603
4.23.4.6	v2x_radio_rx_sock_create_and_bind(v2x_radio_handle_t handle, int *sock, struct sockaddr_in6 *rx_sockaddr)	604
4.23.4.7	v2x_radio_rx_sock_create_and_bind_v2(v2x_radio_handle_t handle, int id↔_ist_len, uint32_t *id_list, int *sock, struct sockaddr_in6 *rx_sockaddr)	605
4.23.4.8	v2x_radio_rx_sock_create_and_bind_v3(v2x_radio_handle_t handle, uint16↔_t port_num, int id_ist_len, uint32_t *id_list, int *sock, struct sockaddr_in6 *rx_sockaddr)	607
4.23.4.9	v2x_radio_enable_rx_meta_data(v2x_radio_handle_t handle, bool enable, int id_list_len, uint32_t *id_list)	609
4.23.4.10	v2x_radio_sock_create_and_bind(v2x_radio_handle_t handle, v2x_tx_sps↔_flow_info_t *tx_flow_info, v2x_per_sps_reservation_calls_t *calls, int tx↔_sps_portnum, int tx_event_portnum, int rx_portnum, v2x_sid_list_t *rx_id↔_list, v2x_sock_info_t *tx_sps_sock, v2x_sock_info_t *tx_event_sock, v2x↔_sock_info_t *rx_sock)	609
4.23.4.11	v2x_radio_tx_sps_sock_create_and_bind(v2x_radio_handle_t handle, v2x↔_tx_bandwidth_reservation_t *res, v2x_per_sps_reservation_calls_t *calls, int sps_portnum, int event_portnum, int *sps_sock, struct sockaddr_in6 *sps↔_sockaddr, int *event_sock, struct sockaddr_in6 *event_sockaddr)	612
4.23.4.12	v2x_radio_tx_sps_only_create(v2x_radio_handle_t handle, v2x_tx_bandwidth↔_reservation_t *res, v2x_per_sps_reservation_calls_t *calls, int sps_portnum, int *sps_sock, struct sockaddr_in6 *sps_sockaddr)	614
4.23.4.13	v2x_radio_tx_reservation_change(int *sps_sock, v2x_tx_bandwidth_reservation↔_t *updated_reservation)	616
4.23.4.14	v2x_radio_tx_event_sock_create_and_bind(const char *interface, int v2x↔_id, int event_portnum, struct sockaddr_in6 *event_sock_addr, int *sock)	617
4.23.4.15	v2x_radio_start_measurements(v2x_radio_handle_t handle, v2x_chan↔_meas_params_t *measure_this_way)	618
4.23.4.16	v2x_radio_stop_measurements(v2x_radio_handle_t handle)	619
4.23.4.17	v2x_radio_sock_close(int *sock_fd)	620

4.23.4.18	v2x_radio_set_log_level(int new_level, int use_syslog)	621
4.23.4.19	cv2x_status_poll(uint64_t *status_age_useconds)	621
4.23.4.20	v2x_radio_trigger_l2_update(v2x_radio_handle_t handle)	622
4.23.4.21	v2x_radio_update_trusted_ue_list(unsigned int malicious_list_len, unsigned int malicious_list[MAX_MALICIOUS_IDS_LIST_LEN], unsigned int trusted_list_len, trusted_ue_info_t trusted_list[MAX_TRUSTED_IDS_LIST_LEN])	623
4.23.4.22	v2x_radio_tx_sps_sock_create_and_bind_v2(v2x_radio_handle_t handle, v2x_tx_sps_flow_info_t *sps_flow_info, v2x_per_sps_reservation_calls_t *calls, int sps_portnum, int event_portnum, int *sps_sock, struct sockaddr_in6 *sps_sockaddr, int *event_sock, struct sockaddr_in6 *event_sockaddr)	624
4.23.4.23	v2x_radio_tx_sps_only_create_v2(v2x_radio_handle_t handle, v2x_tx_sps_flow_info_t *sps_flow_info, v2x_per_sps_reservation_calls_t *calls, int sps_portnum, int *sps_sock, struct sockaddr_in6 *sps_sockaddr)	627
4.23.4.24	v2x_radio_tx_reservation_change_v2(int *sps_sock, v2x_tx_sps_flow_info_t *updated_flow_info)	630
4.23.4.25	v2x_radio_tx_event_flow_info_change(int *sock, v2x_tx_flow_info_t *updated_flow_info)	631
4.23.4.26	start_v2x_mode()	632
4.23.4.27	stop_v2x_mode()	632
4.23.4.28	v2x_radio_init_v2(traffic_ip_type_t ip_type, v2x_concurrency_sel_t mode, v2x_radio_calls_t *callbacks_p, void *ctx_p)	633
4.23.4.29	v2x_radio_init_v3(v2x_concurrency_sel_t mode, v2x_radio_calls_t *callbacks_p, void *ctx_p, v2x_radio_handle_t *ip_handle_p, v2x_radio_handle_t *non_ip_handle_p)	634
4.23.4.30	v2x_radio_tx_event_sock_create_and_bind_v3(traffic_ip_type_t ip_type, int v2x_id, int event_portnum, v2x_tx_flow_info_t *event_flow_info, struct sockaddr_in6 *event_sockaddr, int *sock)	635
4.23.4.31	get_iface_name(traffic_ip_type_t ip_type, char *iface_name, size_t buffer_len)	636
4.23.4.32	v2x_radio_tcp_sock_create_and_bind(v2x_radio_handle_t handle, const v2x_tx_flow_info_t *event_info, const socket_info_t *sock_info, int *sock_fd, struct sockaddr_in6 *sockaddr)	637
4.23.4.33	v2x_set_peak_tx_power(int8_t txPower)	639
4.23.4.34	v2x_set_l2_filters(uint32_t list_len, src_l2_filter_info *list_array)	639
4.23.4.35	v2x_remove_l2_filters(uint32_t list_len, uint32_t *l2_id_list)	639
4.23.4.36	v2x_register_tx_status_report_listener(uint16_t port, v2x_tx_status_report_listener callback)	640
4.23.4.37	v2x_deregister_tx_status_report_listener(uint16_t port)	640
4.23.4.38	v2x_set_global_IPaddr(uint8_t prefix_len, uint8_t *ipv6_addr)	642
4.23.4.39	v2x_set_ip_routing_info(uint8_t *dest_mac_addr)	642
4.23.4.40	v2x_get_ext_radio_status(v2x_radio_status_ex_t *status)	642
4.23.4.41	v2x_register_ext_radio_status_listener(v2x_ext_radio_status_listener callback)	643
4.23.4.42	v2x_get_slss_rx_info(v2x_slss_rx_info_t *slss_info)	643
4.23.4.43	v2x_register_slss_rx_listener(v2x_slss_rx_listener callback)	643
4.23.4.44	v2x_deregister_slss_rx_listener(v2x_slss_rx_listener callback)	644
4.23.4.45	v2x_inject_coarse_utc_time(uint64_t utc)	644
4.24C	Vehicle APIs	645
4.24.1	Define Documentation	645
4.24.1.1	V2X_VDATA_HANDLE_BAD	645
4.24.1.2	V2X_J2735_TRACTION_CONTROL_MAX	645

4.24.1.3	V2X_TRACTION_CTRL_MAX	645
4.24.1.4	J2735_ABS_MAX	645
4.24.1.5	V2X_STABILITY_CONTROL_MAX	645
4.24.1.6	V2X_AUX_BRAKE_MAX	645
4.24.2	Data Structure Documentation	646
4.24.2.1	union v2x_control_status_ut	646
4.24.2.2	struct v2x_control_status_ut.bits	646
4.24.2.3	union vehicleEventFlags_ut	647
4.24.2.4	struct vehicleEventFlags_ut.bits	648
4.24.2.5	union ExteriorLights_ut	649
4.24.2.6	struct ExteriorLights_ut.bits	649
4.24.2.7	struct high_resolution_motion_t	650
4.24.2.8	struct current_dynamic_vehicle_state_t	651
4.24.2.9	struct static_vehicle_parameters_t	651
4.24.3	Enumeration Type Documentation	653
4.24.3.1	v2x_transmission_state_enum_type	653
4.24.3.2	v2x_BrakeBoostApplied_enum_type	653
4.24.3.3	v2x_TractionControlStatus_enum_type	653
4.24.3.4	v2x_AntiLockBrakeStatus_enum_type	654
4.24.3.5	v2x_StabilityControlStatus_enum_type	654
4.24.3.6	v2x_AuxBrakeStatus_enum_type	654
4.24.4	Function Documentation	655
4.24.4.1	v2x_vehicle_api_version(void)	655
4.24.4.2	v2x_vehicle_get_static_params(static_vehicle_parameters_t *parameters)	655
4.24.4.3	v2x_high_res_motion_register_listener(v2x_high_res_motion_listener_t cb)	656
4.24.4.4	v2x_high_res_motion_deregister_listener(v2x_motion_data_handle_t handle)	656
4.24.4.5	v2x_vehicle_register_listener(v2x_vehicle_event_listener_t cb, void *context)	657
4.24.4.6	v2x_vehicle_deregister_for_callback(v2x_vehicle_handle_t handle)	657
4.25C	Config APIs	658
4.25.1	Data Structure Documentation	658
4.25.1.1	struct v2x_config_event_info_t	658
4.25.2	Enumeration Type Documentation	659
4.25.2.1	v2x_config_soure_t	659
4.25.2.2	v2x_config_event_t	659
4.25.3	Function Documentation	659
4.25.3.1	v2x_register_for_config_change_ind(cv2x_config_event_listener callback)	659
4.25.3.2	v2x_update_configuration(const char *config_file_path)	661
4.25.3.3	v2x_retrieve_configuration(const char *config_file_path)	662
4.26C	Packet APIs	663
4.26.1	Define Documentation	663
4.26.1.1	META_DATA_MASK_SFN	663
4.26.1.2	META_DATA_MASK_SUB_CHANNEL_INDEX	663
4.26.1.3	META_DATA_MASK_SUB_CHANNEL_NUM	663
4.26.1.4	META_DATA_MASK_PRX_RSSI	663
4.26.1.5	META_DATA_MASK_DRX_RSSI	663
4.26.1.6	META_DATA_MASK_L2_DEST	663
4.26.1.7	META_DATA_MASK_SCI_FORMAT1	663
4.26.1.8	META_DATA_MASK_DELAY_ESTI	663
4.26.2	Data Structure Documentation	663
4.26.2.1	struct rx_packet_meta_data_t	663



4.26.3	Function Documentation	664
4.26.3.1	v2x_parse_rx_meta_data(const uint8_t *payload, uint32_t length, rx_packet↔ _meta_data_t *meta_data, size_t *num, size_t *meta_data_len)	664
4.27	CPP APIs	665
4.27.1	Data Structure Documentation	665
4.27.1.1	class telux::cv2x::ICv2xConfigListener	665
4.27.1.2	class telux::cv2x::ICv2xConfig	665
4.27.1.3	class telux::cv2x::Cv2xFactory	668
4.27.1.4	class telux::cv2x::ICv2xRadio	669
4.27.1.5	class telux::cv2x::ICv2xRadioListener	682
4.27.1.6	class telux::cv2x::ICv2xRadioManager	685
4.27.1.7	struct telux::cv2x::SyncRefUeInfo	691
4.27.1.8	struct telux::cv2x::SlssRxInfo	691
4.27.1.9	struct telux::cv2x::SocketInfo	691
4.27.1.10	struct telux::cv2x::Cv2xStatus	691
4.27.1.11	struct telux::cv2x::Cv2xPoolStatus	692
4.27.1.12	struct telux::cv2x::Cv2xStatusEx	692
4.27.1.13	struct telux::cv2x::TxPoolIdInfo	693
4.27.1.14	struct telux::cv2x::EventFlowInfo	693
4.27.1.15	struct telux::cv2x::SpsFlowInfo	693
4.27.1.16	struct telux::cv2x::Cv2xRadioCapabilities	694
4.27.1.17	struct telux::cv2x::MacDetails	695
4.27.1.18	struct telux::cv2x::SpsSchedulingInfo	696
4.27.1.19	struct telux::cv2x::TrustedUEInfo	696
4.27.1.20	struct telux::cv2x::TrustedUEInfoList	697
4.27.1.21	struct telux::cv2x::IPv6Address	697
4.27.1.22	struct telux::cv2x::DataSessionSettings	697
4.27.1.23	struct telux::cv2x::ConfigEventInfo	697
4.27.1.24	struct telux::cv2x::L2FilterInfo	698
4.27.1.25	struct telux::cv2x::RFTxInfo	698
4.27.1.26	struct telux::cv2x::TxStatusReport	698
4.27.1.27	struct telux::cv2x::IPv6AddrType	699
4.27.1.28	struct telux::cv2x::GlobalIPUnicastRoutingInfo	699
4.27.1.29	struct telux::cv2x::RxPacketMetaDataReport	700
4.27.1.30	class telux::cv2x::Cv2xRxMetaDataHelper	700
4.27.1.31	class telux::cv2x::ICv2xRxSubscription	701
4.27.1.32	class telux::cv2x::ICv2xThrottleManagerListener	702
4.27.1.33	class telux::cv2x::ICv2xThrottleManager	704
4.27.1.34	class telux::cv2x::ICv2xTxFlow	705
4.27.1.35	class telux::cv2x::ICv2xTxRxSocket	707
4.27.1.36	class telux::cv2x::ICv2xTxStatusReportListener	708
4.27.1.37	class telux::cv2x::Cv2xUtil	709
4.27.1.38	struct telux::cv2x::prop::Position	710
4.27.1.39	struct telux::cv2x::prop::SubPERInterData	710
4.27.1.40	struct telux::cv2x::prop::PERInterData	710
4.27.1.41	struct telux::cv2x::prop::CongestionControlData	711
4.27.1.42	struct telux::cv2x::prop::ChannelData	711
4.27.1.43	struct telux::cv2x::prop::SpsEnhanceData	712
4.27.1.44	struct telux::cv2x::prop::TrackingErrorData	712
4.27.1.45	struct telux::cv2x::prop::CongestionControlCalculations	712



4.27.1.46	struct telux::cv2x::prop::CongestionControlUserData	713
4.27.1.47	struct telux::cv2x::prop::SPSEnhanceConfig	713
4.27.1.48	struct telux::cv2x::prop::DensityConfig	713
4.27.1.49	struct telux::cv2x::prop::PERConfig	714
4.27.1.50	struct telux::cv2x::prop::CQIConfig	714
4.27.1.51	struct telux::cv2x::prop::CBPConfig	714
4.27.1.52	struct telux::cv2x::prop::TEConfig	715
4.27.1.53	struct telux::cv2x::prop::ITTConfig	715
4.27.1.54	struct telux::cv2x::prop::PowerConfig	715
4.27.1.55	struct telux::cv2x::prop::CongestionControlConfig	716
4.27.1.56	class telux::cv2x::prop::CongestionControlUtility	716
4.27.1.57	class telux::cv2x::prop::ICongestionControlListener	717
4.27.1.58	class telux::cv2x::prop::ICongestionControlManager	718
4.27.1.59	class telux::cv2x::prop::CongestionControlUtil	729
4.27.1.60	class telux::cv2x::prop::V2xPropFactory	730
4.27.2	Enumeration Type Documentation	730
4.27.2.1	TrafficCategory	730
4.27.2.2	Cv2xStatusType	731
4.27.2.3	Cv2xCauseType	731
4.27.2.4	SlssSyncPattern	731
4.27.2.5	TrafficIpType	732
4.27.2.6	RadioConcurrencyMode	732
4.27.2.7	Cv2xEvent	732
4.27.2.8	Priority	732
4.27.2.9	Periodicity	733
4.27.2.10	ConfigSourceType	733
4.27.2.11	ConfigEvent	733
4.27.2.12	RFTxStatus	734
4.27.2.13	SegmentType	734
4.27.2.14	TxType	734
4.27.2.15	RxMetaDataValidityType	734
4.27.2.16	CCErrorCode	735
4.27.2.17	CongestionControlType	735
4.27.3	Function Documentation	735
4.27.3.1	printPosition(Position &position)	735
4.27.3.2	printChannelData(ChannelData &channelData)	735
4.27.3.3	printTrackingErrorData(TrackingErrorData &teData)	735
4.27.3.4	printSPSEnhanceConfig(SPSEnhanceConfig &spsEnhanceConfig)	736
4.27.3.5	printDensityConfig(DensityConfig &densConfig)	736
4.27.3.6	printPERConfig(PERConfig &perConfig)	736
4.27.3.7	printCQIConfig(CQIConfig &cqiConfig)	736
4.27.3.8	printCBPConfig(CBPConfig &cbpConfig)	736
4.27.3.9	printTEConfig(TEConfig &teConfig)	736
4.27.3.10	printITTConfig(ITTConfig &ittConfig)	737
4.27.3.11	printPowerConfig(PowerConfig &powerConfig)	737
4.27.4	Variable Documentation	737
4.27.4.1	MAX_ANTENNAS_SUPPORTED	737
4.28	Audio	738
4.28.1	Data Structure Documentation	738
4.28.1.1	class telux::audio::AudioFactory	738

4.29 Audio Manager	739
4.29.1 Data Structure Documentation	739
4.29.1.1 struct telux::audio::FormatParams	739
4.29.1.2 struct telux::audio::AmrwbpParams	739
4.29.1.3 struct telux::audio::StreamConfig	739
4.29.1.4 struct telux::audio::FormatInfo	740
4.29.1.5 class telux::audio::IAudioListener	741
4.29.1.6 class telux::audio::IAudioManager	741
4.29.1.7 class telux::audio::IAudioDevice	745
4.29.2 Enumeration Type Documentation	746
4.29.2.1 DeviceType	746
4.29.2.2 DeviceDirection	746
4.29.2.3 StreamType	747
4.29.2.4 StreamDirection	747
4.29.2.5 AmrwbpFrameFormat	747
4.29.2.6 EcnrMode	747
4.29.2.7 CalibrationInitStatus	747
4.30 Audio Streams	749
4.30.1 Data Structure Documentation	749
4.30.1.1 struct telux::audio::ChannelVolume	749
4.30.1.2 struct telux::audio::StreamVolume	749
4.30.1.3 struct telux::audio::StreamMute	749
4.30.1.4 struct telux::audio::DtmfTone	749
4.30.1.5 class telux::audio::IVoiceListener	750
4.30.1.6 class telux::audio::IPlayListener	750
4.30.1.7 class telux::audio::IAudioBuffer	751
4.30.1.8 class telux::audio::IStreamBuffer	753
4.30.1.9 class telux::audio::IAudioStream	753
4.30.1.10 class telux::audio::IAudioVoiceStream	756
4.30.1.11 class telux::audio::IAudioPlayStream	759
4.30.1.12 class telux::audio::IAudioCaptureStream	761
4.30.1.13 class telux::audio::IAudioLoopbackStream	762
4.30.1.14 class telux::audio::IAudioToneGeneratorStream	763
4.30.2 Enumeration Type Documentation	764
4.30.2.1 Direction	764
4.30.2.2 ChannelType	764
4.30.2.3 AudioFormat	764
4.30.2.4 DtmfLowFreq	765
4.30.2.5 DtmfHighFreq	765
4.30.2.6 StopType	765
4.31 Transcoder	766
4.31.1 Data Structure Documentation	766
4.31.1.1 class telux::audio::ITranscodeListener	766
4.31.1.2 class telux::audio::ITranscoder	766
4.32 Thermal	770
4.33 Thermal Management	771
4.33.1 Data Structure Documentation	771
4.33.1.1 class telux::therm::ThermalFactory	771
4.33.1.2 class telux::therm::IThermalListener	772
4.33.1.3 struct telux::therm::BoundCoolingDevice	773

4.33.1.4	class telux::therm::IThermalManager	773
4.33.1.5	class telux::therm::ITripPoint	776
4.33.1.6	class telux::therm::IThermalZone	778
4.33.1.7	class telux::therm::ICoolingDevice	780
4.33.2	Enumeration Type Documentation	781
4.33.2.1	AutoShutdownMode	781
4.33.2.2	TripType	781
4.33.2.3	TripEvent	782
4.33.2.4	ThermalNotificationType	782
4.33.3	Variable Documentation	782
4.33.3.1	DEFAULT_TIMEOUT	782
4.34	Thermal Shutdown Management	783
4.34.1	Data Structure Documentation	783
4.34.1.1	class telux::therm::IThermalShutdownListener	783
4.34.1.2	class telux::therm::IThermalShutdownManager	784
4.35	Power	787
4.36	TCU Activity Manager	788
4.36.1	Data Structure Documentation	788
4.36.1.1	class telux::power::PowerFactory	788
4.36.1.2	struct telux::power::ClientInstanceConfig	790
4.36.1.3	class telux::power::ITcuActivityListener	790
4.36.1.4	class telux::power::ITcuActivityManager	793
4.36.2	Enumeration Type Documentation	801
4.36.2.1	TcuActivityState	801
4.36.2.2	StateChangeResponse	801
4.36.2.3	ClientType	801
4.36.2.4	MachineEvent	802
4.36.2.5	TcuActivityStateAck	802
4.36.3	Variable Documentation	802
4.36.3.1	ALL_MACHINES	802
4.36.3.2	LOCAL_MACHINE	802
4.37	Modem Configuration	803
4.38	Modem Config	804
4.38.1	Data Structure Documentation	804
4.38.1.1	class telux::config::ConfigFactory	804
4.38.1.2	class telux::config::IConfigListener	805
4.38.1.3	class telux::config::IConfigManager	805
4.38.1.4	struct telux::config::ConfigInfo	808
4.38.1.5	class telux::config::IModemConfigListener	808
4.38.1.6	class telux::config::IModemConfigManager	809
4.38.2	Enumeration Type Documentation	814
4.38.2.1	ConfigType	814
4.38.2.2	AutoSelectionMode	814
4.38.2.3	ConfigUpdateStatus	814
4.39	Sensor	815
4.40	Sensor Service	816
4.40.1	Data Structure Documentation	816
4.40.1.1	struct telux::sensor::SensorInfo	816
4.40.1.2	struct telux::sensor::SensorConfiguration	817
4.40.1.3	struct telux::sensor::MotionSensorData	819

4.40.1.4	struct telux::sensor::UncalibratedMotionSensorData	819
4.40.1.5	struct telux::sensor::SensorEvent	819
4.40.1.6	struct telux::sensor::SensorFeature	819
4.40.1.7	struct telux::sensor::SensorFeatureEvent	820
4.40.1.8	class telux::sensor::SensorFactory	820
4.40.1.9	union telux::sensor::SensorEvent.__unnamed__	821
4.40.2	Enumeration Type Documentation	821
4.40.2.1	SensorType	821
4.40.2.2	SensorConfigParams	822
4.40.2.3	SelfTestType	822
4.41	Sensor Control	823
4.41.1	Data Structure Documentation	823
4.41.1.1	class telux::sensor::ISensorEventListener	823
4.41.1.2	class telux::sensor::ISensorClient	824
4.41.1.3	class telux::sensor::ISensorManager	828
4.42	Sensor Feature Control	831
4.42.1	Data Structure Documentation	831
4.42.1.1	class telux::sensor::ISensorFeatureEventListener	831
4.42.1.2	class telux::sensor::ISensorFeatureManager	832
4.43	Platform	835
4.43.1	Data Structure Documentation	835
4.43.1.1	class telux::platform::PlatformFactory	835
4.44	Filesystem	838
4.44.1	Data Structure Documentation	838
4.44.1.1	struct telux::platform::EfsEventInfo	838
4.44.1.2	class telux::platform::IFsListener	838
4.44.1.3	class telux::platform::IFsManager	839
4.44.2	Enumeration Type Documentation	843
4.44.2.1	EfsEvent	843
4.44.2.2	OperationStatus	843
4.44.2.3	OtaOperation	843
4.45	DeviceInfo	844
4.45.1	Data Structure Documentation	844
4.45.1.1	class telux::platform::IDeviceInfoListener	844
4.45.1.2	struct telux::platform::PlatformVersion	844
4.45.1.3	class telux::platform::IDeviceInfoManager	844
4.46	Hardware Antenna	847
4.46.1	Data Structure Documentation	847
4.46.1.1	class telux::platform::hardware::IAntennaListener	847
4.46.1.2	class telux::platform::hardware::IAntennaManager	847
4.47	Time	851
4.47.1	Data Structure Documentation	851
4.47.1.1	class telux::platform::ITimeListener	851
4.47.1.2	class telux::platform::ITimeManager	852
4.47.2	Enumeration Type Documentation	853
4.47.2.1	SupportedTimeType	853
4.48	Security Management	854
4.48.1	Data Structure Documentation	854
4.48.1.1	struct telux::sec::LoadConfig	854
4.48.1.2	struct telux::sec::CACapacity	854

4.48.1.3	struct telux::sec::CALoad	854
4.48.1.4	class telux::sec::ICAControlManagerListener	855
4.48.1.5	class telux::sec::ICAControlManager	856
4.48.1.6	struct telux::sec::EnvironmentInfo	858
4.48.1.7	struct telux::sec::CellularSecurityReport	858
4.48.1.8	struct telux::sec::SessionStats	859
4.48.1.9	class telux::sec::ICellularScanReportListener	860
4.48.1.10	class telux::sec::ICellularSecurityManager	861
4.48.1.11	class telux::sec::ConnectionSecurityFactory	863
4.48.1.12	struct telux::sec::ECCPoint	864
4.48.1.13	struct telux::sec::DataDigest	864
4.48.1.14	struct telux::sec::Signature	864
4.48.1.15	struct telux::sec::Scalar	865
4.48.1.16	struct telux::sec::OperationResult	865
4.48.1.17	class telux::sec::ICryptoAcceleratorListener	865
4.48.1.18	class telux::sec::ICryptoAcceleratorManager	867
4.48.1.19	class telux::sec::ResultParser	870
4.48.1.20	class telux::sec::ICryptoParam	872
4.48.1.21	struct telux::sec::EncryptedData	873
4.48.1.22	class telux::sec::ICryptoManager	873
4.48.1.23	class telux::sec::CryptoParamBuilder	878
4.48.1.24	class telux::sec::SecurityFactory	881
4.48.1.25	struct telux::sec::MLAlgorithmAnalysis	883
4.48.1.26	struct telux::sec::SummoningAnalysis	883
4.48.1.27	struct telux::sec::WiFiSecurityReport	883
4.48.1.28	struct telux::sec::DeauthenticationInfo	884
4.48.1.29	struct telux::sec::ApInfo	884
4.48.1.30	class telux::sec::IWiFiReportListener	884
4.48.1.31	class telux::sec::IWiFiSecurityManager	886
4.48.2	Enumeration Type Documentation	888
4.48.2.1	CellularThreatType	888
4.48.2.2	EnvironmentState	889
4.48.2.3	ActionType	889
4.48.2.4	RATType	890
4.48.2.5	Mode	890
4.48.2.6	RequestPriority	890
4.48.2.7	ECCCurve	891
4.48.2.8	OperationType	891
4.48.2.9	CryptoOperation	891
4.48.2.10	BlockMode	891
4.48.2.11	Padding	891
4.48.2.12	Digest	892
4.48.2.13	Algorithm	892
4.48.2.14	Curve	892
4.48.2.15	KeyFormat	892
4.48.2.16	AnalysisResult	893
4.48.3	Variable Documentation	893
4.48.3.1	CA_RESULT_DATA_LENGTH	893
4.49	Wlan	894
4.50	WLAN Device Management	895

4.50.1	Data Structure Documentation	895
4.50.1.1	struct telux::wlan::ApInfo	895
4.50.1.2	struct telux::wlan::ApNetInfo	895
4.50.1.3	struct telux::wlan::ApStatus	895
4.50.1.4	struct telux::wlan::StaStatus	895
4.50.1.5	struct telux::wlan::InterfaceStatus	896
4.50.1.6	struct telux::wlan::RegulatoryParams	896
4.50.1.7	class telux::wlan::IWlanDeviceManager	896
4.50.1.8	class telux::wlan::IWlanListener	897
4.50.1.9	class telux::wlan::WlanFactory	897
4.50.2	Enumeration Type Documentation	899
4.50.2.1	BandType	899
4.50.2.2	ConnectionStatus	899
4.50.2.3	Id	899
4.50.2.4	ApType	899
4.50.2.5	StaInterfaceStatus	900
4.50.2.6	OperationType	900
4.50.2.7	IpFamilyType	900
4.50.2.8	ServiceOperation	900
4.50.2.9	InterfaceState	901
4.50.2.10	HwDeviceType	901
4.50.2.11	DevicePerfState	901
4.50.3	Function Documentation	901
4.50.3.1	getServiceStatus()=0	901
4.50.3.2	enable(bool enable)=0	902
4.50.3.3	setMode(int numOfAp, int numOfSta)=0	902
4.50.3.4	getConfig(int &numAp, int &numSta)=0	903
4.50.3.5	getStatus(bool &isEnabled, std::vector< InterfaceStatus > &status)=0	903
4.50.3.6	setActiveCountry(std::string country)=0	904
4.50.3.7	getRegulatoryParams(RegulatoryParams &regulatoryParams)=0	904
4.50.3.8	setTxPower(uint32_t txPowerMw)=0	904
4.50.3.9	getTxPower(uint32_t &txPowerMw)=0	905
4.50.3.10	registerListener(std::weak_ptr< IWlanListener > listener)=0	905
4.50.3.11	deregisterListener(std::weak_ptr< IWlanListener > listener)=0	906
4.50.3.12	~IWlanDeviceManager()	906
4.50.3.13	onServiceStatusChange(telux::common::ServiceStatus status)	906
4.50.3.14	onTempCrossed(float temperature, DevicePerfState perfState)	906
4.50.3.15	onEnableChanged(bool enable)	906
4.50.3.16	~IWlanListener()	907
4.50.4	Variable Documentation	907
4.50.4.1	device	907
4.50.4.2	apStatus	907
4.50.4.3	staStatus	907
4.50.4.4	country	907
4.50.4.5	opChannel	907
4.50.4.6	opClass	907
4.50.4.7	txPowerMw	907
4.51	Access Point Management	908
4.51.1	Define Documentation	908
4.51.1.1	INVALID_AP_ID	908

4.51.2	Data Structure Documentation	908
4.51.2.1	struct telux::wlan::ApVenueInfo	908
4.51.2.2	struct telux::wlan::ApSecurity	908
4.51.2.3	struct telux::wlan::ApElementInfoConfig	908
4.51.2.4	struct telux::wlan::ApNetConfig	909
4.51.2.5	struct telux::wlan::ApConfig	909
4.51.2.6	struct telux::wlan::DeviceIndInfo	909
4.51.2.7	struct telux::wlan::DeviceInfo	910
4.51.2.8	class telux::wlan::IApInterfaceManager	910
4.51.2.9	class telux::wlan::IApListener	910
4.51.3	Enumeration Type Documentation	911
4.51.3.1	ApInterworking	911
4.51.3.2	ApDeviceConnectionEvent	911
4.51.3.3	SecMode	911
4.51.3.4	SecAuth	911
4.51.3.5	SecEncrypt	912
4.51.3.6	NetAccessType	912
4.51.4	Function Documentation	912
4.51.4.1	setConfig(ApConfig config)=0	912
4.51.4.2	setSecurityConfig(Id apId, ApSecurity apSecurity)=0	913
4.51.4.3	setSsid(Id apId, std::string ssid)=0	913
4.51.4.4	setVisibility(Id apId, bool isVisible)=0	913
4.51.4.5	setElementInfoConfig(Id apId, ApElementInfoConfig config)=0	914
4.51.4.6	setPassPhrase(Id apId, std::string passPhrase)=0	914
4.51.4.7	getConfig(std::vector< ApConfig > &config)=0	915
4.51.4.8	getStatus(std::vector< ApStatus > &status)=0	915
4.51.4.9	getConnectedDevices(std::vector< DeviceInfo > &clientsInfo)=0	915
4.51.4.10	manageApService(Id apId, ServiceOperation opr)=0	916
4.51.4.11	registerListener(std::weak_ptr< IApListener > listener)=0	917
4.51.4.12	deregisterListener(std::weak_ptr< IApListener > listener)=0	917
4.51.4.13	~IApInterfaceManager()	917
4.51.4.14	onApDeviceStatusChanged(ApDeviceConnectionEvent event, std::vector< DeviceIndInfo > info)	917
4.51.4.15	onApBandChanged(BandType radio)	918
4.51.4.16	onApConfigChanged(Id apId)	918
4.51.4.17	~IApListener()	918
4.51.5	Variable Documentation	918
4.51.5.1	type	918
4.51.5.2	group	918
4.51.5.3	mode	918
4.51.5.4	auth	918
4.51.5.5	encrypt	918
4.51.5.6	isEnabled	918
4.51.5.7	isInterworkingEnabled	918
4.51.5.8	netAccessType	919
4.51.5.9	internet	919
4.51.5.10	asra	919
4.51.5.11	esr	919
4.51.5.12	uesa	919
4.51.5.13	venueGroup	919

4.51.5.14	venueType	919
4.51.5.15	hessid	919
4.51.5.16	vendorElements	919
4.51.5.17	assocRespElements	919
4.51.5.18	info	919
4.51.5.19	ssid	919
4.51.5.20	isVisible	920
4.51.5.21	elementInfoConfig	920
4.51.5.22	interworking	920
4.51.5.23	apSecurity	920
4.51.5.24	passPhrase	920
4.51.5.25	id	920
4.51.5.26	venue	920
4.51.5.27	network	920
4.51.5.28	id	920
4.51.5.29	macAddress	920
4.51.5.30	id	920
4.51.5.31	name	920
4.51.5.32	ipv4Address	921
4.51.5.33	ipv6Address	921
4.51.5.34	macAddress	921
4.52	Station Management	922
4.52.1	Data Structure Documentation	922
4.52.1.1	struct telux::wlan::StaStaticIpConfig	922
4.52.1.2	struct telux::wlan::StaConfig	922
4.52.1.3	class telux::wlan::IStaInterfaceManager	922
4.52.1.4	class telux::wlan::IStaListener	923
4.52.2	Enumeration Type Documentation	923
4.52.2.1	StaIpConfig	923
4.52.2.2	StaBridgeMode	923
4.52.3	Function Documentation	923
4.52.3.1	setIpConfig(Id stald, StaIpConfig ipConfig, StaStaticIpConfig staticIpConfig)=0	923
4.52.3.2	setBridgeMode(Id stald, StaBridgeMode bridgeMode)=0	924
4.52.3.3	enableHotspot2(Id stald, bool enable)=0	924
4.52.3.4	getConfig(std::vector< StaConfig > &config)=0	925
4.52.3.5	getStatus(std::vector< StaStatus > &status)=0	925
4.52.3.6	manageStaService(Id stald, ServiceOperation opr)=0	926
4.52.3.7	registerListener(std::weak_ptr< IStaListener > listener)=0	926
4.52.3.8	deregisterListener(std::weak_ptr< IStaListener > listener)=0	926
4.52.3.9	~IStaInterfaceManager()	927
4.52.3.10	onStationStatusChanged(std::vector< StaStatus > staStatus)	927
4.52.3.11	onStationBandChanged(BandType radio)	927
4.52.3.12	~IStaListener()	927
4.52.4	Variable Documentation	927
4.52.4.1	ipAddr	927
4.52.4.2	gwIpAddr	927
4.52.4.3	netMask	927
4.52.4.4	dnsAddr	928
4.52.4.5	stald	928
4.52.4.6	ipConfig	928



4.52.4.7	staticIpConfig	928
4.52.4.8	bridgeMode	928
4.53	Diagnostics Services	929
4.53.1	Data Structure Documentation	929
4.53.1.1	struct telux::platform::diag::DiagStatus	929
4.53.1.2	union telux::platform::diag::SourceInfo	929
4.53.1.3	struct telux::platform::diag::FileMethodConfig	929
4.53.1.4	struct telux::platform::diag::DiagConfig	930
4.53.1.5	class telux::platform::diag::IDiagLogManager	930
4.53.1.6	class telux::platform::diag::IDiagListener	934
4.53.1.7	class telux::platform::diag::DiagnosticsFactory	935
4.53.2	Enumeration Type Documentation	936
4.53.2.1	DiagLogMode	936
4.53.2.2	DeviceType	936
4.53.2.3	PeripheralType	937
4.53.2.4	LogMethod	937
4.53.2.5	SourceType	937
4.54	Cellular Data	938
4.54.1	Define Documentation	938
4.54.1.1	PROFILE_ID_MAX	938
4.54.1.2	MAX_QOS_FILTERS	938
4.54.1.3	IP_PROT_UNKNOWN	938
4.54.2	Data Structure Documentation	938
4.54.2.1	struct telux::data::DataUsage	938
4.54.2.2	struct telux::data::DeviceDataUsage	938
4.54.2.3	class telux::data::IClientManager	938
4.54.2.4	class telux::data::IClientListener	941
4.54.2.5	struct telux::data::IpFamilyInfo	942
4.54.2.6	struct telux::data::QosFilterRule	942
4.54.2.7	struct telux::data::TrafficFlowTemplate	942
4.54.2.8	struct telux::data::TftChangeInfo	943
4.54.2.9	struct telux::data::BitRateInfo	943
4.54.2.10	class telux::data::IDataConnectionManager	943
4.54.2.11	class telux::data::IDataCall	949
4.54.2.12	class telux::data::IDataConnectionListener	954
4.54.2.13	struct telux::data::DataRestrictMode	955
4.54.2.14	struct telux::data::PortInfo	956
4.54.2.15	struct telux::data::ProfileParams	956
4.54.2.16	struct telux::data::DataCallStats	956
4.54.2.17	struct telux::data::IpAddrInfo	957
4.54.2.18	struct telux::data::DataCallEndReason	957
4.54.2.19	struct telux::data::BackhaulInfo	957
4.54.2.20	struct telux::data::VlanConfig	957
4.54.2.21	struct telux::data::FlowDataRate	958
4.54.2.22	struct telux::data::QosIPFlowInfo	958
4.54.2.23	class telux::data::DataFactory	958
4.54.2.24	class telux::data::IDataFilterListener	964
4.54.2.25	class telux::data::IDataFilterManager	965
4.54.2.26	struct telux::data::EthCapability	971
4.54.2.27	class telux::data::IDataLinkManager	972

4.54.2.28	class telux::data::IDataLinkListener	975
4.54.2.29	class telux::data::DataProfile	977
4.54.2.30	class telux::data::IDataProfileListener	979
4.54.2.31	class telux::data::IDataProfileManager	980
4.54.2.32	class telux::data::IDataCreateProfileCallback	985
4.54.2.33	class telux::data::IDataProfileListCallback	985
4.54.2.34	class telux::data::IDataProfileCallback	986
4.54.2.35	struct telux::data::DdsInfo	986
4.54.2.36	struct telux::data::BandInterferenceConfig	987
4.54.2.37	class telux::data::IDataSettingsManager	987
4.54.2.38	class telux::data::IDataSettingsListener	995
4.54.2.39	struct telux::data::IPv4Info	996
4.54.2.40	struct telux::data::IPv6Info	997
4.54.2.41	struct telux::data::UdpInfo	997
4.54.2.42	struct telux::data::TcpInfo	997
4.54.2.43	struct telux::data::IcmpInfo	998
4.54.2.44	struct telux::data::EspInfo	998
4.54.2.45	class telux::data::IipFilter	998
4.54.2.46	class telux::data::IudpFilter	1000
4.54.2.47	class telux::data::ITcpFilter	1001
4.54.2.48	class telux::data::IicmpFilter	1001
4.54.2.49	class telux::data::IEspFilter	1002
4.54.2.50	struct telux::data::RoamingStatus	1003
4.54.2.51	struct telux::data::ServiceStatus	1003
4.54.2.52	class telux::data::IServingSystemManager	1003
4.54.2.53	class telux::data::IServingSystemListener	1007
4.54.2.54	union telux::data::DataCallEndReason, __unnamed__	1009
4.54.3	Enumeration Type Documentation	1009
4.54.3.1	UsageResetReason	1009
4.54.3.2	IpfamilyType	1009
4.54.3.3	TechPreference	1010
4.54.3.4	AuthProtocolType	1010
4.54.3.5	DataRestrictModeType	1010
4.54.3.6	ApnMaskType	1010
4.54.3.7	DataCallStatus	1011
4.54.3.8	DataBearerTechnology	1011
4.54.3.9	EndReasonType	1011
4.54.3.10	MobileIpReasonCode	1012
4.54.3.11	InternalReasonCode	1013
4.54.3.12	CallManagerReasonCode	1014
4.54.3.13	SpecReasonCode	1017
4.54.3.14	PPPReasonCode	1019
4.54.3.15	EHRPDReasonCode	1019
4.54.3.16	Ipv6ReasonCode	1019
4.54.3.17	HandoffReasonCode	1020
4.54.3.18	ProfileChangeEvent	1020
4.54.3.19	OperationType	1020
4.54.3.20	Direction	1020
4.54.3.21	InterfaceType	1020
4.54.3.22	BackhaulType	1021

4.54.3.23	ServiceState	.1021
4.54.3.24	QosFlowStateChangeEvent	.1021
4.54.3.25	IpTrafficClassType	.1021
4.54.3.26	QosIPFlowMaskType	.1022
4.54.3.27	QosFlowMaskType	.1022
4.54.3.28	EthModeType	.1022
4.54.3.29	LinkModeChangeStatus	.1022
4.54.3.30	BandPriority	.1023
4.54.3.31	DdsType	.1023
4.54.3.32	DrbStatus	.1023
4.54.3.33	RoamingType	.1023
4.54.3.34	DataServiceState	.1023
4.54.3.35	NetworkRat	.1024
4.54.3.36	NrlconType	.1024
4.55	net	.1025
4.55.1	Data Structure Documentation	.1025
4.55.1.1	struct telux::data::net::BridgeInfo	.1025
4.55.1.2	class telux::data::net::IBridgeManager	.1025
4.55.1.3	class telux::data::net::IBridgeListener	.1028
4.55.1.4	struct telux::data::net::FirewallConfig	.1029
4.55.1.5	struct telux::data::net::DmzConfig	.1029
4.55.1.6	struct telux::data::net::FirewallEntryInfo	.1029
4.55.1.7	class telux::data::net::IFirewallManager	.1030
4.55.1.8	class telux::data::net::IFirewallEntry	.1042
4.55.1.9	class telux::data::net::IFirewallListener	.1043
4.55.1.10	struct telux::data::net::L2tpSessionConfig	.1044
4.55.1.11	struct telux::data::net::L2tpTunnelConfig	.1044
4.55.1.12	struct telux::data::net::L2tpSysConfig	.1045
4.55.1.13	class telux::data::net::IL2tpManager	.1045
4.55.1.14	class telux::data::net::IL2tpListener	.1049
4.55.1.15	struct telux::data::net::NatConfig	.1049
4.55.1.16	class telux::data::net::INatManager	.1049
4.55.1.17	class telux::data::net::INatListener	.1053
4.55.1.18	class telux::data::net::ISocksManager	.1054
4.55.1.19	class telux::data::net::ISocksListener	.1056
4.55.1.20	struct telux::data::net::VlanBindConfig	.1057
4.55.1.21	class telux::data::net::IVlanManager	.1057
4.55.1.22	class telux::data::net::IVlanListener	.1064
4.55.2	Enumeration Type Documentation	.1065
4.55.2.1	BridgeFaceType	.1065
4.55.2.2	L2tpProtocol	.1065
4.56	Cellular V2X	.1066
<b>5</b>	<b>Namespace Documentation</b>	<b>.1067</b>
5.1	telux Namespace Reference	.1067
5.2	telux::audio Namespace Reference	.1067
5.2.1	Variable Documentation	.1068
5.2.1.1	INFINITE_DTMF_DURATION	.1068
5.2.1.2	INFINITE_TONE_DURATION	.1068
5.3	telux::common Namespace Reference	.1068

5.3.1	Typedef Documentation	.1069
5.3.1.1	ResponseCallback	.1069
5.3.1.2	InitResponseCb	.1069
5.4	telux::config Namespace Reference	.1069
5.5	telux::cv2x Namespace Reference	.1070
5.5.1	Typedef Documentation	.1071
5.5.1.1	CreateRxSubscriptionCallback	.1072
5.5.1.2	CreateTxSpsFlowCallback	.1072
5.5.1.3	CreateTxEventFlowCallback	.1072
5.5.1.4	CloseTxFlowCallback	.1073
5.5.1.5	CloseRxSubscriptionCallback	.1073
5.5.1.6	ChangeSpsFlowInfoCallback	.1073
5.5.1.7	RequestSpsFlowInfoCallback	.1073
5.5.1.8	ChangeEventFlowInfoCallback	.1074
5.5.1.9	RequestCapabilitiesCallback	.1074
5.5.1.10	RequestDataSessionSettingsCallback	.1074
5.5.1.11	UpdateTrustedUEListCallback	.1075
5.5.1.12	UpdateSrcL2InfoCallback	.1075
5.5.1.13	CreateTcpSocketCallback	.1075
5.5.1.14	CloseTcpSocketCallback	.1075
5.5.1.15	StartCv2xCallback	.1076
5.5.1.16	StopCv2xCallback	.1076
5.5.1.17	RequestCv2xStatusCallback	.1076
5.5.1.18	RequestCv2xStatusCallbackEx	.1077
5.5.1.19	UpdateConfigurationCallback	.1077
5.5.1.20	GetSlssRxInfoCallback	.1077
5.6	telux::cv2x::prop Namespace Reference	.1077
5.7	telux::data Namespace Reference	.1078
5.8	telux::data::net Namespace Reference	.1081
5.9	telux::loc Namespace Reference	.1082
5.10	telux::platform Namespace Reference	.1084
5.11	telux::platform::diag Namespace Reference	.1085
5.12	telux::platform::hardware Namespace Reference	.1086
5.13	telux::power Namespace Reference	.1086
5.14	telux::sec Namespace Reference	.1086
5.15	telux::sensor Namespace Reference	.1087
5.16	telux::tel Namespace Reference	.1089
5.16.1	Data Structure Documentation	.1095
5.16.1.1	struct telux::tel::ImsRegistrationInfo	.1095
5.16.1.2	struct telux::tel::ImsServiceInfo	.1095
5.16.2	Typedef Documentation	.1095
5.16.2.1	ImsRegistrationInfoCb	.1095
5.16.2.2	ImsServiceInfoCb	.1096
5.16.2.3	RatMask	.1096
5.16.2.4	SelectionModeResponseCallback	.1096
5.16.2.5	PreferredNetworksCallback	.1096
5.16.2.6	NetworkScanCallback	.1097
5.16.3	Enumeration Type Documentation	.1097
5.16.3.1	RegistrationStatus	.1097
5.16.3.2	CellularServiceStatus	.1097

5.17	telux::therm Namespace Reference	.1097
5.18	telux::wlan Namespace Reference	.1098
<b>6</b>	<b>Data Structure Documentation</b>	<b>.1100</b>
6.1	telux::cv2x::ICv2xListener Class Reference	.1100
6.1.1	Constructors and Destructors	.1100
6.1.1.1	~ICv2xListener()	.1100
6.1.2	Member Function Documentation	.1100
6.1.2.1	onStatusChanged(Cv2xStatus status)	.1100
6.1.2.2	onStatusChanged(Cv2xStatusEx status)	.1101
6.1.2.3	onSlssRxInfoChanged(const SlssRxInfo &slssInfo)	.1101
6.2	telux::tel::IImServingSystemListener Class Reference	.1101
6.2.1	Constructors and Destructors	.1101
6.2.1.1	~IImServingSystemListener()	.1102
6.2.2	Member Function Documentation	.1102
6.2.2.1	onServiceStatusChange(telux::common::ServiceStatus status)	.1102
6.2.2.2	onImSRegStatusChange(ImSRegistrationInfo status)	.1102
6.2.2.3	onImServiceInfoChange(ImServiceInfo service)	.1102
6.3	telux::tel::IImServingSystemManager Class Reference	.1102
6.3.1	Constructors and Destructors	.1103
6.3.1.1	~IImServingSystemManager()	.1103
6.3.2	Member Function Documentation	.1103
6.3.2.1	getServiceStatus()=0	.1103
6.3.2.2	requestRegistrationInfo(ImSRegistrationInfoCb callback)=0	.1103
6.3.2.3	requestServiceInfo(ImServiceInfoCb callback)=0	.1103
6.3.2.4	registerListener(std::weak_ptr< telux::tel::IImServingSystemListener > listener)=0	.1104
6.3.2.5	deregisterListener(std::weak_ptr< telux::tel::IImServingSystemListener > listener)=0	.1104
6.4	telux::common::IServiceStatusListener Class Reference	.1104
6.4.1	Constructors and Destructors	.1105
6.4.1.1	~IServiceStatusListener()	.1105
6.4.2	Member Function Documentation	.1105
6.4.2.1	onServiceStatusChange(ServiceStatus status)	.1105

## List of Figures

2-1	SDK-Overview	8
2-2	Remote SIM Provisioning	19
2-3	Data SSR and Recovery	21
3-1	Phone manager initialization	25
3-2	Dial call flow	26
3-3	ECall call flow	28
3-4	ECall call flow	30
3-5	Answer, Reject, RejectWithSMS call flow	32
3-6	Hold call flow	33
3-7	Hold, Conference, Swap call flow	34
3-8	SMS call flow	36
3-9	Signal strength call flow	37
3-10	CellBroadcast call flow	38
3-11	Radio and Service state call flow	39
3-12	Network selection manager call flow	41
3-13	Serving System Manager Call Flow	43
3-14	Card-Get applications call flow	45
3-15	On logical channel	46
3-16	On basic channel	47
3-17	Request card reader status, Request ATR, Transmit APDU call flow	48
3-18	SIM Turn off, Turn on and Reset call flow	50
3-19	Subscription initialization call flow	51
3-20	Subscription call flow	52
3-21	Download and deletion of profile call flow	53
3-22	SIM profile management operations call flow	55
3-23	HttpTransaction subsystem readiness and handling of indication from modem call flow	57
3-24	Remote SIM call flow	59
3-25	Call flow to register/remove listener for generating basic reports	61
3-26	Call flow to register/remove listener for generating detailed reports	62
3-27	Call flow to register/remove listener for generating detailed engine reports	64
3-28	Call flow to register/remove listener for system info updates	65
3-29	Call flow to request energy consumed information	66
3-30	Call flow to get year of hardware information	67
3-31	Call flow to get terrestrial positioning information	67
3-32	Call flow to cancel terrestrial positioning information	68
3-33	Call flow to enable/disable constraint time uncertainty	68
3-34	Call flow to enable/disable PACE	69
3-35	Call flow to delete all aiding data	69
3-36	Call flow to configure lever arm parameters	70
3-37	Call flow to configure blacklisted constellations	70
3-38	Call flow to configure robust location	71
3-39	Call flow to configure min gps week	71
3-40	Call flow to request min gps week	72
3-41	Call flow to delete specified data	72
3-42	Call flow to configure min sv elevation	73
3-43	Call flow to request min sv elevation	73

3-44 Call flow to request robust location . . . . .	74
3-45 Call flow to configure dead reckoning engine . . . . .	74
3-46 Call flow to configure secondary band . . . . .	75
3-47 Call flow to request secondary band . . . . .	75
3-48 Call flow to configure engine state . . . . .	76
3-49 Call flow to provide user consent for terrestrial positioning . . . . .	76
3-50 Call flow to configure NMEA sentence type . . . . .	77
3-51 Call flow to represent Xtra Feature . . . . .	78
3-52 Call flow to inject RTCM correction data with dgncs manager . . . . .	79
3-53 Start/Stop data call call flow . . . . .	80
3-54 Request data profile list call flow . . . . .	82
3-55 Get Dedicated Radio Bearer Call Flow . . . . .	83
3-56 Request service status call flow . . . . .	84
3-57 Request roaming status call flow . . . . .	85
3-58 Get/Set data filter mode call flow . . . . .	86
3-59 Add data restrict filter call flow . . . . .	87
3-60 Remove data restrict filter call flow . . . . .	88
3-61 Create VLAN and bind it to PDN for data VLAN manager call flow . . . . .	90
3-62 LAN-LAN VLAN Configuration Usecase from EAP call flow . . . . .	91
3-63 LAN-LAN VLAN Configuration Usecase from A7 call flow . . . . .	93
3-64 LAN-WAN VLAN Configuration Usecase from EAP call flow . . . . .	94
3-65 LAN-WAN VLAN Configuration Usecase from A7 call flow . . . . .	97
3-66 Create Static NAT entry for data NAT manager call flow . . . . .	99
3-67 Firewall enablement in data Firewall manager call flow . . . . .	100
3-68 Add Firewall entry in data Firewall manager call flow . . . . .	101
3-69 Set Firewall DMZ in data Firewall manager call flow . . . . .	102
3-70 Socks enablement in data Socks manager call flow . . . . .	103
3-71 L2TP enablement and Configuration in data L2TP manager call flow . . . . .	105
3-72 Call flow to add and enable a software bridge . . . . .	107
3-73 Call flow to remove and disable a software bridge . . . . .	108
3-74 Retrieve/Update C-V2X Configuration Call Flow - C++ version . . . . .	110
3-75 Retrieve/Update C-V2X Configuration Call Flow - C Version . . . . .	112
3-76 Start/Stop C-V2X Mode Call Flow - C++ Version . . . . .	113
3-77 Start/Stop C-V2X Mode Call Flow - C Version . . . . .	114
3-78 C-V2X Radio Control Flow - C++ Version . . . . .	115
3-79 C-V2X Radio Control Flow - C Version . . . . .	116
3-80 C-V2X Radio Initialization Call Flow - C++ Version . . . . .	118
3-81 C-V2X Radio Initialization Call Flow - C Version . . . . .	119
3-82 Get C-V2X Status Call Flow - C++ Version . . . . .	120
3-83 Get C-V2X Status Call Flow - C Version . . . . .	121
3-84 Get C-V2X Capabilities Call Flow - C++ Version . . . . .	122
3-85 Get C-V2X Capabilities Call Flow - C Version . . . . .	123
3-86 C-V2X Radio RX Subscription Call Flow - C++ Version . . . . .	124
3-87 C-V2X Radio RX Subscription Call Flow - C Version . . . . .	126
3-88 C-V2X Radio TX Event Flow Call Flow - C++ Version . . . . .	127
3-89 C-V2X Radio TX Event Flow Call Flow - C++ Version . . . . .	128
3-90 C-V2X Radio SPS Flow Call Flow - C++ Version . . . . .	129
3-91 C-V2X Radio SPS Flow Call Flow - C Version . . . . .	130
3-92 C-V2X Throttle Manager Filter Rate Adjustment Notification call flow . . . . .	131
3-93 C-V2X Throttle Manager set verification call flow . . . . .	131

3-94 C-V2X TX Status Report Call Flow - C++ Version . . . . .	132
3-95 C-V2X TX Status Report Call Flow - C Version . . . . .	133
3-96 C-V2X RX Meta Data Call Flow - C++ Version . . . . .	134
3-97 C-V2X RX Meta Data Call Flow - C Version . . . . .	136
3-98 Audio Manager API call flow . . . . .	137
3-99 Audio Voice Call Start/Stop call flow . . . . .	139
3-100 Audio Voice Call Device Switch call flow . . . . .	141
3-101 Audio Voice Call Volume/Mute control call flow . . . . .	143
3-102 Call flow to play DTMF tone . . . . .	145
3-103 Call flow to detect DTMF tone . . . . .	147
3-104 Audio Playback call flow . . . . .	149
3-105 Audio Capture call flow . . . . .	151
3-106 Call flow to play/stop tone on a sink device . . . . .	153
3-107 Call flow to start/stop loopback between source and sink devices . . . . .	154
3-108 Call flow to play Compressed audio format . . . . .	156
3-109 Audio Transcoding Operation Callflow . . . . .	158
3-110 Compressed audio format playback on Voice Paths Callflow . . . . .	160
3-111 Audio Subsystem Restart Callflow . . . . .	162
3-112 Audio calibration configuration status . . . . .	163
3-113 Thermal manager API call flow . . . . .	164
3-114 Call flow to register/remove listener for Thermal manager notifications . . . . .	166
3-115 Call flow to register/remove listener for Thermal shutdown manager . . . . .	168
3-116 Call flow to set/get the Thermal auto-shutdown mode . . . . .	169
3-117 Call flow to manage thermal auto-shutdown from an eCall application . . . . .	171
3-118 Call flow to register/remove listener for TCU-activity manager . . . . .	174
3-119 Call flow to set the TCU-activity state . . . . .	176
3-120 Modem Config load and activate call flow . . . . .	178
3-121 Modem Config deactivate and delete Call Flow . . . . .	179
3-122 Modem Config get and set Auto Selection Mode Call Flow . . . . .	181
3-123 Sensor sub-system start-up call flow . . . . .	182
3-124 Sensor data acquisition call flow . . . . .	184
3-125 Sensor reconfiguration call flow . . . . .	185
3-126 Sensor sub-system cleanup call flow . . . . .	186
3-127 Sensor power control cleanup call flow . . . . .	187
3-128 Sensor feature control cleanup call flow . . . . .	188
3-129 EFS restore notification registration and handling call flow . . . . .	190
3-130 Control the filesystem for ECALL operation call flow . . . . .	192
3-131 Control the filesystem for OTA operation call flow . . . . .	193
3-132 Sensor self test call flow . . . . .	194
3-133 Call flow to generate and export key . . . . .	195
3-134 Call flow to sign and verify data . . . . .	196
3-135 Call flow to encrypt and decrypt data . . . . .	197
3-136 Call flow for signature verification synchronous mode . . . . .	198
3-137 Call flow for signature verification asynchronous poll mode . . . . .	198
3-138 Call flow for signature verification asynchronous listener mode . . . . .	199
3-139 Call flow for ECQV calculation synchronous mode . . . . .	200
3-140 Call flow for ECQV calculation asynchronous poll mode . . . . .	200
3-141 Call flow for ECQV calculation asynchronous listener mode . . . . .	201
3-142 Call flow to register listener and receive reports . . . . .	202
3-143 Call flow to register listener and receive reports . . . . .	203



3-144	Modify WLAN Configuration Call Flow . . . . .	204
3-145	Modify WLAN Station Configuration Call Flow . . . . .	206
3-146	Modify WLAN Access Point Configuration Call Flow . . . . .	207
3-147	Log Collection Using File Method Call Flow . . . . .	209
3-148	Log Collection Using Callback Method Call Flow . . . . .	211

# 1 Introduction

---

## 1.1 Purpose

The Telematics software development kit (TelSDK) is a set of application programming interfaces (APIs) that provide access to the QTI-specific hardware and software capabilities.

This document is intended to act as a reference guide for developers by providing details of the TelSDK APIs, function call flows and overview of TelSDK architecture.

## 1.2 Scope

This document focusses on providing details of the TelSDK APIs. It assumes that the developer is familiar with Linux and C++11 programming.

## 1.3 Conventions

Function declarations, function names, type declarations, and code samples appear in a different font. For example,

```
#include
```

Parameter directions are indicated as follows:

### Parameters

in	<i>paramname</i>	indicates an input parameter.
out	<i>paramname</i>	indicates an output parameter.
in, out	<i>paramname</i>	indicates a parameter used for both input and output.

Most APIs are asynchronous as underlying sub-systems such as telephony are asynchronous. API names follow the convention of using prefix " get " for synchronous calls and " request " for asynchronous calls. Asynchronous responses such as listener callbacks come on a different thread than the application thread.

## 1.4 SDK Versioning

The following convention is used for versioning the SDK releases

**SDK version (major.minor.patch)**

```
SDK_VERSION = 1.0.0
```

**Major version:** This number will be incremented whenever significant changes or features are introduced.

**Minor version:** This number will be incremented when smaller features with some new APIs are introduced.

**Patch version:** If the release only contains bug fixes, but no API change then the patch version would be incremented, No change in the actual API interface.

**NOTE:** Use `telux::common::Version::getSdkVersion()` API to query the current version of SDK or refer the VERSION file in the repository

## 1.5 Public API Status

Public APIs are introduced and removed (if necessary) in phases. This allows users of an existing API that is being Deprecated to migrate. APIs will be marked with note indicating whether the API is subject to change or if it is not recommended to use the API.

as follows:

- **Eval:** This is a new API and is being evaluated. It is subject to change and could break backwards compatibility.
- **Obsolete:** API is not preferred and a better alternative is available.
- **Deprecated:** API is not going to be supported in future releases. Clients should stop using this API. Once an API has been marked as Deprecated, the API could be removed in future releases.

## 2 Functional Overview

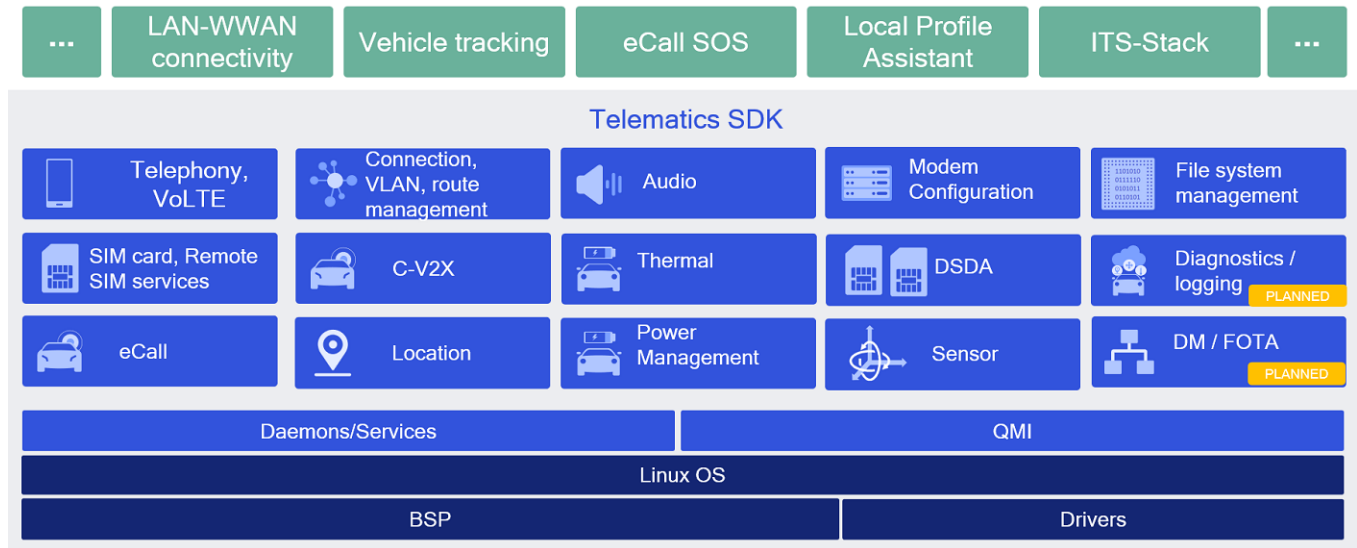

Figure 2-1 SDK-Overview

### 2.1 Overview

The Telematics library runs in the user space of the Linux system. It interacts with Telephony services and other sub-systems to provide various services like phone calls, SMS etc. These services are exposed by the SDK through fixed public APIs that are available on all Telematics platforms that support SDK. The Telematics APIs are grouped into the following functional modules:

#### Telephony

Telephony sub-system consists of APIs for functions related to Phone, Call, SMS and Signal Strength, Network Selection and Serving System Management.

#### SIM Card Services

SIM Card services sub-system consists of APIs to perform SIM card operations such as Send APDU messages to SIM card applications, SIM Access Profile(SAP) operations etc.

#### Location Services

Location Services sub-system consists of APIs to receive location details such as GNSS Positions, Satellite Vehicle information, Jammer Data signals, nmea and measurements information. The location manager sub-system also consists of APIs to get location system info, request energy consumed, get year of hardware information, get terrestrial position information and cancel terrestrial position information.

LocationConfigurator allows general engine configurations (example: TUNC, PACE etc), configuration of specific engines like SPE (example: minSVElevation, minGPSWeek etc) or DRE, deletion of warm and cold aiding data, NMEA configuration and support for XTRA feature.

### **Connection Management**

Connection Management sub-system consists of APIs for establishing Cellular WAN/ Backhaul connection sessions and for Connection Profile Management etc.

### **Audio Management**

Audio Management sub-system consists of APIs for Audio management such as setting up audio streams, switching devices on streams, apply volume/mute etc

### **Thermal Management**

Thermal Management sub-system consists of APIs to get list of thermal zones, cooling devices and binding information. The sub-system also provides notifications about certain thermal related events such as when trip event occur for any thermal zone or cooling device changes its level.

### **Thermal Shutdown Mangement**

Thermal shutdown management sub-system consists of APIs to get/set the thermal auto-shutdown mode and listen to its updates.

### **TCU Activity Management**

TCU Activity Management sub-system consists of APIs to get TCU-activity state updates, set the TCU-activity state, etc.

### **Remote SIM Services**

Remote SIM sub-system consists of APIs that allow a device that does not have a SIM physically connected to it to access a SIM remotely (e.g. over BT, Ethernet, etc.) and perform card operations on that SIM, such as requesting reset, transmitting APDU messages, etc.

### **Modem Config Services**

Modem Config sub-system consists of APIs that allow to request modem config files, load/delete a modem config file from modem's storage, activate/deactivate a modem config file, get/set auto selection mode for config files.

### **Data Network Management**

Data Network Management sub-system consists of APIs to setup VLAN, static NAT, Firewall, Socks, etc.

### **Sensor services**

The sensor sub-system provides API to configure and acquire data from underlying hardware sensors like accelerometers, gyroscopes among others.

### **Platform services**

The platform sub-system provides APIs to configure and control platform functionalities, like starting an EFS backup, control filesystem for ECALL and OTA operations. This sub-system also provides notifications about certain system related events, for instance filesystem events such as EFS restore and backup events.

### **Remote SIM Provisioning**

Remote SIM provisioning provides API to add profile, delete profile, activate/deactivate profile on the embedded SIMs (eUICC) , get list of profiles, get server address like SMDP+ and SMDS and update SMDP+ address, update nick name of profile and retrieve Embedded Identity Document(EID) of the SIM.

### **Debug Logger**

Logger consists of API that can be utilized to log messages from SDK Applications.

### **WLAN Management**

The WLAN management subsystem consists of APIs to configure, enable, and set access point and station configurations.

### **Diagnostics Services**

The Diagnostics services subsystem consists of APIs to configure, start and stop diagnostic logging.

Telematics SDK classes can be broadly divided into the following types:

- Factory - Factory classes are central classes such as PhoneFactory which can be used to create Manager classes corresponding to their sub-systems such as PhoneManager.
- Manager - Manager classes such as PhoneManager to manage multiple Phone instances, CardManager to manage multiple SIM Card instances etc.
- Observer/ Listener - Listener for unsolicited responses.
- Command Callback - Single-shot response callback for asynchronous API requests.
- Logger - APIs to log messages, control the log levels.

## **2.2 Features**

Telematics SDK provides APIs for the following features:

### **2.2.1 Call Management**

CallManager, Phone and PhoneManager APIs of Telematics SDK provides call related control operations such as

- Initiate a voice call
- Answer the incoming call
- Hold the call
- Hangup waiting, held or active call

CallManager and PhoneManager also provides additional functionality such as

- Allowing conference, and switch between waiting or holding call and active call
- Emergency Call (dial 112)
- Third Party Service (TPS) Emergency Call (dial custom number)
- Notifications about call state change

## 2.2.2 SMS

SMS Manager APIs of Telematics SDK provides SMS related functionality such as

- Sends and receives SMS messages of type GSM7, GSM8 and UCS2

## 2.2.3 SIM Card Services

The SIM Card operations are performed by CardManager and SapCardManager.

CardManager APIs of Telematics SDK perform operations on UICC card such as

- Open or close logical/basic channel to ICC card
- Transmit Application Protocol Data Unit (APDU) to the ICC Card over logical/basic channel
- Receive response APDU from the ICC Card with the status
- Notify about ICC card information change

SapCardManager APIs provides SIM Access Profile(SAP) related functionality such as

- Open or close SIM Access Profile(SAP) connection
- Transmit Application Protocol Data Unit (APDU) over SAP connection
- Receive response APDU over SAP connection
- Perform SAP operations such as Answer to Reset(ATR), SIM Power off, SIM Power On, SIM Reset and fetch Card Reader status.

## 2.2.4 Phone Information

Phone APIs of Telematics SDK provides phone related information such as

- Get Service state of phone i.e. EMERGENCY\_ONLY, IN\_SERVICE and OUT\_OF\_SERVICE
- Get Radio state of device i.e RADIO\_STATE\_OFF, RADIO\_STATE\_ON and RADIO\_STATE\_UNAVAILABLE
- Retrieve the signal strength corresponding to the technology supported by SIM
- Device Identity
- Set or Request Operating Mode
- Subscription Information

## 2.2.5 Location Services

Location Services APIs of Telematics SDK provide the mechanism to register listener and to receive location updates, satellite vehicle information, jammer signals, nmea and measurement updates. The location manager sub-system also consists of APIs to get location system info, request energy consumed, get year of hardware information, get terrestrial position information and cancel terrestrial position information. Following parameters are configurable through the APIs.

- Minimum time interval between two consecutive location reports.
- Minimum distance travelled after which the period between two consecutive location reports depends on the interval specified.

LocationConfigurator allows general engine configurations (example: TUNC, PACE etc), configuration of specific engines like SPE (example: minSVElevation, minGPSWeek etc) or DRE, deletion of warm and cold aiding data, NMEA configuration and support for XTRA feature.

## 2.2.6 Data Services

Data Services APIs in the Telematics SDK used for cellular connectivity, modem profile management, filters management, and networking.

Data Connection Manager APIs provide functionality such as

- start / stop data call
- listen for data call state changes

Data Profile Manager APIs provide functionality such as

- List available profiles in the modem
- Create / modify / delete / modify modem profiles
- Query for the selected profile

Data Serving System Manager APIs provide functionality such as

- Get dedicated radio bearer status
- Request Modem Service Status
- Request Modem Roaming Status

Data Filter Manager APIs provide functionality such as

- get / set data filter mode per data call
- get / set data filter mode for all data call in up state
- add / remove data filter per data call
- add / remove data filter for all data call in up state

Data VLAN Manager APIs provide functionality such as

- Create / remove VLAN
- Query VLAN info



- Bind / unbind VLAN to PDN
- Query current VLAN to PDN mapping

Data Static LAN Manager APIs provide functionality such as

- Add / remove static LAN entry
- Request current static NAT entries

Data Firewall Manager APIs provide functionality such as

- Add / remove DMZ entry
- Query current DMZ entries
- Set Firewall configuration to enable / disable Firewall
- Query current status of Firewall
- Add / remove Firewall entry
- Query Firewall entry rules

Data Socks Manager APIs provide functionality such as

- Enable/Disable Socks feature

Data L2TP Manager APIs provides functionality such as

- Set L2TP configuration to enable/disable L2TP, TCP Mss and MTU size
- Add / remove L2TP tunnel
- Query active L2TP configuration

Data Software Bridge Manager provides interface to enable packet acceleration for non-standard WLAN and Ethernet physical interfaces. It facilitates to configure a software bridge between the interface and Hardware accelerator. Its APIs provide functionality such as

- Add / remove a software bridge
- Query the software bridges configured in the system
- Enable / Disable the software bridge management

Data Serving System Manager provides the interface to access network and modem low level services. The API includes method for:

- Request Modem Service Status
- Request Modem Roaming Status
- Register to get notifications when Service Status and Roaming status Change Data client Manager APIs provide functionality such as
- fetch device data usage Configurations relevant to device data usage monitoring are available in data related configuration files - /etc/data/mobileap\_cfg.xml and /etc/data/ipa/IPACM\_cfg.xml

## 2.2.7 Network Selection and Serving System Management

Network Selection and Service System Management APIs in the Telematics SDK used for configuring the networks and preferences

Network Selection Manager APIs provide functionality such as

- request or set network selection mode (Manual or Automatic)
- scan for available networks
- request or set preferred networks list

Serving System Manager APIs provide functionality such as

- request and set service domain preference and radio access technology mode preference for searching and registering (CS/PS domain, RAT and operation mode)

## 2.2.8 C-V2X

The C-V2X sub-system contains APIs that support Cellular-V2X operation.

Cellular-V2X APIs in the Telematics SDK include Cv2xRadioManager and Cv2xRadio interfaces.

Cv2xRadioManager provides an interface to a C-V2X capable modem. The API includes methods for

- Enabling C-V2X mode
- Disabling C-V2X mode
- Querying the status of C-V2X
- Updating the C-V2X configuration via a config XML file

Cv2xRadio abstracts a C-V2X radio channel. The API includes methods for

- Obtaining the current capabilities of the radio
- Listen for radio state changes
- Creating and Closing an RX subscription
- Creating and Closing a TX event-driven flow
- Creating and Closing a TX semi-persistent-scheduling (SPS) flow
- Updating TX SPS flow parameters
- Update Source L2 Info

## 2.2.9 Audio

The Audio subSystem contains of APIs that support Audio operation.

Audio APIs in the Telematics SDK include AudioManager, AudioStream, AudioVoiceStream, AudioPlayStream, AudioCaptureStream, AudioLoopbackStream, AudioToneGenerator, Transcoder interfaces.

AudioManager provides an interface for creation/deletion of audio stream. The API includes methods for

- Query readiness of subSystem
- Query supported "Device Types"
- Query supported "Stream Types"
- Creating Audio Stream
- Deleting Audio Stream

AudioStream abstracts the properties common to different stream types. The API includes methods for

- Query stream type
- Query routed device
- Set device
- Query volume details
- Set volume
- Query mute details
- Set mute

AudioVoiceStream along with inheriting AudioStream, provides additional APIs to manage voice call session as stated below.

- Start Voice Audio Operation
- Stop Voice Audio Operation
- Play DTMF tone
- Detect DTMF tone

AudioPlayStream along with inheriting AudioStream, provides additional APIs to manage audio play session as stated below.

- Write audio samples
- Write audio samples for compressed audio format
- Stop Audio for compressed audio format
- Play compressed format audio on voice paths

AudioCaptureStream along with inheriting AudioStream, provides additional APIs to manage audio capture session as stated below.

- Read audio samples

AudioLoopbackStream along with inheriting AudioStream, provides additional APIs to manage audio loopback session as stated below.

- Start loopback
- Stop loopback

AudioToneGeneratorStream along with inheriting AudioStream, provides additional APIs to manage audio tone generator session as stated below.

- Play tone
- Stop tone

Transcoder provides APIs to manage audio transcoder which is able to perform below operations.

- Convert one audio format to another

Audio SDK provides details of supported "Device Types" and "Stream Types" in the audio subsystem of Reference Telematics platform.

“Device Type” encapsulates the type of device supported in Reference Telematics platform. The representation of these devices would be made available via public header file <usr/include/telux/audio/AudioDefines.hpp>.

Example: DEVICE\_TYPE\_XXXX

Internally SDK DeviceTypes are mapped to Audio HAL devices as per <usr/include/system/audio.h>.

In current release it is mapped per below table.

#### Current Device Mapping Table:

SDK Audio Device Representation	Audio HAL Representation
DEVICE_TYPE_SPEAKER	AUDIO_DEVICE_OUT_SPEAKER
DEVICE_TYPE_MIC	AUDIO_DEVICE_IN_BACK_MIC

However Device Mapping is configurable as stated below. This configurability provides flexibility to map different Audio HAL devices to SDK representation.

Update tel.conf file with below details before boot of system.

NUM\_DEVICES specifies the number of device types supported

DEVICE\_TYPE specifies the SDK type of each device (in comma separated values)

DEVICE\_DIR specifies the device direction for each device in order above (in comma separated values)

AHAL\_DEVICE\_TYPE specifies the mapped Audio HAL type of each device (in comma separated values)

Example:

Note: The default values provided here are based on QTI's reference design.

NUM\_DEVICES=6

DEVICE\_TYPE=1,2,3,257,258,259

DEVICE\_DIR=1,1,1,2,2,2

AHAL\_DEVICE\_TYPE=2,1,4,2147483776,2147483652,2147483664

For any stream types, maximum device supported would be one. Single stream per multiple devices not supported. For voice stream Rx Device would decide corresponding Tx Device pair as decided by Audio HAL.

#### NOTE FOR SYSTEM INTEGRATORS:

The mapping of Audio devices to Audio HAL devices is static currently based on QTI's Reference Telematics platform. For custom platforms this mapping need to be updated.

“Stream Type” encapsulates the type of stream supported in Reference Telematics Platform. The representation of these stream types made available via public header file  
<usr/include/telux/audio/AudioDefines.hpp>.

Example: VOICE\_CALL, PLAY, CAPTURE, LOOPBACK, TONE\_GENERATOR etc

#### Volume Support Table:

This table captures scenarios where the volume could be modified.

Stream Type	Stream Direction (RX)	Stream Direction (Tx)
VOICE_CALL	Applicable	Not Applicable
PLAY	Applicable	Not Applicable
CAPTURE	Not Applicable	Applicable
LOOPBACK	Not Applicable	Not Applicable
TONE_GENERATOR	Not Applicable	Not Applicable

In case QTI's reference design does not support volume for specific stream category, API responds with error.

#### Mute Support Table:

This table captures when stream could be muted and in which direction.

Stream Type	Stream Direction (RX)	Stream Direction (Tx)
VOICE_CALL	Applicable	Applicable
PLAY	Applicable	Not Applicable
CAPTURE	Not Applicable	Applicable
LOOPBACK	Not Applicable	Not Applicable
TONE_GENERATOR	Not Applicable	Not Applicable

In case QTI's reference design does not support mute for specific stream category, API responds with error.  
**Note:** If mute operations is performed for play or capture stream direction(Tx or RX), the stream will get muted irrespective of the direction provided.

## 2.2.10 Thermal Management

Thermal Management APIs in the Telematics SDK are used for reading thermal zone, cooling device and binding information.

Thermal Management APIs provide functionality such as

- get thermal zones with thermal zone description, current temperature, trip points and binding info
- get cooling devices with cooling device type, maximum and current cooling level

- get thermal zone by Id
- get cooling device by Id

## 2.2.11 Thermal Shutdown Management

Thermal Shutdown Management APIs provide functionality such as

- Query auto-shutdown mode.
- Set auto-shutdown mode.
- Get notifications on auto-shutdown mode updates.

## 2.2.12 TCU Activity Management

TCU-activity Manager APIs in Telematics SDK provides TCU-activity state related operations such as

- Set the activity state of the machines in TCU
- Get notifications about the imminent activity state changes on a machine in TCU
- Set the modem activity state
- Get all machine names
- Query the current TCU-activity state

## 2.2.13 Remote SIM

Remote SIM APIs in the Telematics SDK allow a device to use the WWAN capabilities of a SIM on another device.

Remote SIM APIs provide functionality such as

- Sending card events (reset, power up, errors) to the modem
- Sending/receiving APDU messages from/to the modem and remote SIM.
- Receiving operations from the modem (disconnect, power up, reset) to the remote SIM.

## 2.2.14 Modem Config Management

Modem Config APIs in the Telematics SDK provides modem config related functionalities such as

- Request modem config files from modem's storage.
- Load a modem config file to modem's storage.
- Activate/Deactivate a modem config file from modem's storage.
- Get Active config info details.
- Get/Set config auto selection mode.
- Delete a modem config file from modem's storage.
- Ability to get notified whenever a SW config file is activated.

## 2.2.15 Sensors

The sensor sub-system provides APIs to

- Configure and acquire continuous stream of data from an underlying sensor
- Create multiple clients for a given sensor, each of which can have their own configuration (sampling rate, batch count) for data acquisition.
- Query and control sensor features available on the hardware or those offered by the software framework. Availability of sensor features depend on the sensor hardware being used and the capabilities it offers.

In addition to the sensor sub-system APIs, configuration items relevant to the underlying sensors are also available in `/etc/sensors.conf` on the device filesystem. This includes the range for the sensors, the limits on sampling frequency and batch count among other parameters.

## 2.2.16 Platform

The platform sub-system provides APIs to

- Register and listen to filesystem events such as EFS backup and restore notifications
- Request EFS backup

## 2.2.17 Remote SIM Provisioning

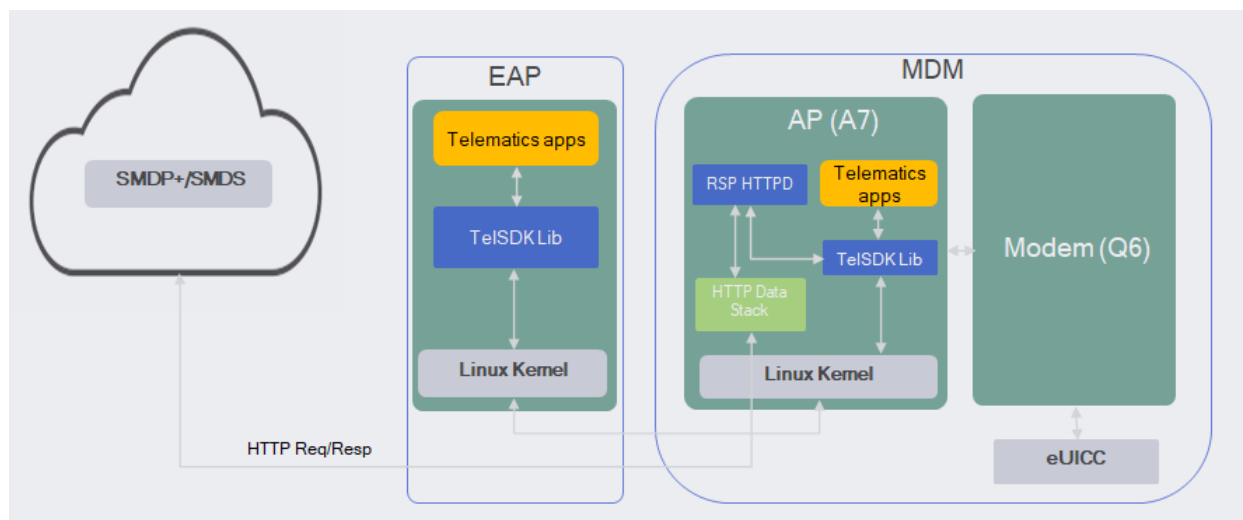

**Figure 2-2 Remote SIM Provisioning**

The Telematics Application can leverage Remote SIM Provisioning (RSP) APIs to perform eUICC profile management operations.

Remote SIM Provisioning APIs in Telematics SDK provides operations such as

- Download a profile on the eUICC. Allow downloading of profile based on activation code and confirmation code. Also provide user consent for downloading of profile.
- Enable or disable a profile to activate/deactivate subscription corresponding to profile.

- Delete a profile from an eUICC.
- Query list of profile on the eUICC.
- Get and update the server address( SMDP+ and SMDS)
- Get EID of the eUICC.
- Update nickname of the profile.
- Perform memory reset which allows to delete test and operational profiles or reset to default SMDP+ address.

When modem LPA/eUICC needs to reach SMDP+/SMDS server on the cloud for HTTP transaction, the HTTP request is sent to RSP service i.e RSP HTTP daemon. The RSP HTTP Daemon performs these HTTP transactions on behalf of modem with SMDP+/SMDS server running on the cloud. The HTTP response from cloud is sent back to modem LPA/eUICC to take appropriate action.

### 2.2.18 Debug Logger

Logging APIs in the Telematics SDK provides logging related functionalities such as

- Runtime configurable logging to console, diag and file.
- Possible LOG\_LEVEL values are NONE, PERF, ERROR, WARNING, INFO, DEBUG.

### 2.2.19 WLAN Management

WLAN management APIs in the Telematics SDK provide services related to the following Wi-Fi functionality.

- Enable/disable WLAN.
- Set/request WLAN mode: number of access points and number of stations to be enabled.
- Request current WLAN status.
- Set/request an access points configuration.
- Request access point status
- Set/request a station's configuration.
- Request station status
- Request list of devices connected to any access point.
- Restart hostapd and wpa\_supplicant daemons

### 2.2.20 Diagnostic Services

Two methods are supported to collect logs; file and callback method. In file method, logs are captured and saved to file. In callback method, log is passed to client provided callback whenever new log is generated. Logging is also provided per device or peripheral level. With device level logging, logs from all peripherals in that device is collected. With peripheral logging, logs from client selected peripherals only are captured. Diagnostic services APIs in the Telematics SDK provide the following functionality.

- Configure diagnostic services which include:



- Set logging level (Device/Peripheral).
- Set logging method (File/Callback).
- Set logging mode (Streaming, Threshold, or Circular Buffer).
- Set mask file for both modem and or EAP.
- Set max file size and max number of files generated if file method logging is selected.
- Start/Stop logging.

## 2.3 Subsystem Restart

Subsystem restart events occur when device operating system or services crashes due to any reason and then reboots to operational state. This section explains notifications that are sent to application when such an event occurs, the impact on application, notifications that are sent to application when device recovers to operating state, and suggested action application should take after recovery.

Examples of Subsystem Restart events:

- External application processor crash
- Modem application processor crash
- Modem processor crash

If application is running on either application processors when it crashes, application is expected to be restarted to initial state. For other scenarios, details are explained below for each subsystem.

### 2.3.1 Data Services

Data services behavior when Subsystem Restart event occur is shown in table below:

Telsdk Notifications	Impact	Recovery	Suggested Action
"onServiceStatusChange" notification with SERVICE_UNAVAILABLE "onDataCallInfoChanged" Notification with IDataCall object with DataCallStatus "NET_NO_NET".	Data calls impacted by SSR will be torn down and "NET_NO_NET" notifications will be delivered for those calls. Based on SSR type, it is possible that certain data calls will remain active. No "NET_NO_NET" notification will be delivered for active calls.	Application receives "onServiceStatusChange" notification with "SERVICE_AVAILABLE"	Re-trigger wwan data call for which "NET_NO_NET" notification was received.

Figure 2-3 Data SSR and Recovery

## 2.4 Security

## 2.4.1 SELinux

SELinux is an access control framework provided by the Linux kernel. It provides a mechanism to restrict/control access to system resources such as file nodes and sockets. SELinux framework expects any process running in userspace to declare all its interactions with the system resources in the form of SELinux policies. On platforms enabled with SELinux, an app that uses an SDK API would also need to declare its usage through SELinux policies to ensure that it has all the required permissions.

Listed below are the SELinux Interfaces which are generic for any API in particular namespace that app needs to declare in its policies.

**Note** For the below list, let us consider the application's security context to be `app_t` (also called domain context).

Namespace	SELinux interface	Arguments	Usage
tel	<code>telux_allow_tel()</code>	domain context	<code>telux_allow_tel(app_t)</code>
data	<code>telux_allow_data()</code>	domain context	<code>telux_allow_data(app_t)</code>
audio	<code>telux_allow_audio()</code>	domain context	<code>telux_allow_audio(app_t)</code>
loc	<code>telux_allow_loc()</code>	domain context	<code>telux_allow_loc(app_t)</code>
thermal	<code>telux_allow_thermalmanager()</code>	domain context	<code>telux_allow_thermalmanager(app_t)</code>
power	<code>telux_allow_power()</code>	domain context	<code>telux_allow_power(app_t)</code>
config	<code>telux_allow_modemconfig()</code>	domain context	<code>telux_allow_modemconfig(app_t)</code>
cv2x	<code>telux_allow_v2x()</code>	domain context	<code>telux_allow_v2x(app_t)</code>
sensor	<code>telux_allow_sensor()</code>	domain context	<code>telux_allow_sensor(app_t)</code>
platform	<code>telux_allow_platform()</code>	domain context	<code>telux_allow_platform(app_t)</code>

The following example illustrates how an application can incorporate the SELinux interfaces exposed by SDK in its SELinux policies. Below code snippet is part of a Type Enforcement (TE) file of the application which grants required permissions to perform SDK data operations.

```
policy_module(application, 1.0)
type app_t;

#Granting SDK data client permissions to the application

telux_allow_data(app_t);
```

In addition to the above SELinux interfaces list, below are the SELinux interfaces specific to a usecase. When an app needs to use any API, it should identify which SELinux interface to be used corresponding to the permission type from the below table and add it to the policy file.

To determine which permission type to be used for a API, please refer to the documentation for the API in the API Reference or in the API header file

**Note** The system integrator has the option to turn on/off this feature, where APIs related to a particular use case require certain permissions. If this feature is turned off, the use case specific permissions listed below are not required by the caller.

Tech Area	Permission Type	SELinux Interface
Audio	TELUX_AUDIO_VOICE	telux_allow_audio_voice
	TELUX_AUDIO_PLAY	telux_allow_audio_play
	TELUX_AUDIO_FACTORY_TEST	telux_allow_audio_factory_test
	TELUX_AUDIO_CAPTURE	telux_allow_audio_capture
	TELUX_AUDIO_TRANSCODE	telux_allow_audio_transcode
Data	TELUX_DATA_SETTING	telux_allow_data_setting
	TELUX_DATA_CALL_OPS	telux_allow_data_call_ops
	TELUX_DATA_CALL_PROPS	telux_allow_data_call_props
	TELUX_DATA_PROFILE_OPS	telux_allow_data_profile_ops
	TELUX_DATA_FILTER_OPS	telux_allow_data_filter_ops
	TELUX_DATA_NETWORK_CONFIG	telux_data_network_config
ModemConfig	TELUX_CONFIG_MODEM_CONFIG	telux_allow_config_modem_config
Power	TELUX_POWER_CONTROL_STATE	telux_allow_power_control_state_t
Sensor	TELUX_SENSOR_DATA_READ	telux_allow_sensor_data_read
	TELUX_SENSOR_PRIVILEGED_OPS	telux_allow_sensor_privileged_ops
	TELUX_SENSOR_FEATURE_CONTROL	telux_allow_sensor_feature_control
Telephony	TELUX_TEL_CARD_POWER	telux_allow_tel_card_power
	TELUX_TEL_CARD_OPS	telux_allow_tel_card_ops
	TELUX_TEL_PRIVATE_INFO_READ	telux_allow_tel_private_info_read
	TELUX_TEL_CARD_PRIVILEGED_OPS	telux_allow_tel_card_privileged_ops
	TELUX_TEL_SAP	telux_allow_tel_sap
	TELUX_TEL_CELL_BROADCAST_CONFIG	telux_allow_tel_cell_broadcast_config
	TELUX_TEL_CELL_BROADCAST_LISTEN	telux_allow_tel_cell_broadcast_listen
	TELUX_TEL_SIM_PROFILE_OPS	telux_allow_tel_sim_profile_ops
	TELUX_TEL_SIM_PROFILE_USER_CONSENT	telux_allow_tel_sim_profile_user_consent
	TELUX_TEL_SIM_PROFILE_CONFIG	telux_allow_tel_sim_profile_config
	TELUX_TEL_SIM_PROFILE_READ	telux_allow_tel_sim_profile_read
	TELUX_TEL_SIM_PROFILE_HTTP_PROXY	telux_allow_tel_sim_profile_http_proxy
	TELUX_TEL_REMOTE_SIM	telux_allow_tel_remote_sim
	TELUX_TEL_SMS_OPS	telux_allow_tel_sms_ops
	TELUX_TEL_SMS_LISTEN	telux_access_tel_sms_listen_t
	TELUX_TEL_SMS_CONFIG	telux_access_tel_sms_config
	TELUX_TEL_IMS_SETTINGS	telux_allow_tel_ims_settings
	TELUX_TEL_SRV_SYSTEM_CONFIG	telux_allow_tel_srv_system_config
	TELUX_TEL_SRV_SYSTEM_READ	telux_allow_tel_srv_system_read
	TELUX_TEL_NETWORK_SELECTION_OPS	telux_allow_tel_network_selection_ops
TELUX_TEL_NETWORK_SELECTION_READ	telux_allow_tel_network_selection_read	
TELUX_TEL_MULTISIM_MGMT	telux_allow_tel_multisim_mgmt	
TELUX_TEL_PRIVATE_INFO_READ	telux_allow_tel_private_info_read	

Tech Area	Permission Type	SELinux Interface
	TELUX_TEL_SUB_PRIVATE_INFO	telux_allow_tel_sub_private_info_read
	TELUX_TEL_SUBSCRIPTION_READ	telux_allow_tel_subscription_read
	TELUX_TEL_CALL_INFO_READ	telux_allow_tel_call_info_read
	TELUX_TEL_CALL_MGMT	telux_allow_tel_call_mgmt
	TELUX_TEL_CALL_PRIVATE_INFO	telux_allow_tel_call_private_info
	TELUX_TEL_EMERGENCY_OPS	telux_allow_tel_emergency_ops
	TELUX_TEL_ECALL_MGMT	telux_allow_tel_ecall_mgmt
	TELUX_TEL_PHONE_MGMT	telux_allow_tel_phone_mgmt
	TELUX_TEL_PRIVATE_INFO_READ	telux_access_tel_private_info_read
	TELUX_TEL_PHONE_CONFIG	telux_allow_tel_phone_config
	TELUX_TEL_ECALL_CONFIG	telux_allow_tel_ecall_config
	TELUX_TEL_SUPP_SERVICES	telux_allow_tel_supp_services

The following example illustrates how to declare permissions for an application that wants to use [telux::data::IDataConnectionManager::startDataCall\(\)](#) to setup a cellular data connection. The documentation of this API indicates that the caller needs to have TELUX\_DATA\_CALL\_OPS permission. From the above table, the permission maps to **telux\_allow\_data\_call\_ops** SELinux interface:

In order for the app to use the API the below code snippet needs to be entered in the Type Enforcement (TE) file of the application.

```
policy_module(application, 1.0)
type app_t;

#Allow data call operations

telux_allow_data_call_ops(app_t)
```

# 3 Call Flow Diagrams

## 3.1 Application initialization call flow

Telematics-SDK initializes various sub-systems during start-up. It marks each sub-system's service status as SERVICE\_AVAILABLE once the initialization procedures are completed for that sub-system. The application should pass callback function when requesting for manager object. This callback is invoked by underlying library which provides subsystem initialisation status. The application has to wait until the corresponding sub-system callback is invoked. Application should make API requests when service status is SERVICE\_AVAILABLE. Telematics-SDK provides APIs to fetch sub-system status.

Example:

### 3.1.1 Phone manager initialization

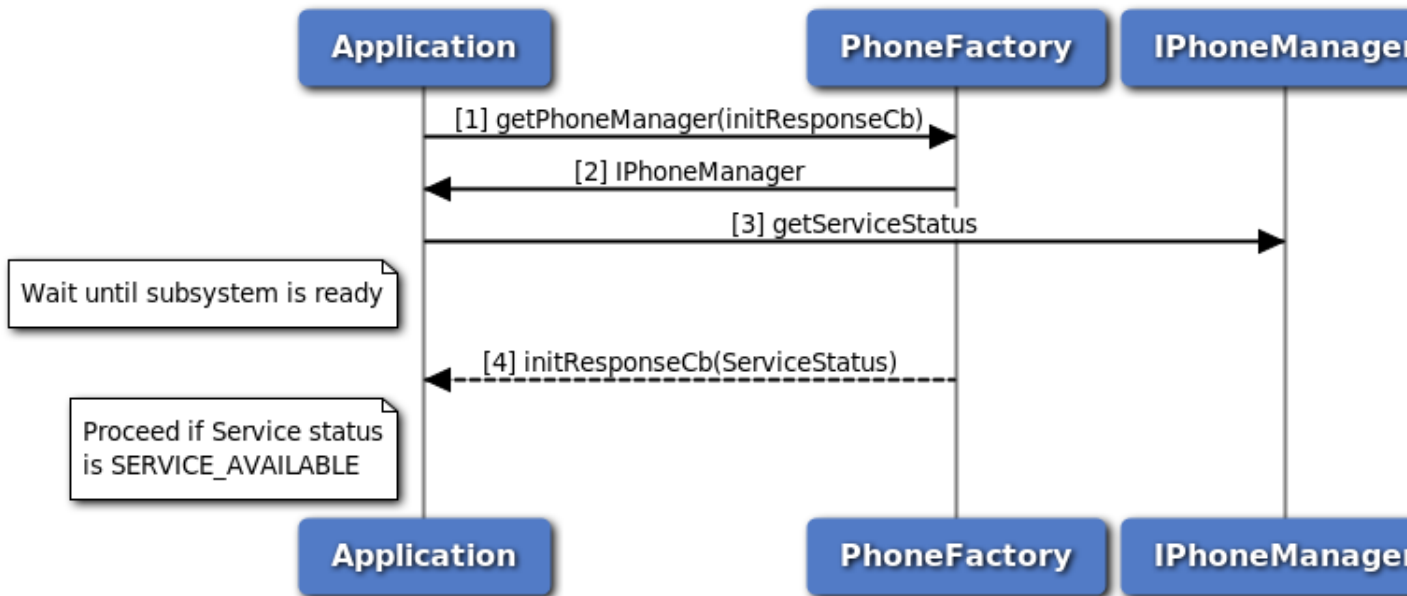

Figure 3-1 Phone manager initialization

1. Application uses PhoneFactory to call getPhoneManager by providing application callback function as parameter.
2. The application receives IPhoneManager.
3. Application requests for serviceStatus from IPhoneManager.

4. Application waits for the subsystem initialization callback, which notifies the subsystem initialization status.

## 3.2 Telephony

### 3.2.1 Dial call flow

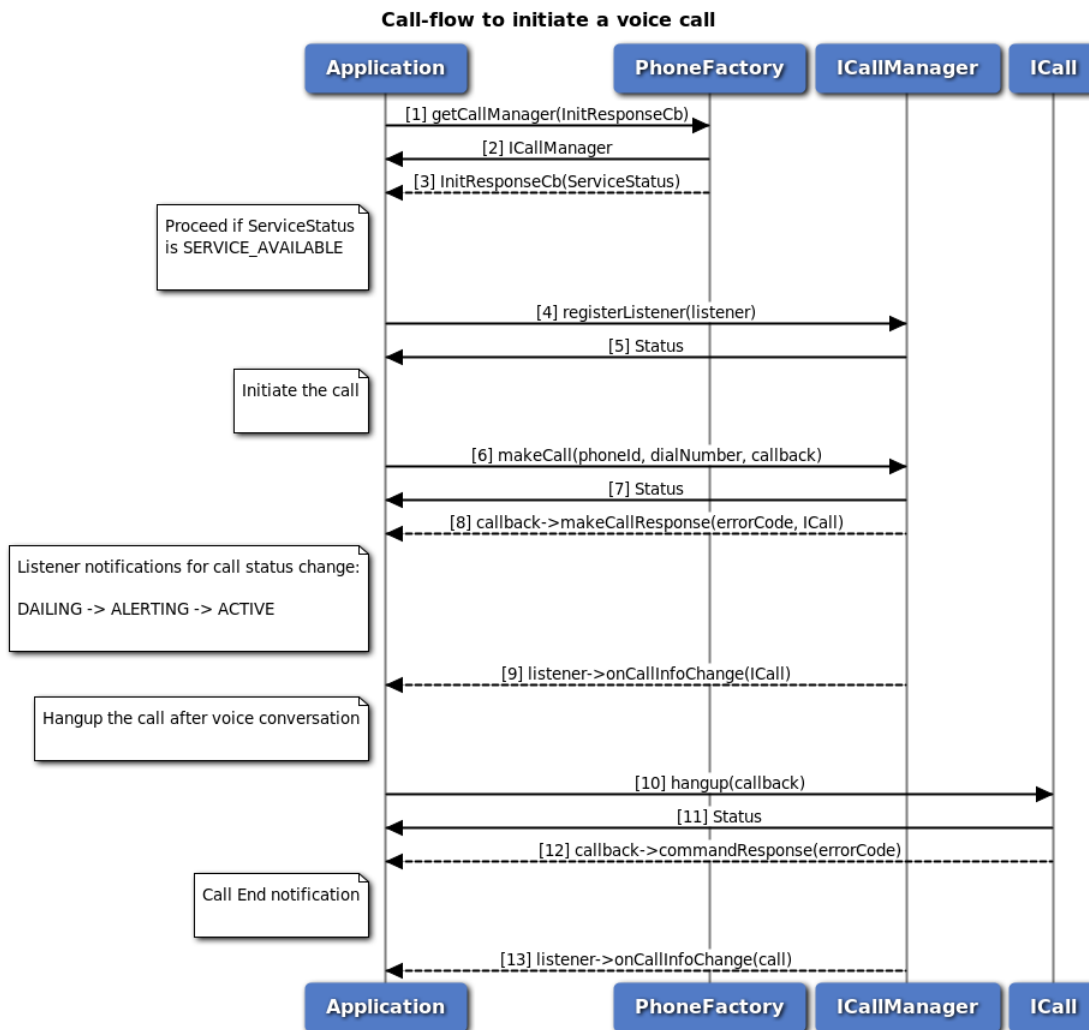
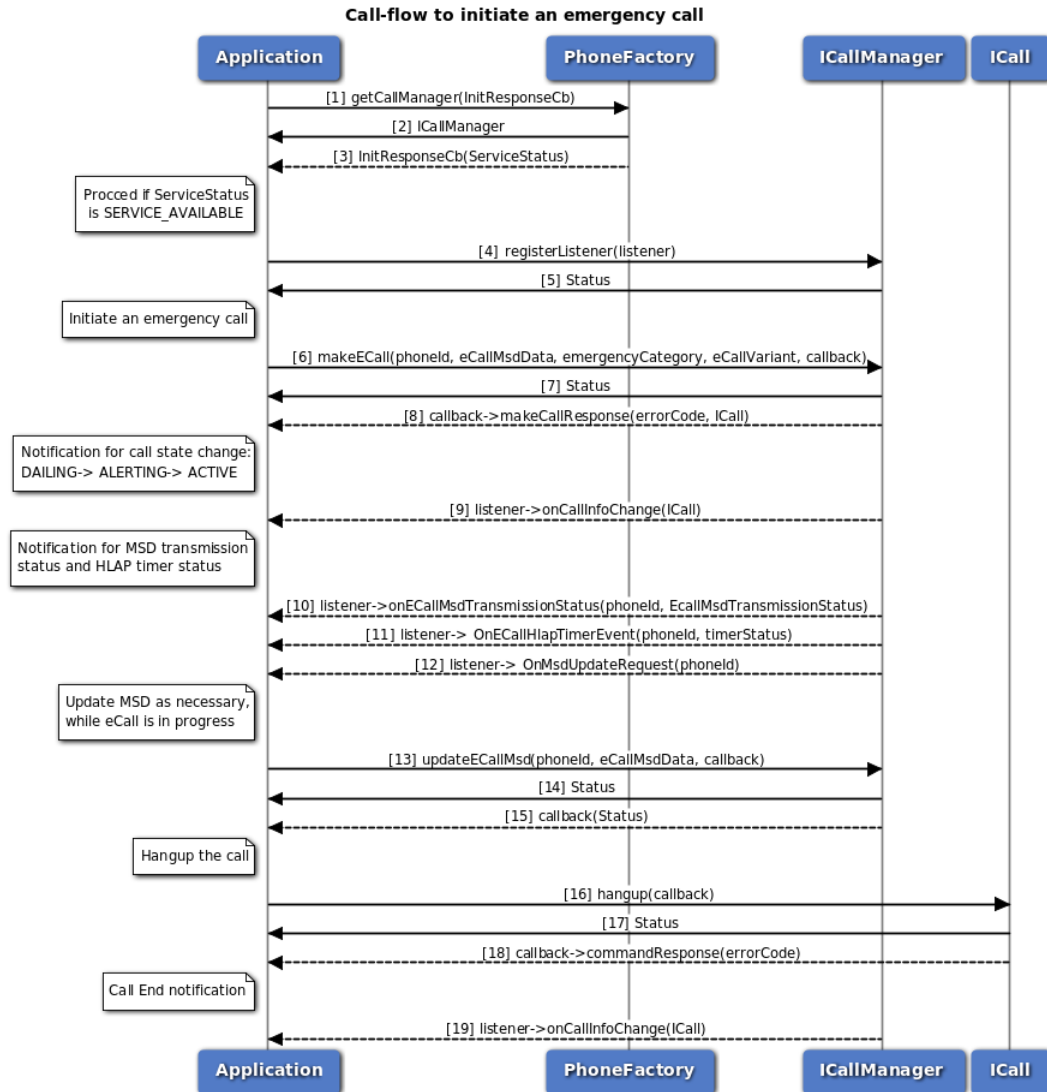

**Figure 3-2 Dial call flow**

1. Application requests an instance of Call Manager object using PhoneFactory, providing the initialization callback.
2. Application receives a Call Manager instance.
3. Application waits for the subsystem initialization callback, which notifies the subsystem initialization status.
4. If the subsystem is initialized successfully, application registers a listener for call info change notifications like DIALING, ALERTING, ACTIVE and ENDED.

5. Application receives the status(SUCCESS or suitable failure) based on registration of listener to CallManager.
6. Application dials a number by using makeCall API, optionally specifying callback to get asynchronous response.
7. Application receives the status(SUCCESS or suitable failure) based on the execution of makeCall API.
8. Optionally, the application gets asynchronous response for makeCall operation status, through makeCallResponse callback.
9. Application receives the listener notifications on call status change like DIALING/ALERTING/ACTIVE when other party accepts the call.
10. Application sends hangup command to hangup the call, optionally specifying callback to get asynchronous response.
11. Application receives the status(SUCCESS or suitable failure) based on the execution of hangup API.
12. Optionally, the application gets asynchronous response for hangup using CommandResponseCallback.
13. Application receives the listener notification for the call end notification.

### 3.2.2 ECall call flow



**Figure 3-3 ECall call flow**

1. Application requests an instance of Call Manager object using PhoneFactory, providing the initialization callback.
2. Application receives a Call Manager instance.
3. Application waits for the subsystem initialization callback, which notifies the subsystem initialization status.
4. If the subsystem is initialized successfully, application registers a listener for call info change notifications like DIALING, ALERTING, ACTIVE and ENDED.
5. Application receives the status(SUCCESS or suitable failure) based on registration of listener to CallManager.
6. Application dials a standard or NG emergency call by using makeECall API, optionally specifying callback to get asynchronous response.



7. Application receives the status(SUCCESS or suitable failure) based on the execution of makeECall API.
8. Optionally, the application gets asynchronous response for makeECall operation status, through makeCallResponse callback.
9. Application receives the listener notifications on call status change like DIALING/ALERTING/ACTIVE when other party accepts the call.
10. Application receives the listener notifications related to MSD transmission status updates.
11. Application receives the listener notifications related to eCall HLAP timer status updates.
12. CallManager sends MSD update request recieved from network to the application by using OnMsdUpdateRequest API.
13. Optionally, the application can update the MSD using updateECallMsd API, whenever there is an update to MSD.
14. Application receives the status(SUCCESS or suitable failure) based on the execution of updateECallMsd API.
15. Optionally, the application gets asynchronous response for updateECallMsd operation status.
16. Application sends hangup command to hangup the call, optionally specifying callback to get asynchronous response.
17. Application receives the status(SUCCESS or suitable failure) based on the execution of hangup API.
18. Optionally, the application gets asynchronous response for hangup using CommandResponseCallback.
19. Application receives the listener notification for the call end notification.

### 3.2.3 TPS eCall over IMS call flow

Private eCall:

1. It is a normal VOLTE call(to a custom number) with MSD information.
2. Application processor (AP) sends the MSD data at call connect and later AP gets an explicit indication, upon which it can provide updated MSD(unlike standard eCall where AP updates MSD constantly)
3. Device doesn't support fallback to CS. It is the AP's responsibility to retry over CS.
4. AP can send the MSD information data in non standard format and PSAP should be able to recognize it.

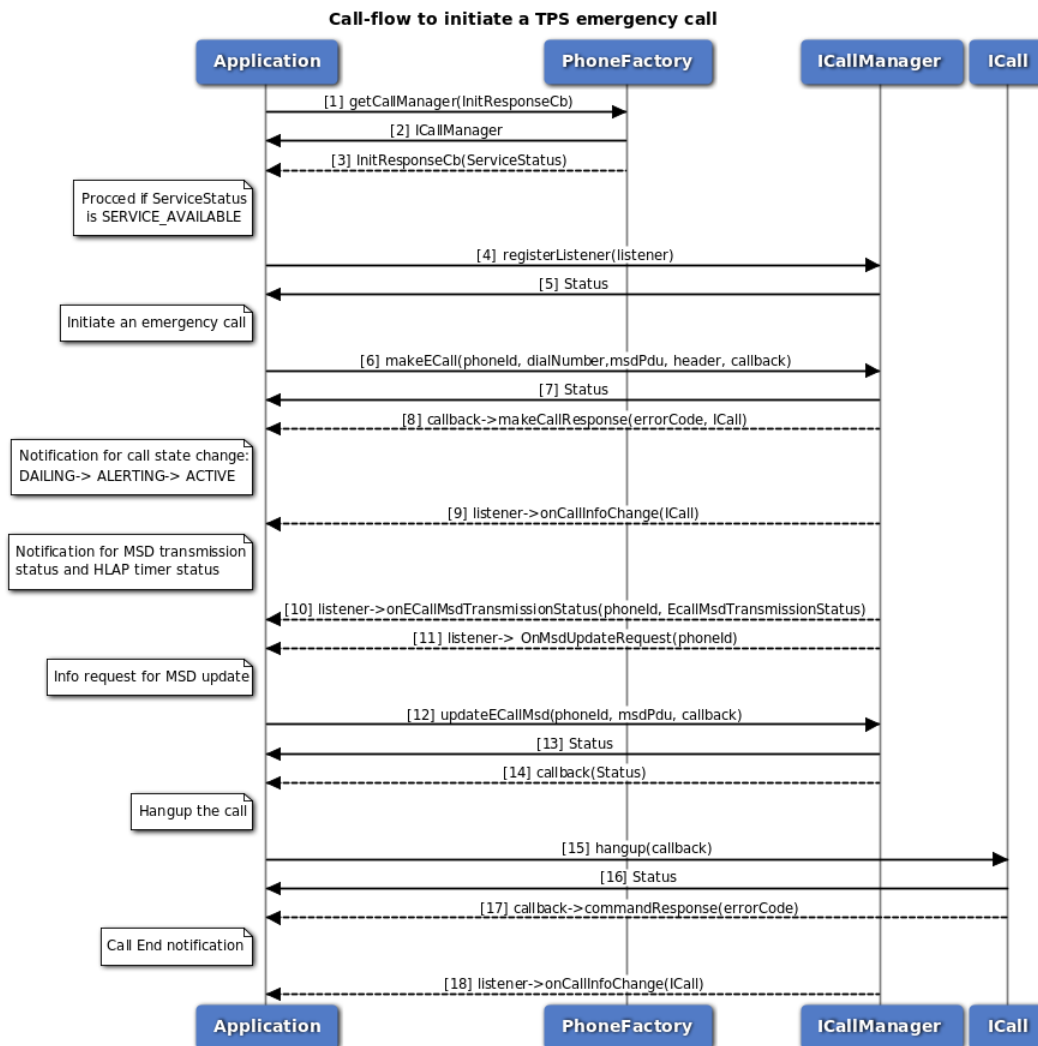

**Figure 3-4 ECall call flow**

1. Application requests an instance of Call Manager object using PhoneFactory, providing the initialization callback.
2. Application receives a Call Manager instance.

3. Application waits for the subsystem initialization callback, which notifies the subsystem initialization status.
4. The application registers a listener with CallManager to listen to the call info change notifications like DIALING, ALERTING, ACTIVE etc.
5. The application receives the status like SUCCESS, FAILED etc based on registration of listener from CallManager.
6. The application dials a TPS emergency call over IMS(i.e normal VOLTE call) by using makeECall API, optionally specifying header and callback to get asynchronous response.
7. The application receives the status like SUCCESS, FAILED etc based on the execution of makeECall API.
8. Optionally, the application gets asynchronous response for makeECall using makeCallResponseCallback.
9. Application receives the listener notifications on call status change like DIALING/ALERTING/ACTIVE when other party accepts the call.
10. CallManager sends eCall MSD transmission status to the application by using onECallMsdTransmissionStatus API.
11. CallManager sends MSD update request received from network to the application by using OnMsdUpdateRequest API.
12. The application sends the MSD data to network using updateECallMsd API, optionally specifying callback to get asynchronous response.
13. The application receives the status like SUCCESS, FAILED etc based on the execution of updateECallMsd API.
14. CallManager sends eCall MSD transmission status to the application by using onECallMsdTransmissionStatus API for MSD sent at step 10.
15. The application sends hangup command to hangup the call, optionally gets asynchronous response using callback.
16. The application receives the status like SUCCESS, FAILED etc based on the execution of hangup API.
17. Optionally, the application gets asynchronous response for hangup using CommandResponseCallback.
18. CallManager sends call info change i.e Call Ended to the application by using onCallInfoChange callback function.

### 3.2.4 Answer, Reject, RejectWithSMS call flow

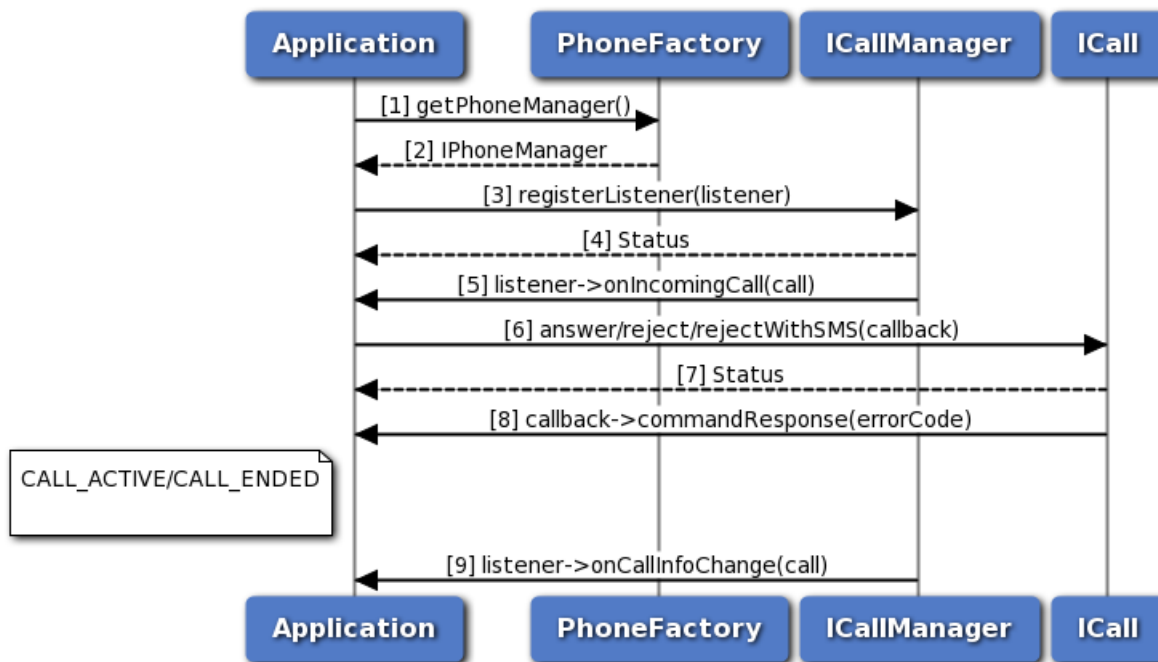
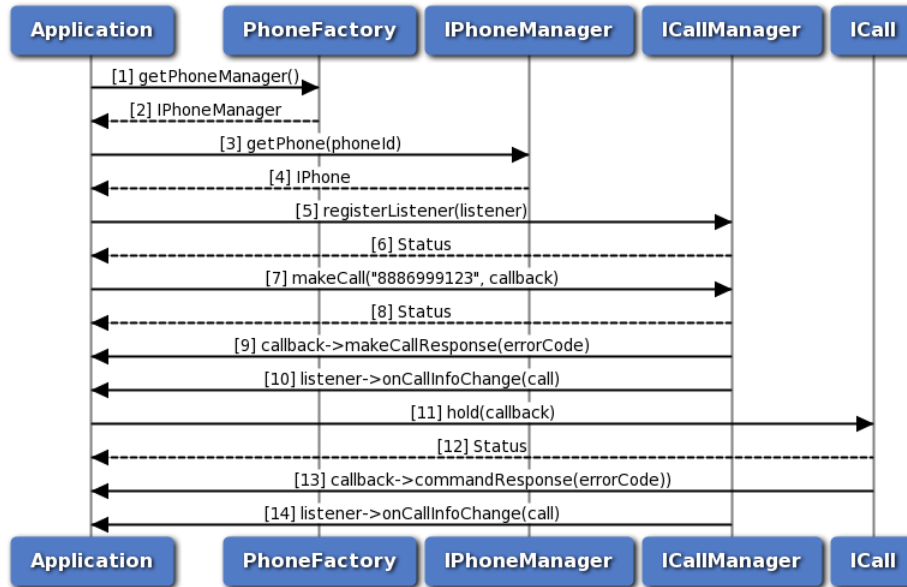

Figure 3-5 Answer, Reject, RejectWithSMS call flow

1. The application gets the PhoneManager object using PhoneFactory.
2. The application receives the PhoneManager object in order to register listener.
3. The application registers a listener with CallManager to listen incoming call notifications.
4. The application receives the status like SUCCESS, FAILED etc based on registration of listener from CallManager.
5. The application receives onIncomingCall notification when there is an incoming call.
6. The application performs answer/reject/rejectWithSMS operation using ICall.
7. The application receives the status like SUCCESS, FAILED etc based on execution of answer/reject/rejectWithSMS.
8. Optionally, the application gets asynchronous response for answer/reject/rejectWithSMS using CommandResponseCallback.
9. The CallManager sends call info change i.e CALL\_ACTIVE or CALL\_ENDED to the application by using onCallInfoChange callback function.

### 3.2.5 Hold call flow



**Figure 3-6 Hold call flow**

1. The application gets the PhoneManager object using PhoneFactory.
2. The application receives the PhoneManager object in order to get Phone.
3. The application gets the Phone object for given phone identifier using PhoneManager.
4. PhoneManager returns Phone object to application, returns default phone in case phone identifier is not specified.
5. The application registers a listener with CallManager to listen to the call info change notifications like DIALING, ALERTING, ACTIVE etc.
6. The application receives the status like SUCCESS or INVALIDPARAM based on registration of listener to CallManager.
7. The application dials a number by using makeCall API, optionally specifying callback to get asynchronous response.
8. The application receives the status like SUCCESS, INVALIDPARAM and FAILED etc based on the execution of makeCall API.
9. Optionally, the application gets asynchronous response for makeCall using makeCallResponseCallback.
10. The CallManager sends call info change i.e CALL\_ACTIVE to application by using onCallInfoChange API.
11. The application sends hold command to hold the call, optionally specifying callback to get asynchronous response.
12. The application receives the status like SUCCESS, FAILED etc based on the execution of hold API.
13. Optionally, the application gets asynchronous response for hold using CommandResponseCallback.
14. The application receives call info change i.e CALL\_ON\_HOLD from CallManager.

### 3.2.6 Hold, Conference, Swap call flow

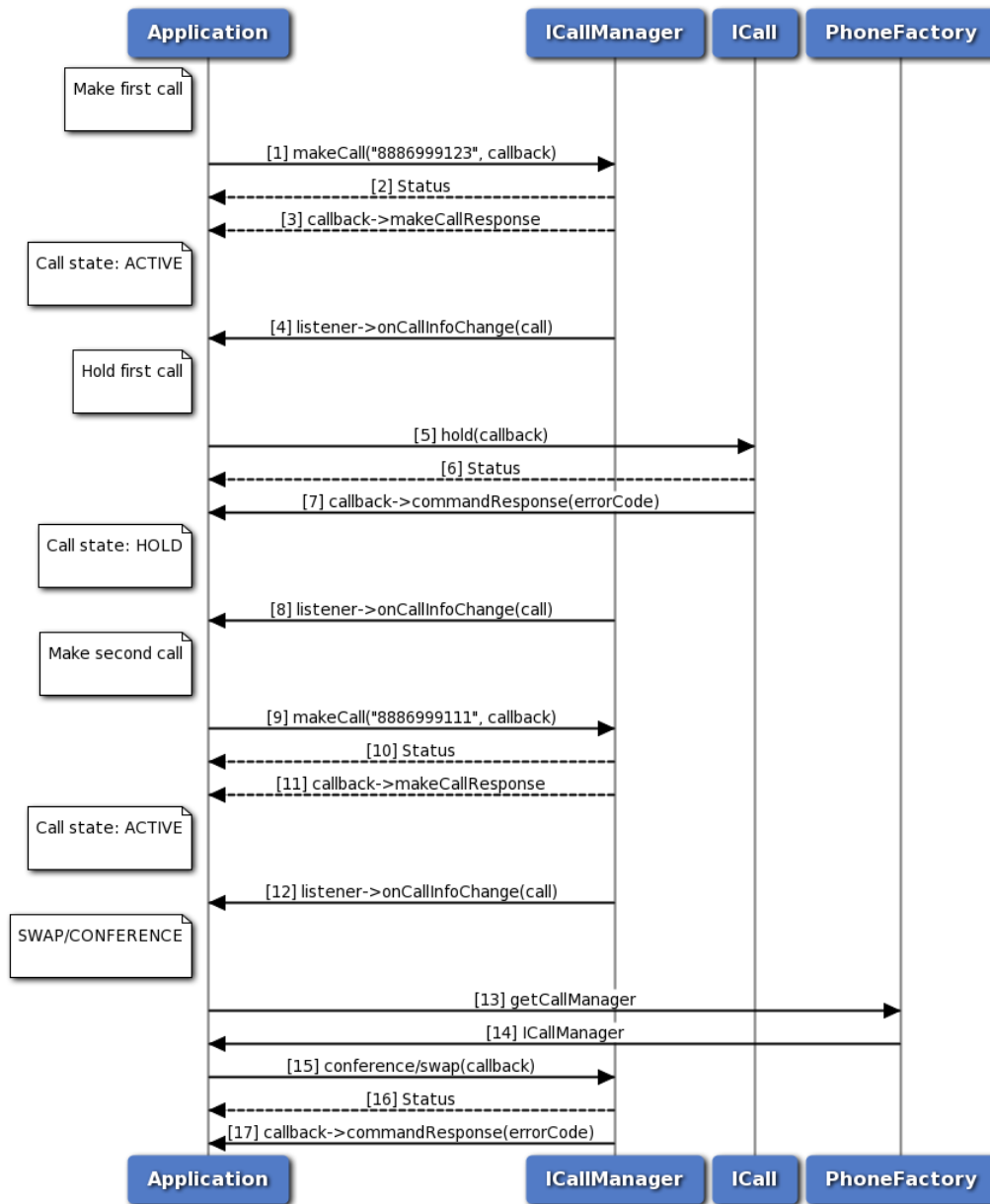

Figure 3-7 Hold, Conference, Swap call flow

1. The application makes first call using ICall.
2. The application receives the status like SUCCESS, FAILED etc based on execution of makeCall operation.
3. Optionally, the application gets asynchronous response for makeCall using makeCallResponseCallback.
4. The CallManager sends call info change i.e CALL\_ACTIVE to application by using onCallInfoChange API.
5. The application sends hold command to hold the call, optionally specifying callback to get

- asynchronous response.
6. The application receives the status like SUCCESS, FAILED etc based on the execution of hold API.
  7. Optionally, the application gets asynchronous response for hold using CommandResponseCallback.
  8. The application receives call info change i.e CALL\_ON\_HOLD from CallManager.
  9. The application makes second call using ICall.
  10. The application receives the status like SUCCESS, FAILED etc based on execution of makeCall operation.
  11. Optionally, the application gets asynchronous response for makeCall using makeCallResponseCallback.
  12. The CallManager sends call info change i.e CALL\_ACTIVE to application by using onCallInfoChange API.
  13. The application requests the PhoneFactory to get ICallManager object.
  14. The application receives the ICallManager object using PhoneFactory.
  15. The application performs conference/swap operation using ICallManager by passing first call and second call. optionally application can pass callback to receive hold response asynchronously.
  16. The application receives the status like SUCCESS, FAILED etc based on the execution of conference/swap API.
  17. Optionally, the application gets asynchronous response for conference/swap using CommandResponseCallback.

### 3.2.7 SMS call flow

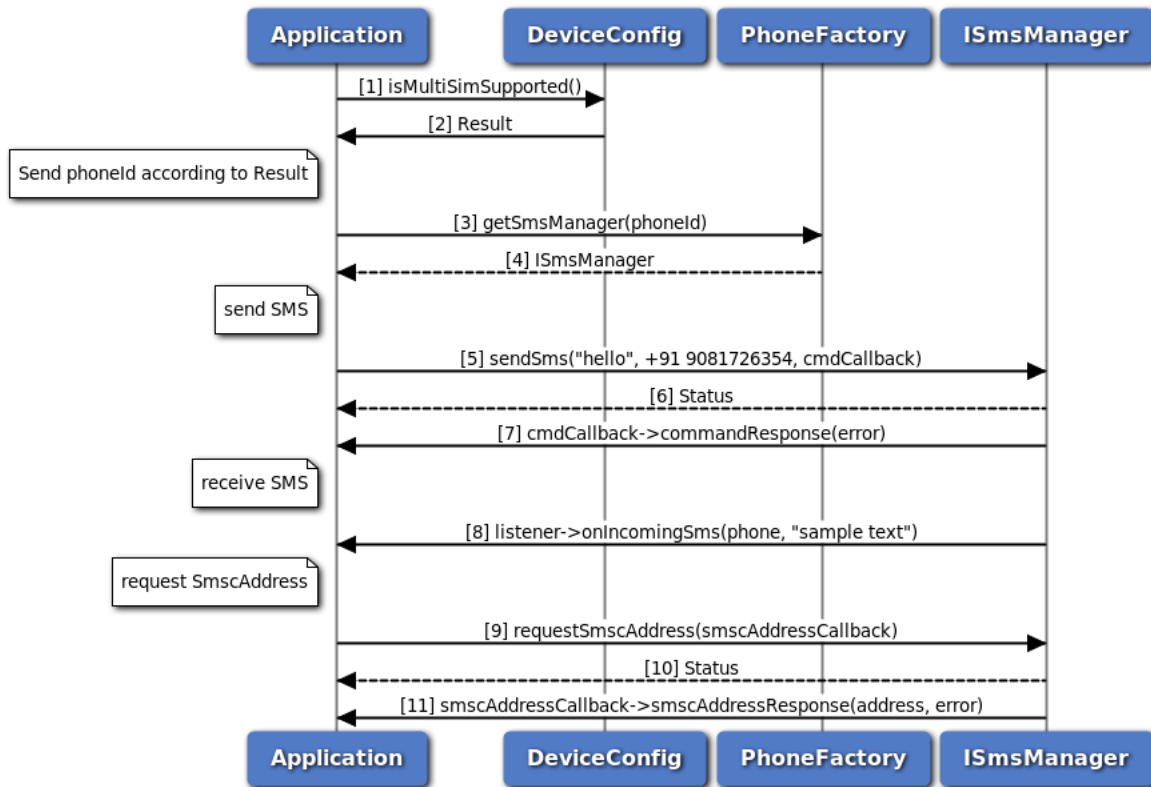

Figure 3-8 SMS call flow

1. Application requests to check multi sim configuration on device.
2. Application receives the result.
3. The application updates the list of phone identifier based on device configuration and gets SmsManager object corresponding to specific phone identifier.
4. PhoneFactory returns the SmsManager object to application in order to perform operations like send SMS and get SMSC address.
5. The application sends SMS to the receiver address and optionally gets asynchronous response using CommandResponseCallback.
6. Application receives the status i.e. either SUCCESS or FAILED based on execution of sendSms API in SmsManager.
7. Optionally, the response for send SMS is received by the application.
8. Application gets notified for incoming SMS.
9. The application requests for SmscAddress and optionally gets asynchronous response using ISmscAddressCallback.
10. Application receives the status i.e. either SUCCESS or FAILED based on successful execution of requestSmscAddress API in SmsManager.
11. Optionally, the application receives the SMSC address on success or gets error on failure in the command response callback.



### 3.2.8 Signal strength call flow

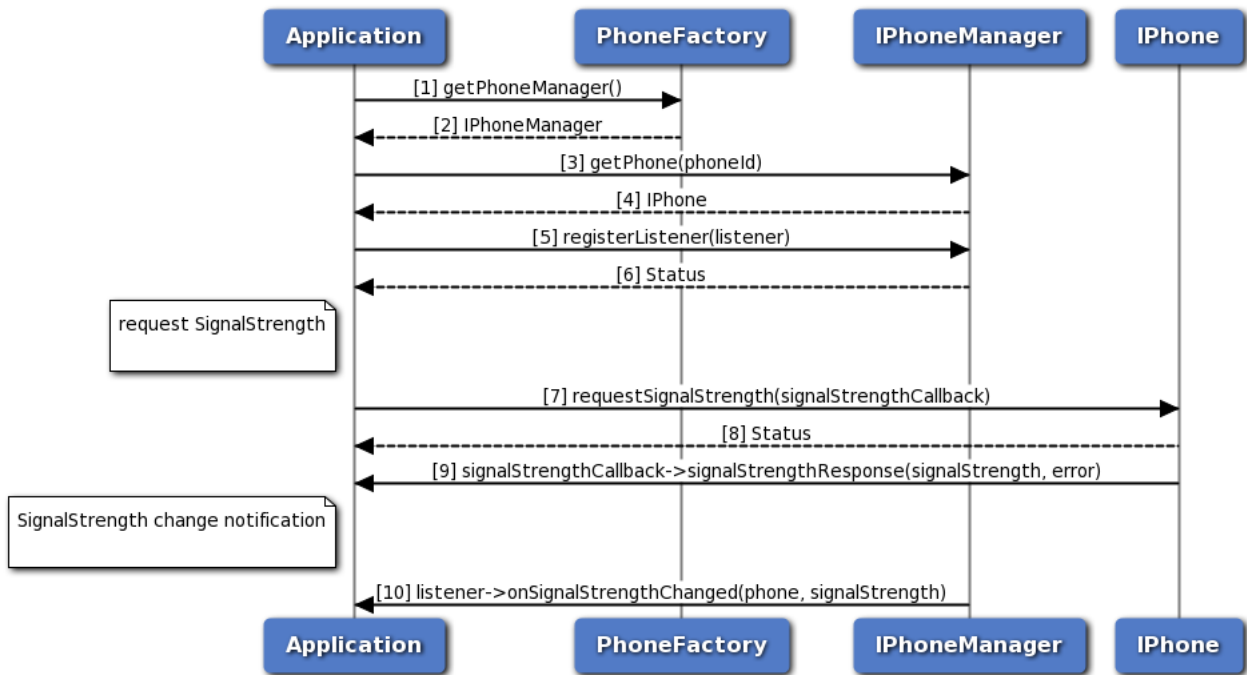

Figure 3-9 Signal strength call flow

1. The application gets PhoneManager object using PhoneFactory.
2. The application receives the PhoneManager object in order to get Phone instance.
3. The application gets phone instance for a given phone identifier using PhoneManager object.
4. PhoneManager returns iPhone object to the application.
5. Application registers the listener to get notification for signal strength change.
6. The application receives the status i.e. either SUCCESS or FAILED based on the registration of the listener.
7. The application requests for signal strength and optionally, gets asynchronous response using ISignalStrengthCallback.
8. The application receives the status i.e. either SUCCESS or FAILED based on execution of requestSignalStrength API in SapCardManager.
9. Optionally, the response for signal strength request is received by the application.
10. Application receives a notification when there is a change in signal strength.

### 3.2.9 CellBroadcast Call Flow

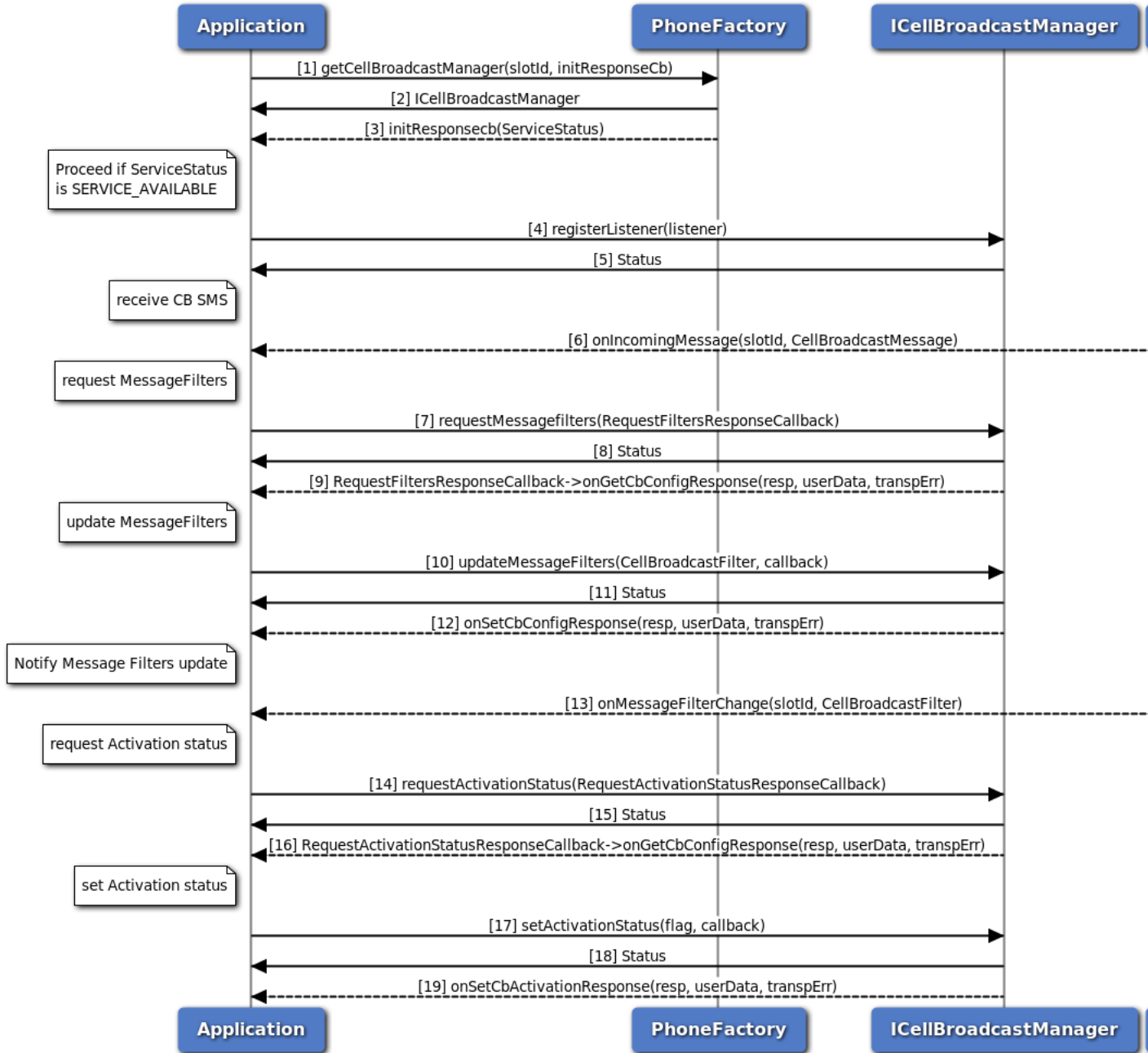

Figure 3-10 CellBroadcast call flow

1. Application requests an instance of CellBroadcast Manager object using PhoneFactory, providing the initialization callback.
2. Application receives a CellBroadcast Manager instance.
3. Application waits for the subsystem initialization callback, which notifies the subsystem initialization status.
4. If the subsystem is initialized successfully, application registers to ICellBroadcastListener for

- incoming Cell broadcast messages and message filter changes.
- 5. The application receives the status i.e. either SUCCESS or INVALIDPARAM based on successful registration of the listener.
- 6. Application gets notified for incoming CellBroadcast Message by ICellBroadcastListener.
- 7. The application requests for message filters and gets response with RequestFiltersResponseCallback.
- 8. Application receives the status i.e. either SUCCESS or FAILED based on successful execution of requestMessageFilters API in CellBroadcastManager.
- 9. The application gets asynchronous response for requestMessageFilters through RequestFiltersResponseCallback.
- 10. Application can configure/update message filters by specifying message filters and gets response with optional callback.
- 11. Application receives the status i.e. either SUCCESS or FAILED based on successful execution of updateMessageFilters API in CellBroadcastManager.
- 12. Optionally, the application gets asynchronous response for updateMessagefilters.
- 13. Application gets notified for updated message filters for CellBroadcast Message.
- 14. The application requests for activation status and gets response with RequestActivationStatusResponseCallback.
- 15. Application receives the status i.e. either SUCCESS or FAILED based on successful execution of requestActivationStatus API in CellBroadcastManager.
- 16. The application gets asynchronous response for requestActivationStatus through RequestActivationStatusResponseCallback.
- 17. Application can activate/deactivate configured broadcast messages by setActivationStatus.
- 18. Application receives the status i.e. either SUCCESS or FAILED based on successful execution of setActivationStatus API in CellBroadcastManager.
- 19. Optionally, the application gets asynchronous response for setActivationStatus.

### 3.2.10 Radio and Service state call flow

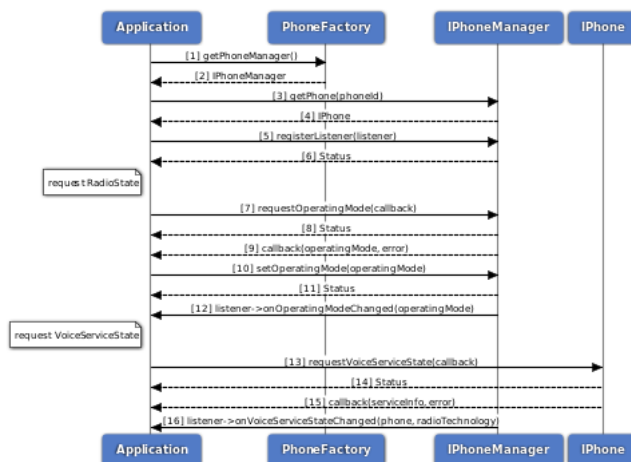

Figure 3-11 Radio and Service state call flow

1. The application gets PhoneManager object using PhoneFactory.
2. The application receives the PhoneManager object in order to get Phone instance.
3. The application gets phone instance for a given phone identifier using PhoneManager object.
4. PhoneManager returns IPhone object to the application.
5. Application registers the listener to get notifications for radio and service state change.
6. The application receives the status i.e. either SUCCESS or FAILED based on the registration of the listener.
7. The application request the PhoneManager to get operatingMode of device.
8. The application receives the status i.e. either SUCCESS or FAILED.
9. The application receives the callback of the request with the information of current operating mode of device.
10. The application request the PhoneManager to set operatingMode of device.
11. The application receives the status i.e. either SUCCESS or FAILED.
12. Application receives a notification when there is a change in operatingMode.
13. The application request the PhoneManager to get voice service state.
14. The application receives the status i.e. either SUCCESS or FAILED.
15. The application receives the voice service state, radio technology information etc.
16. Application receives a notification when there is a change in voice service state.

### 3.2.11 Network Selection Manager call flow

Network selection manager provides APIs to get and set network selection mode, get and set preferred networks and perform network scan for available networks. Registered listener will get notified for the change in network selection mode.

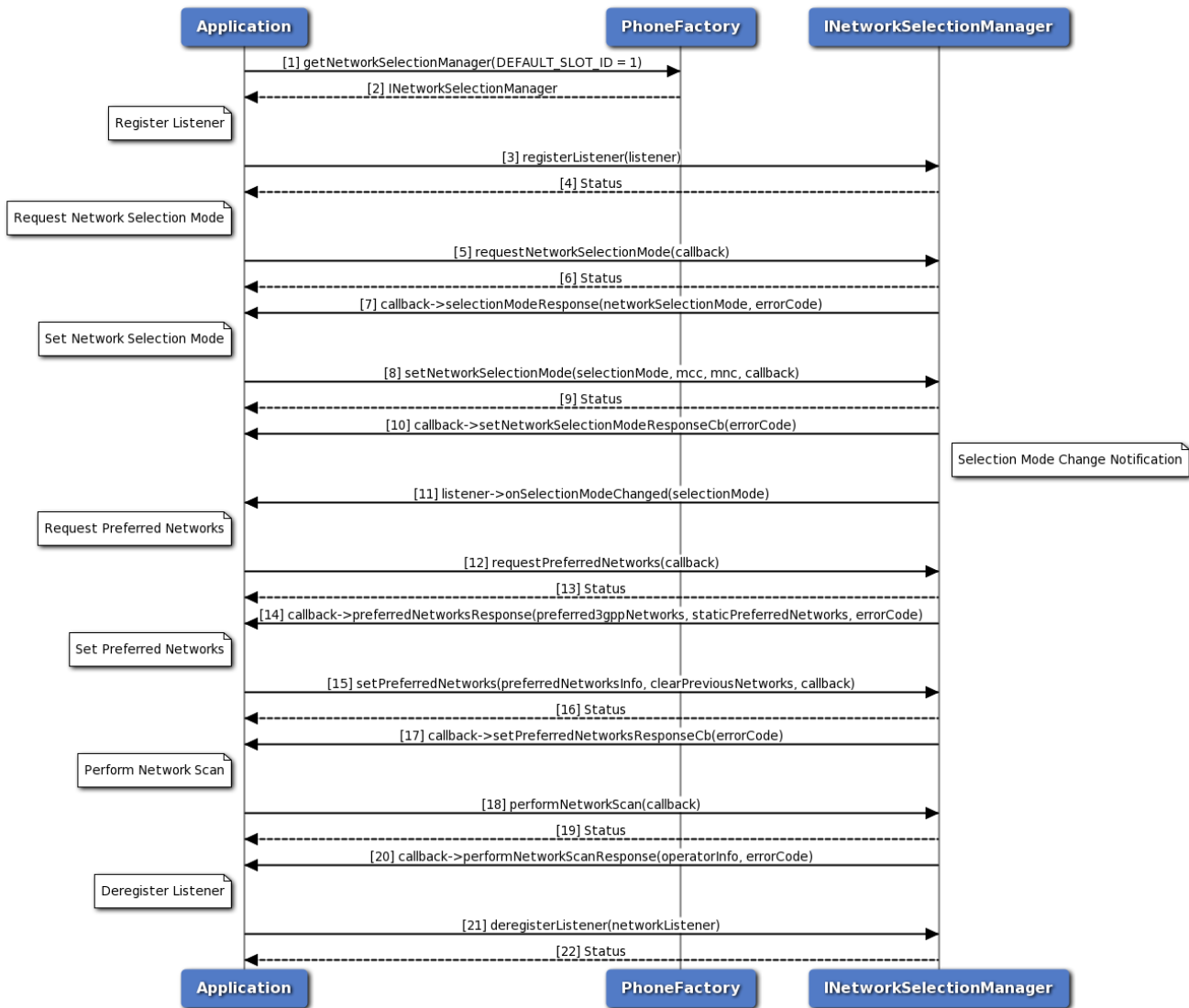

Figure 3-12 Network selection manager call flow

1. Application requests phone factory for network selection manager.
2. Phone factory returns INetworkSelectionManager object using which application will register or deregister a listener.
3. Application can register a listener to get notifications for network selection mode change.
4. Status of register listener i.e. either SUCCESS or other status will be returned to the application.
5. Application requests for network selection mode using INetworkSelectionManager object and gets asynchronous response using SelectionModeResponseCallback.

6. The application receives the status i.e. either SUCCESS or other status based on the execution of requestNetworkSelectionMode API.
7. The response for get network selection mode request is received by the application.
8. The application can also set network selection mode and optionally gets asynchronous response using ResponseCallback. MCC and MNC are optional for AUTOMATIC network selection mode.
9. Application receives the status i.e. either SUCCESS or other status based on the execution of setNetworkSelectionMode API.
10. Optionally the response for set network selection mode request is received by the application.
11. Registered listener will get notified for the network selection mode change.
12. Similarly, the application requests for preferred networks using INetworkSelectionManager object and gets asynchronous response using PreferredNetworksCallback.
13. The application receives the status i.e. either SUCCESS or other status based on the execution of requestPreferredNetworks API.
14. The response for get preferred networks request i.e. 3GPP preferred network list and static 3GPP preferred network list is received by the application asynchronously. Higher priority networks appear first in the list. The networks that appear in the 3GPP Preferred Networks list get higher priority than the networks in the static 3GPP preferred networks list.
15. The application can set 3GPP preferred network list and optionally gets asynchronous response using ResponseCallback. If clear previous networks flag is false then new 3GPP preferred network list is appended to existing preferred network list. If flag is true then old list is flushed and new 3GPP preferred network list is added.
16. Application receives the status i.e. either SUCCESS or other status based on the execution of setPreferredNetworks API.
17. Optionally the response for set preferred networks request is received by the application.
18. The application can perform network scan for available networks using INetworkSelectionManager object and gets asynchronous response using NetworkScanCallback.
19. Application receives the status i.e. either SUCCESS or other status based on the execution of performNetworkScan API.
20. Network name, MCC, MNC and status of the operator will be received by the application.
21. Application can deregister a listener there by it would not get notifications.
22. Status of deregister listener i.e. either SUCCESS or other status will be returned to the application.

### 3.2.12 Serving System Manager Call Flow

Serving system manager provides APIs to get and set RAT mode preference and get and set service domain preference. Registered listener will get notified for the change in RAT mode and service domain preference change.

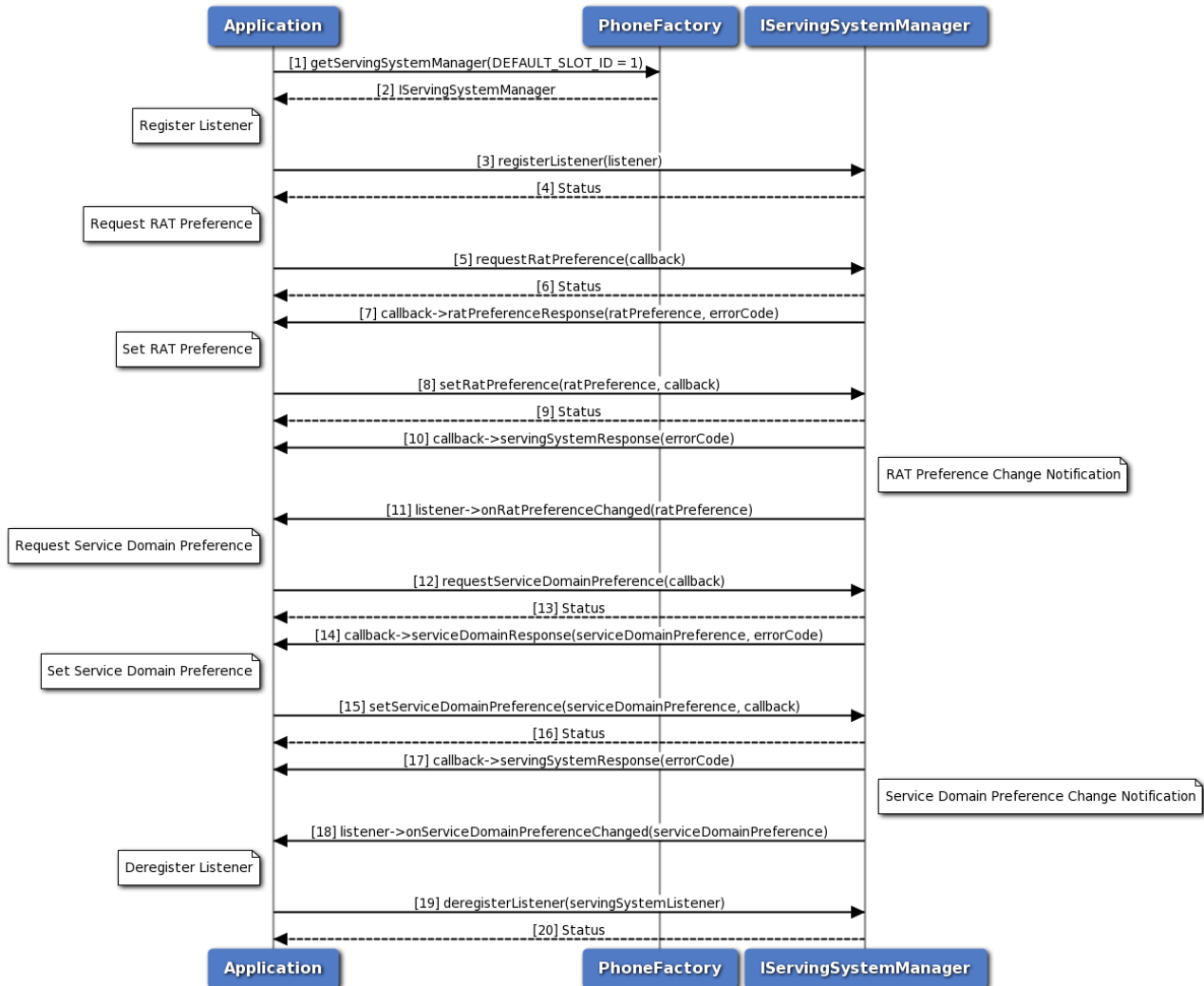

Figure 3-13 Serving System Manager Call Flow

1. Application requests phone factory for serving system manager.
2. Phone factory returns `IServingSystemManager` object using which application will register or deregister a listener.
3. Application can register a listener to get notifications for RAT mode and service domain preference changes.
4. Status of register listener i.e. either SUCCESS or other status will be returned to the application.
5. Application requests for RAT mode preference using `IServingSystemManager` object and gets asynchronous response using `RatPreferenceCallback`.

6. The application receives the status i.e. either SUCCESS or other status based on the execution of requestRatPreference API.
7. The response for get RAT preference request is received by the application.
8. The application can also set RAT mode preference and optionally gets asynchronous response using ResponseCallback.
9. Application receives the status i.e. either SUCCESS or other status based on the execution of setRatPreference API.
10. Optionally the response for set RAT preference request is received by the application.
11. Registered listener will get notified for the RAT mode preference change.
12. Application requests for service domain preference using IServingSystemManager object and gets asynchronous response using ServiceDomainPreferenceCallback.
13. The application receives the status i.e. either SUCCESS or other status based on the execution of requestServiceDomainPreference API.
14. The response for get service domain preference request is received by the application.
15. The application can also set service domain preference and optionally gets asynchronous response using ResponseCallback.
16. Application receives the status i.e. either SUCCESS or other status based on the execution of setServiceDomainPreference API.
17. Optionally the response for set service domain preference request is received by the application.
18. Registered listener will get notified for the service domain preference change.
19. Application can deregister a listener there by it would not get notifications.
20. Status of deregister listener i.e. either SUCCESS or other status will be returned to the application.



### 3.2.13 Card-Get applications call flow

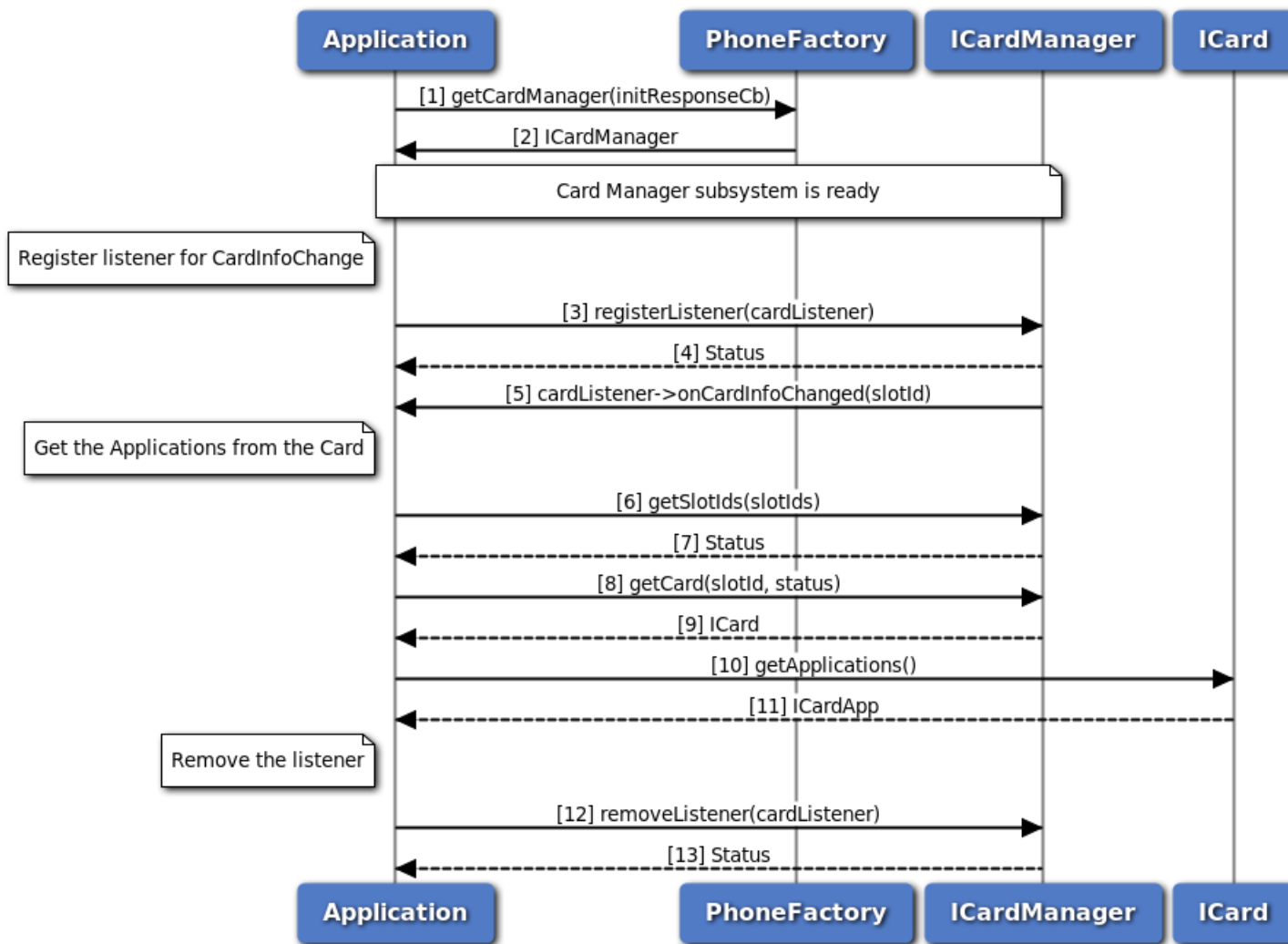

Figure 3-14 Card-Get applications call flow

1. Application gets the CardManager object from PhoneFactory.
2. Application receives CardManager object in order to perform operations like getSlotIds and getCard.
3. The application registers a listener for Card info change event with CardManager.
4. Application receives the status i.e. either SUCCESS or INVALIDPARAM based on the registration of listener.
5. The response from onCardInfoChanged is received by the application whenever there is card info change.
6. The application gets the slotIds from the sub-system using CardManager.
7. Application receives the status i.e. either SUCCESS or NOTREADY along with the updated slotIds.
8. Then, the application sends request to CardManager to get Card object for a specific slotId.

9. Application receives Card object from CardManager in order to perform card operation like getApplications.
10. The application gets the CardApps from Card object.
11. The application receives CardApps which contain information such as AppId, AppType and AppState.
12. Now the application removes the listener associated with CardManager.
13. Application receives the status i.e. either SUCCESS or NOSUCH for the removal of listener.

### 3.2.14 Card-Transmit APDU call flow

#### 3.2.14.1 On logical channel

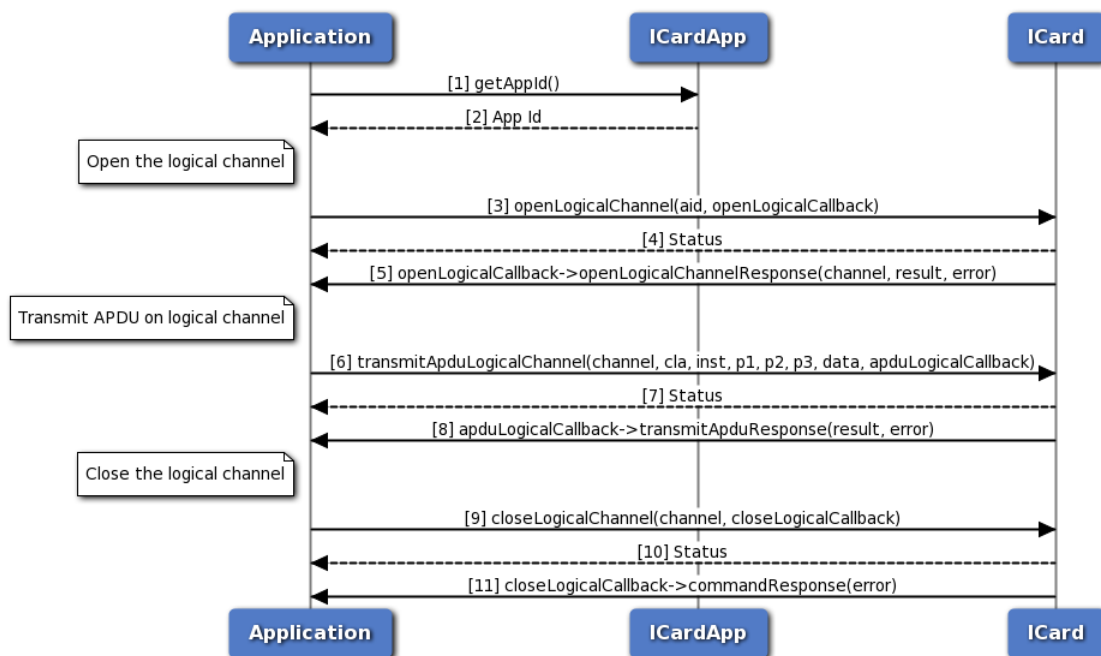

Figure 3-15 On logical channel

1. The Application requests CardApp for the SIM application identifier.
2. The application receives the application identifier to perform open logical channel.
3. Application sends request to open the logical channel with the application identifier and optionally, gets asynchronous response in OpenLogicalChannelCallback.
4. The application receives the status i.e. either SUCCESS or FAILED based on execution of openLogicalChannel API.
5. Optionally, the application receives the response which contains either channel number on success or error in case of failure.
6. Then, the application transmits the APDU data on logical channel using the channel obtained earlier. Optionally, gets asynchronous response in TransmitApuResponseCallback.
7. The application receives the status i.e. either SUCCESS or FAILED based on execution of

transmitApduLogicalChannel API.

8. Optionally, the application receives the response which contains either result on success or error in case of failure.
9. Finally, the application closes the logical channel that is opened to transmit APDU and optionally, gets asynchronous response in CommandResponseCallback.
10. The application receives the status i.e. either SUCCESS or FAILED based on execution of closeLogicalChannel API.
11. Optionally, the application receives the response which contains error in case of failure.

### 3.2.14.2 On basic channel

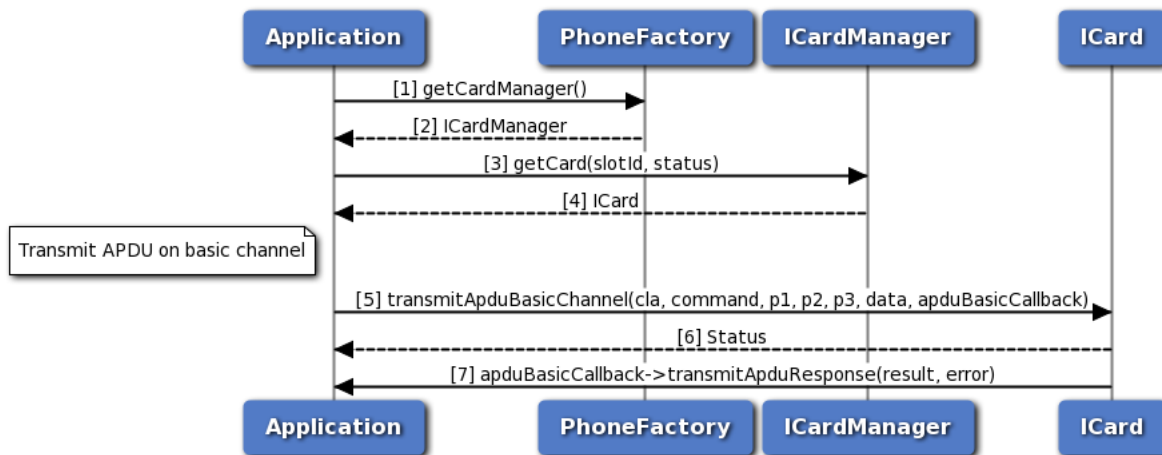
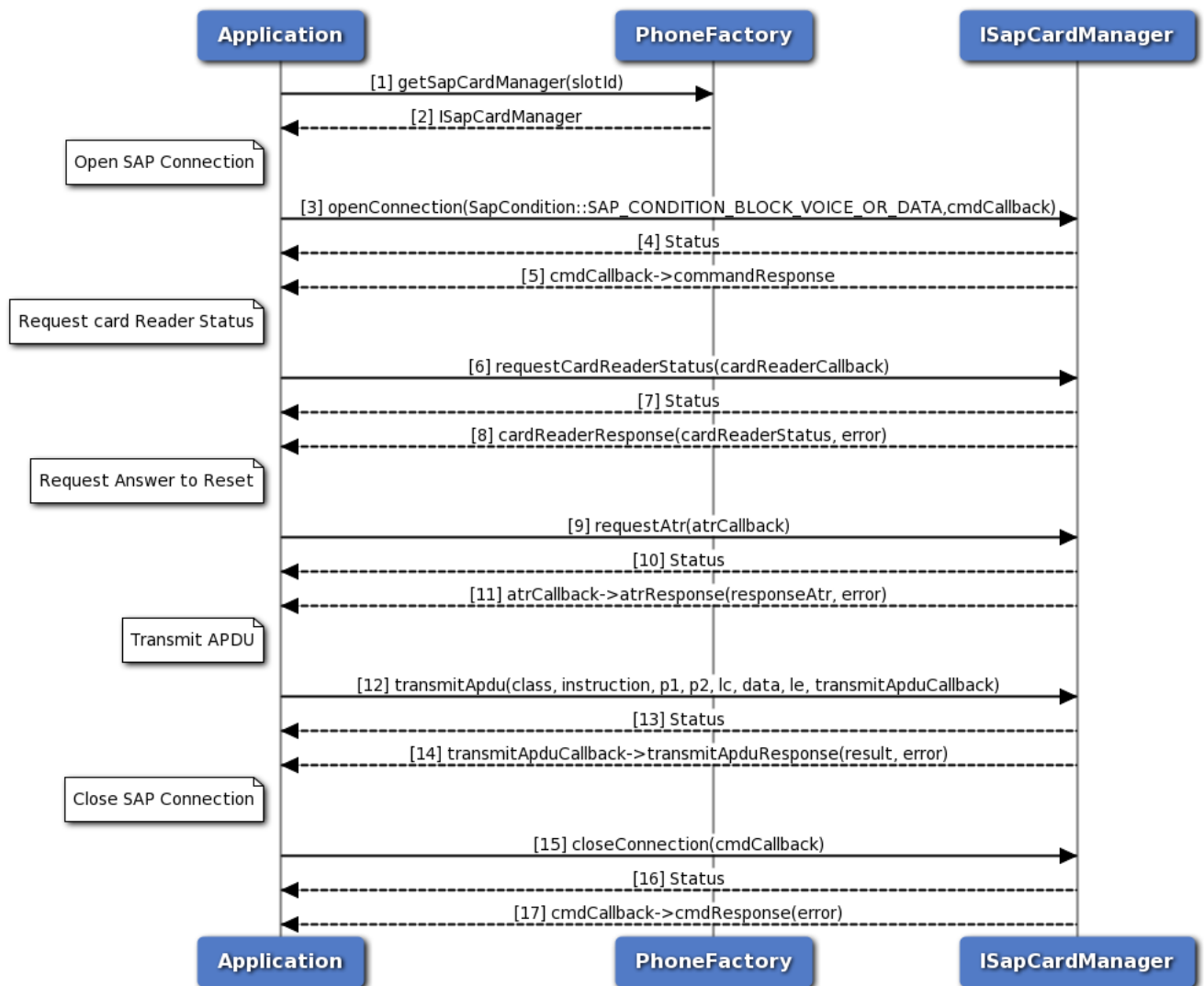

Figure 3-16 On basic channel

1. Application gets the ICardManager object from PhoneFactory.
2. Application receives ICardManager object in order to perform operation like getCard.
3. The application gets ICard object for a specific slotId from ICardManager.
4. Application receives ICard object in order to perform card operation like transmitApduBasicChannel.
5. The application transmits APDU data on basic channel and optionally, gets asynchronous response in TransmitApduResponseCallback.
6. The application receives the status i.e. either SUCCESS or FAILED based on execution of transmitApduBasicChannel API.
7. Optionally, the application receives the response which contains either result on success or error in case of failure.

### 3.2.15 SAP card manager call flow

### 3.2.15.1 Request card reader status, Request ATR, Transmit APDU call flow

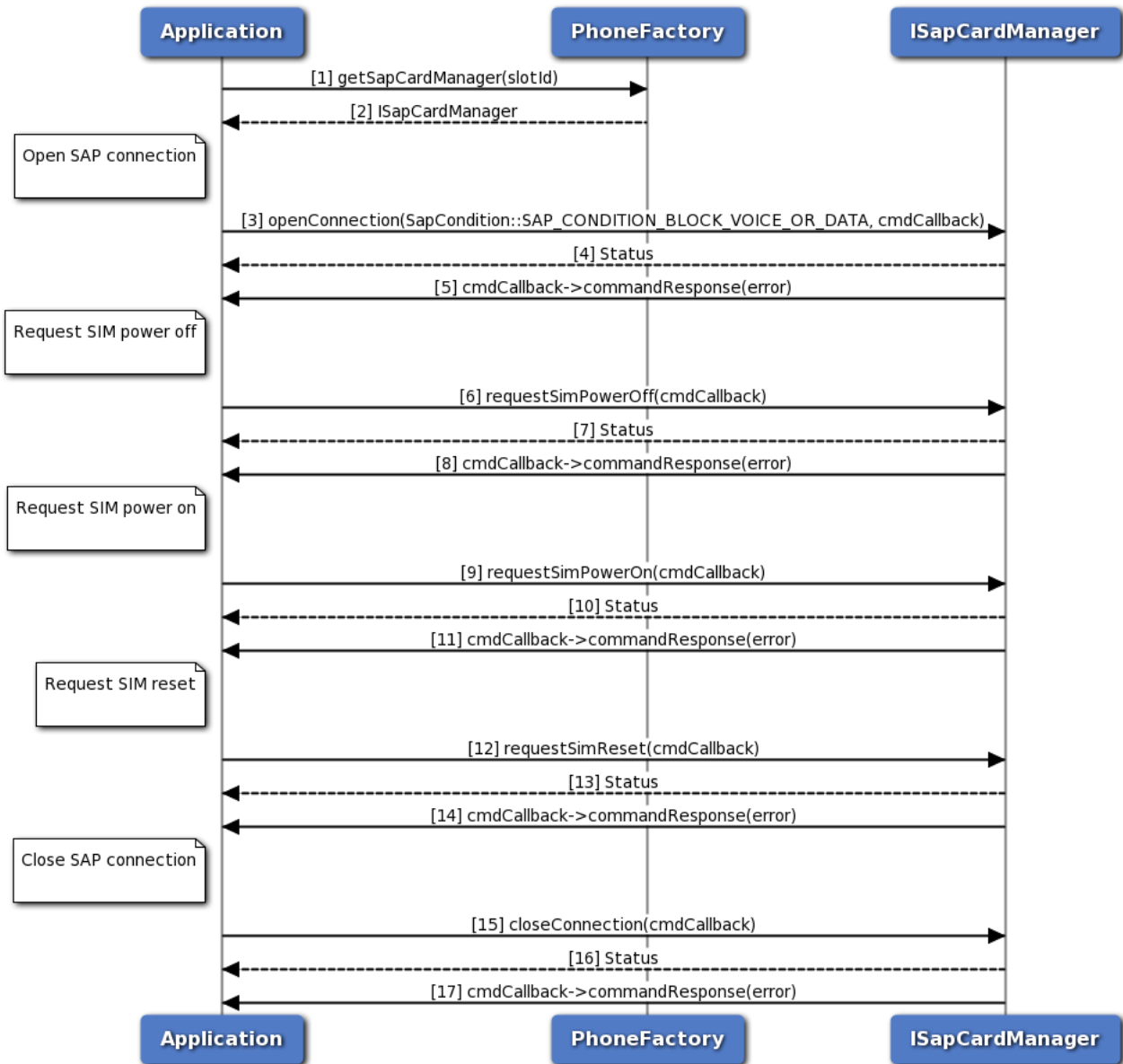

**Figure 3-17 Request card reader status, Request ATR, Transmit APDU call flow**

1. The application gets SapCardManager object corresponding to slotId using PhoneFactory.
2. The application receives the SapCardManager object in order to perform SAP operations like request ATR, Card Reader Status and transmit APDU.
3. The application opens SIM Access Profile(SAP) connection with SIM card using default SAP condition (i.e. SAP\_CONDITION\_BLOCK\_VOICE\_OR\_DATA) and optionally, gets asynchronous response using CommandResponseCallback.
4. The application receives the status i.e. either SUCCESS or FAILED based on execution of openConnection API in SapCardManager.
5. Optionally, the response for openConnection is received by the application.
6. The application sends request card reader status command and optionally, gets asynchronous response using ICardReaderCallback.

7. The application receives the status i.e. either SUCCESS or FAILED based on execution of requestCardReaderStatus API in SapCardManager.
8. Optionally, the response for card reader status is received by the application.
9. Similarly, the application can send SAP Answer To Reset command and optionally, gets asynchronous response using IAtrResponseCallback.
10. The application receives the status i.e. either SUCCESS or FAILED based on execution of requestAtr API in SapCardManager.
11. Optionally, the response for SAP Answer To Reset is received by the application.
12. Similarly, the application sends the APDU on SAP mode and optionally, gets asynchronous response using ISapTransmitApduResponseCallback.
13. The application receives the status i.e. either SUCCESS or FAILED based on execution of transmitApdu API in SapCardManager.
14. Optionally, the response for transmit APDU is received by the application.
15. Now the application closes the SAP connection with SIM and optionally, gets asynchronous response using CommandResponseCallback.
16. The application receives the status i.e. either SUCCESS or FAILED based on execution of closeConnection API in SapCardManager.
17. Optionally, the response for SAP close connection is received by the application.

### 3.2.15.2 SIM Turn off, Turn on and Reset call flow



**Figure 3-18 SIM Turn off, Turn on and Reset call flow**

1. Application gets SapCardManager object corresponding to slotID using PhoneFactory.
2. PhoneFactory returns the SapCardManager object to application in order to perform SAP operations like SIM power off, on or reset.
3. The application opens SIM Access Profile(SAP) connection with SIM card using default SAP condition (i.e. SAP\_CONDITION\_BLOCK\_VOICE\_OR\_DATA) and optionally, gets asynchronous response using CommandResponseCallback.
4. Application receives the status i.e. either SUCCESS or FAILED based on execution of openConnection API in SapCardManager.

5. Optionally, the response for openConnection is received by the application.
6. The application sends SIM Power Off command to turn off the SIM and optionally, gets asynchronous response using CommandResponseCallback.
7. The application receives the status i.e. either SUCCESS or FAILED based on execution of requestSimPowerOff API in SapCardManager.
8. Optionally, the response for SIM Power Off is received by the application.
9. Similarly, the application can send SIM Power On command to turn on the SIM and optionally, gets asynchronous response using CommandResponseCallback.
10. The application receives the status i.e. either SUCCESS or FAILED based on execution of requestSimPowerOn API in SapCardManager.
11. Optionally, the response for SIM Power On is received by the application.
12. Similarly, the application sends SIM Reset command to perform SIM Reset and optionally, gets asynchronous response.
13. The application receives the status i.e. either SUCCESS or FAILED based on execution of requestSimReset API in SapCardManager.
14. Optionally, the response for SIM Reset is received by the application.
15. Now the application closes the SAP connection with SIM and optionally, gets asynchronous response using CommandResponseCallback.
16. The application receives the status i.e. either SUCCESS or FAILED based on execution of closeConnection API in SapCardManager.
17. Optionally, the response for SAP close connection is received by the application.

### 3.2.16 Subscription Call flow

#### 3.2.16.1 Subscription initialization

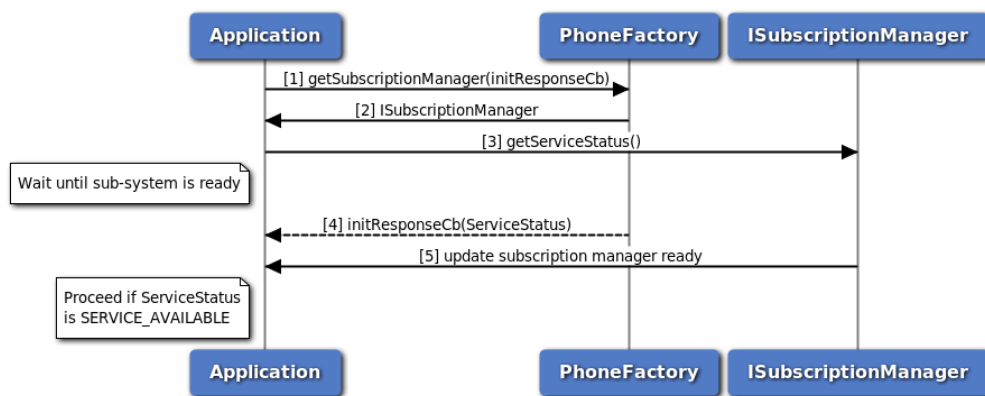

Figure 3-19 Subscription initialization call flow

1. Application requests an instance of SubscriptionManager using PhoneFactory by providing the initialization callback.
2. Application receives a Subscription Manager instance.

3. Application uses SubscriptionManager::getServiceStatus to determine if the Subscription Manager is ready.
4. Application waits for the subsystem initialization callback, which notifies the subsystem initialization status.
5. SubscriptionManager updates the application once subscription manager initialization completes.

### 3.2.16.2 Subscription call flow

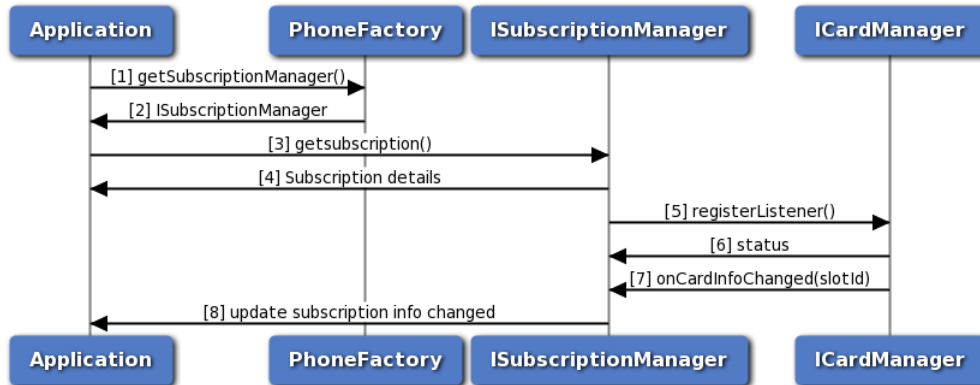

Figure 3-20 Subscription call flow

1. The application gets the PhoneManager object using PhoneFactory.
2. The application receives the PhoneManager object in order to get Subscription.
3. The application gets the Subscription object for given slot identifier using SubscriptionManager.
4. SubscriptionManager returns Subscription object to application. Subscription can be used to get subscription details like countryISO, operator details etc.
5. The Subscription manager registers a listener with CardManager to listen to the card info change notifications like card state PRESENT, ABSENT, UNKNOWN, ERROR and RESTRICTED.
6. The SubscriptionManager receives the status like SUCCESS or INVALIDPARAM based on registration of listener to CardManager.
7. The SubscriptionManager receives callback card info change i.e subscription info changed or removed.
8. The SubscriptionManager updates the application once the subscription info is updated.

### 3.2.17 Remote SIM Provisioning Call Flow

Remote SIM provisioning provides API to add profile, delete profile, activate/deactivate profile on the embedded SIMs (eUICC) , get list of profiles, get server address like SMDP+ and SMDS and update SMDP+ address, update nick name of profile and retrieve Embedded Identity Document(EID) of the SIM.



### 3.2.17.1 Download and deletion of profile call flow

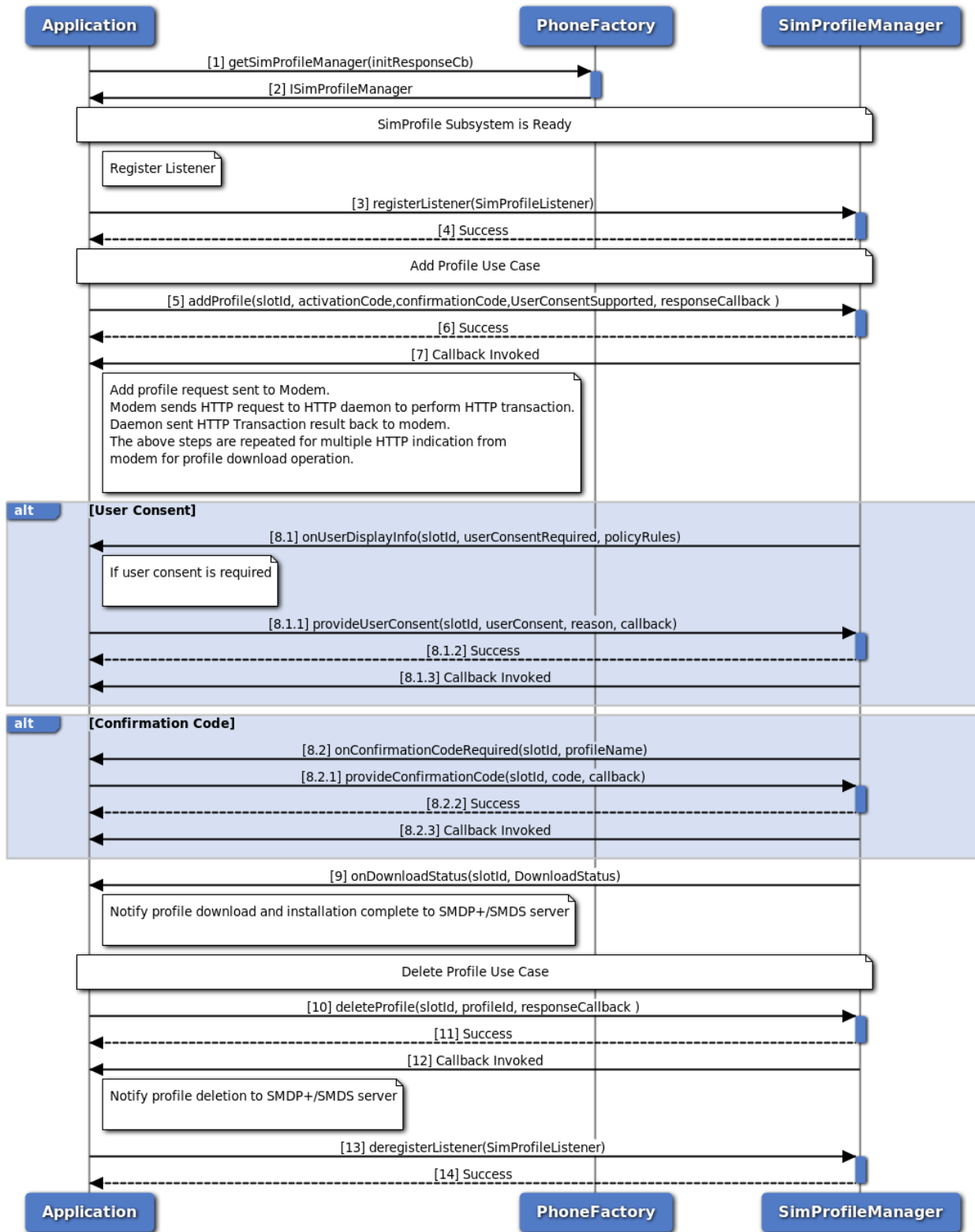

Figure 3-21 Download and deletion of profile call flow

1. Application requests Phonefactory for SimProfileManager object with application callback.
2. Phonefactory returns shared pointer to SimProfileManager object to application using which application performs profile related operations. Wait for subsystem to get ready.
3. If subsystem is ready, create a listener of type ISimProfileListener which would receive notifications about profile download status, user display info and confirmation code is required. Register the created listener with the ISimProfileManager object.
4. Status of register listener i.e. either SUCCESS or FAILED will be returned to the application.
5. Application can send a request to add profile with activation code. The confirmation code can be optional and user consent supported can be specified in order to receive user consent info.
6. Application receives synchronous status which indicates if the add profile request was sent successfully.
7. The response of addProfile request can be received by application in the application-supplied callback. The modem sends indication about the HTTP request in order to download profile to AP and the AP performs HTTP transaction on behalf of modem and sends HTTP request to SMDP+/SMDS server and response of HTTP request from SMDP+/SMDS is sent back to AP and then to modem. The HTTP response contains information related to profile.
8. Optionally, the application receives notification about user consent required and profile policy rules. The application needs to provide the user consent and also reason (if in case consent not provided) in order to proceed with downloading of profile. The application receives the synchronous status which indicates provide user consent sent successfully and response of provide user consent can be received by application in the application-supplied callback. Optionally, the application receives notification about confirmation code required. The application needs to provide the code in order to proceed with downloading of profile. The application receives the synchronous status which indicates confirmation code required sent successfully and response of provide user consent can be received by application in the application-supplied callback.
9. The application receives notification about the download and installation status of profile on the eUICC. When download and installation of profile is completed, notification is also sent to SMDP+/SMDS server.
10. Application can send a delete request associated with profile identifier on SimProfileManager object.
11. Application receives synchronous status which indicates if the delete profile request was sent successfully.
12. The response of delete request can be received by application in the application-supplied callback. Once deletion of profile is completed notification is sent to SMDP+/SMDS server in order to synchronise the profile state on the server.
13. De-register the listener with the ISimProfileManager object.
14. Application receives the status i.e. either SUCCESS or FAILED based on the execution of de-register listener.

### 3.2.17.2 SIM profile management operations call flow

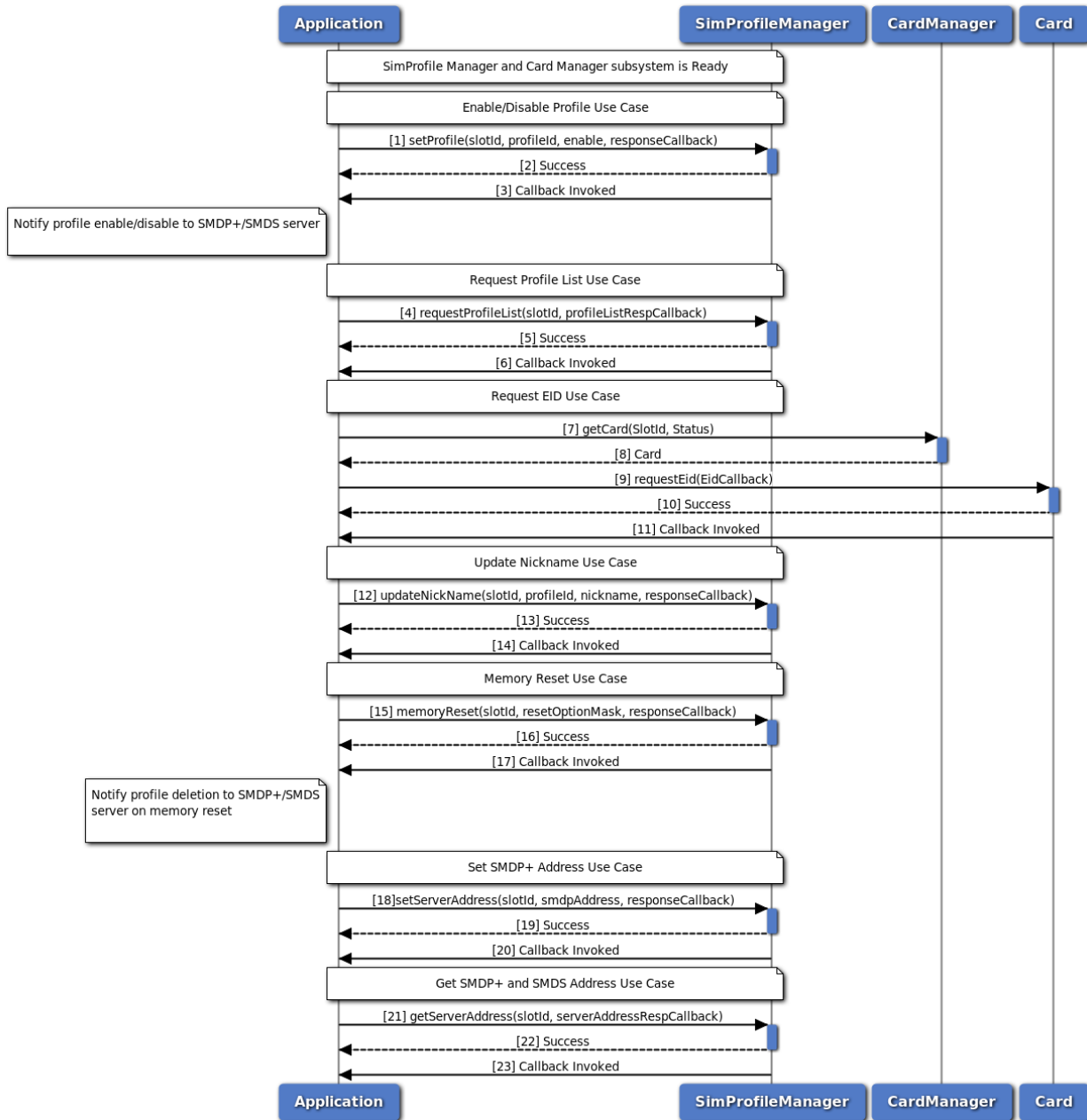

Figure 3-22 SIM profile management operations call flow

The SIM profile sub-system should have been initialized successfully with SERVICE\_AVAILABLE as a pre-requisite for remote SIM provisioning operations and a valid SimProfileManager object is available.

1. Application can send a set profile request associated with profile identifier on SimProfileManager object. This allows to enable or disable the profile on the eUICC.
2. Application receives synchronous status which indicates if the set profile request was sent successfully.

3. The response of set profile request can be received by application in the application-supplied callback. Once enable or disable of profile is completed notification is sent to SMDP+/SMDS server in order to synchronise the profile state on the server.
4. Application can send a get profile list request on SimProfileManager object to retrieve the all available profiles on the eUICC with all profile related details like service provider name(SPN), ICCID etc.
5. Application receives synchronous status which indicates if the get profile list request was sent successfully.
6. The response of get profile list request can be received by application in the application-supplied callback along with all the profile details.
7. Application can get Card object from CardManager associated with the slot.
8. CardManager returns shared pointer to Card object to application using which application can retrieve EID.
9. Application can send a get EID request on Card.
10. Application receives synchronous status which indicates if the get EID request was sent successfully.
11. The response of get EID request can be received by application in the application-supplied callback along with EID details.
12. Application can send update nickname of profile request on SimProfileManager.
13. Application receives synchronous status which indicates if the update nickname request was sent successfully.
14. The response of update nickname request can be received by application in the application supplied callback.
15. Application can send memory reset request on SimProfileManager to delete test or operational profiles or set SMDP address to default.
16. Application receives synchronous status which indicates if the memory reset request was sent successfully.
17. The response of memory reset request can be received by application in the application-supplied callback. Once deletion of profiles happens notification is sent to SMDP+/SMDS to synchronise profile state on the server.
18. Application can send set address name on SimProfileManager in order to set SMDP+ address.
19. Application receives synchronous status which indicates if the set address request was sent successfully.
20. The response of set address request can be received by application in the application-supplied callback.
21. Application can send get address name on SimProfileManager in order to get SMDP+/SMDS address.
22. Application receives synchronous status which indicates if the get address request was sent successfully.
23. The response of get address request can be received by application in the application-supplied callback along with SMDP+/SMDS address.

### 3.2.17.3 HttpTransaction subsystem readiness and handling of indication from modem call flow

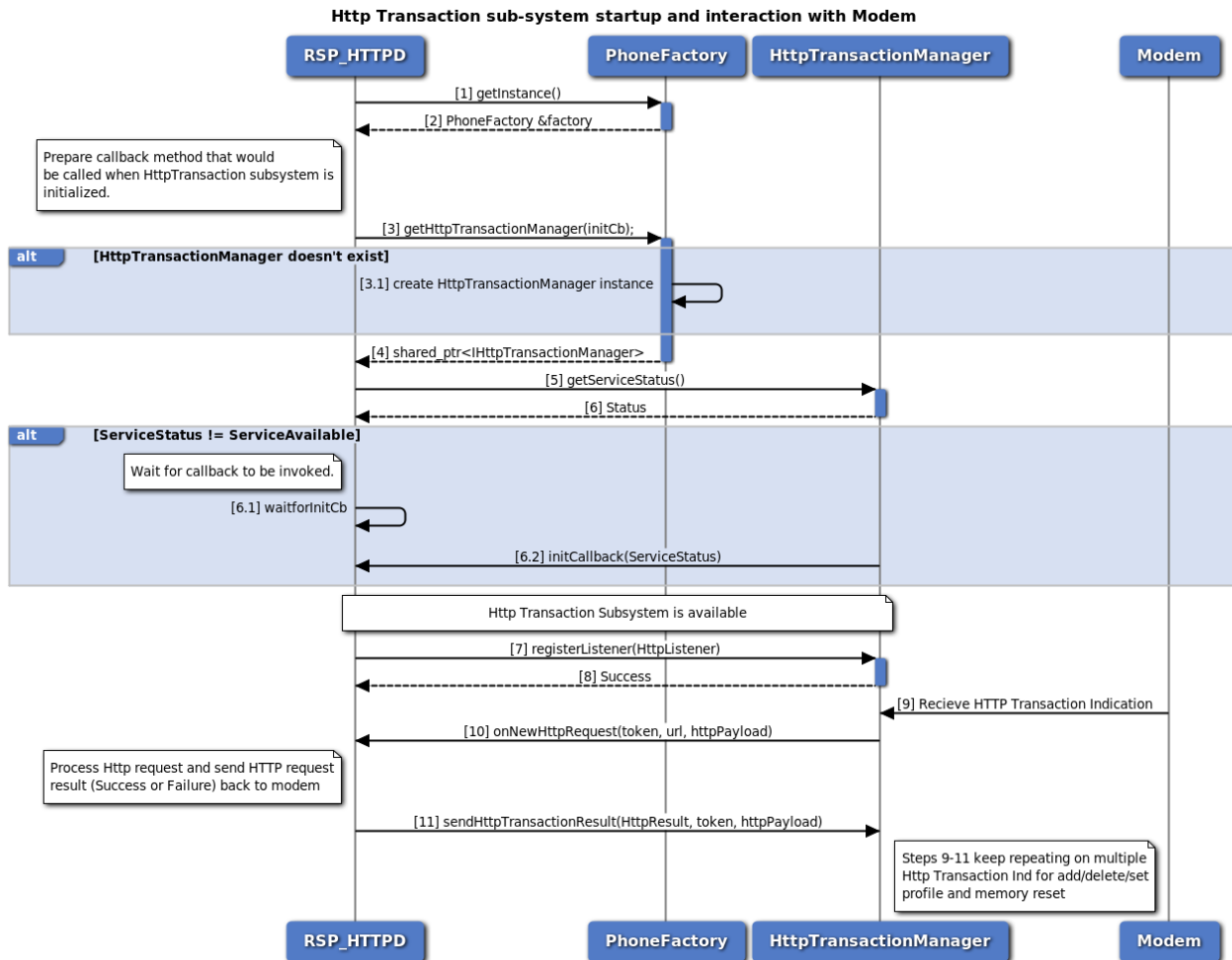

**Figure 3-23 HttpTransaction subsystem readiness and handling of indication from modem call flow**

1. Get the reference to the PhoneFactory, with which we can further acquire other remote SIM provisioning sub-system objects.
2. The reference daemon gets the Phonefactory object.
3. Reference daemon requests Phonefactory for HttpTransactionManager object along with init callback which gets called once initialization is completed.
4. Phonefactory returns shared pointer to HttpTransactionManager object to reference daemon using which reference daemon sends HTTP response to modem and register the listener to listen for HTTP transaction indication. If HttpTransactionManager does not exists then create new object.
5. Wait for subsystem to be ready and get the Service status.
6. The reference daemon check the service status whether service is UNAVAILABLE, AVAILABLE or FAILED. If the service status is not AVAILABLE, then wait for init callback to be called. The subsystem either gets AVAILABLE or FAILED and Service status is recieved in init callback. If the

service status is notified as `SERVICE_FAILED`, retry initialization starting with step (3).

7. If subsystem is `AVAILABLE`, then create a listener of type `IHttpListener` which would receive notifications about HTTP transaction indication. Register the created listener with the `IHttpTransactionManager` object.
8. Status of register listener i.e. either `SUCCESS` or `FAILED` will be returned to the reference daemon.
9. Modem sends the HTTP transaction indication with HTTP request payload and other details to `HTTPTransactionManager`.
10. The reference daemon on AP receives notification about HTTP transaction which process HTTP request.
11. The reference daemon sends HTTP request result (`SUCCESS` or `FAILURE`) with HTTP response back to `HTTPTransactionManager`.
12. Steps (9-11) keep repeating for multiple HTTP Transaction indication for add, delete, set profile and memory reset operations.

### 3.2.18 Remote SIM

Application will get the remote SIM manager object from phone factory. The application must register a listener to receive commands/messages from the modem to send to the SIM. After sending the connection available message, a `onCardConnect()` notification tells the application to connect to the SIM and perform an Answer to Reset. After sending the card reset message (with the AtR bytes), APDU messages will begin

to be sent/received.

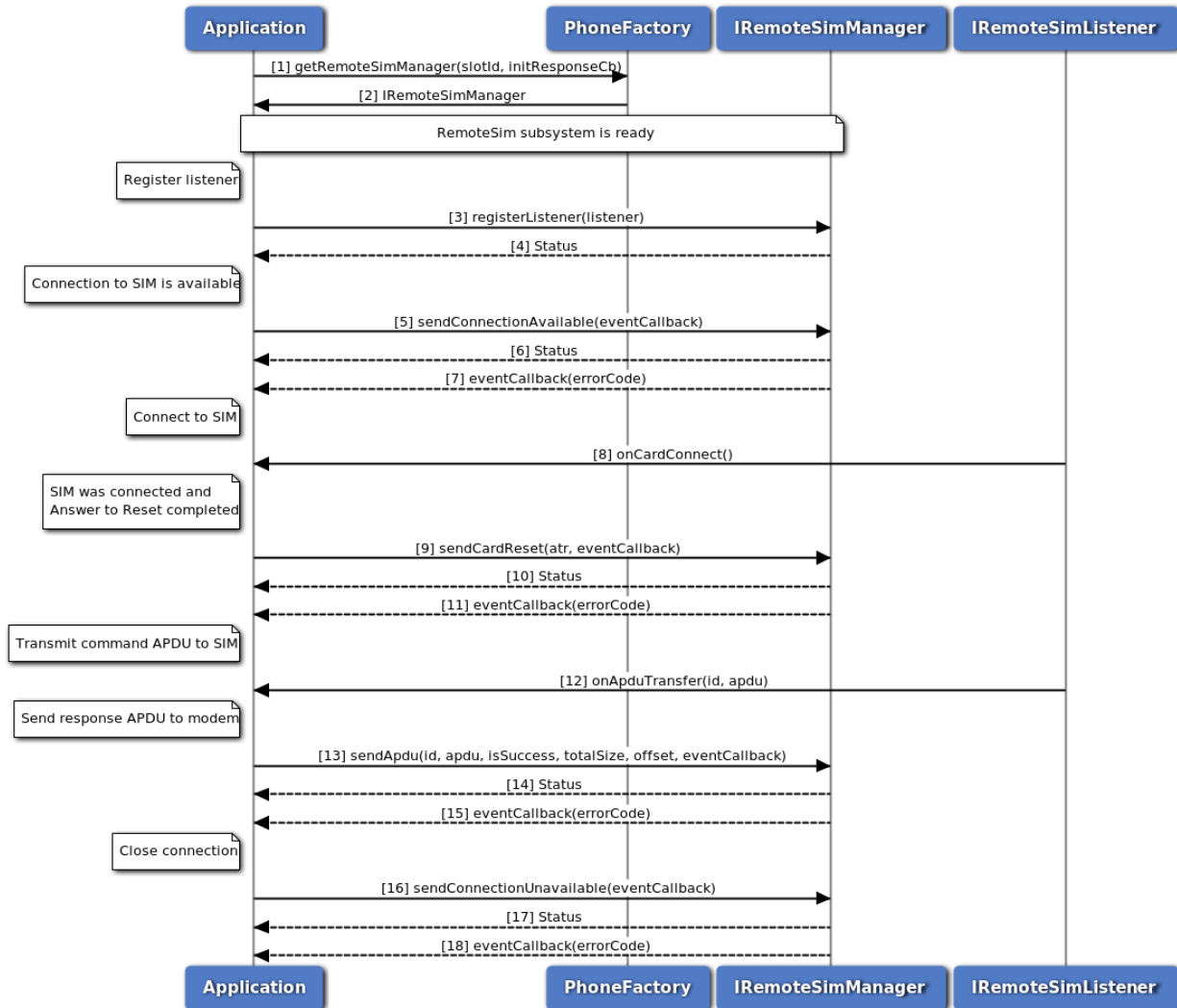

**Figure 3-24 Remote SIM call flow**

1. Application requests remote SIM manager object from phone factory, specifying a slot id and application callback.
2. Phone factory returns IRemoteSimManager object.
3. If subsystem is ready, application registers a listener to receive commands/messages from the modem to send to the SIM.
4. Status of register listener i.e. either SUCCESS or FAILED will be returned to the application.
5. Application sends a connection available message indicating that a SIM is available for use.
6. Status of send connection available i.e. either SUCCESS or FAILED will be returned to the application.
7. Optionally, the response to send connection available request can be received by the application.
8. Application will receive a card connect notification by the listener.

9. After the application successfully connects to the SIM and requests an AtR, it sends a card reset message with the AtR bytes.
10. Status of send card reset i.e. either SUCCESS or FAILED will be returned to the application.
11. Optionally, the response to send card reset request can be received by the application.
12. Application will receive an APDU transfer notification by the listener (with APDU message id).
13. After forwarding the APDU transfer to the SIM and receiving the response, application will send APDU response.
14. Status of send APDU i.e. either SUCCESS or FAILED will be returned to the application.
15. Optionally, the response to send APDU request can be received by the application.
16. To close the connection, application will send connection unavailable message.
17. Status of send connection unavailable i.e. either SUCCESS or FAILED will be returned to the application.
18. Optionally, the response to send connection unavailable can be received by the application.

### 3.3 Location Services

Application will get the location manager object from location factory. The caller needs to register a listener. Application would then need to start the reports using one of 2 APIs depending on if the detailed or basic reports are needed. When reports are no longer required, the app needs to stop the report and de-register the listener.

**NOTE:** Applications need to have "locclient" Linux group permissions to be able to operate successfully with underlying services.



### 3.3.1 Call flow to register/remove listener for generating basic reports

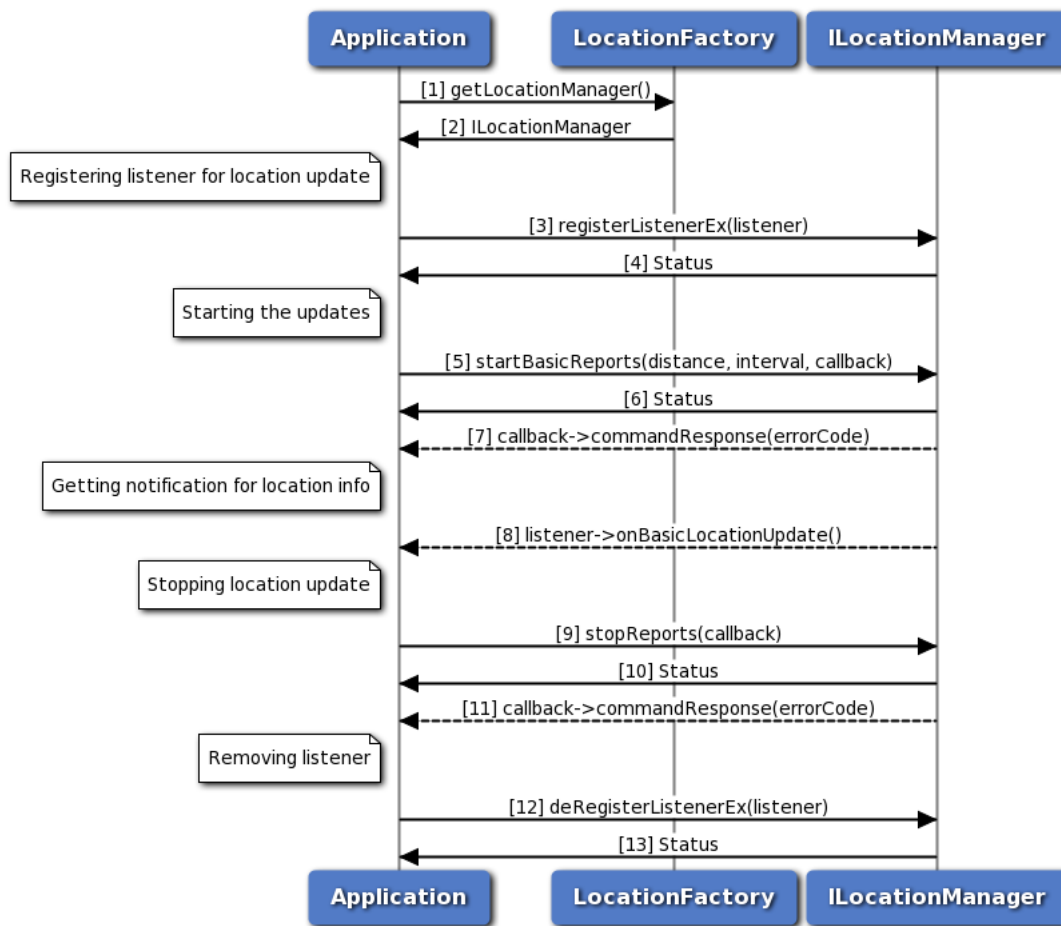

**Figure 3-25 Call flow to register/remove listener for generating basic reports**

1. Application requests location factory for location manager object.
2. Location factory returns ILocationManager object using which application will register or remove a listener.
3. Application can register a listener for getting notifications for location updates.
4. Status of register listener i.e. either SUCCESS or FAILED will be returned to the application.
5. Application starts the basic reports using startBasicReports API for getting location updates.
6. Status of startBasicReports i.e. either SUCCESS or FAILED will be returned to the application.
7. The response for startBasicReports is received by the application.
8. Application will get location updates like latitude, longitude and altitude etc.
9. Application stops receiving the report through stopReports API.
10. Status of stopReports i.e. either SUCCESS or FAILED will be returned to the application.
11. The response for stopReports is received by the application.
12. Application can remove listener and when the number of listeners are zero then location service will

get stopped automatically.

- Status of remove listener i.e. either SUCCESS or FAILED will be returned to the application.

### 3.3.2 Call flow to register/remove listener for generating detailed reports

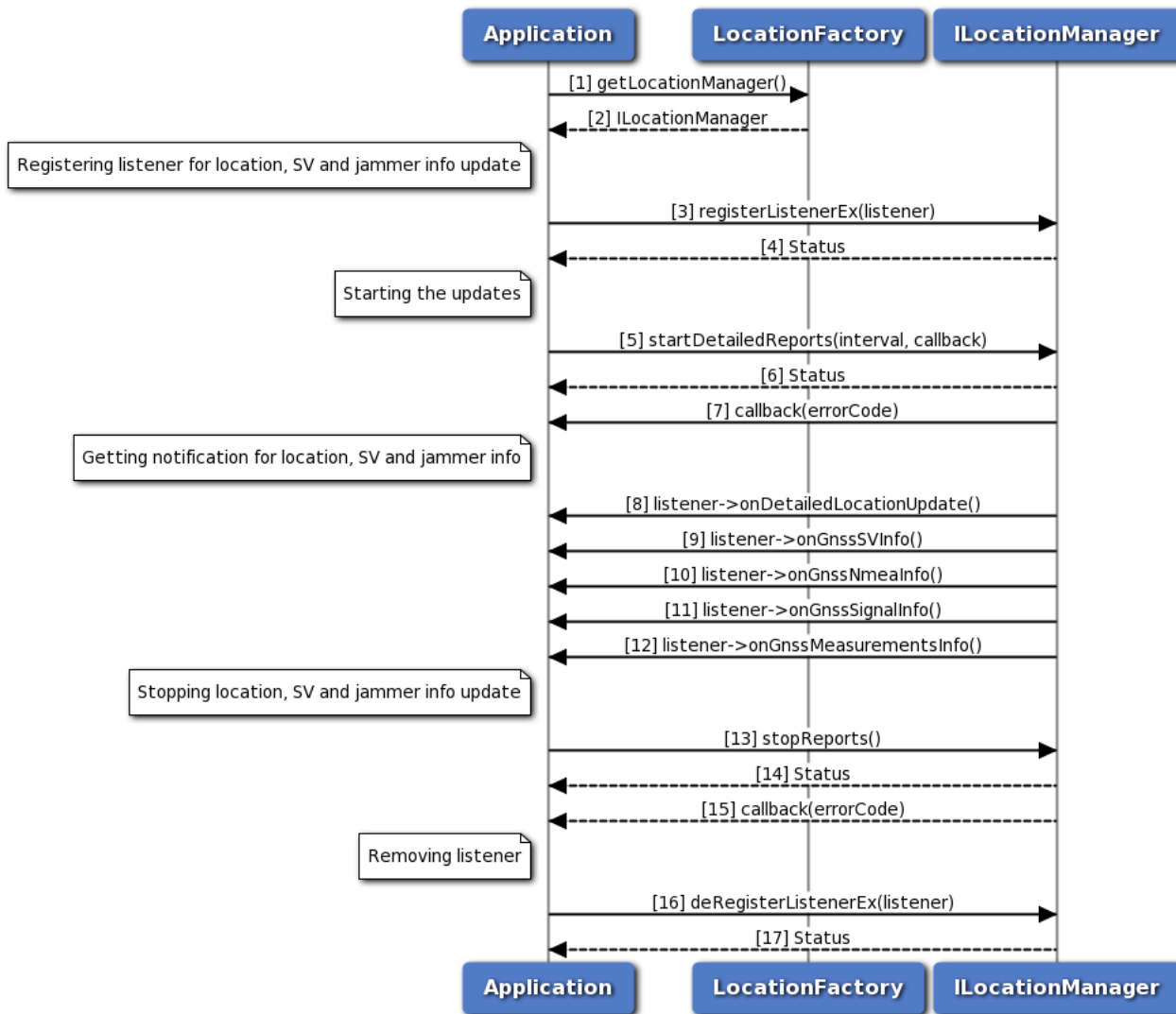
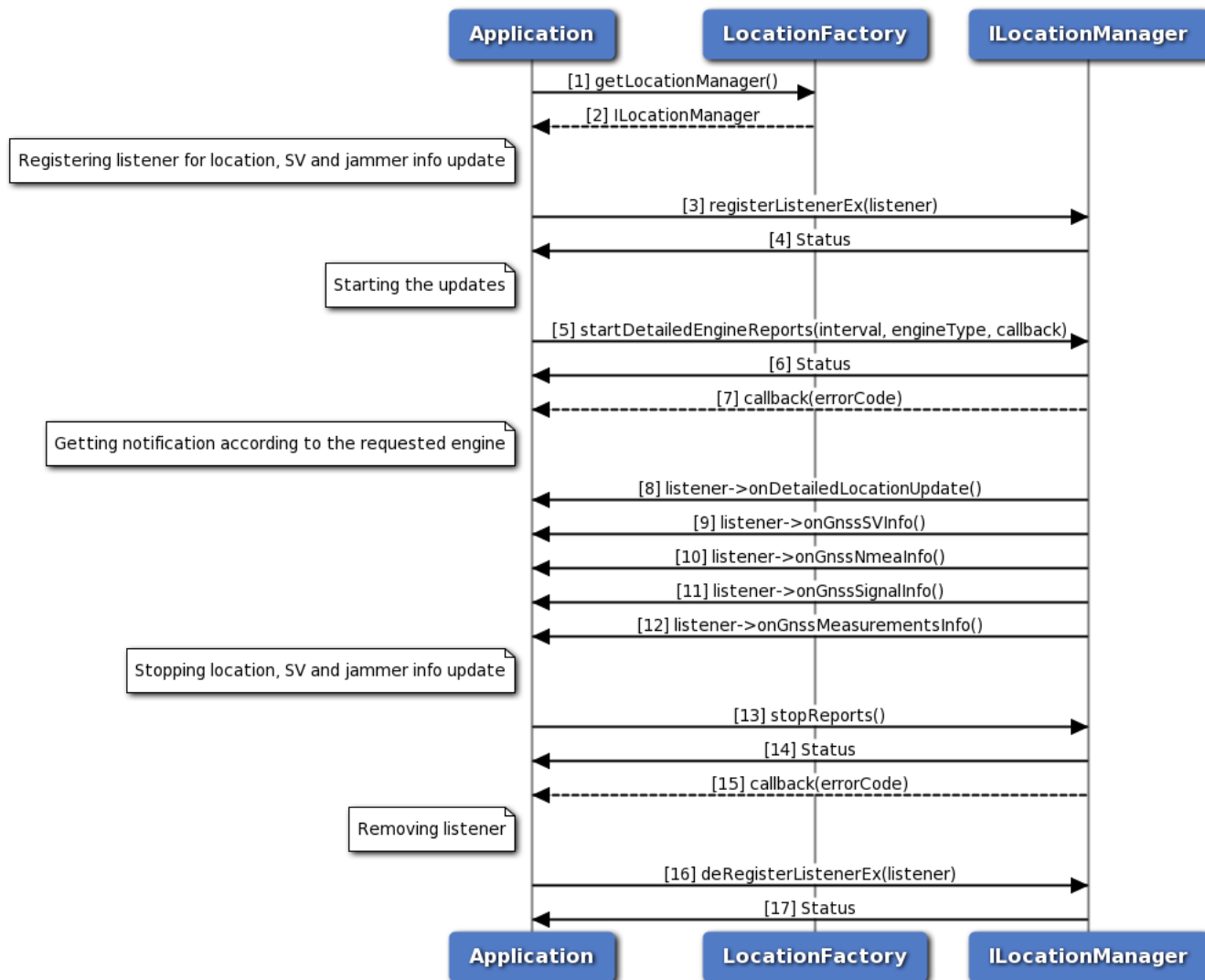

**Figure 3-26 Call flow to register/remove listener for generating detailed reports**

- Application requests location factory for location manager object.
- Location factory returns ILocationManager object using which application will register or remove a listener.
- Application can register a listener for getting notifications for location, satellite vehicle, jammer signal, nmea and measurements updates.
- Status of register listener i.e. either SUCCESS or FAILED will be returned to the application.
- Application starts the detailed reports using startDetailedReports API for getting location, satellite vehicle, jammer signal, nmea and measurements updates.

6. Status of startDetailedReports i.e. either SUCCESS or FAILED will be returned to the application.
7. The response for startDetailedReports is received by the application.
8. Application will get location updates like latitude, longitude and altitude etc.
9. Application will receive satellite vehicle information like SV status and constellation etc.
10. Application will receive nmea information.
11. Application will receive jammer information etc.
12. Application will receive measurement information.
13. Application stops receiving all the reports through stopReports API.
14. Status of stopReports i.e. either SUCCESS or FAILED will be returned to the application.
15. The response for stopReports is received by the application.
16. Application can remove listener and when the number of listeners are zero then location service will get stopped automatically.
17. Status of remove listener i.e. either SUCCESS or FAILED will be returned to the application.

### 3.3.3 Call flow to register/remove listener for generating detailed engine reports



**Figure 3-27 Call flow to register/remove listener for generating detailed engine reports**

1. Application requests location factory for location manager object.
2. Location factory returns ILocationManager object using which application will register or remove a listener.
3. Application can register a listener for getting notifications for location, satellite vehicle and jammer signal, nmea and measurements updates.
4. Status of register listener i.e. either SUCCESS or FAILED will be returned to the application.
5. Application starts the detailed engine reports using startDetailedEngineReports API for getting location, satellite vehicle, jammer signal, nmea and measurements updates.
6. Status of startDetailedReports i.e. either SUCCESS or FAILED will be returned to the application.

7. The response for startDetailedReports is received by the application.
8. Application will get location updates like latitude, longitude and altitude etc from the requested engine type(SPE/PPE/Fused).
9. Application will receive satellite vehicle information like SV status and constellation etc depending on the requested SPE/PPE/Fused engine type.
10. Application will receive nmea information depending on the requested SPE/PPE/Fused engine type
11. Application will receive jammer information etc depending on the requested SPE/PPE/Fused engine type.
12. Application will receive measurement information etc depending on the requested SPE/PPE/Fused engine type.
13. Application stops receiving all the reports through stopReports API.
14. Status of stopReports i.e. either SUCCESS or FAILED will be returned to the application.
15. The response for stopReports is received by the application.
16. Application can remove listener and when the number of listeners are zero then location service will be stopped automatically.
17. Status of remove listener i.e. either SUCCESS or FAILED will be returned to the application.

### 3.3.4 Call flow to register/remove listener for system info updates

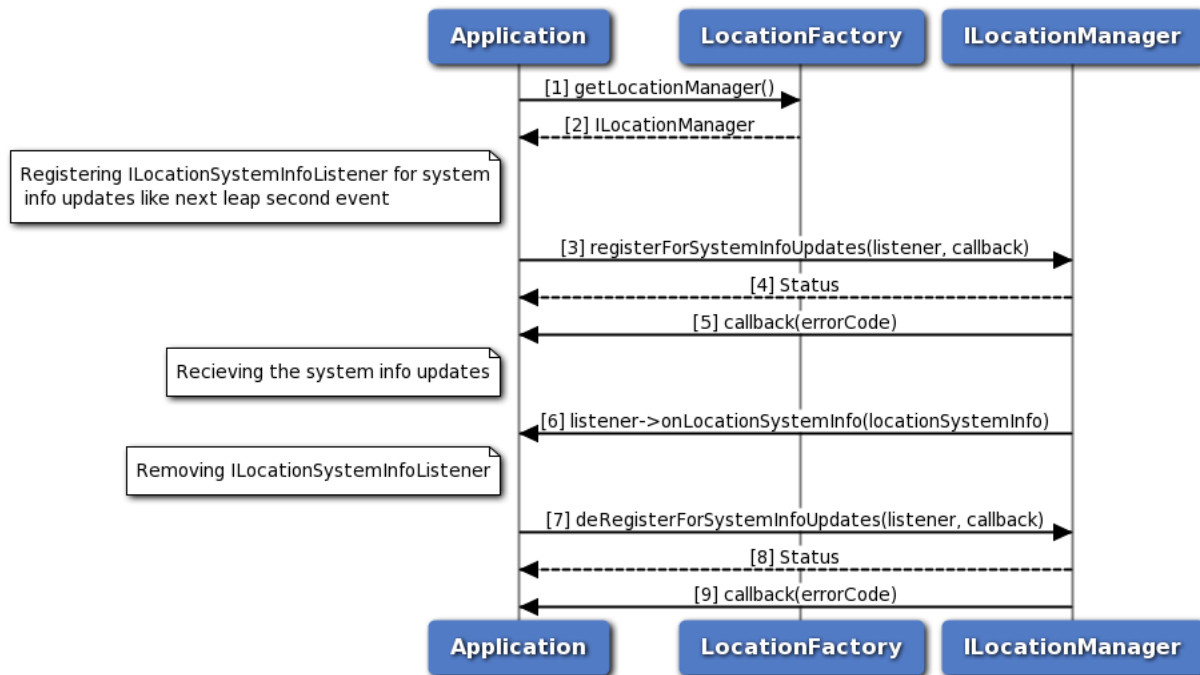
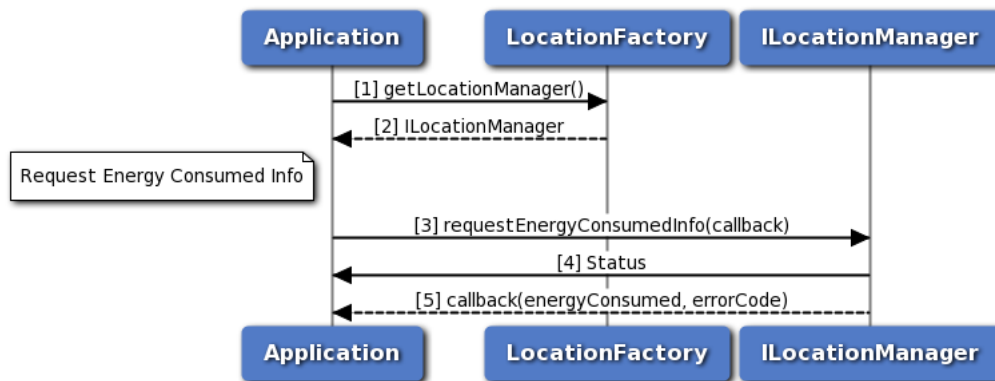

Figure 3-28 Call flow to register/remove listener for system info updates

1. Application requests location factory for location manager object.
2. Location factory returns ILocationManager object using which application will register or remove a listener.

3. Application can register a listener for system information updates with `registerForSystemInfoUpdates`.
4. Status of `registerForSystemInfoUpdates` i.e. either SUCCESS or FAILED will be returned to the application.
5. The response for `registerForSystemInfoUpdates` is received by the application.
6. Application will get system information update.
7. Application can remove listener with `deRegisterForSystemInfoUpdates`.
8. Status of `deRegisterForSystemInfoUpdates` i.e. either SUCCESS or FAILED will be returned to the application.
9. The response for `deRegisterForSystemInfoUpdates` is received by the application.

### 3.3.5 Call flow to request energy consumed information



**Figure 3-29 Call flow to request energy consumed information**

1. Application requests location factory for location manager object.
2. Location factory returns `ILocationManager` object.
3. Application can request for energy consumed information with `requestEnergyConsumedInfo`.
4. Status of `requestEnergyConsumedInfo` i.e. either SUCCESS or FAILED will be returned to the application.
5. The response for `requestEnergyConsumedInfo` is received by the application.

### 3.3.6 Call flow to get year of hardware information

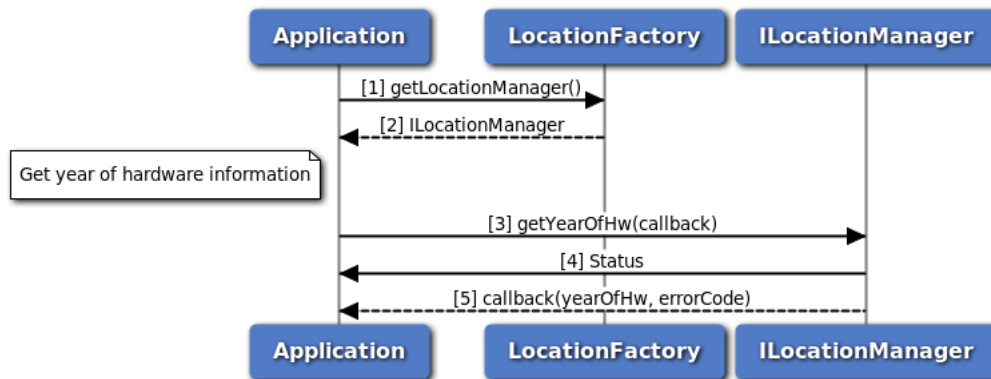

Figure 3-30 Call flow to get year of hardware information

1. Application requests location factory for location manager object.
2. Location factory returns ILocationManager object.
3. Application can request for year of hardware information with getYearOfHw.
4. Status of getYearOfHw i.e. either SUCCESS or FAILED will be returned to the application.
5. The response for getYearOfHw is received by the application.

### 3.3.7 Call flow to get terrestrial positioning information

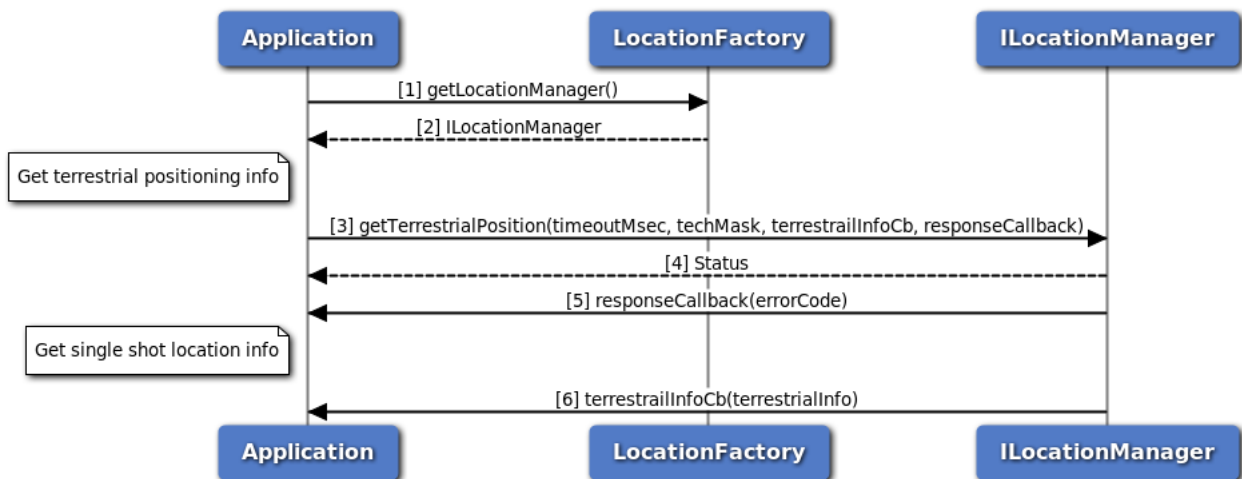

Figure 3-31 Call flow to get terrestrial positioning information

1. Application requests location factory for location manager object.
2. Location factory returns ILocationManager object.
3. Application can request for terrestrial positioning information with getTerrestrialPosition API.

4. Status of `getTerrestrialPosition` i.e. either SUCCESS or FAILED will be returned to the application.
5. The response for `getTerrestrialPosition` is received by the application.
6. Single shot terrestrial position information is received by the application.

### 3.3.8 Call flow to cancel terrestrial positioning information

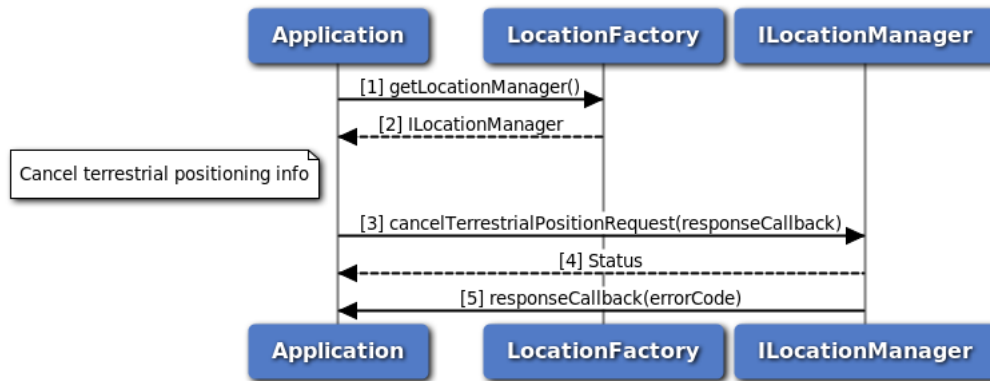

Figure 3-32 Call flow to cancel terrestrial positioning information

1. Application requests location factory for location manager object.
2. Location factory returns ILocationManager object.
3. Application can cancel request for terrestrial positioning information with `cancelTerrestrialPositionRequest` API.
4. Status of `cancelTerrestrialPositionRequest` i.e. either SUCCESS or FAILED will be returned to the application.
5. The response for `cancelTerrestrialPositionRequest` is received by the application.

### 3.3.9 Call flow to enable/disable constraint time uncertainty

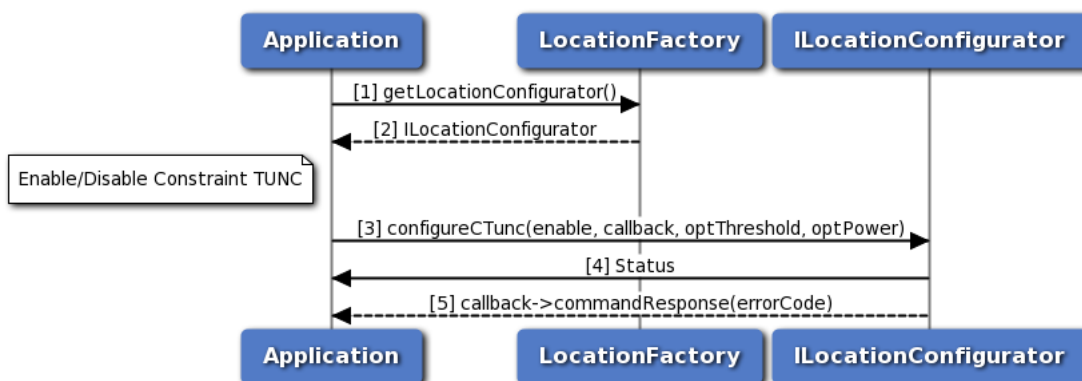

Figure 3-33 Call flow to enable/disable constraint time uncertainty

1. Application requests location factory for location configurator object.



2. Location factory returns ILocationConfigurator object.
3. Application enables/disables constraint tunc using configureCTunc API.
4. Status of configureCTunc i.e. either SUCCESS or FAILED will be returned to the application.
5. The response for configureCTunc is received by the application.

### 3.3.10 Call flow to enable/disable PACE

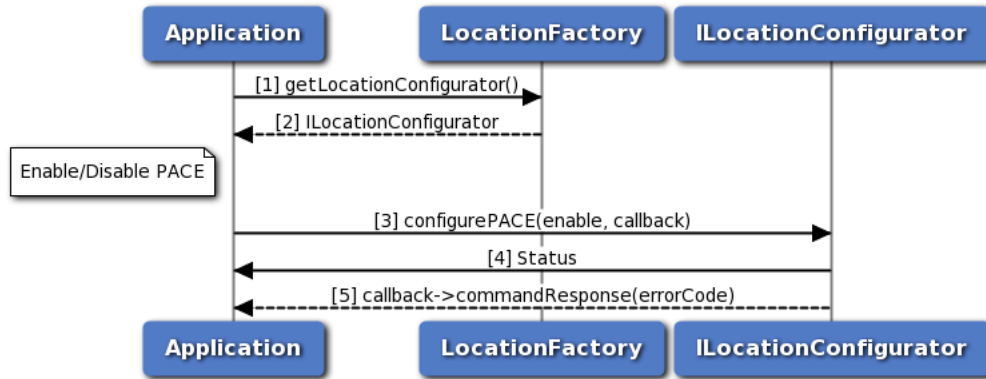

Figure 3-34 Call flow to enable/disable PACE

1. Application requests location factory for location configurator object.
2. Location factory returns ILocationConfigurator object.
3. Application enables/disables PACE using configurePACE API.
4. Status of configurePACE i.e. either SUCCESS or FAILED will be returned to the application.
5. The response for configurePACE is received by the application.

### 3.3.11 Call flow to delete all aiding data

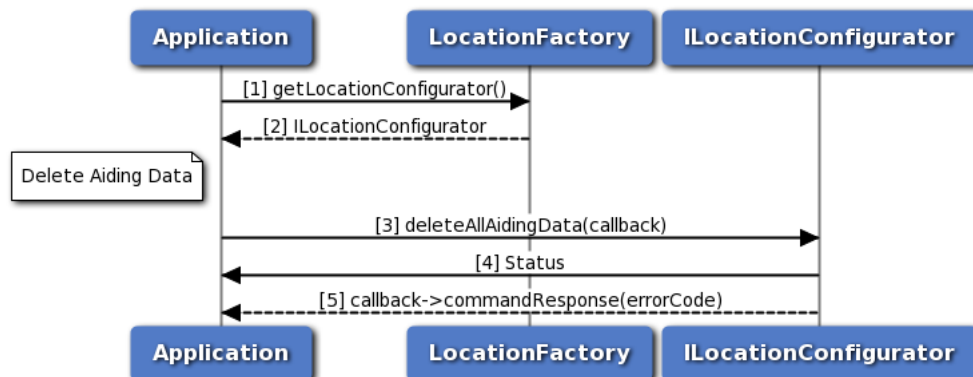

Figure 3-35 Call flow to delete all aiding data

1. Application requests location factory for location configurator object.
2. Location factory returns ILocationConfigurator object.

3. Application deletes all aiding data using deleteAllAidingData API.
4. Status of deleteAllAidingData i.e. either SUCCESS or FAILED will be returned to the application.
5. The response for deleteAllAidingData is received by the application.

### 3.3.12 Call flow to configure lever arm parameters

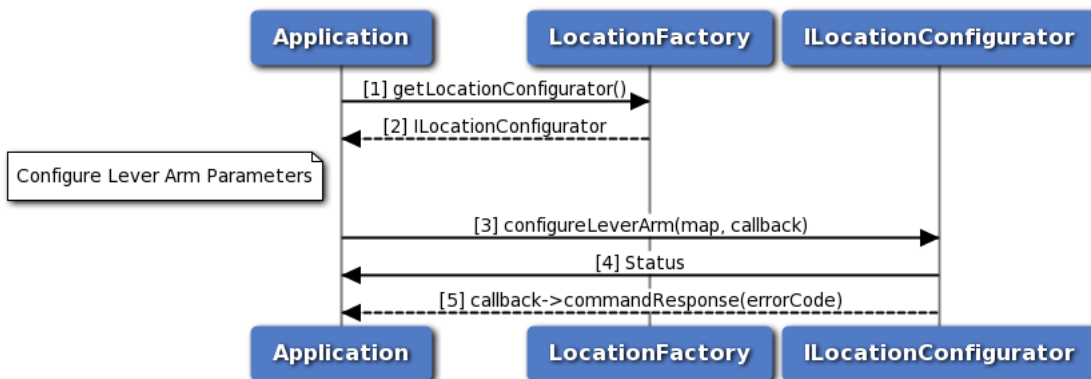

Figure 3-36 Call flow to configure lever arm parameters

1. Application requests location factory for location configurator object.
2. Location factory returns ILocationConfigurator object.
3. Application configures lever arm parameters using configureLeverArm API.
4. Status of configureLeverArm i.e. either SUCCESS or FAILED will be returned to the application.
5. The response for configureLeverArm is received by the application.

### 3.3.13 Call flow to configure blacklisted constellations

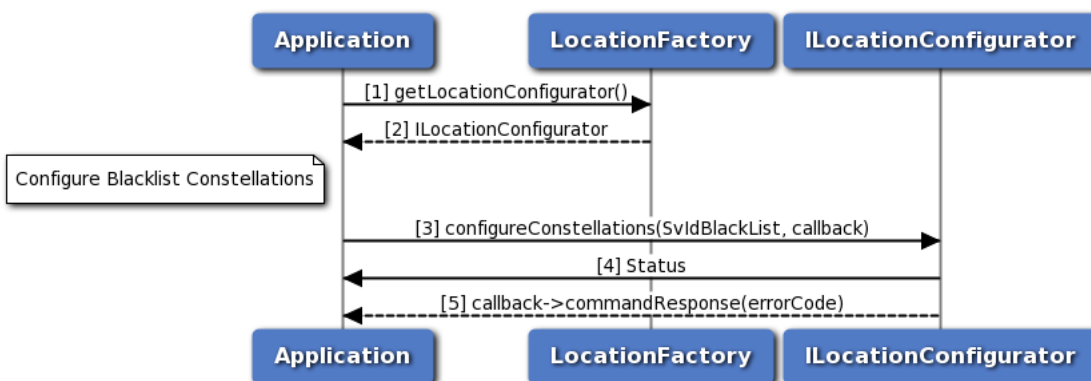

Figure 3-37 Call flow to configure blacklisted constellations

1. Application requests location factory for location configurator object.
2. Location factory returns ILocationConfigurator object.
3. Application configures blacklisted constellations using configureConstellations API.

4. Status of configureConstellations i.e. either SUCCESS or FAILED will be returned to the application.
5. The response for configureConstellations is received by the application.

### 3.3.14 Call flow to configure robust location

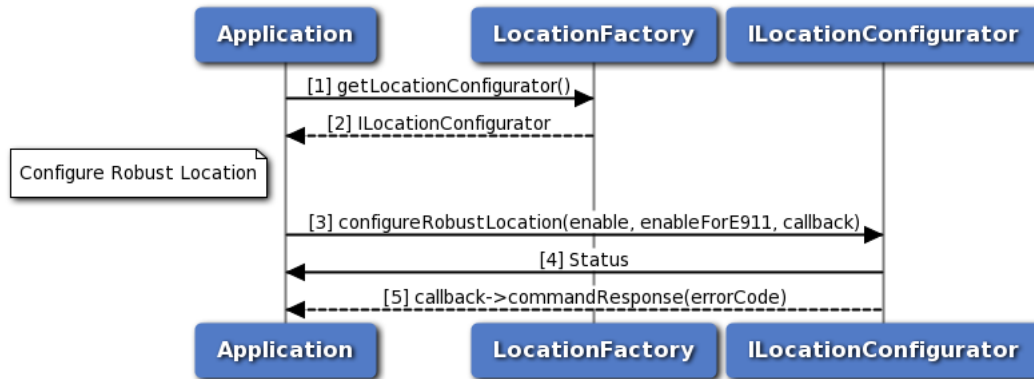

Figure 3-38 Call flow to configure robust location

1. Application requests location factory for location configurator object.
2. Location factory returns ILocationConfigurator object.
3. Application configures robust location using configureRobustLocation API.
4. Status of configureRobustLocation i.e. either SUCCESS or FAILED will be returned to the application.
5. The response for configureRobustLocation is received by the application.

### 3.3.15 Call flow to configure min gps week

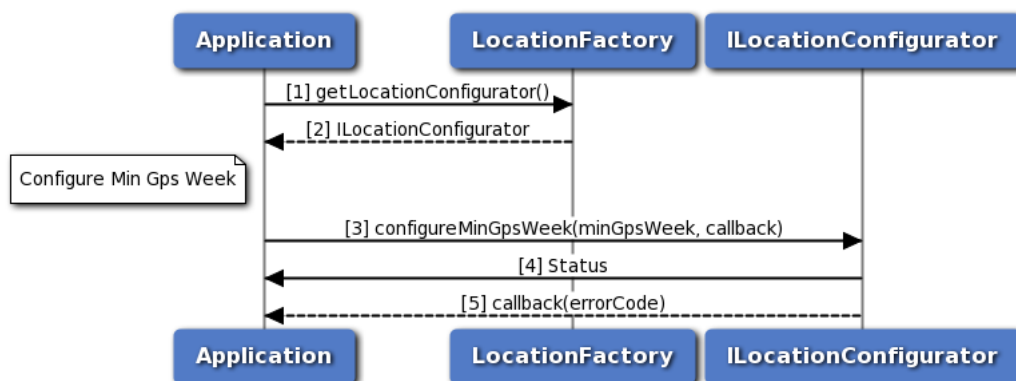

Figure 3-39 Call flow to configure min gps week

1. Application requests location factory for location configurator object.
2. Location factory returns ILocationConfigurator object.
3. Application configures min gps week using configureMinGpsWeek API.

4. Status of configureMinGpsWeek i.e. either SUCCESS or FAILED will be returned to the application.
5. The response for configureMinGpsWeek is received by the application.

### 3.3.16 Call flow to request min gps week

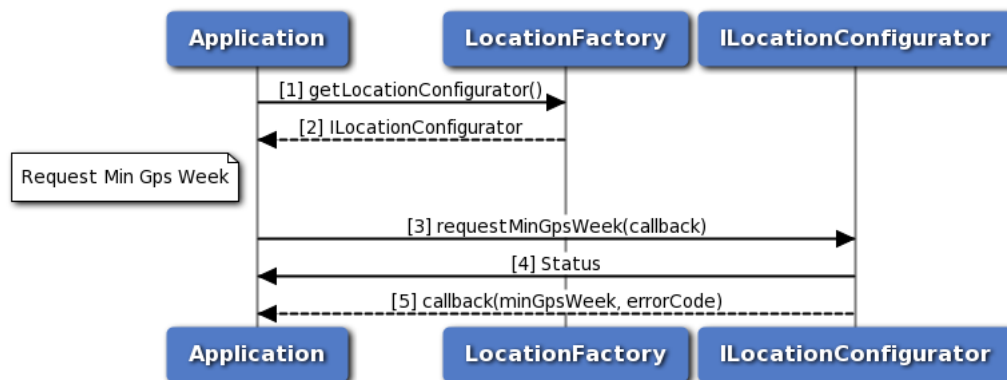

Figure 3-40 Call flow to request min gps week

1. Application requests location factory for location configurator object.
2. Location factory returns ILocationConfigurator object.
3. Application requests min gps week using requestMinGpsWeek API.
4. Status of requestMinGpsWeek i.e. either SUCCESS or FAILED will be returned to the application.
5. The response for requestMinGpsWeek is received by the application.

### 3.3.17 Call flow to delete specified data

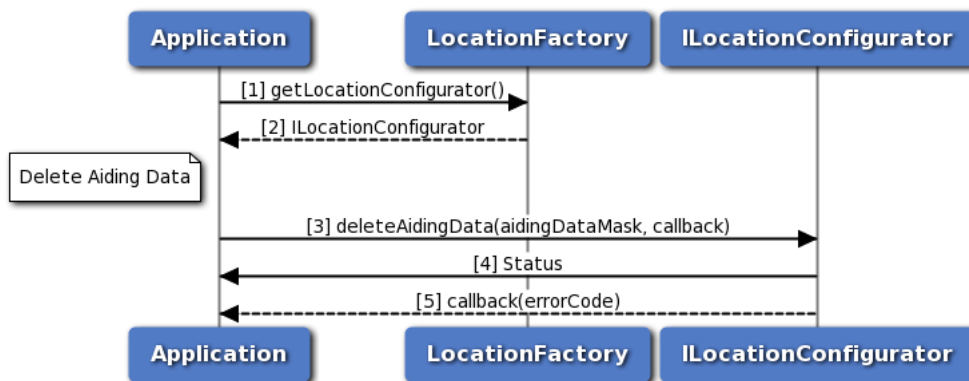

Figure 3-41 Call flow to delete specified data

1. Application requests location factory for location configurator object.
2. Location factory returns ILocationConfigurator object.
3. Application requests delete specified data using deleteAidingData API.
4. Status of deleteAidingData i.e. either SUCCESS or FAILED will be returned to the application.

- The response for deleteAidingData is received by the application.

### 3.3.18 Call flow to configure min sv elevation

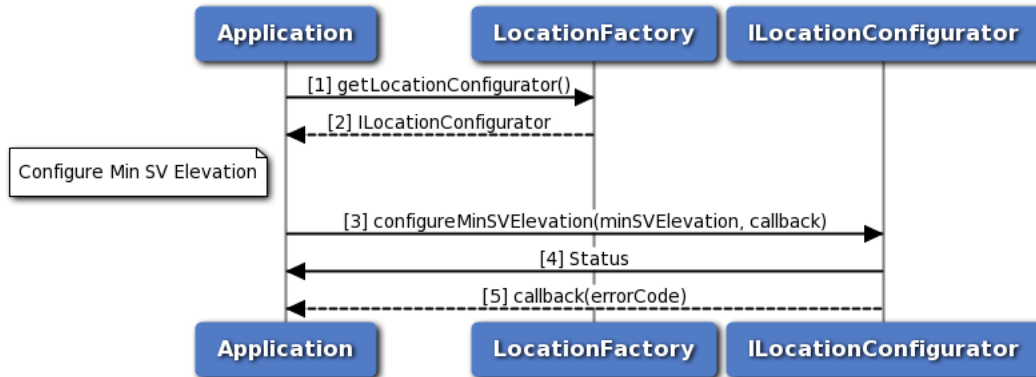

Figure 3-42 Call flow to configure min sv elevation

- Application requests location factory for location configurator object.
- Location factory returns ILocationConfigurator object.
- Application configures min SV elevation using configureMinSVElevation API.
- Status of configureMinSVElevation i.e. either SUCCESS or FAILED will be returned to the application.
- The response for configureMinSVElevation is received by the application.

### 3.3.19 Call flow to request min sv elevation

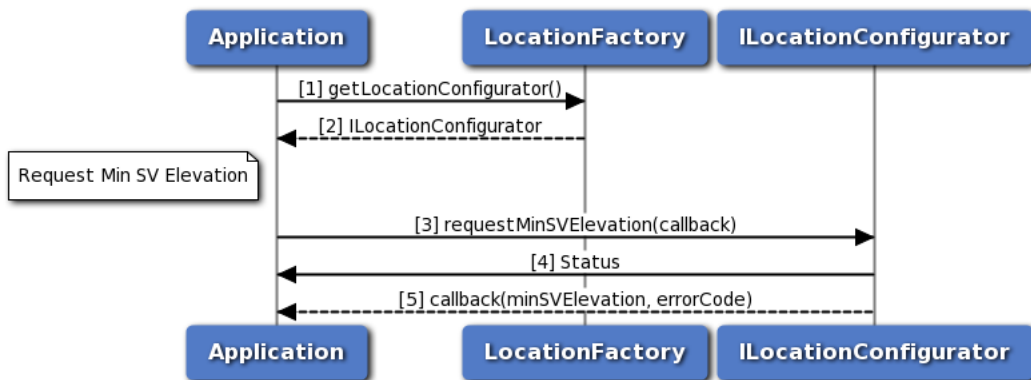

Figure 3-43 Call flow to request min sv elevation

- Application requests location factory for location configurator object.
- Location factory returns ILocationConfigurator object.
- Application requests min SV elevation using requestMinSVElevation API.

4. Status of requestMinSVElevation i.e. either SUCCESS or FAILED will be returned to the application.
5. The response for requestMinSVElevation is received by the application.

### 3.3.20 Call flow to request robust location

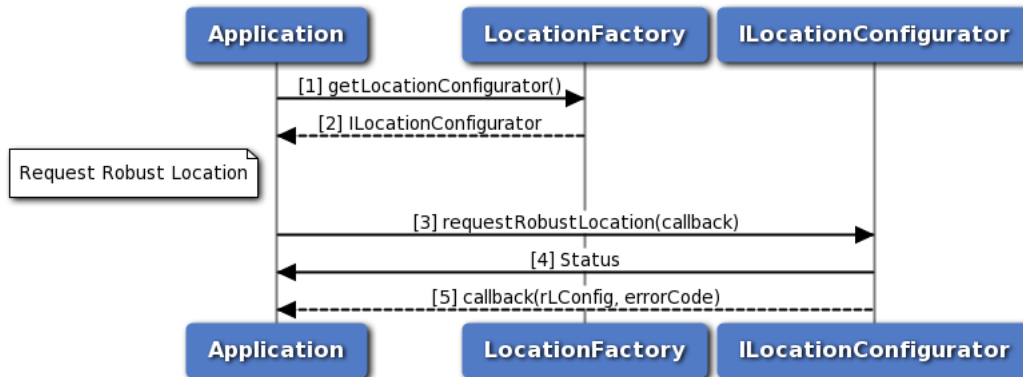

Figure 3-44 Call flow to request robust location

1. Application requests location factory for location configurator object.
2. Location factory returns ILocationConfigurator object.
3. Application requests robust location using requestRobustLocation API.
4. Status of requestRobustLocation i.e. either SUCCESS or FAILED will be returned to the application.
5. The response for requestRobustLocation is received by the application.

### 3.3.21 Call flow to configure dead reckoning engine

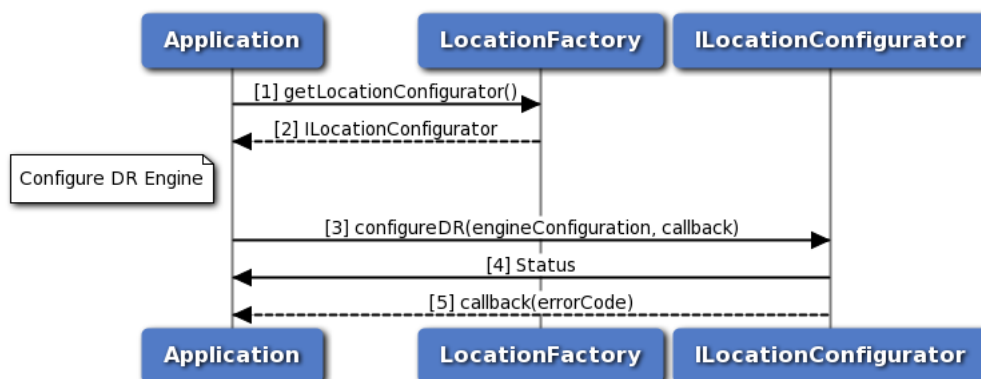

Figure 3-45 Call flow to configure dead reckoning engine

1. Application requests location factory for location configurator object.
2. Location factory returns ILocationConfigurator object.
3. Application configures dead reckoning engine using configureDR API.

4. Status of configureDR i.e. either SUCCESS or FAILED will be returned to the application.
5. The response for configureDR is received by the application.

### 3.3.22 Call flow to configure secondary band

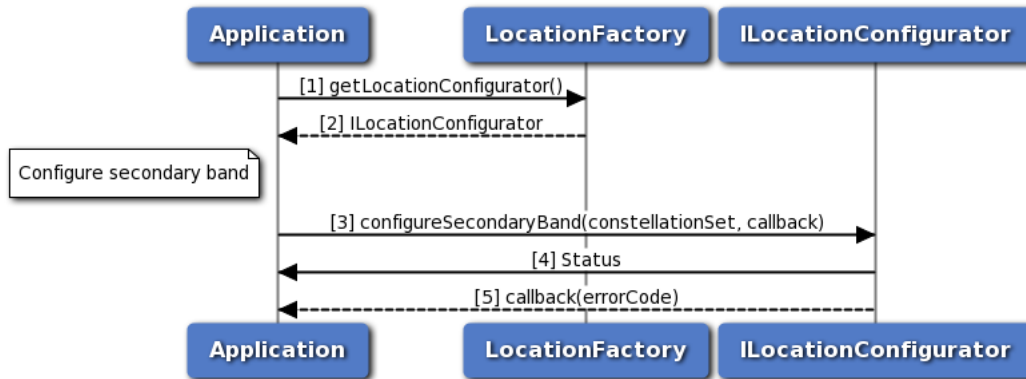

Figure 3-46 Call flow to configure secondary band

1. Application requests location factory for location configurator object.
2. Location factory returns ILocationConfigurator object.
3. Application configures secondary band using configureSecondaryBand API.
4. Status of configureSecondaryBand i.e. either SUCCESS or FAILED will be returned to the application.
5. The response for configureSecondaryBand is received by the application.

### 3.3.23 Call flow to request secondary band

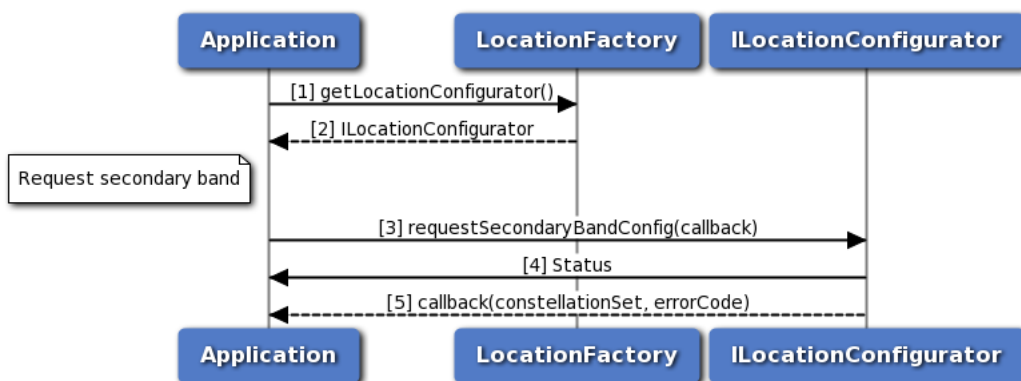

Figure 3-47 Call flow to request secondary band

1. Application requests location factory for location configurator object.
2. Location factory returns ILocationConfigurator object.
3. Application requests secondary band using requestSecondaryBandConfig API.

4. Status of requestSecondaryBandConfig i.e. either SUCCESS or FAILED will be returned to the application.
5. The response for requestSecondaryBandConfig is received by the application.

### 3.3.24 Call flow to configure engine state

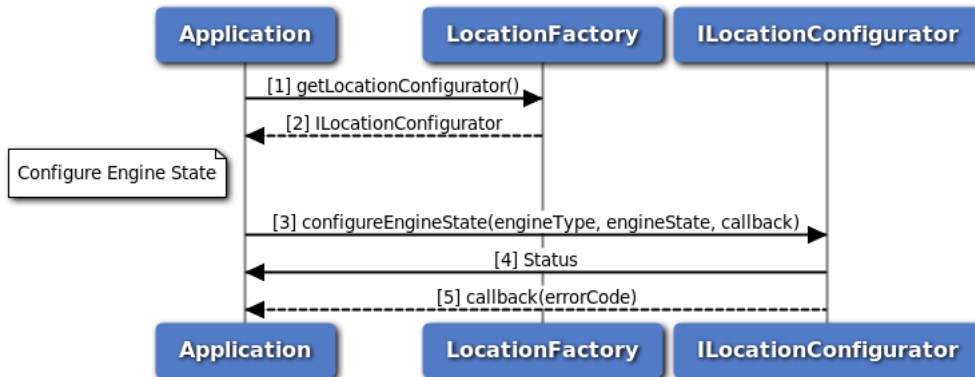

Figure 3-48 Call flow to configure engine state

1. Application requests location factory for location configurator object.
2. Location factory returns ILocationConfigurator object.
3. Application configures engine state using configureEngineState API.
4. Status of configureEngineState i.e. either SUCCESS or FAILED will be returned to the application.
5. The response for configureEngineState is received by the application.

### 3.3.25 Call flow to provide user consent for terrestrial positioning

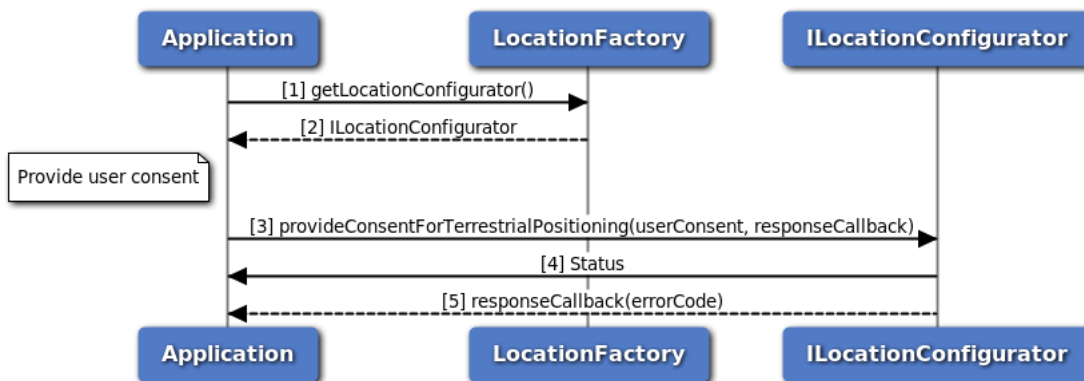

Figure 3-49 Call flow to provide user consent for terrestrial positioning

1. Application requests location factory for location configurator object.
2. Location factory returns ILocationConfigurator object.



3. Application provides user consent for terrestrial positioning using provideConsentForTerrestrialPositioning API.
4. Status of provideConsentForTerrestrialPositioning i.e. either SUCCESS or FAILED will be returned to the application.
5. The response for provideConsentForTerrestrialPositioning is received by the application.

### 3.3.26 Call flow to configure NMEA sentence type

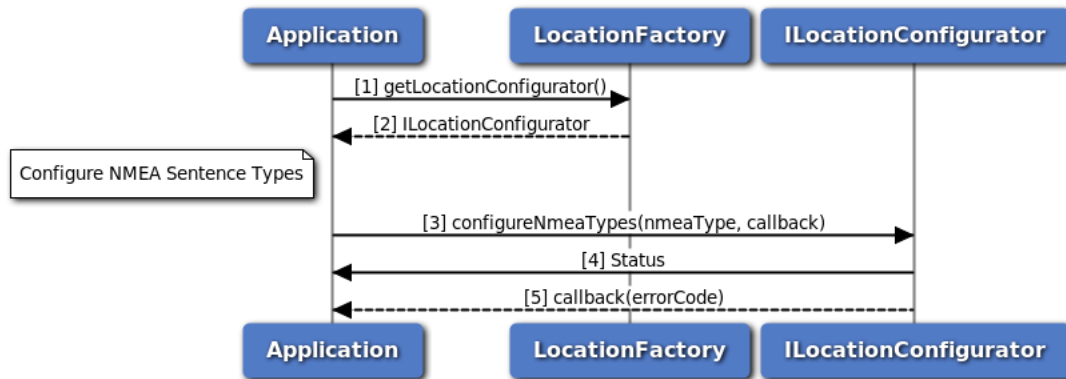

**Figure 3-50 Call flow to configure NMEA sentence type**

1. Application requests location factory for location configurator object.
2. Location factory returns ILocationConfigurator object.
3. Application configures NMEA sentence type using configureNmeaTypes API.
4. Status of configureNmeaTypes i.e. either SUCCESS or FAILED will be returned to the application.
5. The response for configureNmeaTypes is received by the application.

### 3.3.27 Call flow to represent Xtra Feature

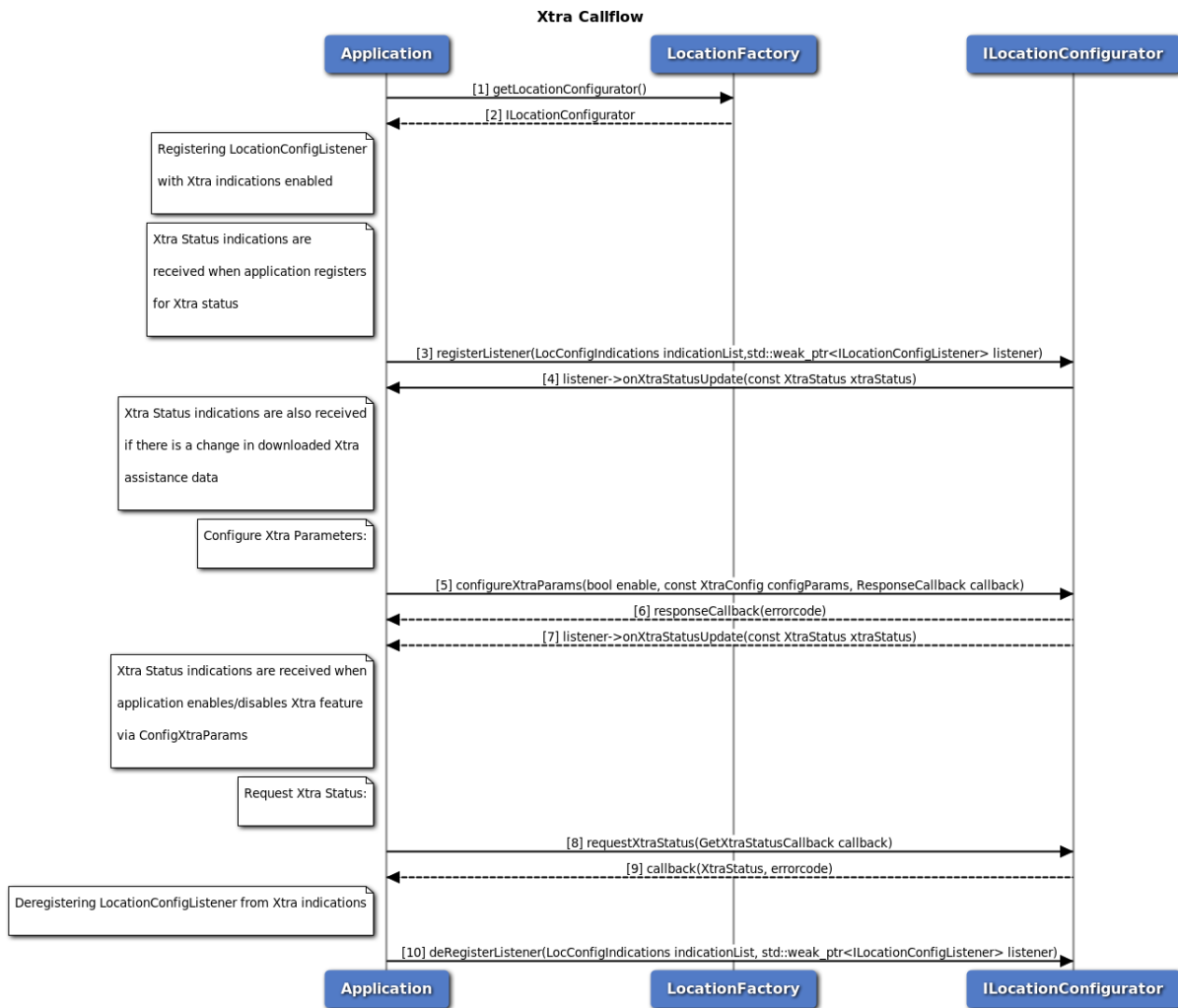

**Figure 3-51 Call flow to represent Xtra Feature**

1. Application requests location factory for location configurator object.
2. Location factory returns ILocationConfigurator object.
3. Application registers config listener for Xtra Status indications.
4. Listener API onXtraStatusUpdate is invoked while registering for Xtra indications.
5. Application configures Xtra Params using configureXtraParams.
6. Location Configurator invokes response callback with errorcode.
7. Listener API onXtraStatusUpdate is invoked when Xtra feature is enabled/disabled.
8. Application requests Xtra Status using requestXtraStatus.
9. Location Configurator invokes GetXtraStatus callback with XtraStatus and errorcode.
10. Application deregisters config listener from Xtra Status indications.

### 3.3.28 Call flow to inject RTCM correction data with dgns manager

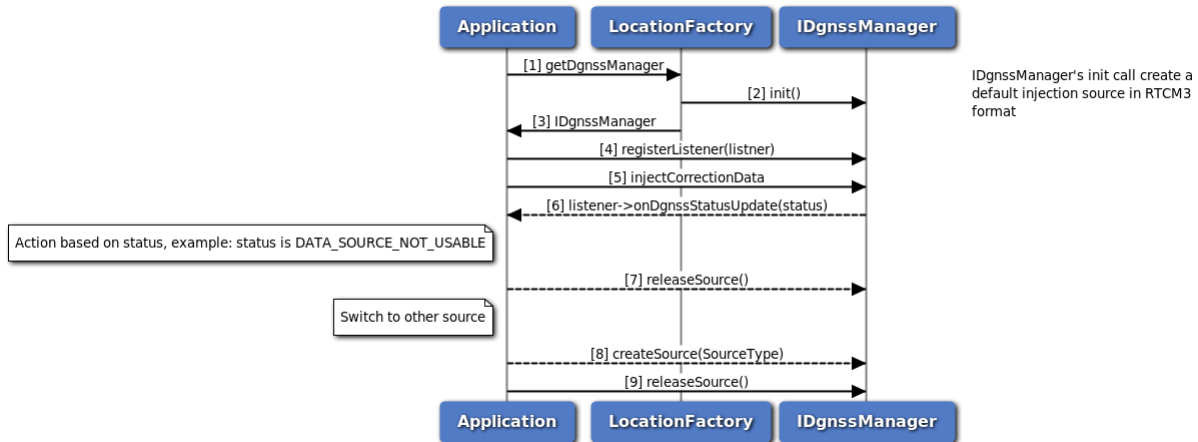

Figure 3-52 Call flow to inject RTCM correction data with dgns manager

1. Application requests location factory for Dgnss manager object.
2. Location factory create IDgnssManager instance and perform initialization.
3. Location factory returns IDgnssManager object.
4. Application register a status listener to get notification of the dgns manager status change.
5. Application start injecting RTCM data.
6. If the status listener received any error notification, it perform desired operation.
7. An example case is the listener received DATA\_SOURCE\_NOT\_USABLE notification, it then release the current source and create a new source and perform RTCM data injection.

## 3.4 Data Services

Applications need to have "radio" Linux group permissions to be able to operate successfully with underlying services.

### 3.4.1 Start/Stop for data connection manager call flow

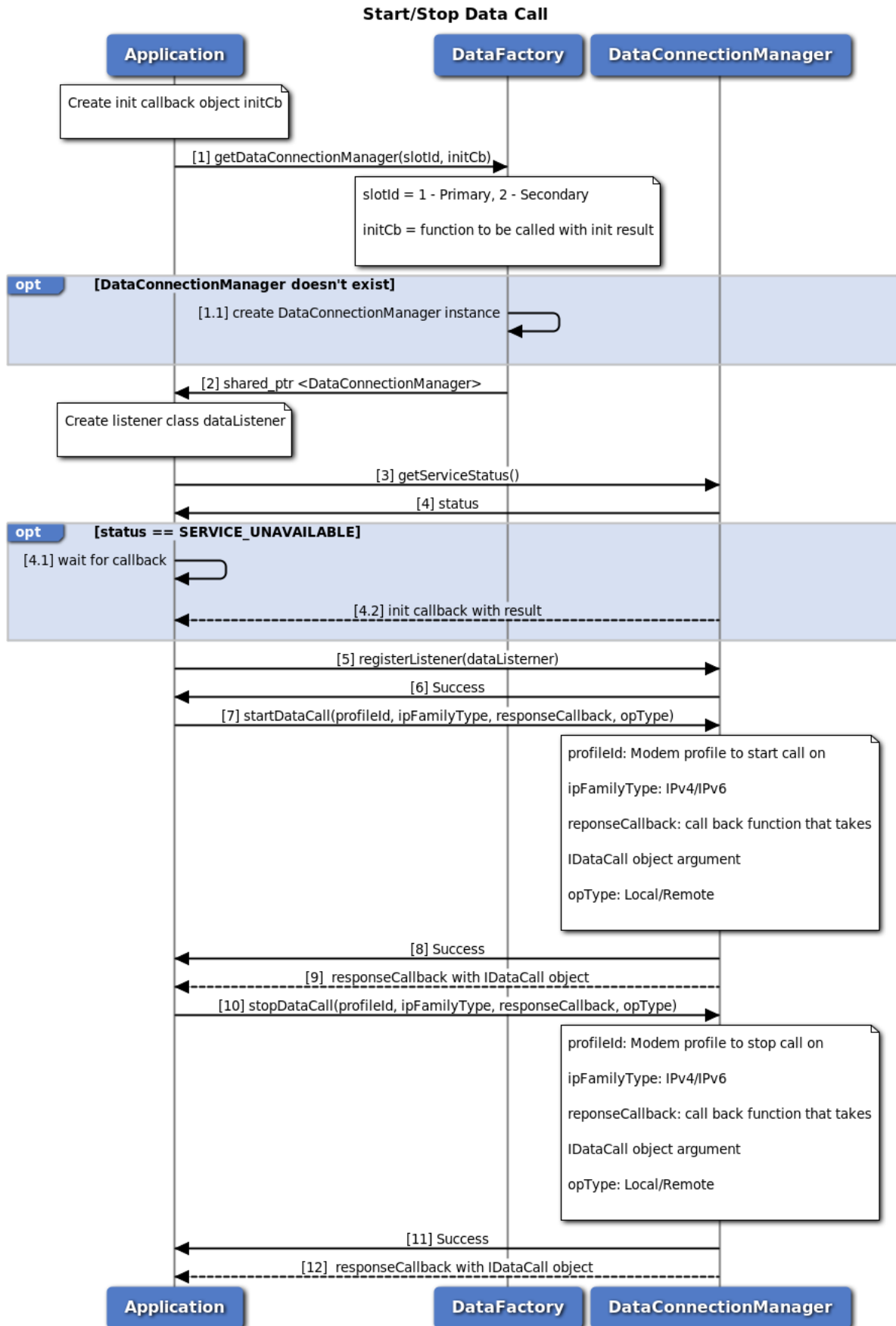

1. Application requests Data Connection Manager object associated with sim id from data factory. Application can optionally provide callback to be called when manager initialization is completed.
2. Data factory returns shared pointer to data connection manager object to application.
3. Application request current service status of data connection manager returned by data factory.
4. Data connection manager returns current service status. 4.1 If status returned is SERVICE\_UNAVAILABLE (manager is not ready), application should wait for init callback provided in step 1. 4.2 Data connection manager calls application callback with initialization result (success/failure).
5. Application registers as listener to get notifications for data call change.
6. The application receives the status i.e. either SUCCESS or FAILED based on the registration of the listener.
7. Application requests for start data call and optionally gets asynchronous response using startDataCallback.
8. Application receives the status i.e. either SUCCESS or FAILED based on the execution of startDataCall.
9. Optionally, the application gets asynchronous response for startDataCall using startDataCallback.
10. Application requests for stop data call and optionally gets asynchronous response using stopDataCallback.
11. Application receives the status i.e. either SUCCESS or FAILED based on the execution of stopDataCall.
12. Optionally, the application gets asynchronous response for stopDataCall using stopDataCallback.

### 3.4.2 Request data profile list call flow

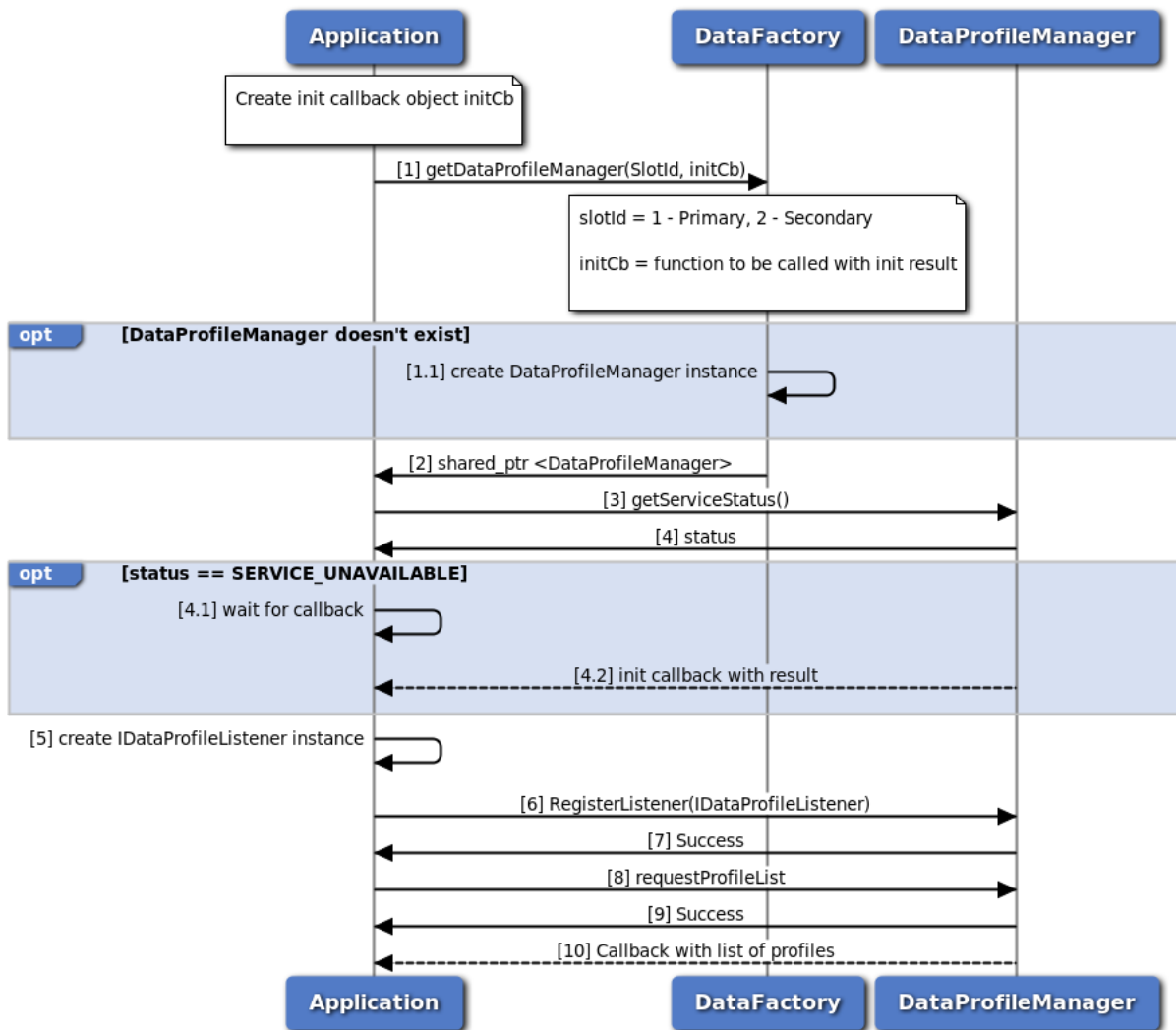

Figure 3-54 Request data profile list call flow

1. Application requests Data profile Manager object associated with sim id from data factory. Application can optionally provide callback to be called when manager initialization is completed.
2. Data factory returns shared pointer to data profile manager object to application.
3. Application request current service status of data profile manager returned by data factory.
4. Data profile manager returns current service status. 4.1 If status returned is SERVICE\_UNAVAILABLE (manager is not ready), application should wait for init callback provided in step 1. 4.2 Data profile manager calls application callback with initialization result (success/failure).
5. Application creates listener class of type IDataProfileListener
6. Application register created object in step 5 as listener to data profile changes
7. Application receives the status i.e. either SUCCESS or FAILED based on the execution of registerListener
8. Application requests list of profile

9. Application receives the status i.e. either SUCCESS or FAILED based on the execution of requestProfileList
10. Application gets callback with list of all profiles

### 3.4.3 Data Serving System Manager Call Flow

Data Serving System manager provides the interface to access network and modem low level services. It provides APIs to get current dedicated radio bearer, get current service status and preferred RAT, and get current roaming status. Serving System Listener provides an interface for application to receive data serving system notification events such as change in dedicated radio bearer, change in service status, or change in roaming status. The application must register as a listener for Serving System updates.

#### 3.4.3.1 Get Dedicated Radio Bearer Call Flow

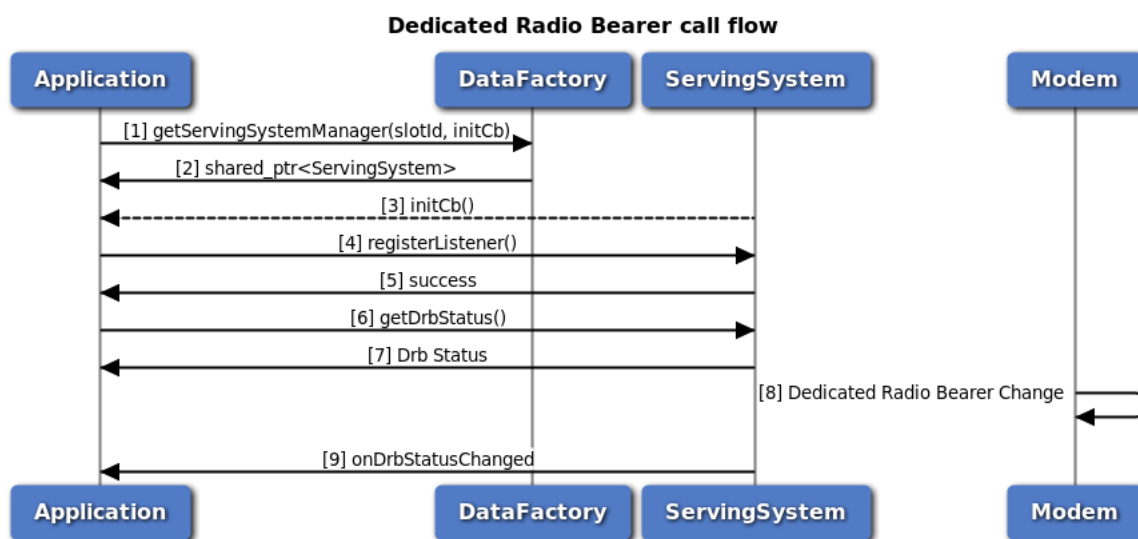

**Figure 3-55 Get Dedicated Radio Bearer Call Flow**

1. Application requests data factory for data serving system manager object with slot Id and init callback.
2. Data factory returns IServingSystemManager object to application.
3. Serving System Manager calls application callback provided in step 1 with initialization result pass/fail.
4. Application register itself as listener with Serving System manager to receive dedicated radio bearer changes notification.
5. Application gets success for registering as listener.
6. Application calls getDrbStatus to get current dedicated radio bearer status.
7. Application receives the current dedicated bearer status.
8. Dedicated radio bearer changes in modem
9. Application gets onDrbStatusChanged indication with new status

### 3.4.3.2 Request Service Status Call Flow

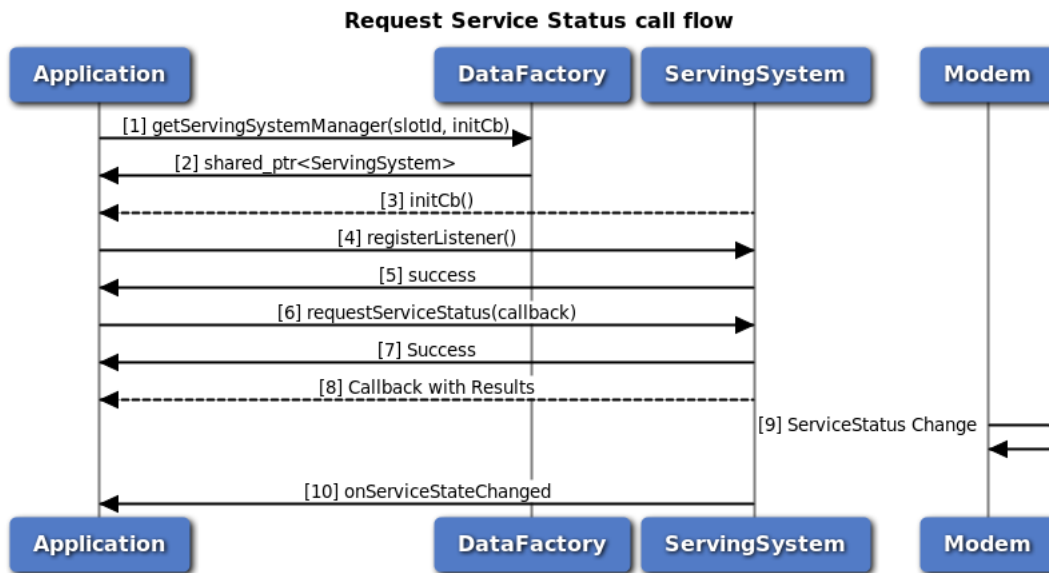

**Figure 3-56 Request service status call flow**

1. Application requests data factory for data servicing system manager object with slot Id and init callback.
2. Data factory returns IServicingSystemManager object to application.
3. Serving System Manager calls application callback provided in step 1 with initialization result pass/fail.
4. Application register itself as listener with Serving System manager to receive service status changes notification.
5. Application gets success for registering as listener.
6. Application calls requestServiceStatus to get current service status and provides callback.
7. Application receives the status i.e. either SUCCESS or FAILED based on the execution of requestServiceStatus.
8. Application gets asynchronous response for requestServiceStatus through callback provided in step 4 with current service status.
9. Service status changes in modem
10. Application gets onServiceStateChanged indication with new status



### 3.4.3.3 Request Roaming Status Call Flow

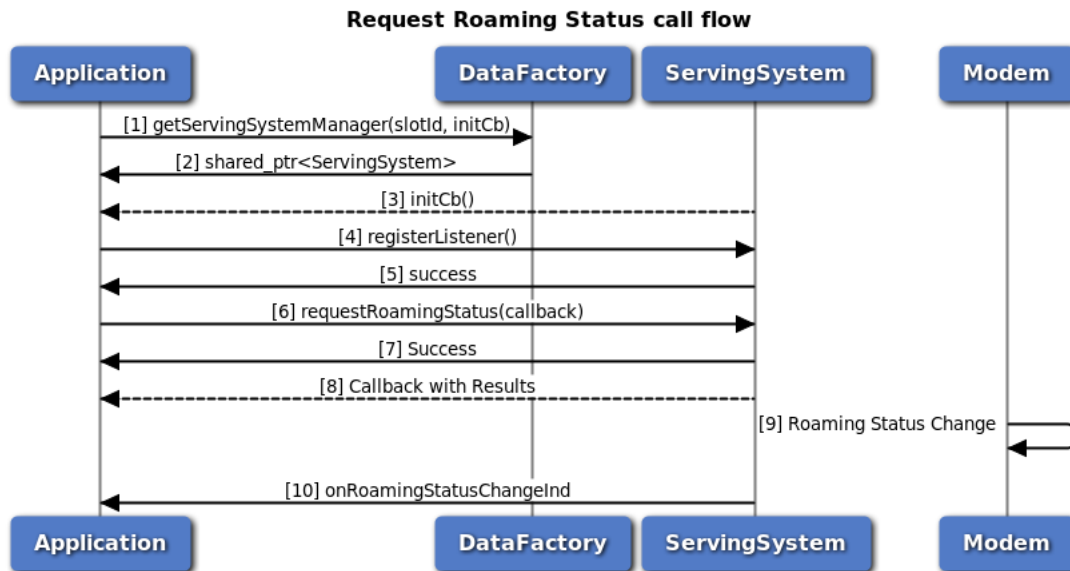

Figure 3-57 Request roaming status call flow

1. Application requests data factory for data serving system manager object with slot Id and init callback.
2. Data factory returns IServingSystemManager object to application.
3. Serving System Manager calls application callback provided in step 1 with initialization result pass/fail.
4. Application register itself as listener with Serving System manager to receive roaming status changes notification.
5. Application gets success for registering as listener.
6. Application calls requestRoamingStatus to get current service status and provides callback.
7. Application receives the status i.e. either SUCCESS or FAILED based on the execution of requestRoamingStatus.
8. Application gets asynchronous response for requestRoamingStatus through callback provided in step 4 with current service status.
9. Roaming status changes in modem
10. Application gets onRoamingStatusChanged indication with new status

### 3.4.4 Data Filter Manager Call Flow

Data Filter manager provides APIs to get/set data filter mode, add/remove data restrict filters. Its API can be used per data call or globally to apply the same changes to all the underlying currently up data call. It also has a listener interface for notifications for data filter status update. Application will get the Data Filter manager object from data factory. The application can register a listener for data filter mode change updates.

### 3.4.4.1 Call flow to Set/Get data filter mode

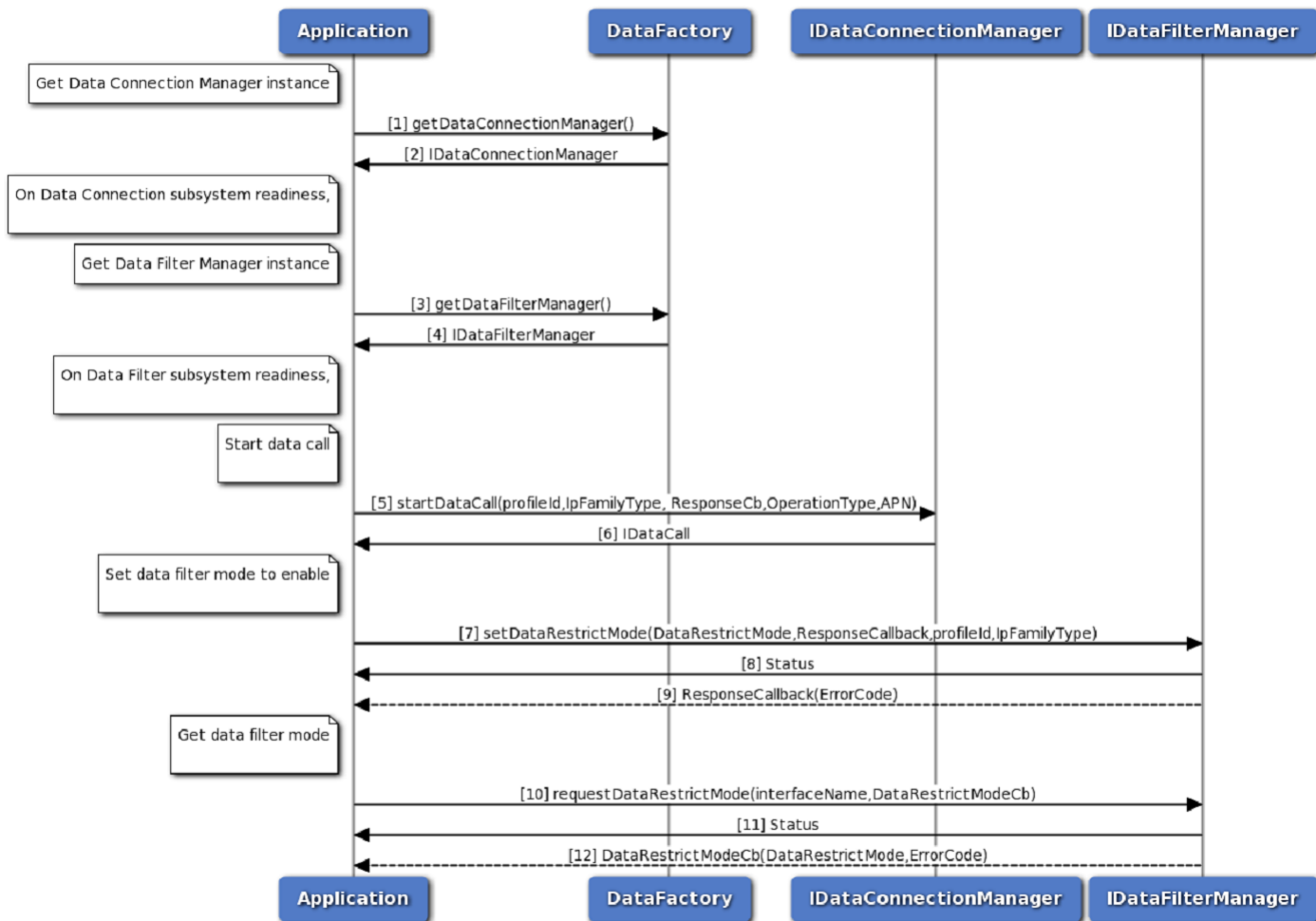

Figure 3-58 Get/Set data filter mode call flow

1. Application requests data factory for data connection manager object.
2. Data factory returns IDataConnectionManager object to application.
3. Application requests data factory for data filter manager object.
4. Data factory returns IDataFilterManager object to application.
5. Application requests for start data call and optionally gets asynchronous response using startDataCallback.
6. Application receives the status i.e. either SUCCESS or FAILED based on the execution of startDataCall.
7. Optionally, the application gets asynchronous response for startDataCall using startDataCallback.
8. Application requests for set data filter mode to enable and optionally gets asynchronous response using ResponseCallback.

9. Application receives the status i.e. either SUCCESS or FAILED based on the execution of setDataRestrictMode.
10. Optionally, the application gets asynchronous response for setDataRestrictMode using ResponseCallback.
11. Application requests for get data filter mode and optionally gets asynchronous response using DataRestrictModeCb.
12. Application receives the status i.e. either SUCCESS or FAILED based on the execution of requestDataRestrictMode.
13. Optionally, the application gets asynchronous response for requestDataRestrictMode using DataRestrictModeCb.

### 3.4.4.2 Call flow to Add data restrict filter

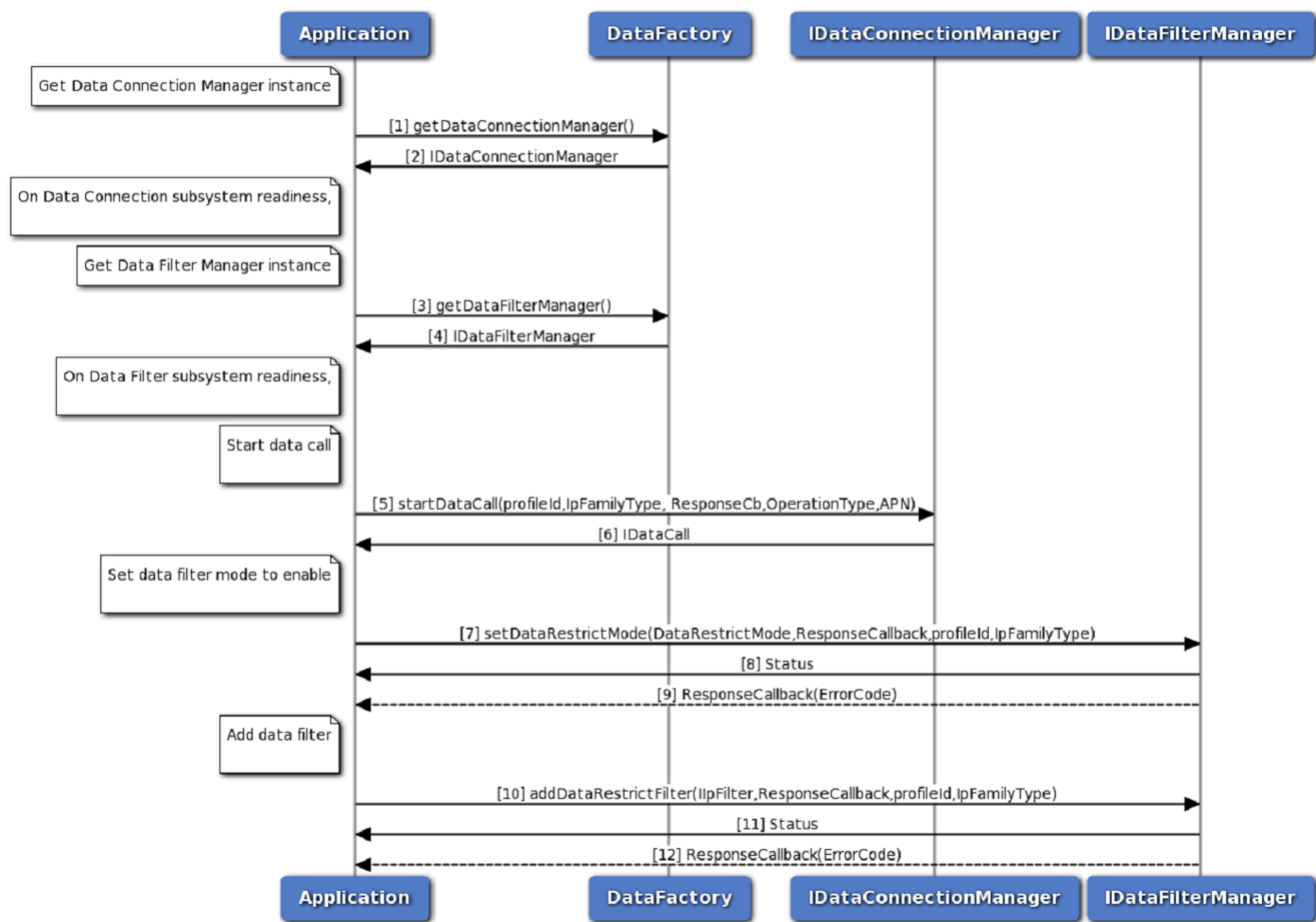

Figure 3-59 Add data restrict filter call flow

1. Application requests data factory for data connection manager object.
2. Data factory returns IDataConnectionManager object to application.

3. Application requests data factory for data filter manager object.
4. Data factory returns IDataFilterManager object to application.
5. Application requests for start data call and optionally gets asynchronous response using startDataCallback.
6. Application receives the status i.e. either SUCCESS or FAILED based on the execution of startDataCall.
7. Optionally, the application gets asynchronous response for startDataCall using startDataCallback.
8. Application requests for add data filter and optionally gets asynchronous response using ResponseCallback.
9. Application receives the status i.e. either SUCCESS or FAILED based on the execution of addDataRestrictFilter.
10. Optionally, the application gets asynchronous response for addDataRestrictFilter using ResponseCallback.

### 3.4.4.3 Call flow to Remove data restrict filter

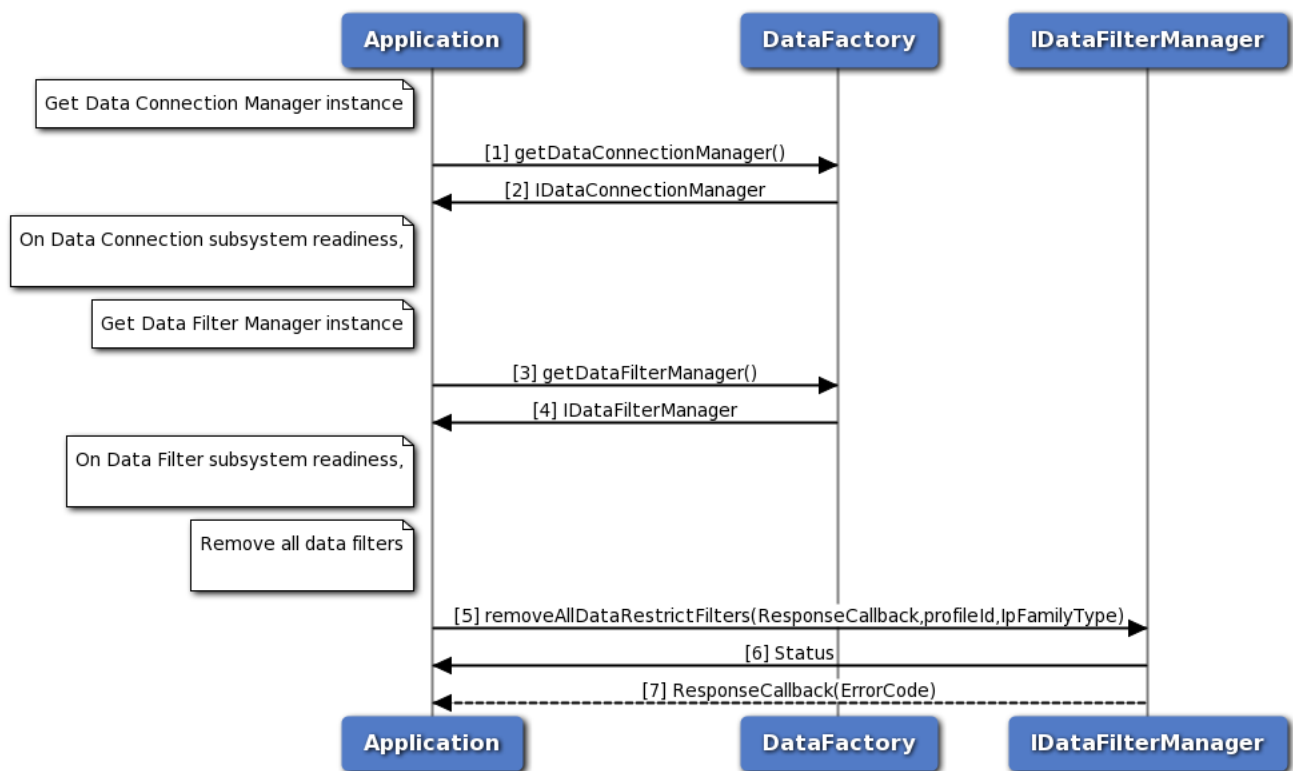

Figure 3-60 Remove data restrict filter call flow

1. Application requests data factory for data connection manager object.
2. Data factory returns IDataConnectionManager object to application.
3. Application requests data factory for data filter manager object.

4. Data factory returns IDataFilterManager object to application.
5. Application requests for start data call and optionally gets asynchronous response using startDataCallback.
6. Application receives the status i.e. either SUCCESS or FAILED based on the execution of startDataCall.
7. Optionally, the application gets asynchronous response for startDataCall using startDataCallback.
8. Application requests for add data filter and optionally gets asynchronous response using ResponseCallback.
9. Application receives the status i.e. either SUCCESS or FAILED based on the execution of removeAllDataRestrictFilters.
10. Optionally, the application gets asynchronous response for removeAllDataRestrictFilters using ResponseCallback.

### **3.4.5 Data Networking Call Flow**

Application will get the following manager objects from data factory to configure networking. IVlanManager is used to access all VLAN APIs. INatManager is used to access all Static NAT APIs. IFirewallManager is used to access all Firewall APIs.

### 3.4.5.1 Create VLAN and Bind it to PDN in data vlan manager call flow

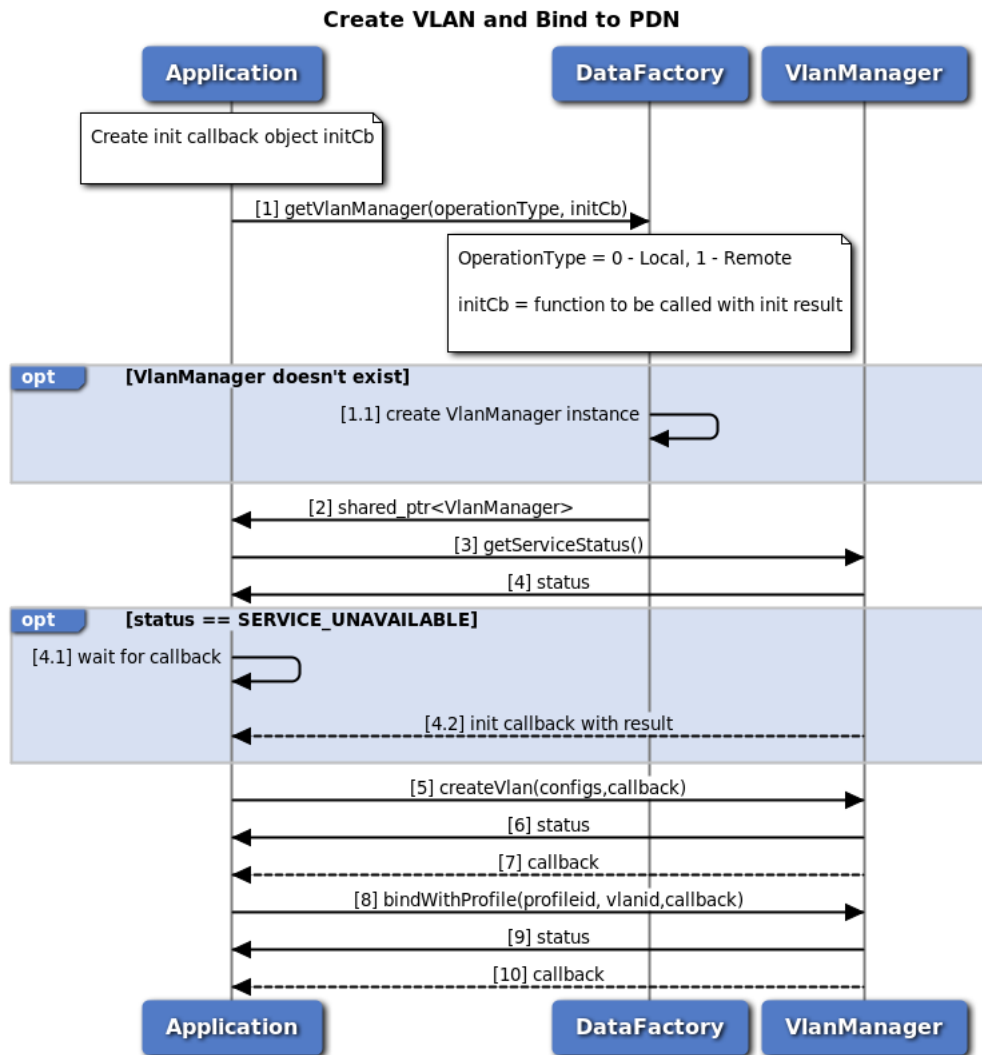

Figure 3-61 Create VLAN and bind it to PDN for data VLAN manager call flow

1. Application requests data factory for data IVlanManager object. Application can optionally provide callback to be called when manager initialization is completed. 1.1. If IVlanManager object does not exist, data factory will create new object.
2. Data factory returns shared pointer to IVlanManager object to application.
3. Application request current service status of vlan manager returned by data factory
4. The application receives the Status i.e. either true or false to indicate whether sub-system is ready or not. 4.1. If status returned is SERVICE\_UNAVAILABLE (manager is not ready), application should wait for init callback provided in step 1 4.2. Vlan manager calls application callback with initialization result (success/failure).
5. On success, application calls IVlanManager::createVlan with assigned id, interface, and acceleration type.
6. Application receives synchronous Status which indicates if the IVlanManager::createVlan request

was sent successfully.

7. Application is notified of the Status of the IVlanManager::createVlan request (either SUCCESS or FAILED) via the application-supplied callback.
8. Application calls IVlanManager::bindWithProfile with Vlan id and profile id.
9. Application receives synchronous Status which indicates if the IVlanManager::bindWithProfile request was sent successfully.
1. Application is notified of the Status of the IVlanManager::bindWithProfile request (either SUCCESS or FAILED) via the application-supplied callback.

### 3.4.5.2 LAN-LAN VLAN Configuration from EAP usecase call flow

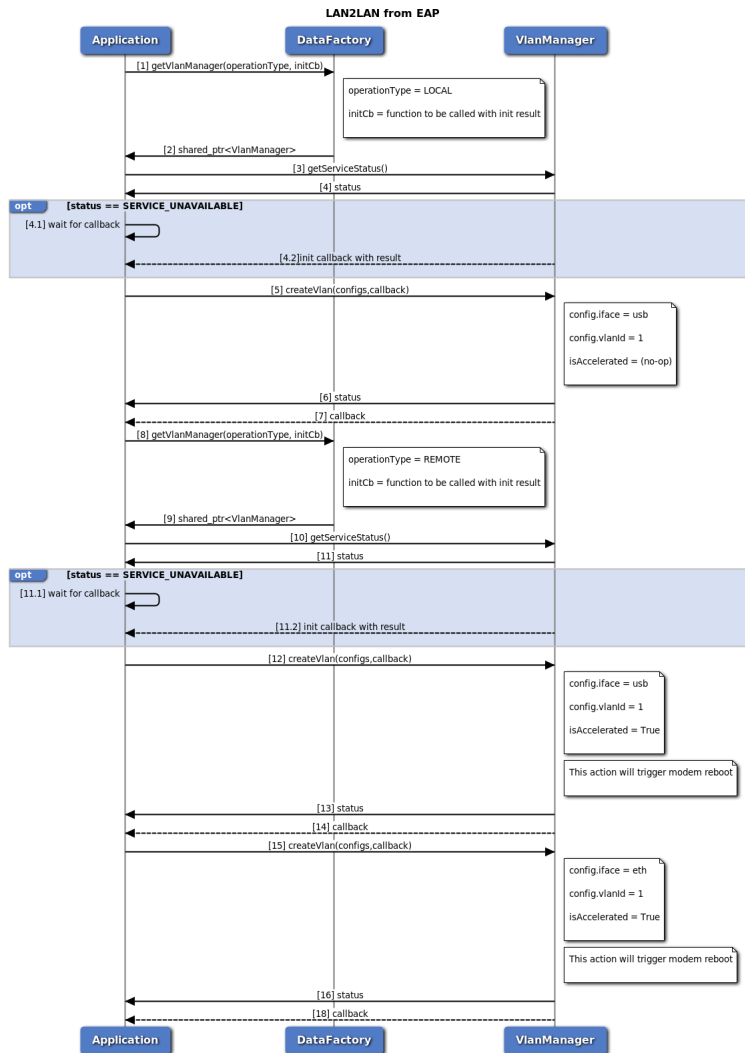

Figure 3-62 LAN-LAN VLAN Configuration Usecase from EAP call flow

1. Application requests data factory for data IVlanManager for local operation object. Application can optionally provide callback to be called when manager initialization is completed.
2. Data factory returns shared pointer to local vlan manager object to application.

3. Application request current service status of local vlan manager returned by data factory.
4. Vlan manager returns current service status. 4.1 If status returned is SERVICE\_UNAVAILABLE (manager is not ready), application should wait for init callback provided in step 1. 4.2 Vlan manager calls application callback with initialization result (success/failure).
5. On success, application calls IVlanManager::createVlan with USB interface, Vlan id 1 and no acceleration.
6. Vlan manager returns synchronous response to application (success/fail).
7. Vlan manager calls application provided callback in step 5 with createVlan results
8. Application requests data factory for data IVlanManager for remote operation object. Application can optionally provide callback to be called when manager initialization is completed.
9. Data factory returns shared pointer to remote vlan manager object to application.
10. Application request current service status of remote vlan manager returned by data factory.
11. Vlan manager returns current service status. 11.1 If status returned is SERVICE\_UNAVAILABLE (manager is not ready), application should wait for init callback provided in step 1. 11.2 Vlan manager calls application callback with initialization result (success/failure).
12. On success, application calls IVlanManager::createVlan with USB interface, Vlan id 1 and acceleration.
13. Vlan manager returns synchronous response to application (success/fail).
14. Vlan manager calls application provided callback in step 12 with createVlan results.
15. Application calls IVlanManager::createVlan with ETH interface, Vlan id 1 and acceleration.
16. Vlan manager returns synchronous response to application (success/fail).
17. Vlan manager calls application provided callback in step 15 with createVlan results.



### 3.4.5.3 LAN-LAN VLAN Configuration from A7 usecase call flow

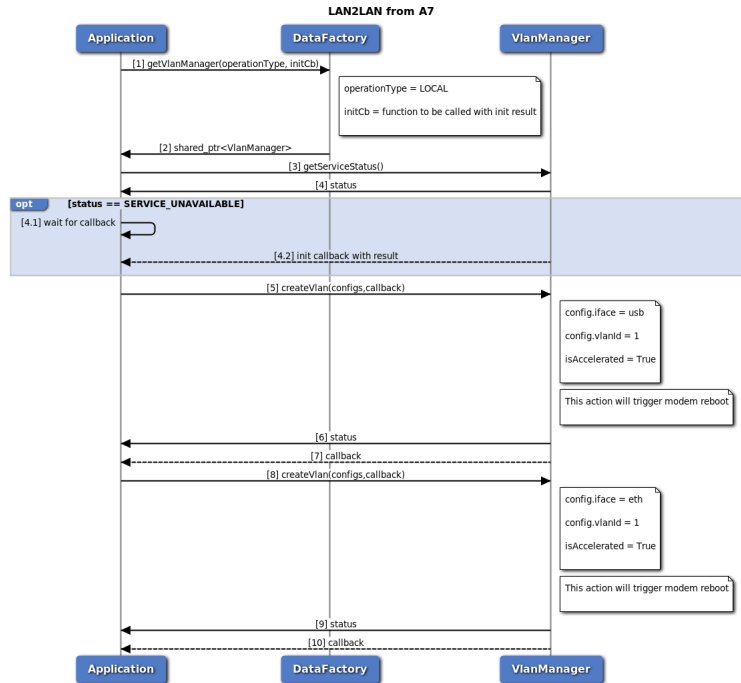

**Figure 3-63 LAN-LAN VLAN Configuration Use Case from A7 call flow**

1. Application requests data factory for data IVlanManager for local operation object. Application can optionally provide callback to be called when manager initialization is completed.
2. Data factory returns shared pointer to local vlan manager object to application.
3. Application request current service status of local vlan manager returned by data factory.
4. Vlan manager returns current service status. 4.1 If status returned is SERVICE\_UNAVAILABLE (manager is not ready), application should wait for init callback provided in step 1. 4.2 Vlan manager calls application callback with initialization result (success/failure).
5. On success, application calls IVlanManager::createVlan with USB interface, Vlan id 1 and acceleration.
6. Vlan manager returns synchronous response to application (success/fail).
7. Vlan manager calls application provided callback in step 5 with createVlan results.
8. Application calls IVlanManager::createVlan with ETH interface, Vlan id 1 and acceleration.
9. Vlan manager returns synchronous response to application (success/fail).
10. Vlan manager calls application provided callback in step 8 with createVlan results.

### 3.4.5.4 LAN-WAN VLAN Configuration from EAP usecase call flow

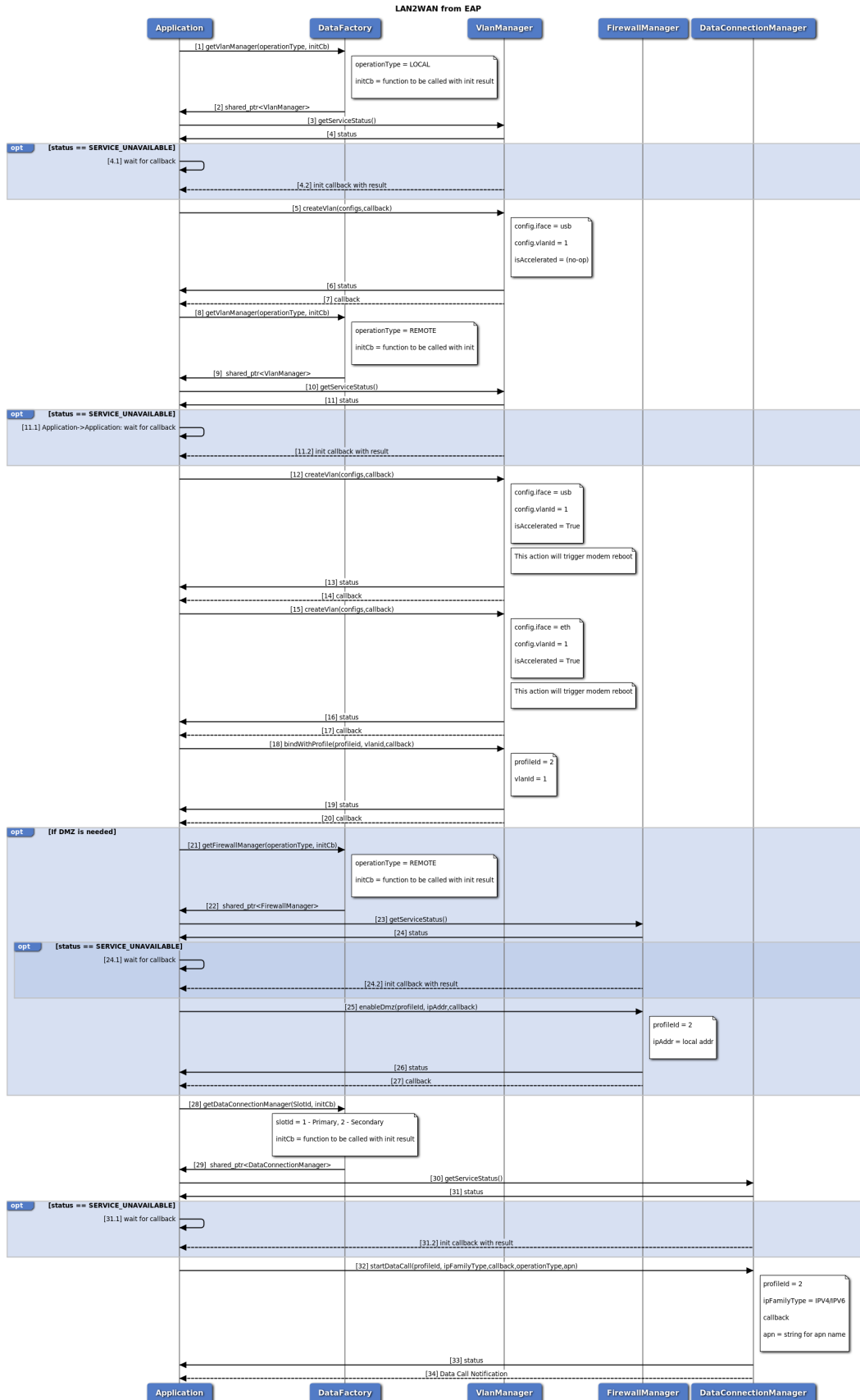

Figure 3-64 LAN-WAN VLAN Configuration Usecase from EAP call flow

1. Application requests data factory for local data vlan manager object.
2. Data factory returns shared pointer to local vlan manager to application.
3. Application request current service status of local vlan manager returned by data factory.
4. Vlan manager returns current service status. 4.1 If status returned is SERVICE\_UNAVAILABLE (manager is not ready), application should wait for init callback provided in step 1. 4.2 Vlan manager calls application callback with initialization result (success/failure).
5. On success, application calls IVlanManager::createVlan with USB interface, Vlan id 1 and no acceleration.
6. Vlan manager returns synchronous response to application (success/fail).
7. Vlan manager calls application provided callback in step 5 with createVlan results.
8. Application requests data factory for remote data vlan manager object.
9. Data factory returns shared pointer to remote vlan manager to application.
10. Application request current service status of remote vlan manager returned by data factory.
11. Vlan manager returns current service status. 11.1 If status returned is SERVICE\_UNAVAILABLE (manager is not ready), application should wait for init callback provided in step 8. 11.2 Vlan manager calls application callback with initialization result (success/failure).
12. On success, application calls IVlanManager::createVlan with USB interface, Vlan id 1 and acceleration.
13. Vlan manager returns synchronous response to application (success/fail).
14. Vlan manager calls application provided callback in step 12 with createVlan results.
15. Application calls IVlanManager::createVlan with ETH interface, Vlan id 1 and acceleration.
16. Vlan manager returns synchronous response to application (success/fail).
17. Vlan manager calls application provided callback in step 15 with createVlan results.
18. Application calls IVlanManager::bindWithProfile with profile id to bind with.
19. Vlan manager returns synchronous response to application (success/fail).
20. Vlan manager calls application provided callback in step 18 with bindWithProfile results. If DMZ is needed:
  - (a) Application requests data factory for firewall manager object.
  - (b) Data factory returns shared pointer to firewall manager to application.
  - (c) Application request current service status of firewall manager returned by data factory.
  - (d) Firewall manager returns current service status. 24.1 If status returned is SERVICE\_UNAVAILABLE (manager is not ready), application should wait for init callback provided in step 21. 24.2 Firewall manager calls application callback with initialization result (success/failure).
  - (e) Application calls firewall manager enableDmz with profile id and local address to be enable Dmz on.
  - (f) Firewall manager returns synchronous response to application (success/fail).
  - (g) Firewall manager calls application provided callback in step 25 with enableDmz results.
21. Application requests data factory for data connection manager object.

22. Data factory returns shared pointer to data connection manager to application.
23. Application request current service status of data connection manager returned by data factory.
24. Data connection manager returns current service status. 31.1 If status returned is SERVICE\_UNAVAILABLE (manager is not ready), application should wait for init callback provided in step 28.  
31.2 Data connection manager calls application callback with initialization result (success/failure).
25. Application can call data Connection manager startDataCall with profile id to start data call on, Ip Family type, operation Type and APN Name.
26. Data connection Manager returns synchronous response to application (success/fail).
27. Data connection Manager returns notification to application with data call details.

### 3.4.5.5 LAN-WAN VLAN Configuration from A7 usecase call flow

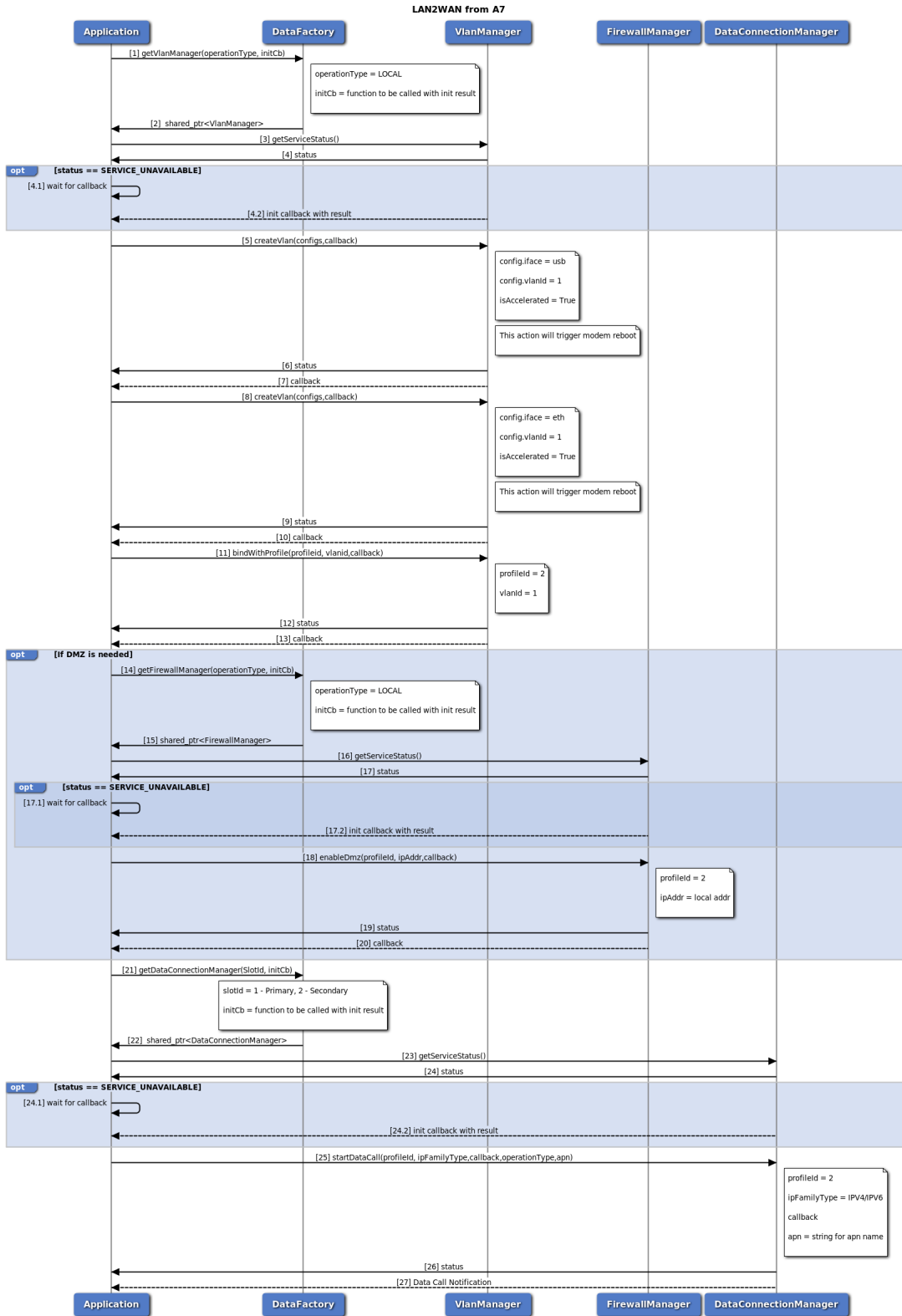

Figure 3-65 LAN-WAN VLAN Configuration Usecase from A7 call flow

1. Application requests data factory for local data vlan manager object.
2. Data factory returns shared pointer to local vlan manager to application.
3. Application request current service status of local vlan manager returned by data factory.
4. Vlan manager returns current service status. 4.1 If status returned is SERVICE\_UNAVAILABLE (manager is not ready), application should wait for init callback provided in step 1. 4.2 Vlan manager calls application callback with initialization result (success/failure).
5. On success, application calls IVlanManager::createVlan with USB interface, Vlan id 1 and acceleration.
6. Vlan manager returns synchronous response to application (success/fail).
7. Vlan manager calls application provided callback in step 5 with createVlan results.
8. Application calls IVlanManager::createVlan with ETH interface, Vlan id 1 and acceleration.
9. Vlan manager returns synchronous response to application (success/fail).
10. Vlan manager calls application provided callback in step 8 with createVlan results.
11. Application calls IVlanManager::bindWithProfile with profile id to bind with.
12. Vlan manager returns synchronous response to application (success/fail).
13. Vlan manager calls application provided callback in step 11 with bindWithProfile results. If DMZ is needed:
  - (a) Application requests data factory for firewall manager object.
  - (b) Data factory returns shared pointer to firewall manager to application.
  - (c) Application request current service status of firewall manager returned by data factory.
  - (d) Firewall manager returns current service status. 17.1 If status returned is SERVICE\_UNAVAILABLE (manager is not ready), application should wait for init callback provided in step 14. 17.2 Firewall manager calls application callback with initialization result (success/failure).
  - (e) Application calls firewall manager enableDmz with profile id and local address to be enable Dmz on.
  - (f) Firewall manager returns synchronous response to application (success/fail).
  - (g) Firewall manager calls application provided callback in step 25 with enableDmz results.
14. Application requests data factory for data connection manager object.
15. Data factory returns shared pointer to data connection manager to application.
16. Application request current service status of data connection manager returned by data factory.
17. Data connection manager returns current service status. 24.1 If status returned is SERVICE\_UNAVAILABLE (manager is not ready), application should wait for init callback provided in step 21. 24.2 Data connection manager calls application callback with initialization result (success/failure).
18. Application can call data Connection manager startDataCall with profile id to start data call on, Ip Family type, operation Type and APN Name.
19. Data connection Manager returns synchronous response to application (success/fail).
20. Data connection Manager returns notification to application with data call details.

### 3.4.5.6 Create Static NAT entry in data Static NAT manager call flow

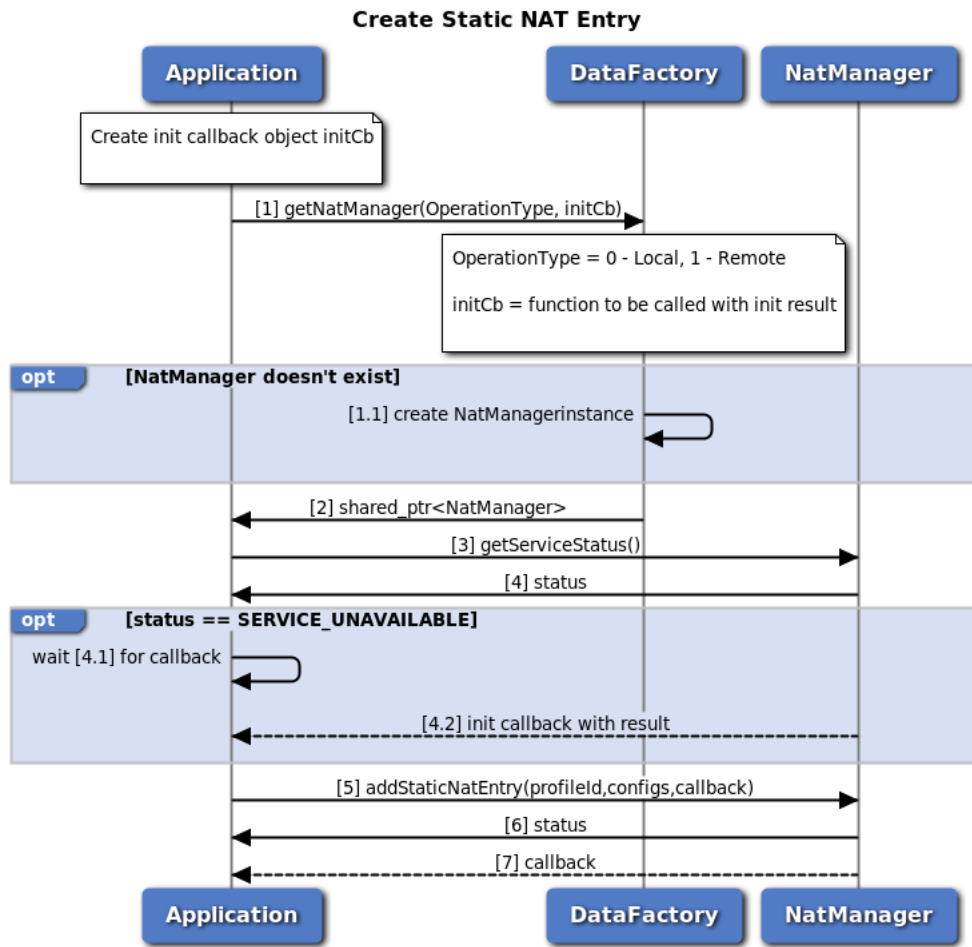
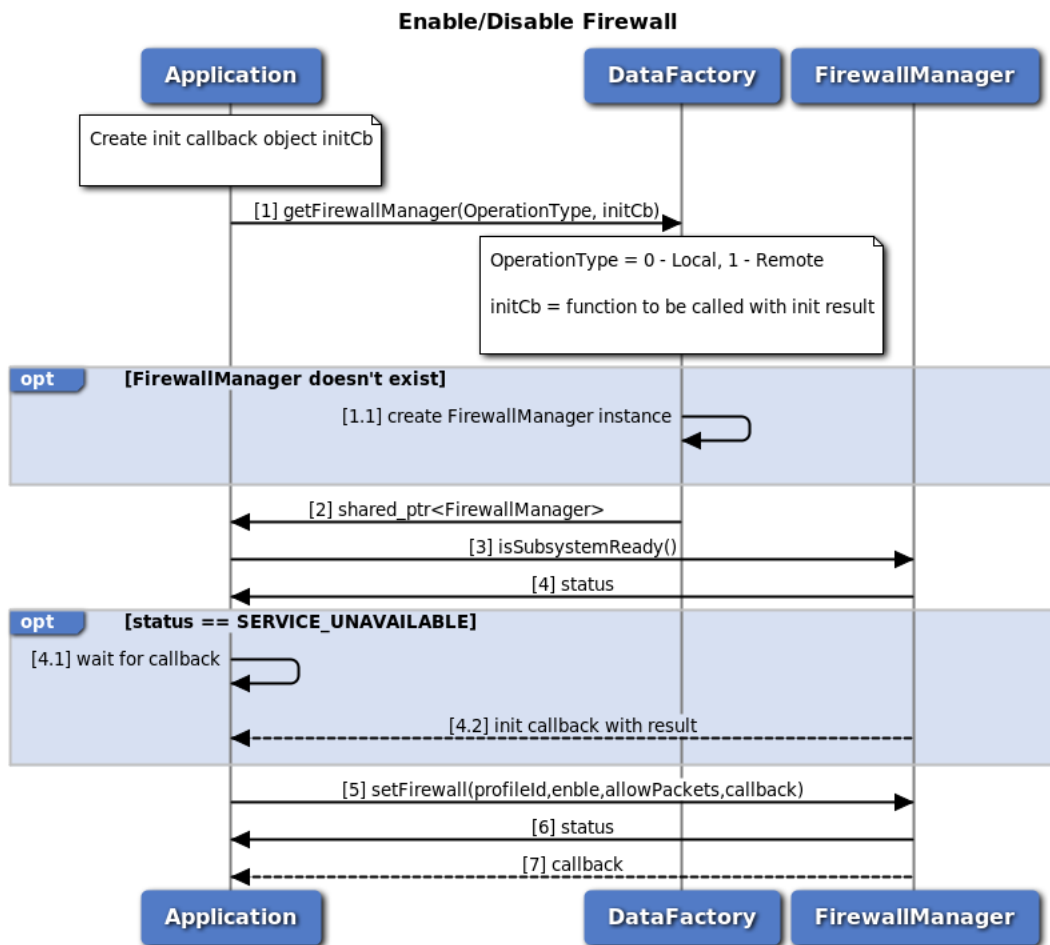

Figure 3-66 Create Static NAT entry for data NAT manager call flow

1. Application requests data factory for data nat manager object. 1.1. If nat manager object does not exist, data factory will create new object.
2. Data factory returns shared pointer to nat manager object to application.
3. Application request current service status of nat manager returned by data factory.
4. Nat manager returns current service status. 4.1 If status returned is SERVICE\_UNAVAILABLE (manager is not ready), application should wait for init callback provided in step 1. 4.2 Nat manager calls application callback with initialization result (success/failure).
5. On success, application calls nat manager addStaticNatEntry with profileId, private IP address port, private port, global port and IP Protocol.
6. Application receives synchronous Status which indicates if the nat manager addStaticNatEntry request was sent successfully.
7. Application is notified of the result of the nat manager addStaticNatEntry request (either SUCCESS or FAILED) via the application-supplied callback.

### 3.4.5.7 Firewall Enablement in data Firewall manager call flow

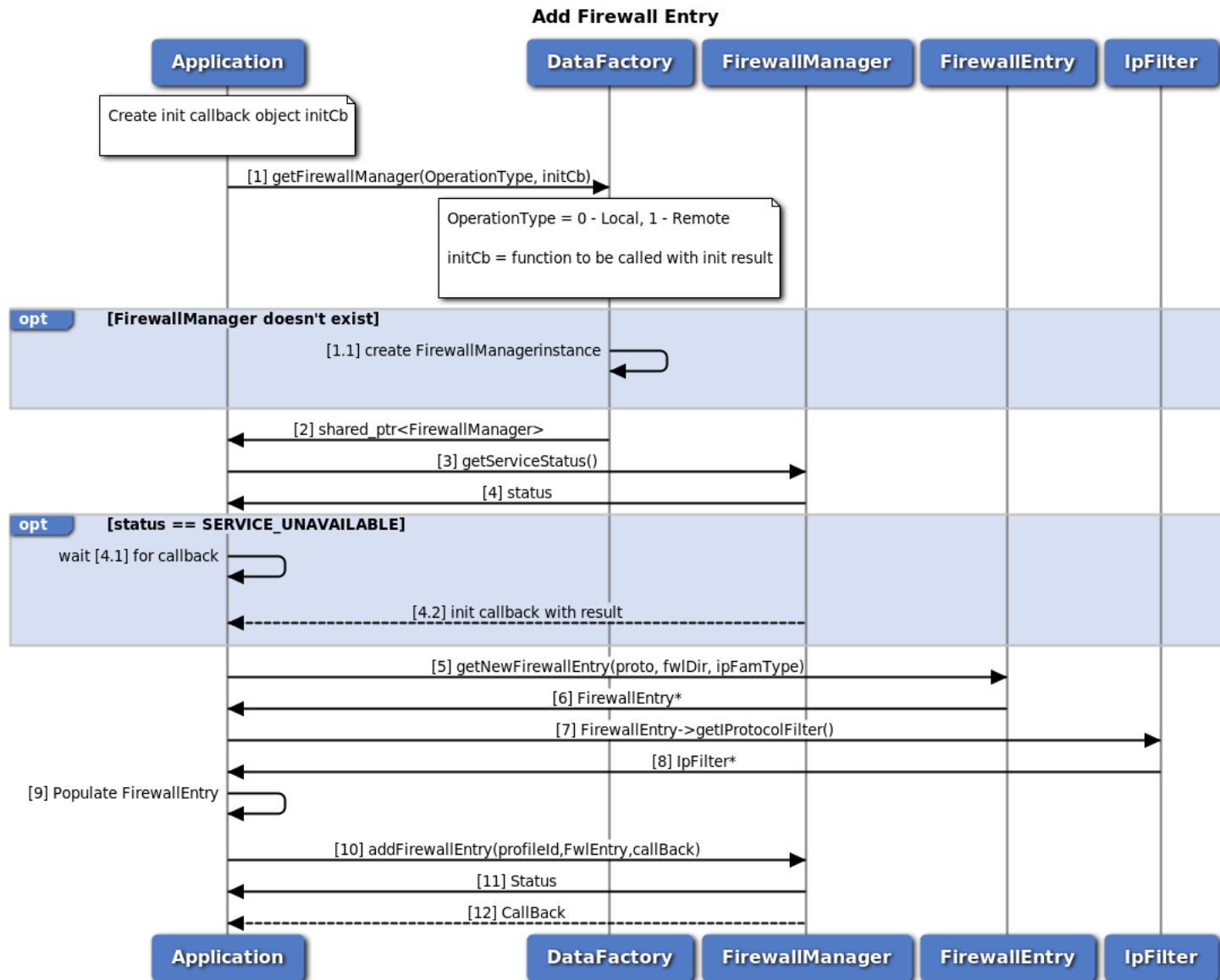

**Figure 3-67 Firewall enablement in data Firewall manager call flow**

1. Application requests data factory for data firewall manager object. 1.1. If firewall manager object does not exist, data factory will create new object.
2. Data factory returns shared pointer to firewall manager object to application.
3. Application request current service status of firewall manager returned by data factory.
4. Firewall manager returns current service status. 4.1 If status returned is `SERVICE_UNAVAILABLE` (manager is not ready), application should wait for init callback provided in step 1. 4.2 Firewall manager calls application callback with initialization result (success/failure).
5. On success, application calls firewall manager `setFirewall` with enable/disable and allow/drop packets.
6. Application receives synchronous Status which indicates if the firewall manager `setFirewall` request was sent successfully.
7. Application is notified of the Status of the firewall manager `setFirewall` request (either `SUCCESS` or `FAILED`) via the application-supplied callback.



### 3.4.5.8 Add Firewall Entry in data Firewall manager call flow

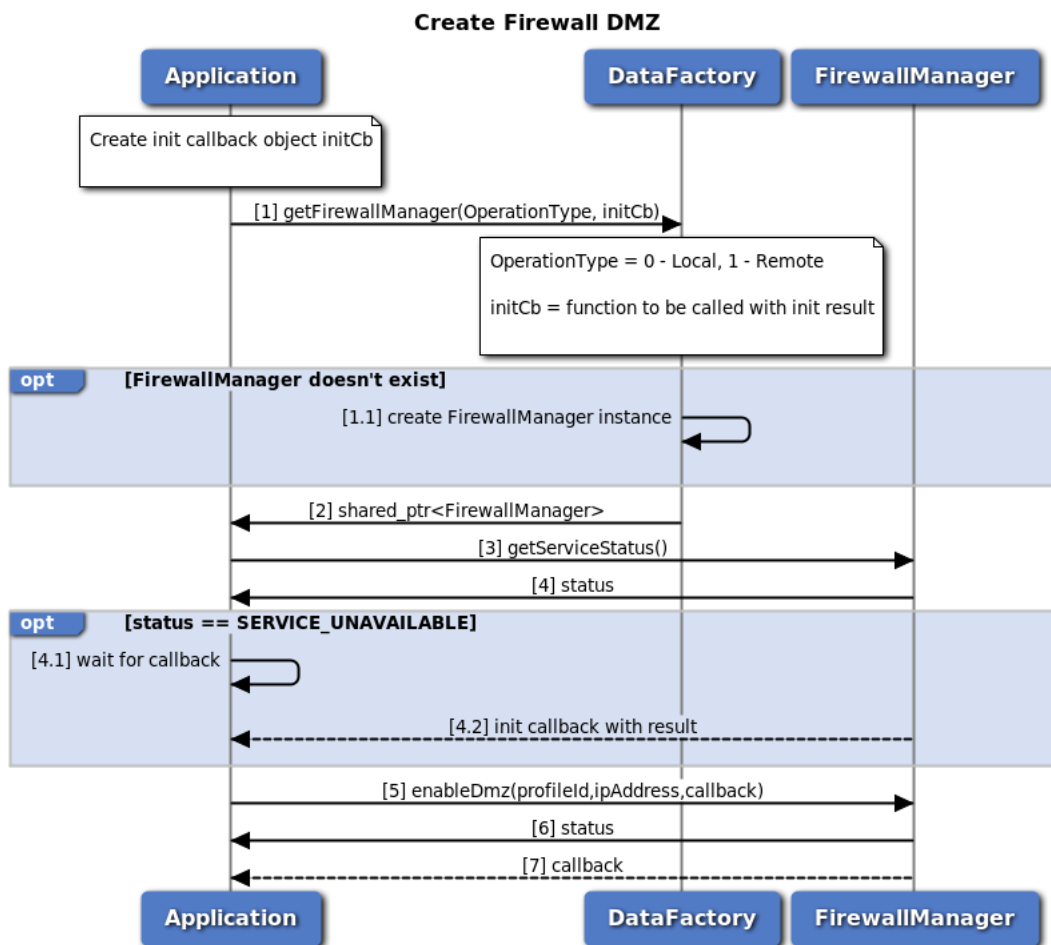

**Figure 3-68 Add Firewall entry in data Firewall manager call flow**

1. Application requests data factory for data firewall manager object. 1.1. If firewall manager object does not exist, data factory will create new object.
2. Data factory returns shared pointer to firewall manager object to application.
3. Application request current service status of data profile manager returned by data factory.
4. Firewall manager returns current service status. 4.1 If status returned is `SERVICE_UNAVAILABLE` (manager is not ready), application should wait for init callback provided in step 1. 4.2 Firewall manager calls application callback with initialization result (success/failure).
5. On success, application calls firewall manager `getNewFirewallEntry` to get `FirewallEntry` object.

6. Application receives Firewall Entry object.
7. Using Firewall Entry object, application calls `IFirewallEntry::getProtocolFilter` to get protocol filter object
8. Application receives `IpFilter` object.
9. Application populates `FirewallEntry` and `IpFilter` objects.
10. Application calls `IFirewallManager::addFirewallEntry` with `profileId` and `FirewallEntry` to add firewall entry
11. Application receives synchronous `Status` which indicates if `addFirewallEntry` was sent successfully
12. Application is notified of the `Status` of the `IFirewallManager::addFirewallEntry` request (either `SUCCESS` or `FAILED`) via the application-supplied callback.

### 3.4.5.9 Set Firewall DMZ in data Firewall manager call flow

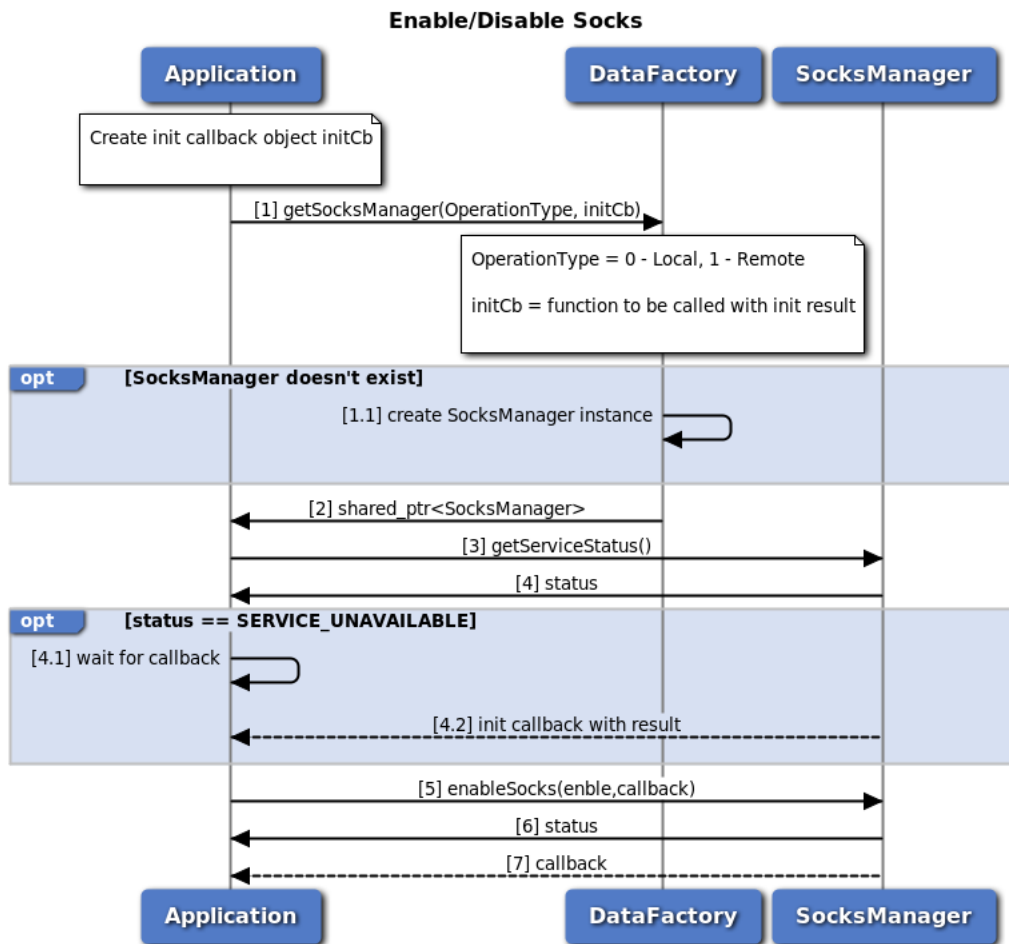

**Figure 3-69 Set Firewall DMZ in data Firewall manager call flow**

1. Application requests data factory for data firewall manager object. 1.1. If firewall manager object does not exist, data factory will create new object.
2. Data factory returns shared pointer to firewall manager object to application.

3. Application request current service status of firewall manager returned by data factory.
4. Firewall manager returns current service status. 4.1 If status returned is `SERVICE_UNAVAILABLE` (manager is not ready), application should wait for init callback provided in step 1. 4.2 Firewall manager calls application callback with initialization result (success/failure).
5. On success, application calls firewall manager `enableDmz` with `profileId` and IP Address.
6. Application receives synchronous Status which indicates if the firewall manager `enableDmz` request was sent successfully.
7. Application is notified of the Status of the firewall manager `enableDmz` request (either `SUCCESS` or `FAILED`) via the application-supplied callback.

### 3.4.5.10 Socks Enablement in data Socks manager call flow

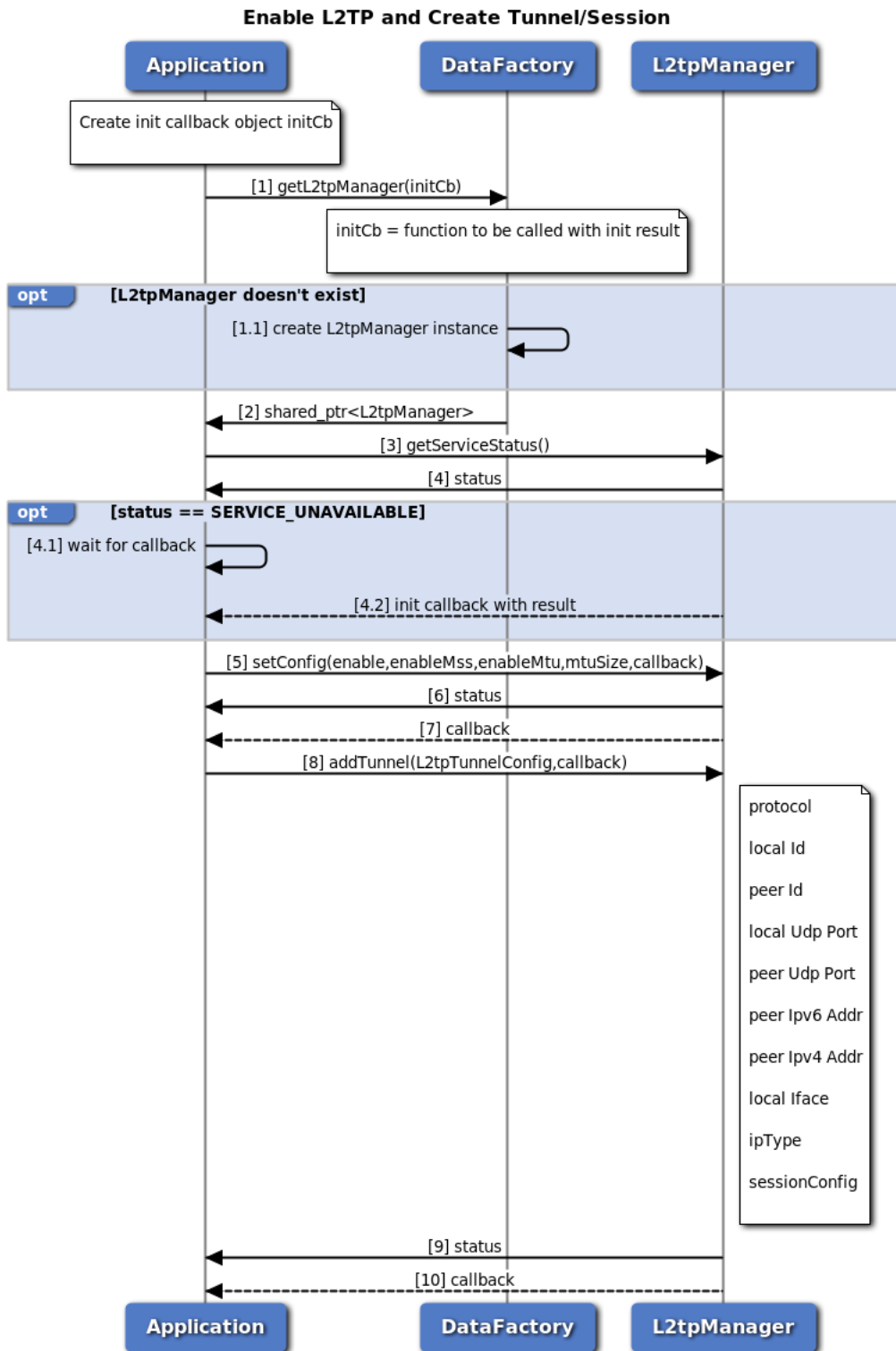

**Figure 3-70 Socks enablement in data Socks manager call flow**

1. Application requests data factory for data socks manager object. 1.1. If socks manager object does not exist, data factory will create new object.
2. Data factory returns shared pointer to socks manager object to application.
3. Application request current service status of socks manager returned by data factory.

4. Socks manager returns current service status. 4.1 If status returned is SERVICE\_UNAVAILABLE (manager is not ready), application should wait for init callback provided in step 1. 4.2 Socks manager calls application callback with initialization result (success/failure).
5. On success, application calls socks manager enableSocks with enable/disable.
6. Application receives synchronous Status which indicates if the socks manager enableSocks request was sent successfully.
7. Application is notified of the Status of the socks manager enableSocks request (either SUCCESS or FAILED) via the application-supplied callback.

### 3.4.5.11 L2TP Enablement and Configuration in data L2TP manager call flow

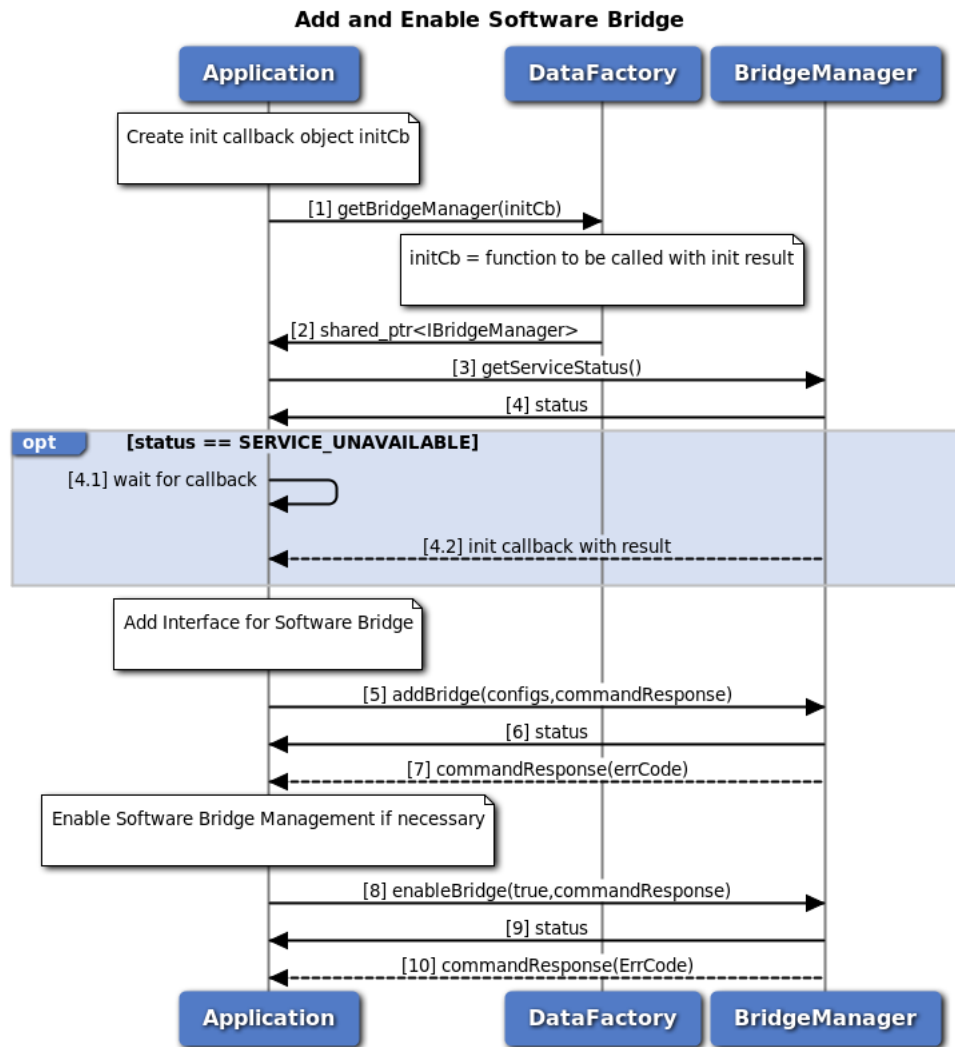

**Figure 3-71 L2TP enablement and Configuration in data L2TP manager call flow**

1. Application requests data factory for data l2tp manager object. 1.1. If l2tp manager object does not exist, data factory will create new object.

2. Data factory returns shared pointer to l2tp manager object to application.
3. Application request current service status of l2tp manager returned by data factory.
4. L2tp manager returns current service status. 4.1 If status returned is SERVICE\_UNAVAILABLE (manager is not ready), application should wait for init callback provided in step 1. 4.2 L2tp manager calls application callback with initialization result (success/failure).
5. On success, application calls l2tp manager setConfig with enable/disable, enable/disable Mss, enable/disable MTU size and MTU size
6. Application receives synchronous Status which indicates if the l2tp manager setConfig request was sent successfully.
7. Application is notified of the Status of the l2tp manager setConfig request (either SUCCESS or FAILED) via the application-supplied callback.
8. Application calls l2tp manager setConfig with all required configurations to setup tunnel and session
9. Application receives synchronous Status which indicates if the l2tp manager setConfig request was sent successfully.
10. Application is notified of the Status of the l2tp manager setConfig request (either SUCCESS or FAILED) via the application-supplied callback.

### 3.4.5.12 Call flow to add and enable software bridge



**Figure 3-72 Call flow to add and enable a software bridge**

1. Application requests data factory for bridge manager object.
2. Data factory returns shared pointer to bridge manager object to application.
3. Application request current service status of bridge manager returned by data factory.
4. Bridge manager returns current service status. 4.1 If status returned is `SERVICE_UNAVAILABLE` (manager is not ready), application should wait for init callback provided in step 1. 4.2 Bridge manager calls application callback with initialization result (success/failure).
5. On success, application requests to add software bridge configuration for an interface, providing an optional asynchronous response callback using `addBridge` API.
6. Application receives the synchronous status i.e. either `SUCCESS` or `FAILED` which indicates if the request was sent successfully.
7. Optionally, the application gets asynchronous response for `addBridge` via the application-supplied callback.

8. If the software bridge management is not enabled already, application requests to enable it, providing an optional asynchronous response callback using enableBridge API. Please note that this step affects all the software bridges configured in the system.
9. Application receives the status i.e. either SUCCESS or FAILED which indicates if the request was sent successfully.
10. Optionally, the application gets asynchronous response for enableBridge via the application-supplied callback.

### 3.4.5.13 Call flow to remove and disable software bridge

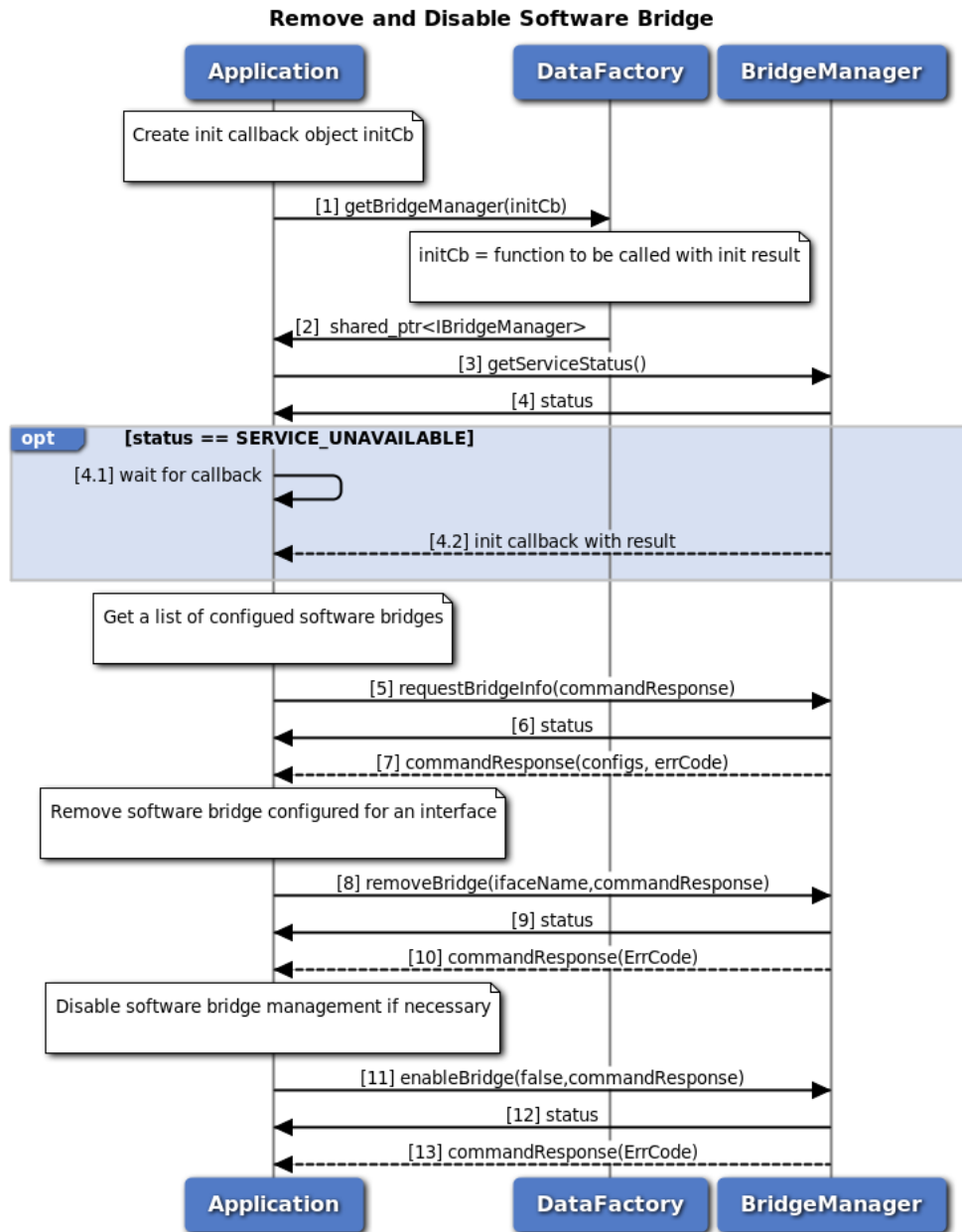

Figure 3-73 Call flow to remove and disable a software bridge



1. Application requests data factory for bridge manager object.
2. Data factory returns shared pointer to bridgeManager object to application.
3. Application request current service status of bridge manager returned by data factory.
4. Bridge manager returns current service status. 4.1 If status returned is SERVICE\_UNAVAILABLE (manager is not ready), application should wait for init callback provided in step 1. 4.2 Bridge manager calls application callback with initialization result (success/failure).
5. On success, application requests to get the list of software bridge configurations, providing an asynchronous response callback using requestBridgeInfo API.
6. Application receives the synchronous status i.e. either SUCCESS or FAILED which indicates if the request was sent successfully.
7. The application gets asynchronous response for requestBridgeInfo via the application-supplied callback.
8. Application requests to remove software bridge configuration for an interface, providing an optional asynchronous response callback using removeBridge API.
9. Application receives the synchronous status i.e. either SUCCESS or FAILED which indicates if the request was sent successfully.
10. Optionally, the application gets asynchronous response for removeBridge via the application-supplied callback.
11. If the software bridge management needs to be disabled, application requests to disable it, providing an optional asynchronous response callback using enableBridge API. Please note that this step affects all the software bridges configured in the system.
12. Application receives the status i.e. either SUCCESS or FAILED which indicates if the request was sent successfully.
13. Optionally, the application gets asynchronous response for enableBridge via the application-supplied callback.

## 3.5 C-V2X

Applications need to have "radio" Linux group permissions to be able to operate successfully with underlying services.

### 3.5.1 Retrieve/Update C-V2X Configuration

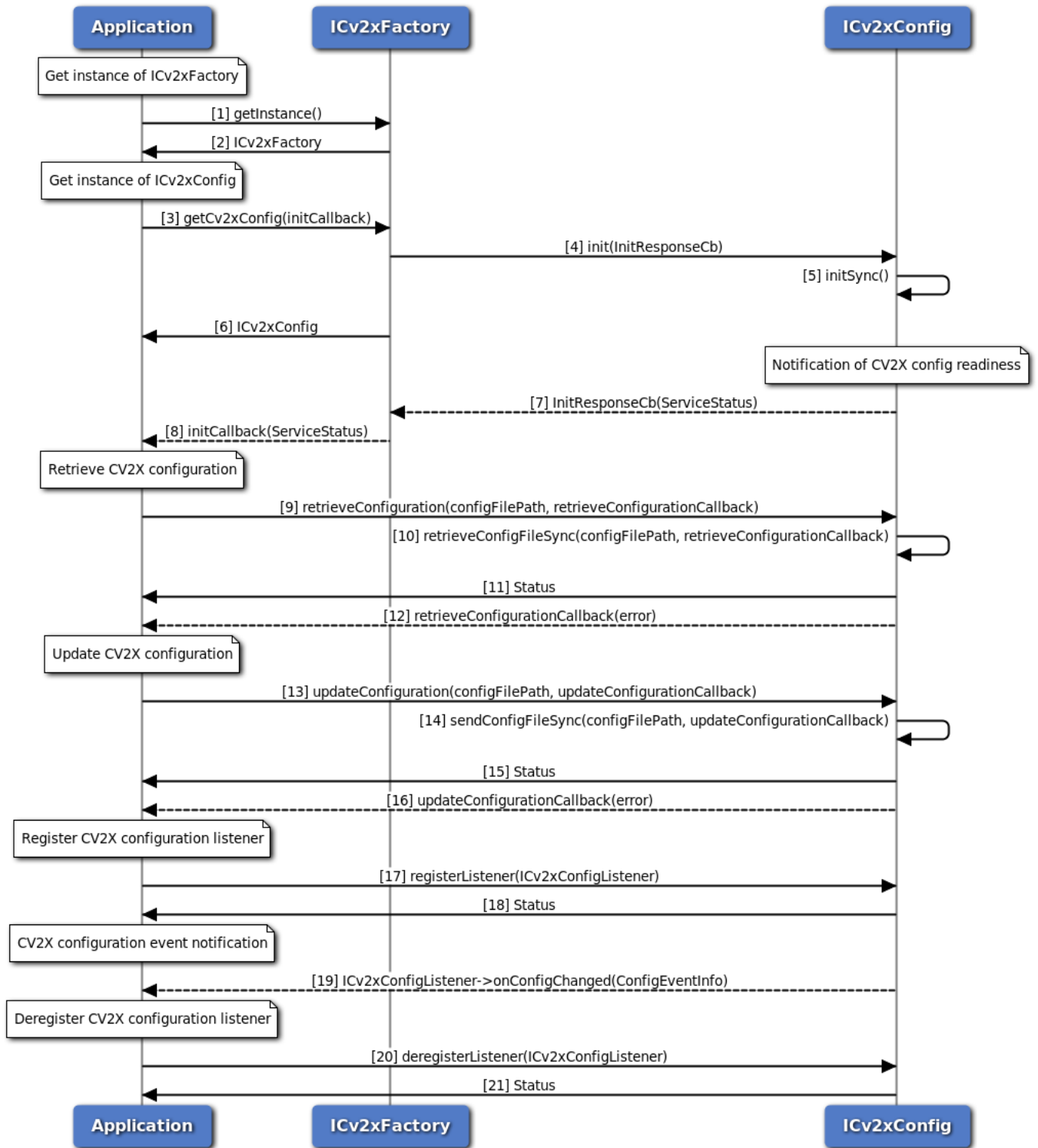
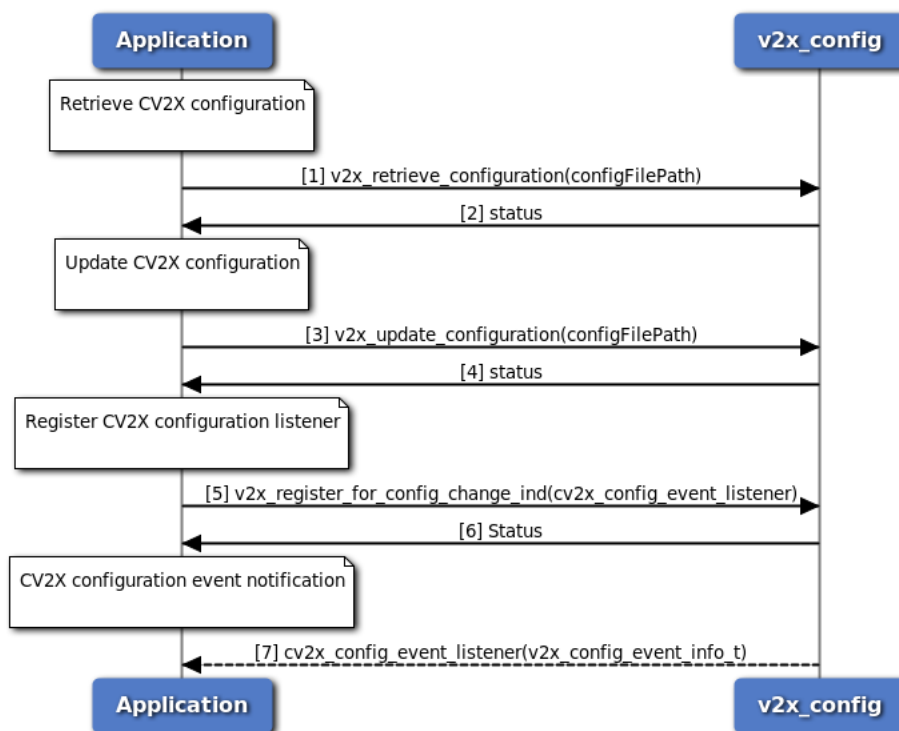

Figure 3-74 Retrieve/Update C-V2X Configuration Call Flow - C++ version

This call flow diagram describes the sequence of steps for retrieving or updating C-V2X configuration file using C++ version APIs.

1. Application requests for a ICv2xFactory instance.
2. Reference to singleton ICv2xFactory is returned to application.
3. Application requests C-V2X factory for a ICv2xConfig instance.
4. C-V2X factory creates ICv2xConfig object and calls init() method of ICv2xConfig.
5. C-V2X config starts initialization asynchronously.
6. C-V2X factory return ICv2xConfig object to application.
7. C-V2X factory is asynchronously notified of the readiness status of the C-V2X config via the initialization callback.
8. C-V2X factory calls application-supplied callback to notify the readiness status of C-V2X config (either SERVICE\_AVAILABLE or SERVICE\_FAILED). If the status is SERVICE\_AVAILABLE, application can then request to retrieve or update C-V2X configuration.
9. Application requests to retrieve C-V2X configuration by calling retrieveConfiguration and supplying it with a path for the storing of config XML file.
10. C-V2X config sends request to modem and waits for response asynchronously.
11. Application receives synchronous status.
12. Application is asynchronously notified of the status of the request (either SUCCESS or FAILED) via the application-supplied callback.
13. Application requests to update C-V2X configuration by calling updateConfiguration and supplying it with a path to the new config XML file.
14. C-V2X config sends request to modem and waits for response asynchronously.
15. Application receives synchronous status.
16. Application is asynchronously notified of the status of the request (either SUCCESS or FAILED) via the application-supplied callback.
17. Application registers ICv2xConfigListener to get notification of C-V2X configuration events if needed.
18. Application receives synchronous status.
19. Application gets notification of C-V2X configuration events if the C-V2X configuration being used in the system has been changed or expired.
20. Application deregisters ICv2xConfigListener to stop listening to C-V2X configuration events.
21. Application receives synchronous status.

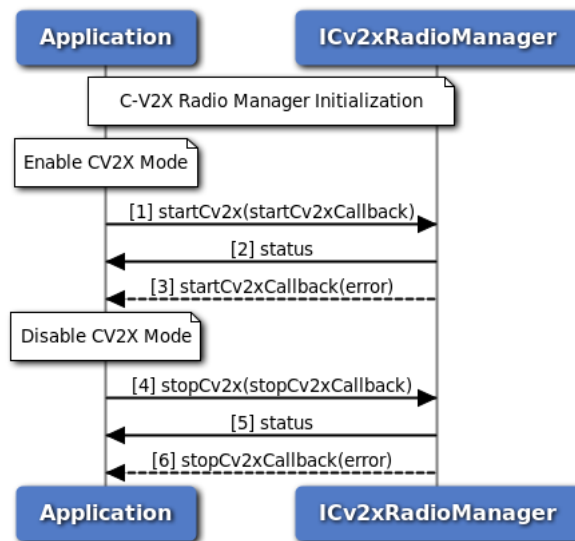

**Figure 3-75 Retrieve/Update C-V2X Configuration Call Flow - C Version**

This call flow diagram describes the sequence of steps for retrieving or updating C-V2X configuration file using C version APIs.

1. Application requests to retrieve C-V2X configuration by calling `v2x_retrieve_configuration` and supplying it with a path for the storing of config XML file.
2. Application receives synchronous status.
3. Application requests to update C-V2X configuration by calling `v2x_update_configuration` and supplying it with a path to the new config file.
4. Application receives synchronous status.
5. Application registers `cv2x_config_event_listener` to get notification of C-V2X configuration events if needed.
6. Application receives synchronous status.
7. Application gets notification of C-V2X configuration events if the C-V2X configuration being used in the system has been changed or expired.

### 3.5.2 Start/Stop C-V2X Mode



**Figure 3-76 Start/Stop C-V2X Mode Call Flow - C++ Version**

This call flow diagram describes the sequence of steps for starting or stopping C-V2X mode using C++ version APIs. Application must perform C-V2X radio manager initialization before calling any methods of ICv2xRadioManager. In normal operation, applications do not need to start or stop C-V2X mode. The system is configured by default to start C-V2X mode at boot. We include the call flow below for the sake of completeness.

1. Application requests to put modem into C-V2X mode using startCv2x method.
2. Application receives synchronous status which indicates if the start request was sent successfully.
3. Application is notified of the status of the start request (either SUCCESS or FAILED) via the application-supplied callback.
4. Application requests to disable C-V2X mode using stopCv2x method.
5. Application receives synchronous status which indicates if the stop request was sent successfully.
6. Application is asynchronously notified of the status of the stop request (either SUCCESS or FAILED) via the application-supplied callback.

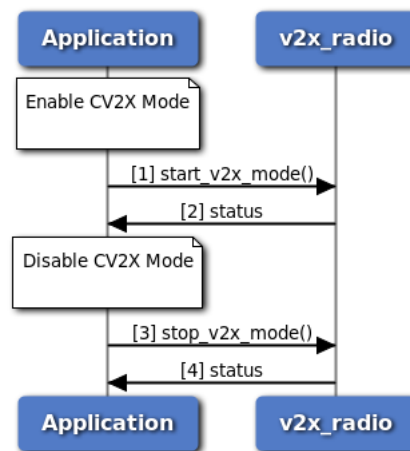

**Figure 3-77 Start/Stop C-V2X Mode Call Flow - C Version**

This call flow diagram describes the sequence of steps for starting or stopping C-V2X mode using C version APIs.

1. Application requests to put modem into C-V2X mode using `start_v2x_mode` method.
2. Application receives synchronous status which indicates if the operation was successful.
3. Application requests to disable C-V2X mode using `stop_v2x_mode` method.
4. Application receives synchronous status which indicates if the operation was successful.

### 3.5.3 C-V2X Radio Control Flow

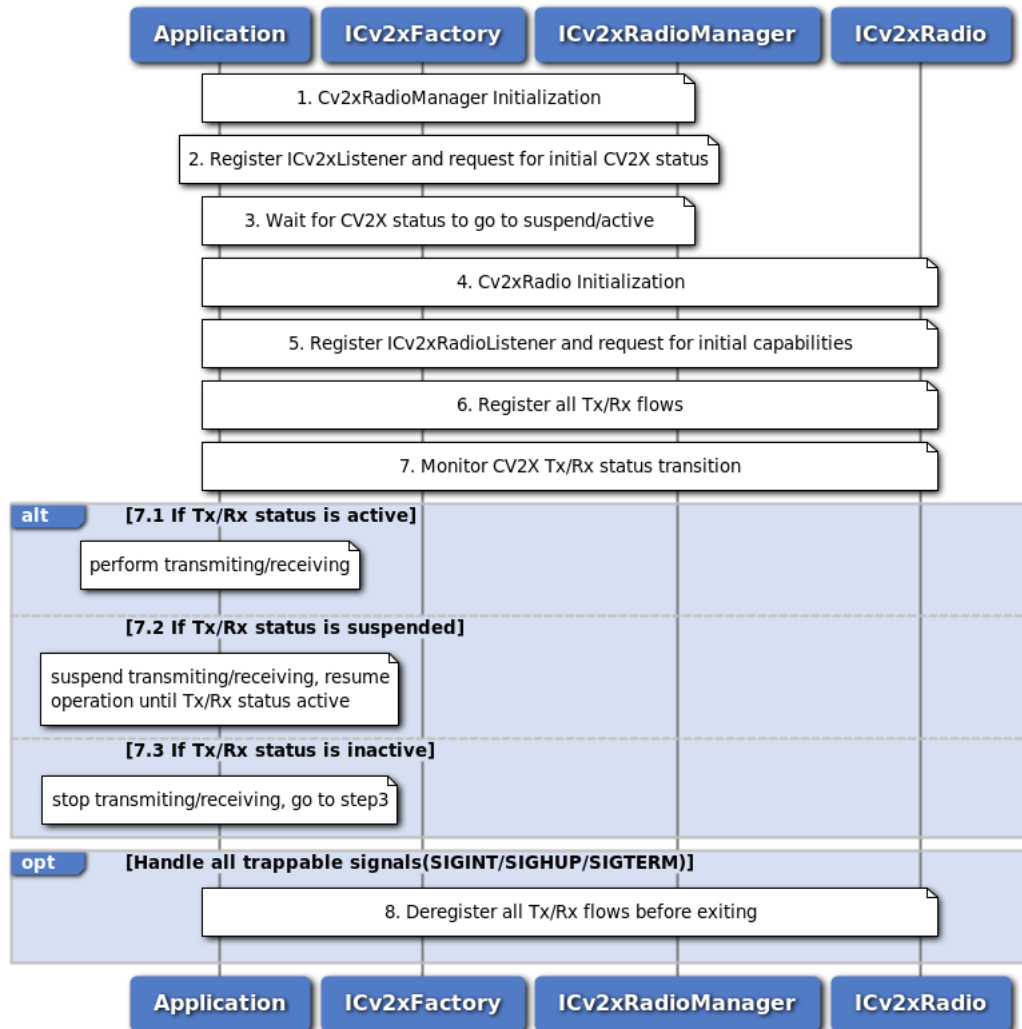

Figure 3-78 C-V2X Radio Control Flow - C++ Version

This call flow diagram describes the sequence of steps for overall C-V2X radio control flow using C++ version APIs.

1. Application performs C-V2X radio manager initialization and waits for the readiness. See steps 1~8 in [fig\\_cv2x\\_radio\\_initialization\\_callflow](#).
2. Application registers ICv2xListener to get C-V2X status update notification and requests for the initiate C-V2X status. See steps 1~6 in [fig\\_cv2x\\_get\\_status\\_callflow](#).
3. Application waits for C-V2X status to go to SUSPEND/ACTIVE.
4. Application performs C-V2X radio initialization and waits for the readiness. See steps 9~17 in [fig\\_cv2x\\_radio\\_initialization\\_callflow](#).
5. Application registers C-V2X radio listener to get C-V2X radio related notifications (L2 address update, SPS offset update, SPS scheduling update, C-V2X radio capabilities update) and requests for the initial C-V2X radio capabilities if needed. See steps 1~6 in [fig\\_cv2x\\_get\\_capabilities\\_callflow](#).

6. Application registers all Tx/Rx flows. See [fig\\_cv2x\\_radio\\_rx\\_sub\\_callflow/fig\\_cv2x\\_radio\\_event\\_flow\\_callflow/fig\\_cv2x\\_radio\\_sps\\_flow\\_callflow](#).
7. Application monitors C-V2X status change during operation.
  - 7.1 If C-V2X Tx/Rx status is active, application performs transmitting/receiving.
  - 7.2 If C-V2X Tx/Rx status goes to SUSPEND, application should suspend transmitting/receiving, log the event and resume operation when C-V2X Tx/Rx status goes to ACTIVE again.
  - 7.3 If C-V2X Tx/Rx status goes to INACTIVE, application should stop transmitting/receiving, log the event and go back to step 3 for recovery.
8. Application should handle all trappable signals like SIGINT/SIGHUP/SIGTERM, all Tx/Rx flows must be deregistered before exiting.

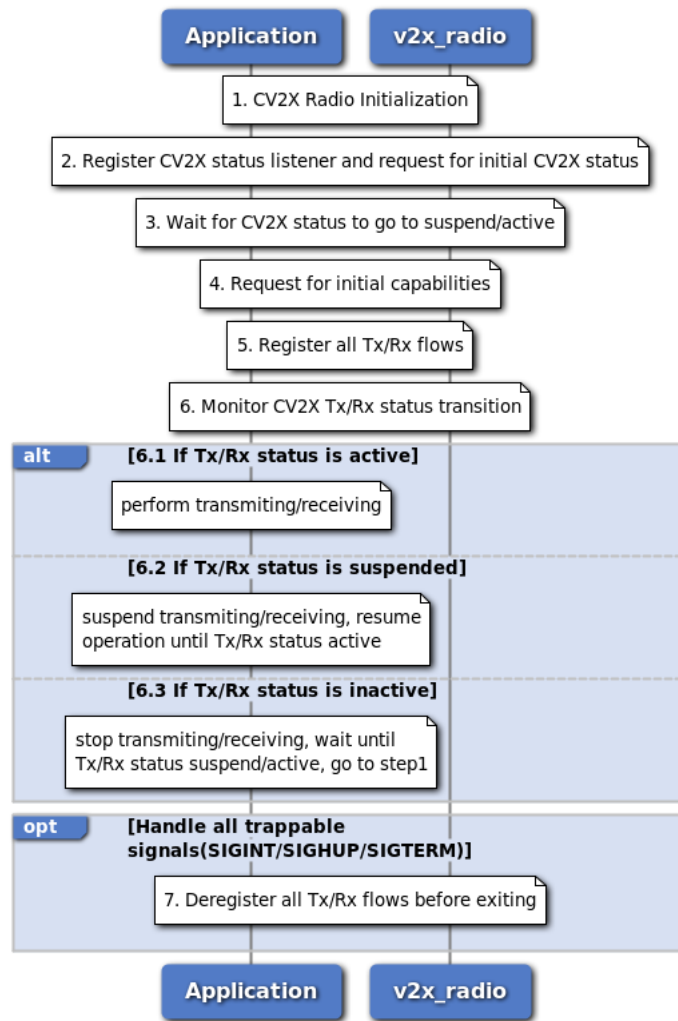

Figure 3-79 C-V2X Radio Control Flow - C Version

This call flow diagram describes the sequence of steps for overall C-V2X radio control flow using C version APIs.

1. Application performs C-V2X radio initialization and waits for the readiness in application provided



- callback. See [fig\\_cv2x\\_radio\\_initialization\\_callflow\\_c](#). Application should check the C-V2X radio initialization status, retry or exit if failing.
2. Application registers `v2x_ext_radio_status_listener` to get C-V2X status update notification and requests for the initiate C-V2X status. See steps 1~5 in [fig\\_cv2x\\_get\\_status\\_callflow\\_c](#).
  3. Application waits for C-V2X status to go to SUSPEND/ACTIVE.
  4. Application requests for the initial C-V2X radio capabilities if needed. See [fig\\_cv2x\\_get\\_capabilities\\_callflow\\_c](#).
  5. Application registers all Tx/Rx flows. See [fig\\_cv2x\\_radio\\_rx\\_sub\\_callflow\\_c](#)/[fig\\_cv2x\\_radio\\_↔event\\_flow\\_callflow\\_c](#)/[fig\\_cv2x\\_radio\\_sps\\_flow\\_callflow\\_c](#).
  6. Application monitors C-V2X status change during operation.
    - 6.1 If C-V2X Tx/Rx status is active, application performs transmitting/receiving.
    - 6.2 If C-V2X Tx/Rx status goes to SUSPEND, application should suspend transmitting/receiving, log the event and resume operation when C-V2X Tx/Rx status goes to ACTIVE again.
    - 6.3 If C-V2X Tx/Rx status goes to INACTIVE, application should stop transmitting/receiving, log the event, wait for C-V2X Tx/Rx status to go to SUSPEND or ACTIVE and then go back to step 1 for recovery.
  7. Application should handle all trappable signals like SIGINT/SIGHUP/SIGTERM, all Tx/Rx flows must be deregistered before exiting.

### 3.5.4 C-V2X Radio Initialization

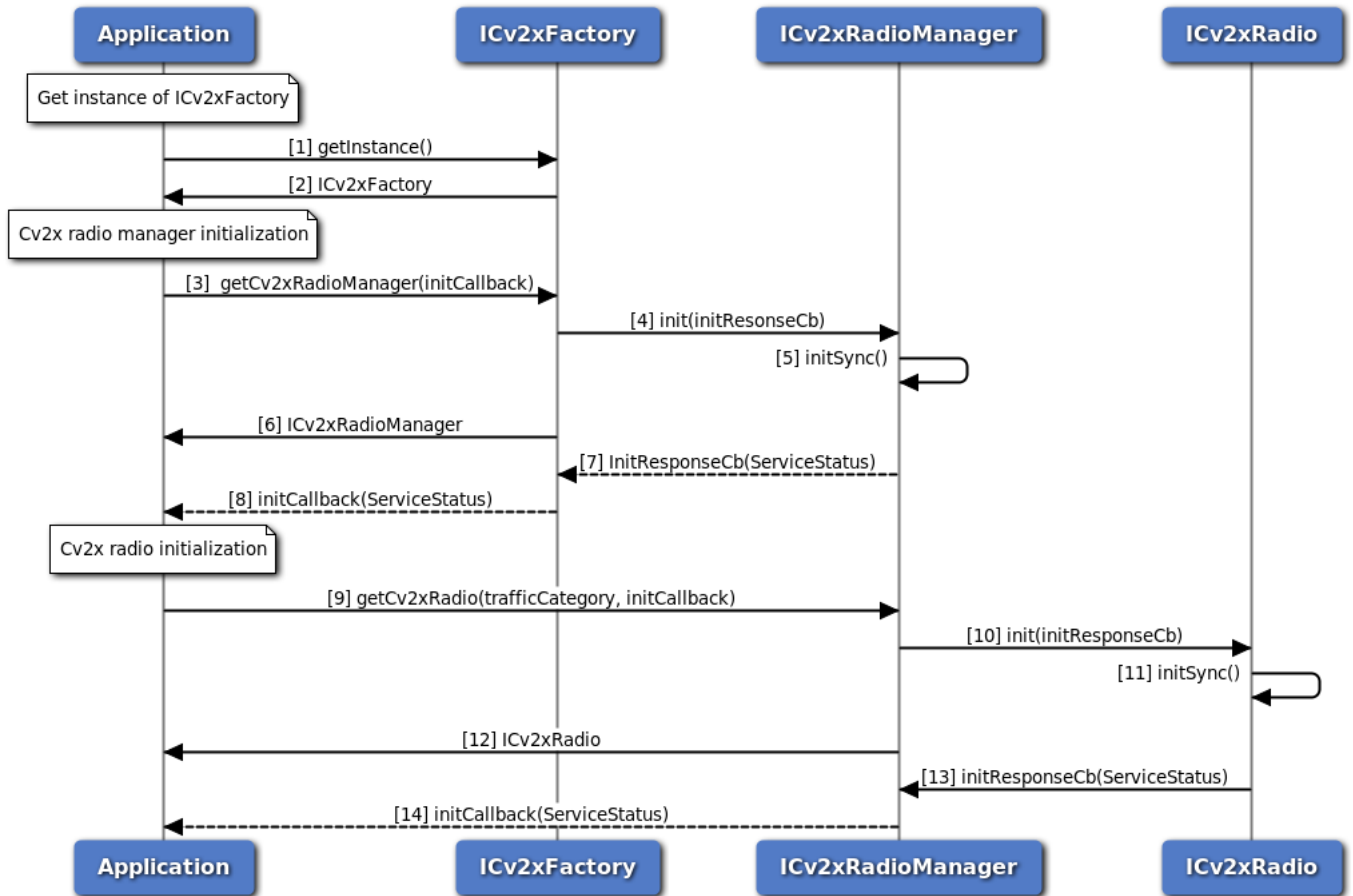
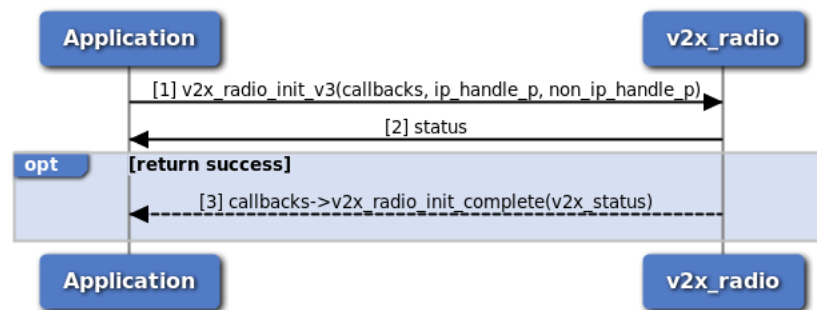

**Figure 3-80 C-V2X Radio Initialization Call Flow - C++ Version**

This call flow diagram describes the sequence of steps for initializing the ICv2xRadioManager and the ICv2xRadio object using C++ version APIs. Applications must initialize ICv2xRadioManager/ICv2xRadio object and wait for the readiness before calling any other methods on the objects.

1. Application requests for a ICv2xFactory instance.
2. Reference to singleton ICv2xFactory is returned to application.
3. Application requests C-V2X factory for an ICv2xRadioManager instance.
4. C-V2X factory creates ICv2xRadioManager object and calls init() method of ICv2xRadioManager.
5. C-V2X radio manager starts initialization asynchronously.
6. C-V2X factory returns ICv2xRadioManager object to application.
7. C-V2X factory is asynchronously notified of the readiness status of the C-V2X radio manager via the initialization callback.
8. C-V2X factory calls application-supplied callback to notify the readiness status of C-V2X radio manager (either SERVICE\_AVAILABLE or SERVICE\_FAILED).
9. Application requests C-V2X Radio from ICv2xRadioManager.

10. C-V2X radio manager creates ICv2xRadio object and calls method init().
11. C-V2X radio starts initialization asynchronously.
12. C-V2X radio manager returns ICv2xRadio object to application.
13. C-V2X radio manager is asynchronously notified of the readiness status of the C-V2X radio via the initialization callback.
14. C-V2X radio manager calls application-supplied callback to notify the readiness status of C-V2X radio (either SERVICE\_AVAILABLE or SERVICE\_FAILED).

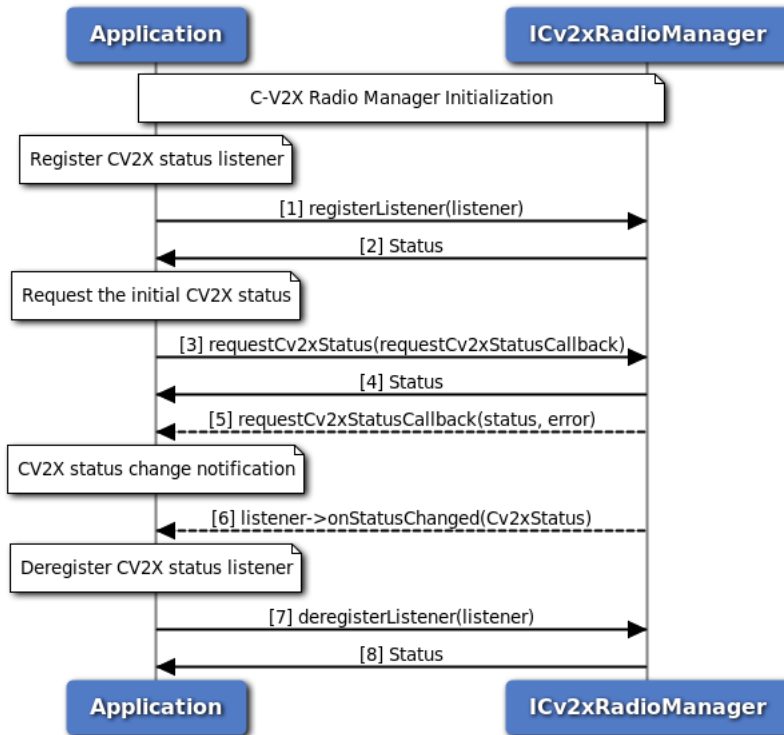

**Figure 3-81 C-V2X Radio Initialization Call Flow - C Version**

This call flow diagram describes the sequence of steps for initializing C-V2X radio using C version APIs. Applications must initialize C-V2X radio and wait for the readiness before calling any other methods of C-V2X radio.

1. Application calls `v2x_radio_init_v3` to initialize C-V2X radio manager and radio, provides callback functions as needed. Callback function `v2x_radio_init_complete` is mandatory for getting the C-V2X radio initialization status.
2. Application gets return value (0 on success or negative value on error). If the return value is success, the handles of C-V2X IP and non-IP radio interface are provided via the application-supplied pointers `ip_handle_p` and `non_ip_handle_p`. The interface handles can be used to specify IP or non-IP traffic type when registering C-V2X radio Tx/Rx flows.
3. Application gets the notification of C-V2X radio initialization status (`V2X_STATUS_SUCCESS` or `V2X_STATUS_FAIL`) via the application-supplied `v2x_radio_init_complete` callback function if the return value of `v2x_radio_init_v3` is successful.

### 3.5.5 Get C-V2X Status



**Figure 3-82 Get C-V2X Status Call Flow - C++ Version**

This call flow diagram describes the sequence of steps for getting C-V2X radio status using C++ version APIs. Application must perform C-V2X radio manager initialization before calling any methods of ICv2xRadioManager.

1. Application registers a listener for getting notifications of C-V2X status update.
2. Status of register listener (either SUCCESS or FAILED) will be returned to the application.
3. Application requests the initial C-V2X status using requestCv2xStatus method.
4. Application receives synchronous status (either SUCCESS or FAILED) which indicates if the request was sent successfully.
5. Application is asynchronously notified of the status of the request (either SUCCESS or FAILED) via the application-supplied callback. If success, current C-V2X status is supplied via callback.
6. Application gets notification of C-V2X status update via method onStatusChanged of ICv2xRadioListener.
7. Application deregister the listener.
8. Status of deregistering listener (either SUCCESS or FAILED) will be returned to the application.

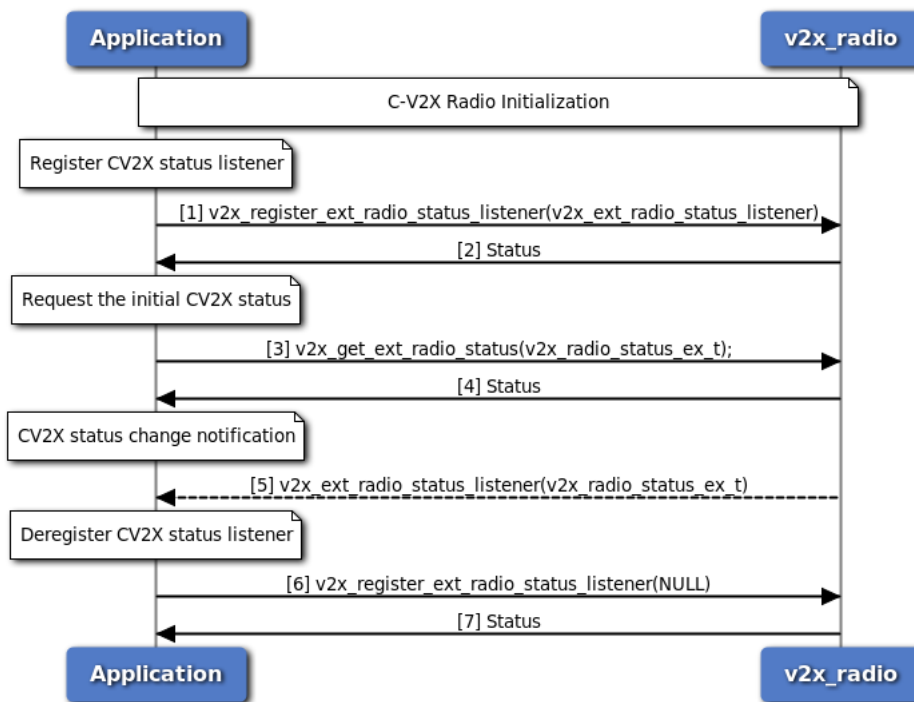
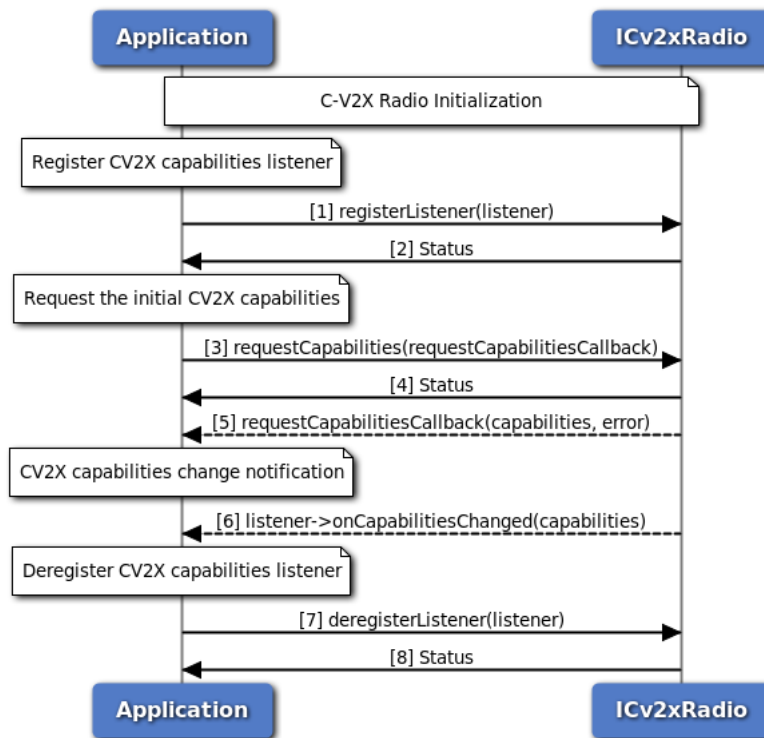

**Figure 3-83 Get C-V2X Status Call Flow - C Version**

This call flow diagram describes the sequence of steps for getting C-V2X radio status using C version APIs. Application must perform C-V2X radio initialization before calling any methods of C-V2X radio.

1. Application registers a listener for getting notifications of C-V2X status update.
2. Application gets the return value (V2X\_STATUS\_SUCCESS or V2X\_STATUS\_FAIL) which indicates if the operation was successfully performed. If it succeeded, the C-V2X overall status and per pool status are provided via the application-supplied pointer.
3. Application requests the initial C-V2X status using `v2x_get_ext_radio_status` method.
4. Application gets the return value (V2X\_STATUS\_SUCCESS or V2X\_STATUS\_FAIL) which indicates if the operation was successfully performed.
5. Application gets notification of C-V2X status update.
6. Application deregister the listener via setting a NULL listener.
7. Application gets the return value (V2X\_STATUS\_SUCCESS or V2X\_STATUS\_FAIL) which indicates if the operation was successfully performed.

### 3.5.6 Get C-V2X Capabilities



**Figure 3-84 Get C-V2X Capabilities Call Flow - C++ Version**

This call flow diagram describes the sequence of steps for getting C-V2X radio capabilities using C++ version APIs. Application must perform C-V2X radio initialization before calling any methods of ICv2xRadio.

1. Application registers a listener for getting notifications of C-V2X capabilities update.
2. Status of register listener (either SUCCESS or FAILED) will be returned to the application.
3. Application requests the initial C-V2X capabilities using requestCapabilities method.
4. Application receives synchronous status (either SUCCESS or FAILED) which indicates if the request was sent successfully.
5. Application is asynchronously notified of the status of the request (either SUCCESS or FAILED) via the application-supplied callback. If success, current C-V2X capabilities is supplied via callback.
6. Application gets notification of C-V2X capabilities update via method onCapabilitiesChanged of ICv2xRadioListener.
7. Application deregister the listener.
8. Status of deregistering listener (either SUCCESS or FAILED) will be returned to the application.

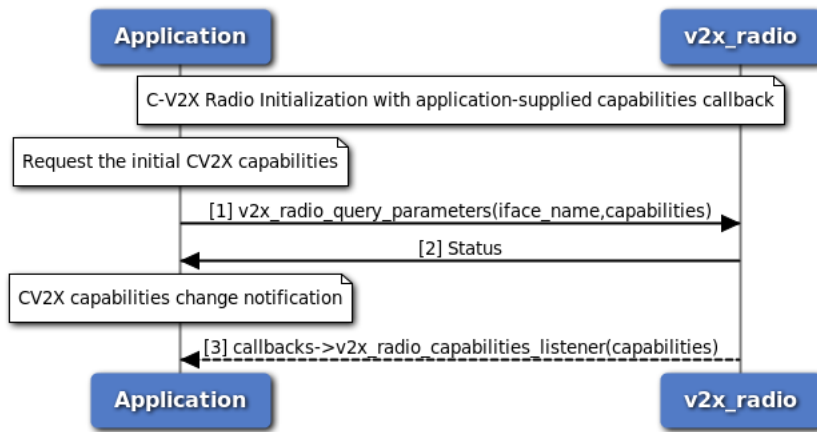

**Figure 3-85 Get C-V2X Capabilities Call Flow - C Version**

This call flow diagram describes the sequence of steps for getting C-V2X radio capabilities using C version APIs. Application must perform C-V2X radio initialization and provide C-V2X capabilities callback to get C-V2X radio capabilities update notification.

1. Application requests the initial C-V2X capabilities using `v2x_radio_query_parameters` method.
2. Application gets the return value (`V2X_STATUS_SUCCESS` or `V2X_STATUS_FAIL`) which indicates if the operation was successfully performed. If it succeeded, C-V2X capabilities are provided via the application-supplied pointer.
3. Application gets notification of C-V2X capabilities update via application-supplied callback `v2x_radio_capabilities_listener`.

### 3.5.7 C-V2X Radio RX Subscription

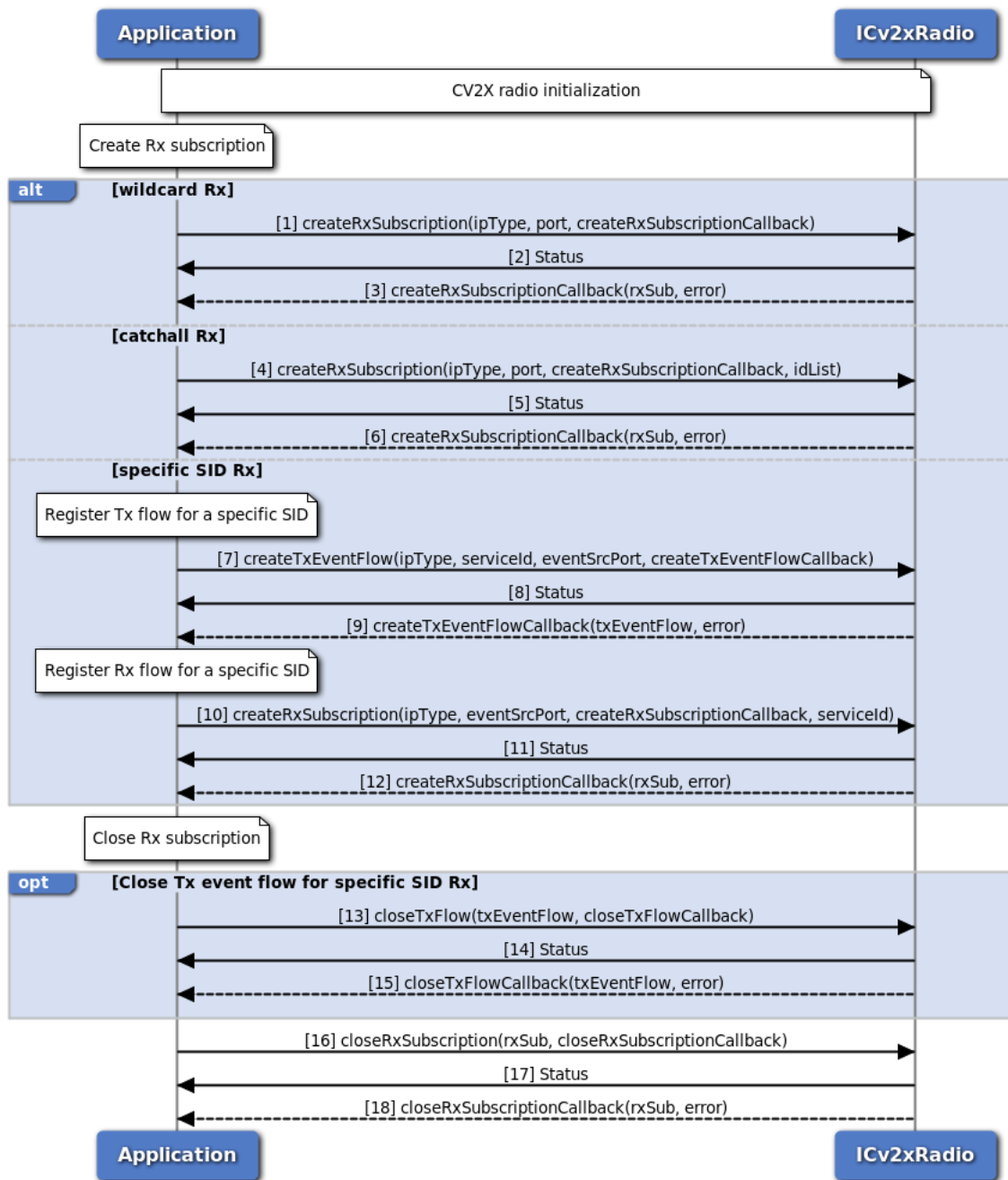

Figure 3-86 C-V2X Radio RX Subscription Call Flow - C++ Version

This call flow diagram describes the sequence of steps for registering or deregistering C-V2X Rx flows using C++ version APIs. Application must perform C-V2X radio initialization before calling any methods of ICv2xRadio.

There are three Rx modes supported for non-IP traffic,

- Wildcard Rx: Receive all service IDs on a single port. This mode could break catchall Rx and specific service ID Rx.



- Catchall Rx: Receive the specified service IDs on a single port. This mode can be used for Rx-only devices for which no Tx flow need to be created.
- Specific service ID Rx: Receive a specified service ID on a single port. Application can receive different service IDs on different ports by registering a pair of Tx and Rx flows for each service ID.

**NOTE:** For catchall or specific service ID Rx mode, filtering for received broadcast packets is implemented in low layer based on the service ID and its mapped destination L2 address, assuming that each service ID is mapped to a unique destination L2 address for all Tx and Rx devices. If this assumption is not valid, for example, in ETSI standards all broadcast service IDs are using same destination L2 address 0xFFFFFFFF, then application should choose wildcard Rx method and do filtering in application layer.

1. Application requests to enable wildcard Rx mode by specifying no service ID when creating Rx flow.
2. Application receives synchronous status (either SUCCESS or FAILED) indicating whether the request for creating Rx flow was sent successfully.
3. C-V2X radio sends asynchronous notification via the callback function on the status of the request for creating Rx flow. If SUCCESS, the RX flow is returned in the callback.
4. Application requests to enable catchall Rx mode by specifying a valid service ID list when creating Rx flow.
5. Application receives synchronous status (either SUCCESS or FAILED) indicating whether the request for creating Rx flow was sent successfully.
6. C-V2X radio sends asynchronous notification via the callback function on the status of the request for creating Rx flow. If SUCCESS, the RX flow is returned in the callback.
7. Application requests to create a Tx event flow before creating Rx flow to enable specific service ID Rx mode. The service ID and the port number of Tx and Rx flow should be the same.
8. Application receives synchronous status (either SUCCESS or FAILED) indicating whether the request for creating Tx flow was sent successfully.
9. C-V2X radio sends asynchronous notification via the callback function on the status of creating Tx flow. If SUCCESS, the TX event flow is returned in the callback.
10. Application requests to enable specific service ID Rx mode if the corresponding Tx flow has been registered successfully.
11. Application receives synchronous status (either SUCCESS or FAILED) indicating whether the request for creating Rx flow was sent successfully.
12. C-V2X radio sends asynchronous notification via the callback function on the status of the request for creating Rx flow. If SUCCESS, the RX flow is returned in the callback.
13. Application requests to closes the Tx event flow registered for specific service ID Rx mode.
14. Application receives synchronous status (either SUCCESS or FAILED) indicating whether the request for closing Tx flow was sent successfully.
15. C-V2X radio sends asynchronous notification via the callback function on the status of closing Tx flow.
16. Application requests to close the RX flow.
17. Application receives synchronous status (either SUCCESS or FAILED) indicating whether the request for closing Rx flow was sent successfully.
18. C-V2X radio sends asynchronous notification via the callback (if a callback was specified) indicating

the status of closing Rx flow.

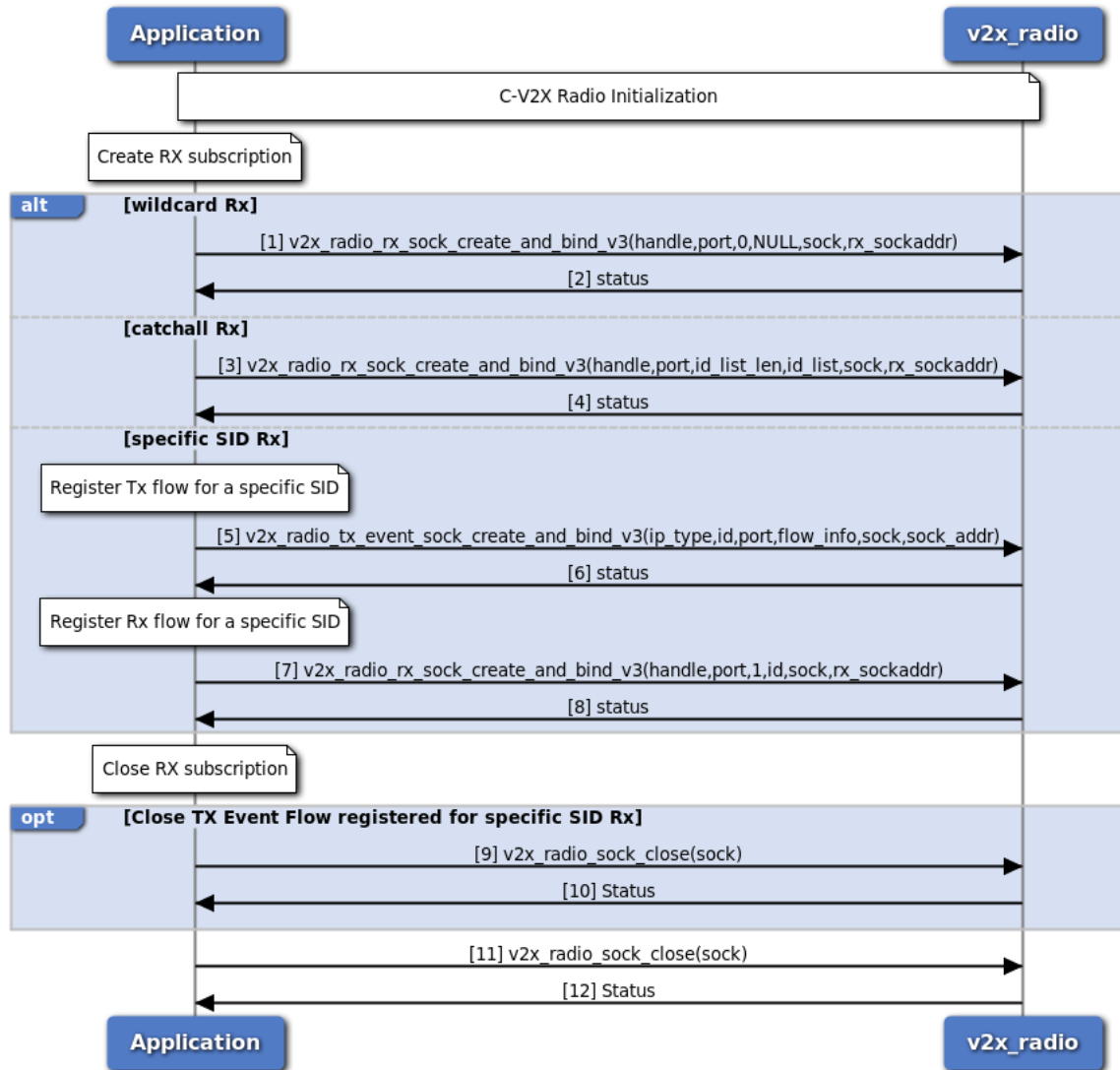

**Figure 3-87 C-V2X Radio RX Subscription Call Flow - C Version**

This call flow diagram describes the sequence of steps for registering or deregistering C-V2X Rx flows using C version APIs. Application must perform C-V2X radio initialization before calling any methods of C-V2X radio.

1. Application requests to enable wildcard Rx mode by specifying no service ID when creating Rx flow.
2. Application receives synchronous status (either 0 on SUCCESS or negative values if FAILED) indicating whether the Rx flow creation was successful.
3. Application requests to enable catchall Rx mode by specifying a valid service ID list when creating Rx flow.
4. Application receives synchronous status (either 0 on SUCCESS or negative values if FAILED) indicating whether the Rx flow creation was successful.
5. Application registers a Tx event flow before creating Rx flow to enable specific service ID Rx mode. The service ID and the port number of Tx and Rx flow should be the same.

6. Application receives synchronous status (either 0 on SUCCESS or negative values if FAILED) indicating whether the Tx event flow registration was successful.
7. Application requests to enable specific service ID Rx mode if the corresponding Tx flow has been registered successfully.
8. Application receives synchronous status (either 0 on SUCCESS or negative values if FAILED) indicating whether the Rx flow creation was successful.
9. Application requests to closes the Tx event flow registered for specific service ID Rx mode.
10. Application receives synchronous status (either 0 on SUCCESS or negative values if FAILED) indicating whether the Tx flow has been closed successfully.
11. Application requests to close the Rx flow.
12. Application receives synchronous status (either 0 on SUCCESS or negative values if FAILED) indicating whether the Rx flow has been closed successfully.

### 3.5.8 C-V2X Radio TX Event Flow

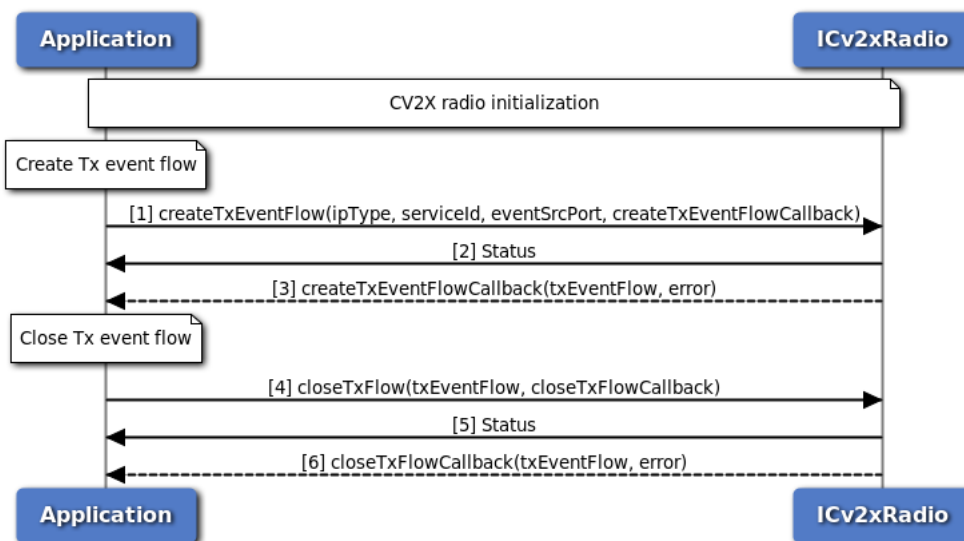
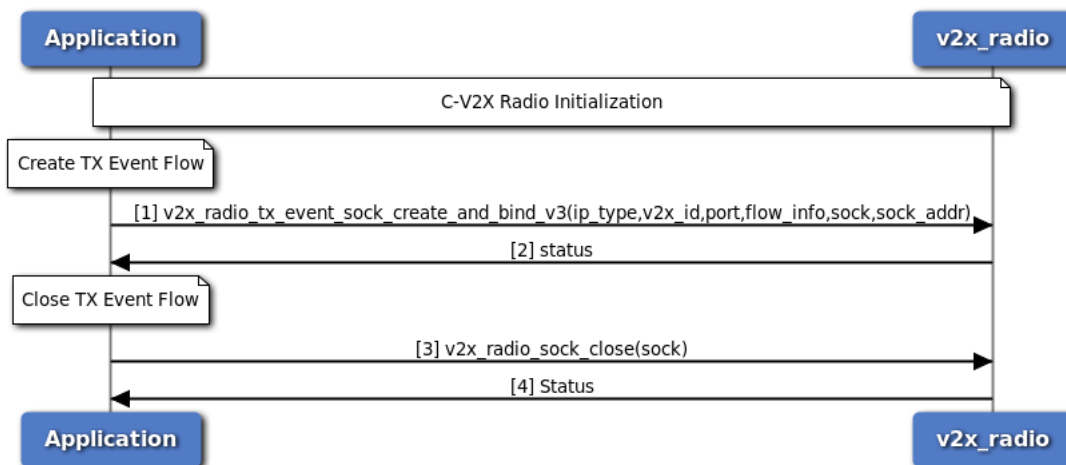

**Figure 3-88 C-V2X Radio TX Event Flow Call Flow - C++ Version**

This call flow diagram describes the sequence of steps for registering or deregistering C-V2X Tx event flows using C++ version APIs. Application must perform C-V2X radio initialization before calling any methods of ICv2xRadio.

1. Application requests a new TX event flow from the C-V2X radio using createTxEventFlow method.
2. Application receives synchronous status (either SUCCESS or FAILED) indicating whether the request was sent successfully.
3. C-V2X radio sends asynchronous notification via the callback function on the status of the request. If SUCCESS, the TX event flow is returned in the callback.
4. Application requests to close the TX event flow.
5. Application receives synchronous status (either SUCCESS or FAILED) indicating whether the request was sent successfully.

- C-V2X radio sends asynchronous notification via the callback (if a callback was specified) indicating the status of the request.

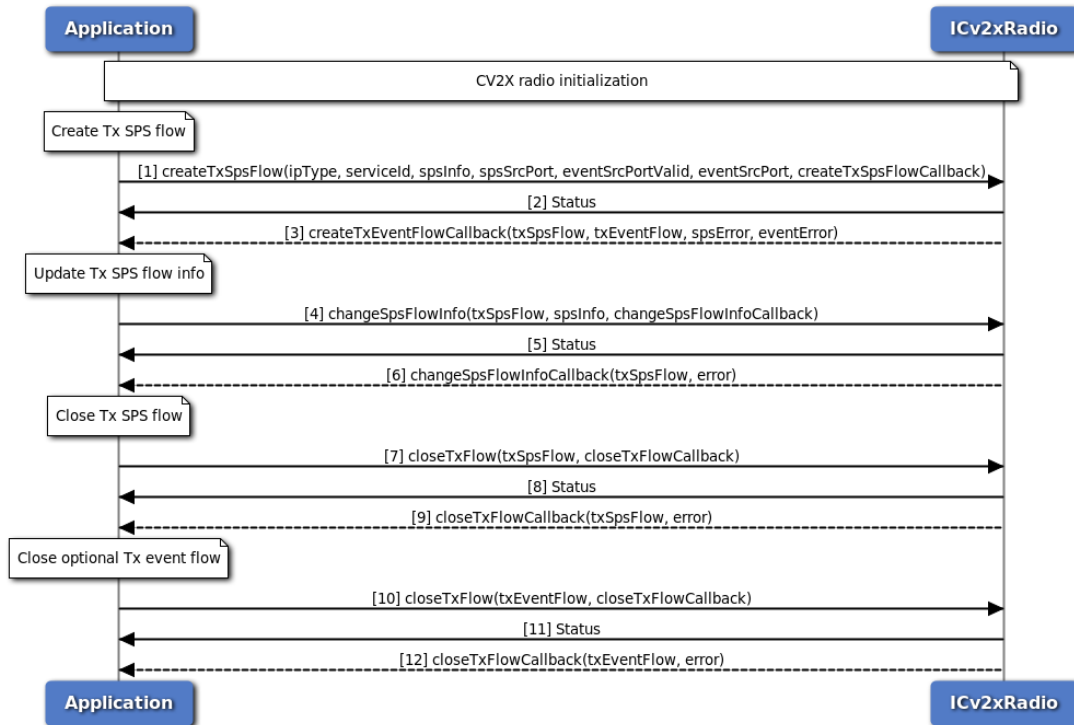

**Figure 3-89 C-V2X Radio TX Event Flow Call Flow - C++ Version**

This call flow diagram describes the sequence of steps for registering or deregistering C-V2X Tx event flows using C version APIs. Application must perform C-V2X radio initialization before calling any methods of C-V2X radio.

- Application requests a new TX event flow from the C-V2X radio using `v2x_radio_tx_event_sock_create_and_bind_v3` method and specifies the IP or non-IP traffic type, C-V2X service ID, port number, event flow information and pointers that that point to the created socket and socket address on success.
- Application receives synchronous status (either 0 on SUCCESS or negative values if FAILED) indicating whether the operation was successfully performed. If the return value is 0, application gets the socket value from the application-supplied pointer and then starts sending C-V2X data packets using the socket.
- Application requests to close the RX subscription by calling method `v2x_radio_sock_close` and supplying with a pointer that points to the TX socket created.
- Application receives synchronous status (either 0 on SUCCESS or negative values if FAILED) indicating whether the operation was successfully performed

### 3.5.9 C-V2X Radio TX SPS flow

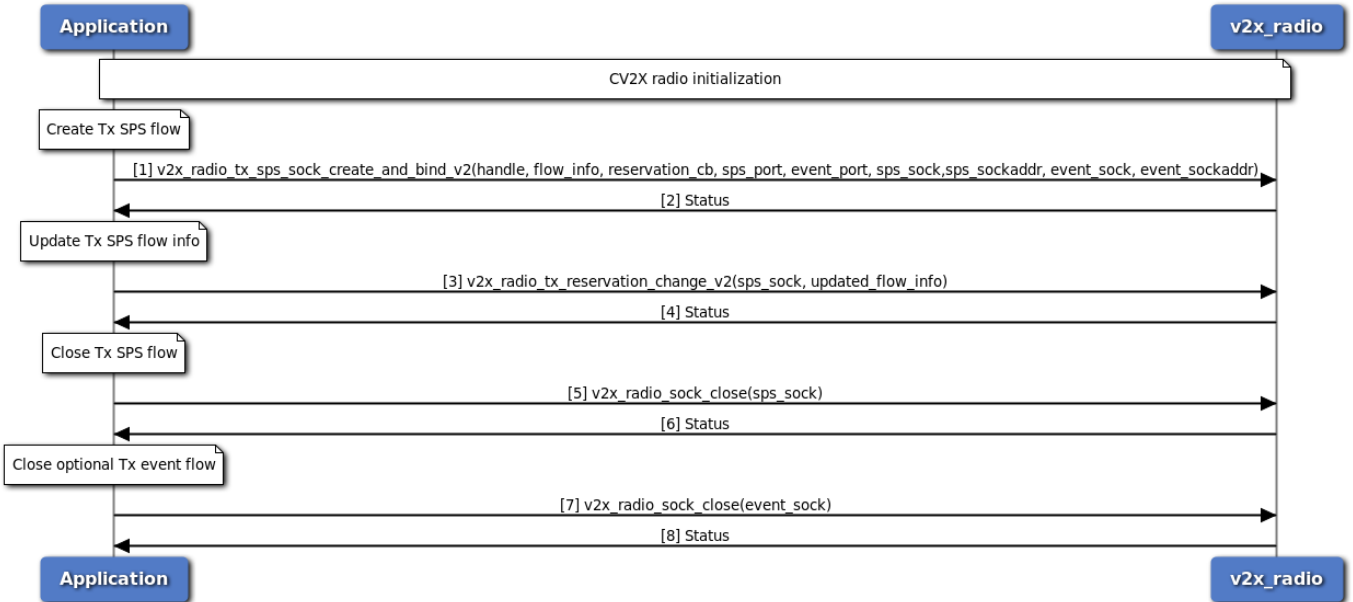

**Figure 3-90 C-V2X Radio SPS Flow Call Flow - C++ Version**

This call flow diagram describes the sequence of steps for registering or deregistering C-V2X Tx SPS flows using C++ version APIs. Application must perform C-V2X radio initialization before calling any methods of ICv2xRadio. Only 2 Tx SPS flows are allowed in maximum in the system.

1. Application requests a new TX SPS flow from the C-V2X radio using createTxSPSFlow method. The application can also specify an optional Tx event flow.
2. Application receives synchronous status (either SUCCESS or FAILED) indicating whether the request was sent successfully.
3. C-V2X radio sends asynchronous notification via the callback function. The callback will return the Tx SPS flow and its status as well as the optional Tx event flow and its status.
4. Application requests to change the SPS parameters using the changeSpsFlowInfo method.
5. Application received synchronous status (either SUCCESS or FAILED) indicating whether the request was sent successfully.
6. C-V2X radio sends asynchronous notification via the callback (if callback was specified) indicating the status of the request.
7. Application requests to close the SPS flow.
8. Application receives synchronous status (either SUCCESS or FAILED) indicating whether the request was sent successfully.
9. C-V2X radio sends asynchronous notification via the callback (if a callback was specified) indicating the status of the request.

10. Application requests to close optional Tx event flow (if one was created).
11. Application receives synchronous status (either SUCCESS or FAILED) indicating whether the request was sent successfully.
12. C-V2X radio sends asynchronous notification via the callback (if a callback was specified) indicating the status of the request.



**Figure 3-91 C-V2X Radio SPS Flow Call Flow - C Version**

This call flow diagram describes the sequence of steps for registering or deregistering C-V2X Tx SPS flows using C version APIs. Application must perform C-V2X radio initialization before calling any methods of C-V2X radio. Only 2 Tx SPS flows are allowed in maximum in the system.

1. Application requests a new TX SPS flow from the C-V2X radio using `v2x_radio_tx_sps_sock_create_and_bind_v2` method. The application can also specify an optional Tx event flow.
2. Application receives synchronous status (either 0 on SUCCESS or negative values if FAILED) indicating whether the sps flow was created successfully.
3. Application requests to change the SPS parameters using the `v2x_radio_tx_reservation_change_v2` method.
4. Application received synchronous status (either 0 on SUCCESS or negative values if FAILED) indicating whether the sps flow was updated successfully.
5. Application requests to close the SPS flow.
6. Application receives synchronous status (either 0 on SUCCESS or negative values if FAILED) indicating whether the sps flow was closed successfully.
7. Application requests to close optional Tx event flow (if one was created).
8. Application receives synchronous status (either 0 on SUCCESS or negative values if FAILED) indicating whether the event flow was closed successfully.

### 3.5.10 C-V2X Throttle Manager Filter rate adjustment notification flow

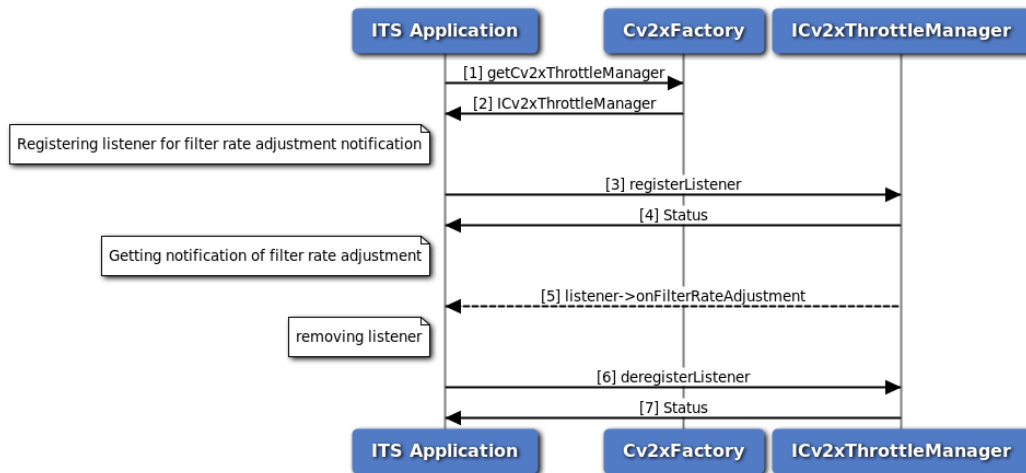

Figure 3-92 C-V2X Throttle Manager Filter Rate Adjustment Notification call flow

1. Application requests C-V2X factory for a C-V2X Throttle Manager.
2. C-V2X factory return ICv2xThrottleManager object to application.
3. Application register a listener for getting notifications of filter rate update.
4. Status of register listener i.e. either SUCCESS or FAILED will be returned to the application.
5. Application will get filter rate updates, positive value indicates to the application to filter more messages, and negative value indicates to the application to filter less messages
6. Application deregister the listener.
7. Status of deregistering listener, i.e. either SUCCESS or FAILED will be returned.

### 3.5.11 C-V2X Throttle Manager set verification load flow

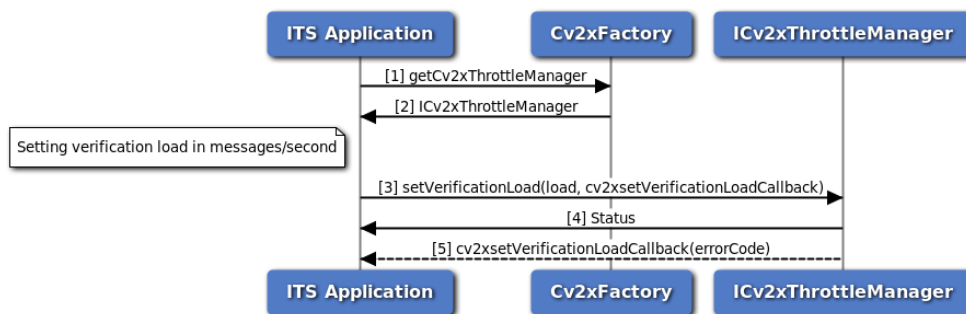

Figure 3-93 C-V2X Throttle Manager set verification call flow

1. Application requests C-V2X factory for a C-V2X Throttle Manager.
2. C-V2X factory return ICv2xThrottleManager object to application.
3. Application set verification load using setVerificationLoad method.

4. Application receives synchronous status which indicates if the request was sent successfully.
5. Application is notified of the status of the request (either SUCCESS or FAILED) via the application-supplied callback.

### 3.5.12 C-V2X TX Status Report

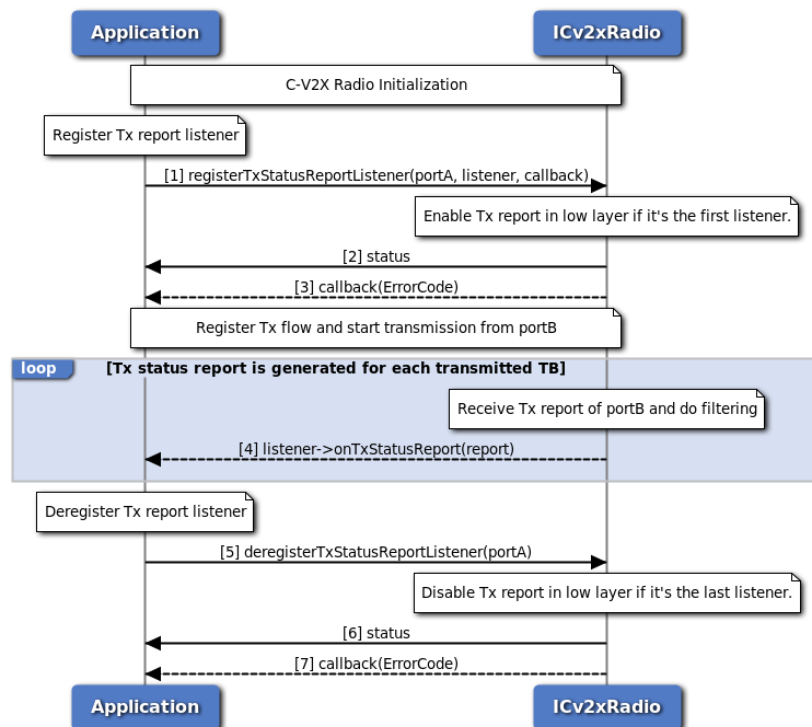

Figure 3-94 C-V2X TX Status Report Call Flow - C++ Version

This call flow diagram describes the sequence of steps for getting C-V2X Tx Status report per transport block using C++ version APIs. Application must perform C-V2X radio initialization before calling any methods of ICv2xRadio.

1. Application requests to register a listener for Tx status report, providing the interested port number(portA) of Tx status reports, the listener for receiving the reports and the callback function that used for notification of the result. C-V2X radio enables Tx status report in low layer if its the first request for registering Tx status report.
2. Application receives synchronous status (either SUCCESS or FAILED) indicating whether the request was sent successfully.
3. C-V2X radio sends asynchronous notification via the callback function indication the status of the request.
4. Tx status report is generated for each transport block transmitted, the portB included in Tx status report indicates which source port the specific transport block is sent from, it can be used to associate the Tx status report with a Tx SPS/Event flow. C-V2X radio filters received Tx status reports based on the port of the listener (portA) and the port included in Tx status report (portB):
  - If portA is 0, no filtering to the Tx status reports, application gets Tx status reports for all transport blocks.



- If portA is not 0 and it equals to portB, application only gets Tx status reports for transport blocks being sent from the specified port.
  - In other cases, Tx status reports are not sent to application.
5. Application deregister listener for Tx status report. If it is the last listener for Tx status report in the system, C-V2X radio disables Tx status report in low layer.
  6. Application receives synchronous status (either SUCCESS or FAILED) indicating whether the request was sent successfully.
  7. C-V2X radio sends asynchronous notification via the callback (if callback was specified) indicating the status of the request.

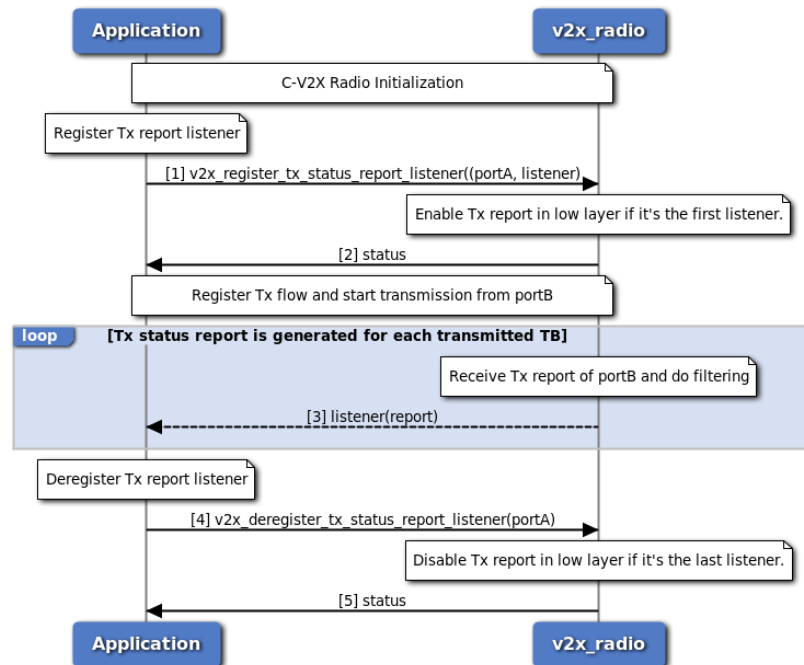

**Figure 3-95 C-V2X TX Status Report Call Flow - C Version**

This call flow diagram describes the sequence of steps for getting C-V2X Tx Status report per transport block using C version APIs. Application must perform C-V2X radio initialization before calling any methods of C-V2X radio.

1. Application requests to register a listener for Tx status report, providing the interested port number(portA) of Tx status reports and the listener for receiving the reports. C-V2X radio enables Tx status report in low layer if it is the first request for registering Tx status report.
2. Application receives synchronous status (either SUCCESS or FAILED) indicating whether the request was performed successfully.
3. Tx status report is generated for each transport block transmitted, the portB included in Tx status report indicates which source port the specific transport block is sent from, it can be used to associate the Tx status report with a Tx SPS/Event flow. C-V2X radio filters received Tx status reports based on the port of the listener (portA) and the port included in Tx status report (portB):
  - If portA is 0, no filtering to the Tx status reports, application gets Tx status reports for all transport blocks.

- If portA is not 0 and it equals to portB, application only gets Tx status reports for transport blocks being sent from the specified port.
  - In other cases, Tx status reports are not sent to application.
4. Application deregister listener for Tx status report. If it is the last listener for Tx status report in the system, C-V2X radio disables Tx status report in low layer.
  5. Application receives synchronous status (either SUCCESS or FAILED) indicating whether the request was performed successfully.

### 3.5.13 C-V2X RX Meta Data

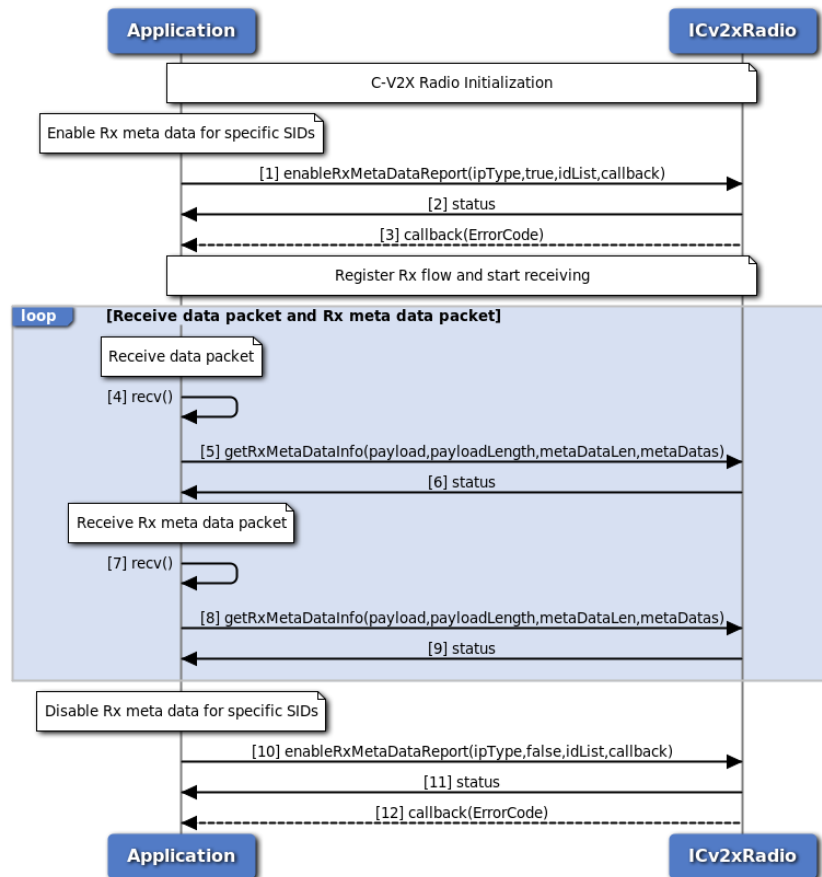

**Figure 3-96 C-V2X RX Meta Data Call Flow - C++ Version**

This call flow diagram describes the sequence of steps for enabling C-V2X Rx meta data per packet for non-IP traffic using C++ version APIs. Application must perform C-V2X radio initialization before calling any methods of ICv2xRadio.

1. Application requests to enable Rx meta data, providing the traffic type (only Non-IP is supported for Rx meta data), the interested service IDs and the callback function that used for notification of the result.
2. Application receives synchronous status (either SUCCESS or FAILED) indicating whether the request was sent successfully.
3. C-V2X radio sends asynchronous notification via the callback function indication the status of the

request.

4. After the enable of Rx meta data, application receives data packet which includes raw data along with SFN and subchannel index information via the Rx socket returned from Rx flow registration.
5. Application calls method `getRxMetaDataInfo` to get the raw data, SFN and subchannel index information from received data packet.
6. Application receives synchronous status (either SUCCESS or FAILED) indicating whether the data packet was parsed successfully.
7. Application receives Rx meta data packet via the Rx socket returned from Rx flow registration, one Rx meta data packet may include Rx meta data for multiple received data packets.
8. Application calls method `getRxMetaDataInfo` to get Rx meta data information from received Rx meta data packet. The information of SFN and subchannel index included in Rx meta data can be used to associate the Rx meta data with the received data packet.
9. Application receives synchronous status (either SUCCESS or FAILED) indicating whether the Rx meta data packet was parsed successfully.
10. Application requests to disable Rx meta data, providing the traffic type (only Non-IP is supported for Rx meta data), the registered service IDs and the callback function that used for notification of the result.
11. Application receives synchronous status (either SUCCESS or FAILED) indicating whether the request was sent successfully.
12. C-V2X radio sends asynchronous notification via the callback function indication the status of the request.

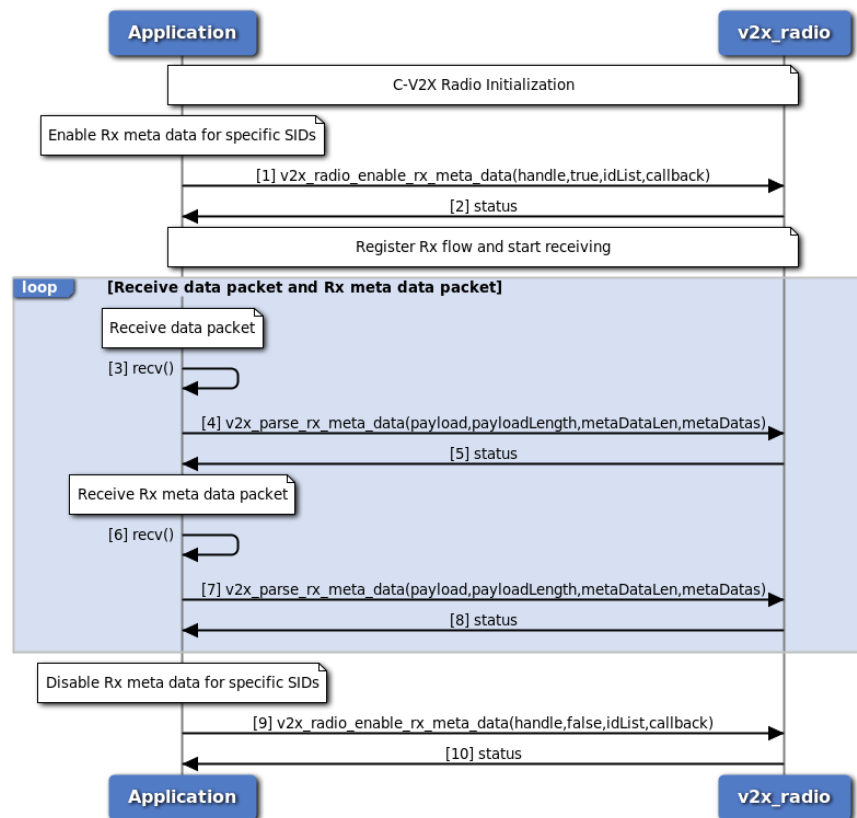

**Figure 3-97 C-V2X RX Meta Data Call Flow - C Version**

This call flow diagram describes the sequence of steps for enabling C-V2X Rx meta data per packet for non-IP traffic using C version APIs. Application must perform C-V2X radio initialization before calling any methods of C-V2X radio.

1. Application requests to enable Rx meta data, providing the traffic type (only Non-IP is supported for Rx meta data) and the interested service IDs.
2. Application receives synchronous status (either SUCCESS or FAILED) indicating whether the request was performed successfully.
3. After the enable of Rx meta data, application receives data packet which includes raw data along with SFN and subchannel index information via the Rx socket returned from Rx flow registration.
4. Application calls method `v2x_parse_rx_meta_data` to get the raw data, SFN and subchannel index information from received data packet.
5. Application receives synchronous status (either SUCCESS or FAILED) indicating whether the data packet was parsed successfully.
6. Application receives Rx meta data packet via the Rx socket returned from Rx flow registration, one Rx meta data packet may include Rx meta data for multiple received data packets.
7. Application calls method `v2x_parse_rx_meta_data` to get Rx meta data information from received Rx meta data packet. The information of SFN and subchannel index included in Rx meta data can be used to associate the Rx meta data with the received data packet.
8. Application receives synchronous status (either SUCCESS or FAILED) indicating whether the Rx meta data packet was parsed successfully.

9. Application requests to disable Rx meta data, providing the traffic type (only Non-IP is supported for Rx meta data), the registered service IDs and the callback function that used for notification of the result.
10. Application receives synchronous status (either SUCCESS or FAILED) indicating whether the request was performed successfully.

### 3.6 Audio

#### 3.6.1 Audio Manager API call flow

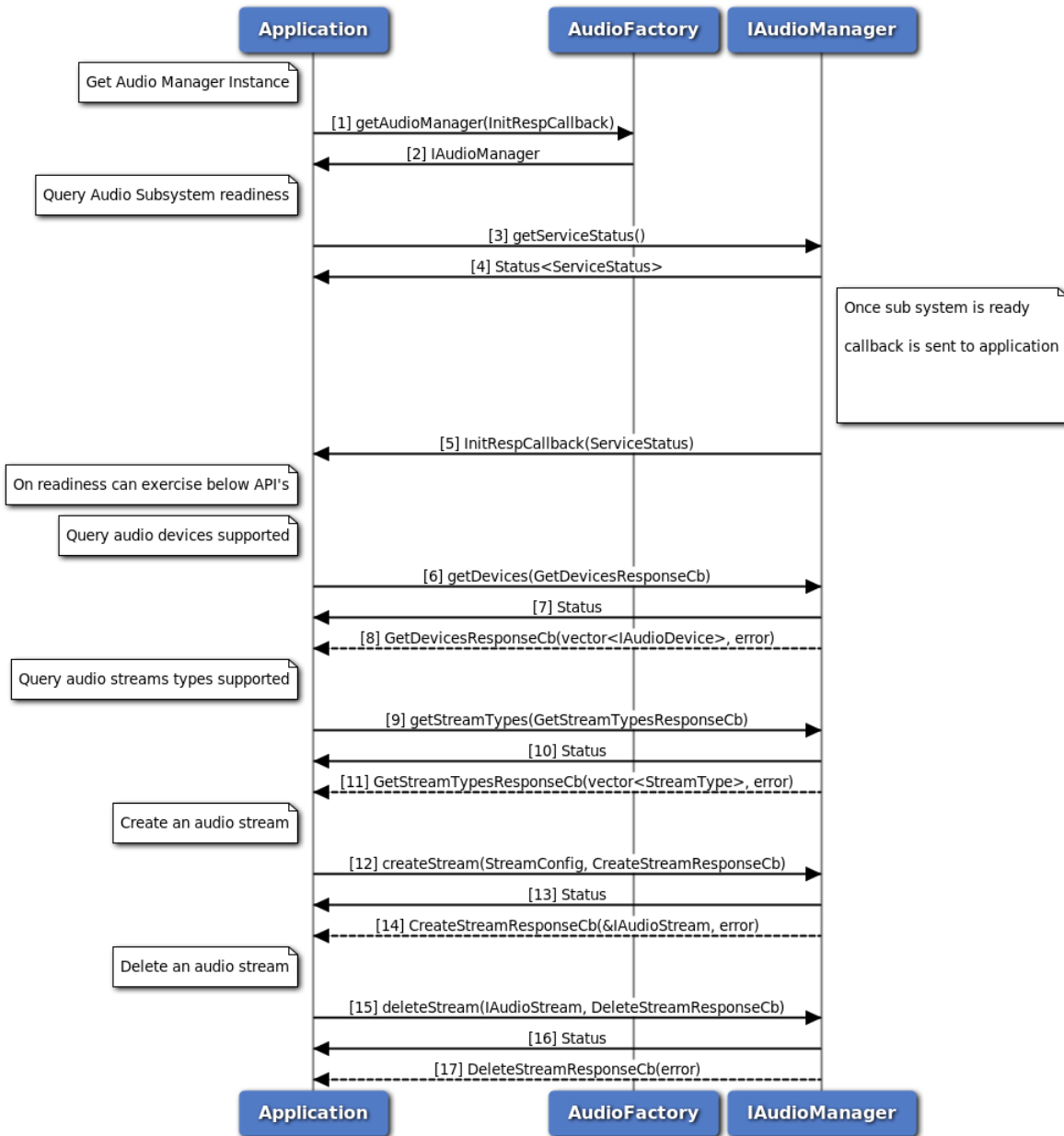
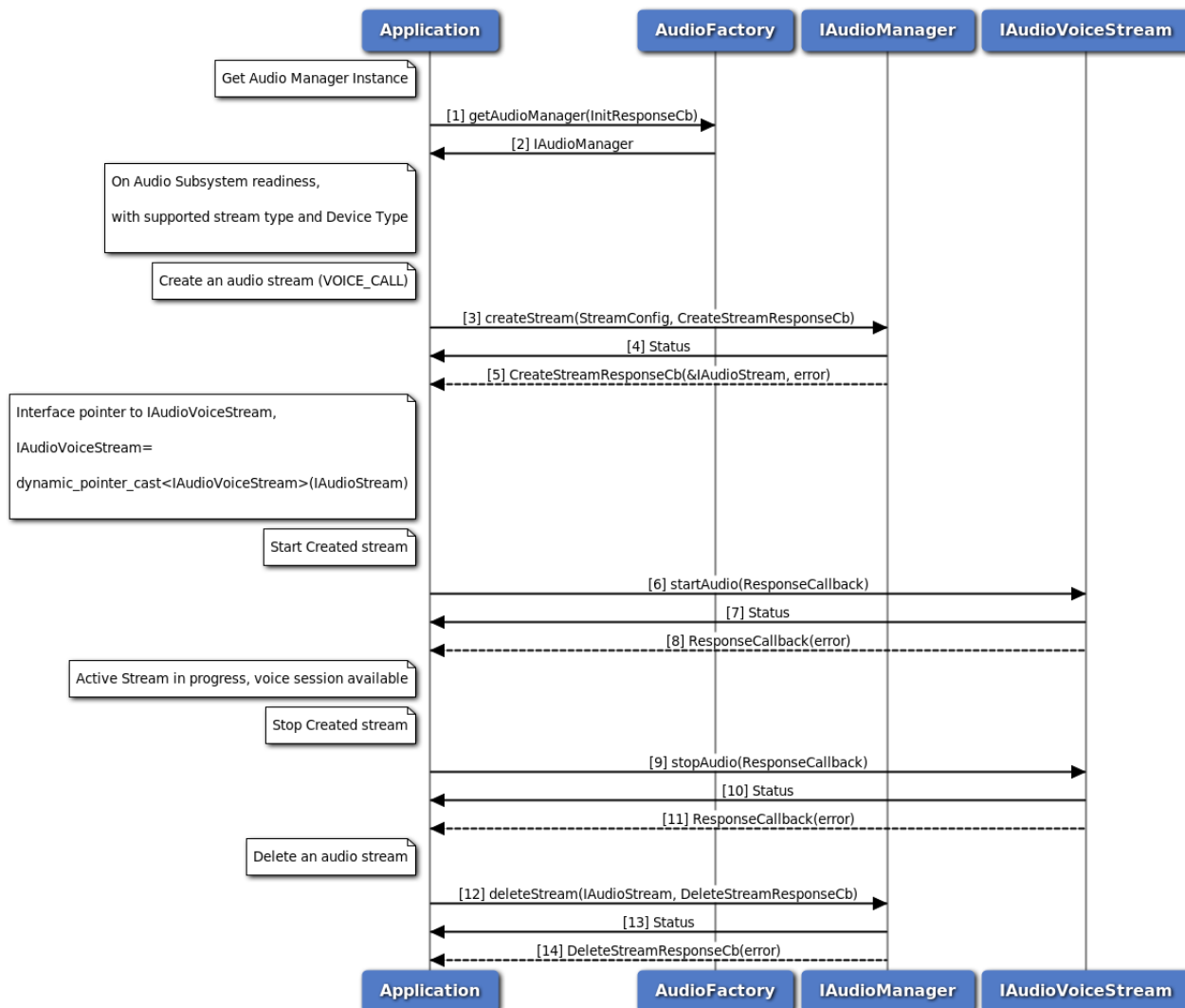

Figure 3-98 Audio Manager API call flow

1. Application requests Audio factory for an Audio Manager and passes callback pointer.
2. Audio factory return IAudioManager object to application.
3. Application can use IAudioManager::getServiceStatus to determine the state of sub system.
4. The application receives the ServiceStatus of sub system which indicates the state of service.
5. AudioManager notifies the application when the subsystem is ready through the callback mechanism.
6. On Readiness, Application requests supported device types using getDevices method.
7. Application receives synchronous Status which indicates if the getDevices request was sent successfully.
8. Application is notified of the Status of the getDevices request (either SUCCESS or FAILED) via the application-supplied callback, with array of supported device types.
9. Application requests supported stream types using getStreamTypes method.
10. Application receives synchronous Status which indicates if the getStreamTypes request was sent successfully.
11. Application is notified of the Status of the getStreamTypes request (either SUCCESS or FAILED) via the application-supplied callback, with array of supported stream types.
12. Application requests create audio stream using createStream method.
13. Application receives synchronous Status which indicates if the createStream request was sent successfully.
14. Application is notified of the Status of the createStream request (either SUCCESS or FAILED) via the application-supplied callback, with pointer to stream interface.
15. Application requests delete audio stream using deleteStream method.
16. Application receives synchronous Status which indicates if the deleteStream request was sent successfully.
17. Application is notified of the Status of the deleteStream request (either SUCCESS or FAILED) via the application-supplied callback.

### 3.6.2 Audio Voice Call Start/Stop call flow



**Figure 3-99 Audio Voice Call Start/Stop call flow**

1. Application requests Audio factory for an Audio Manager.
2. Audio factory return IAudioManager object to application.
3. On Readiness, Application requests create audio voice stream using createStream method with streamType as VOICE\_CALL.
4. Application receives synchronous Status which indicates if the createStream request was sent successfully.
5. Application is notified of the Status of the createStream request (either SUCCESS or FAILED) via the application-supplied callback, with pointer to stream interface referring to IAudioVoiceStream.
6. Application requests start audio stream using startAudio method on IAudioVoiceStream.
7. Application receives synchronous Status which indicates if the startAudio request was sent successfully.

8. Application is notified of the Status of the startAudio request (either SUCCESS or FAILED) via the application-supplied callback.
9. Application requests stop audio stream using stopAudio method on IAudioVoiceStream.
10. Application receives synchronous Status which indicates if the stopAudio request was sent successfully.
11. Application is notified of the Status of the stopAudio request (either SUCCESS or FAILED) via the application-supplied callback.
12. Application requests delete audio stream using deleteStream method.
13. Application receives synchronous Status which indicates if the deleteStream request was sent successfully.
14. Application is notified of the Status of the deleteStream request (either SUCCESS or FAILED) via the application-supplied callback.



### 3.6.3 Audio Voice Call Device Switch call flow

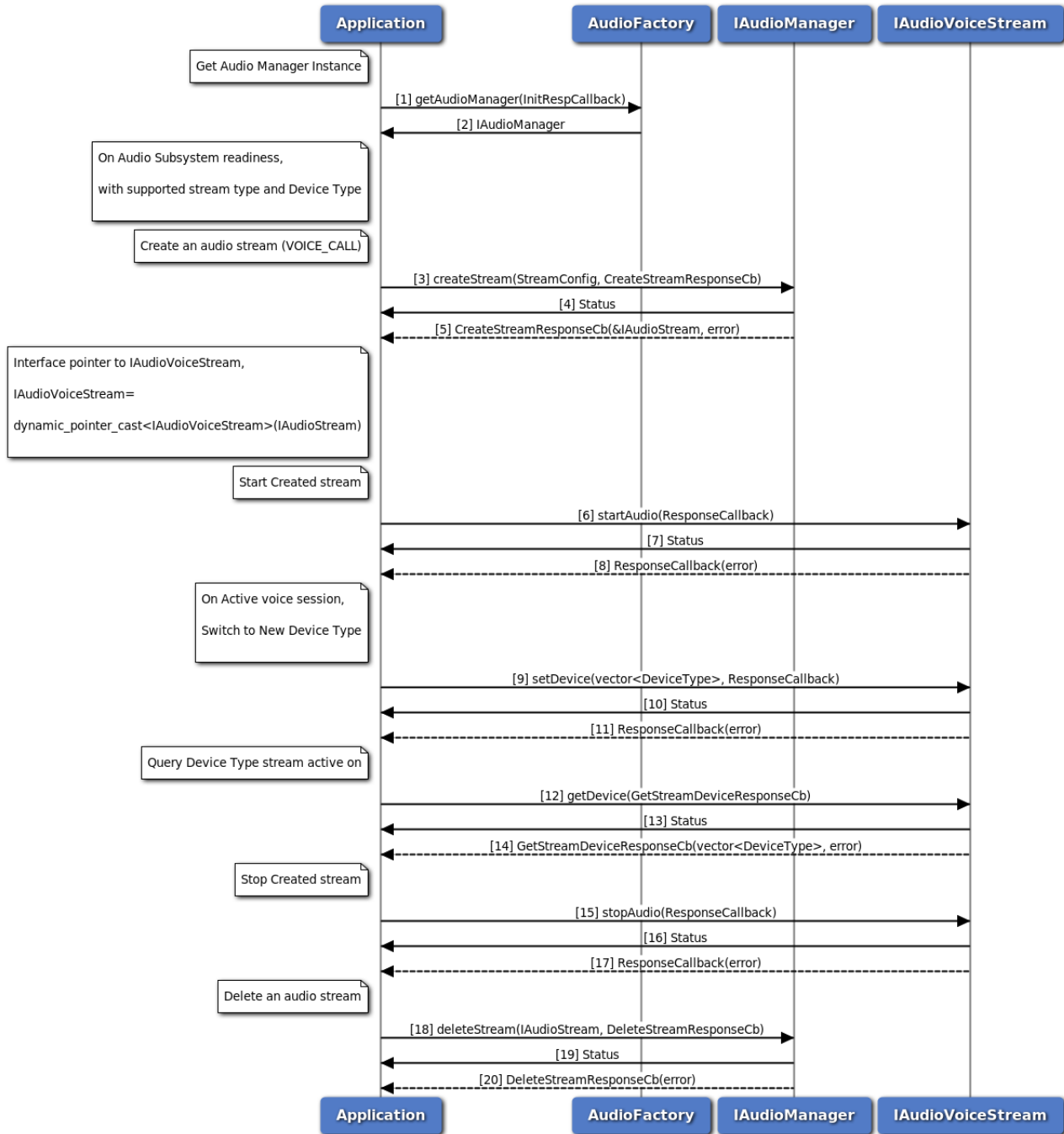

Figure 3-100 Audio Voice Call Device Switch call flow

1. Application requests Audio factory for an Audio Manager.
2. Audio factory return IAudioManager object to application.
3. On Readiness, Application requests create audio voice stream using createStream method with streamType as VOICE\_CALL.

4. Application receives synchronous Status which indicates if the createStream request was sent successfully.
5. Application is notified of the Status of the createStream request (either SUCCESS or FAILED) via the application-supplied callback, with pointer to stream interface referring to IAudioVoiceStream.
6. Application requests start audio stream using startAudio method on IAudioVoiceStream.
7. Application receives synchronous Status which indicates if the startAudio request was sent successfully.
8. Application is notified of the Status of the startAudio request (either SUCCESS or FAILED) via the application-supplied callback.
9. Application requests new device routing of stream using setDevice method on IAudioVoiceStream.
10. Application receives synchronous Status which indicates if the setDevice request was sent successfully.
11. Application is notified of the Status of the setDevice request (either SUCCESS or FAILED) via the application-supplied callback.
12. Application query device stream routed to using getDevice method on IAudioVoiceStream.
13. Application receives synchronous Status which indicates if the getDevice request was sent successfully.
14. Application is notified of the Status of the getDevice request (either SUCCESS or FAILED) via the application-supplied callback, along with device types.
15. Application requests stop audio stream using stopAudio method on IAudioVoiceStream.
16. Application receives synchronous Status which indicates if the stopAudio request was sent successfully.
17. Application is notified of the Status of the stopAudio request (either SUCCESS or FAILED) via the application-supplied callback.
18. Application requests delete audio stream using deleteStream method.
19. Application receives synchronous Status which indicates if the deleteStream request was sent successfully.
20. Application is notified of the Status of the deleteStream request (either SUCCESS or FAILED) via the application-supplied callback.

### 3.6.4 Audio Voice Call Volume/Mute control call flow

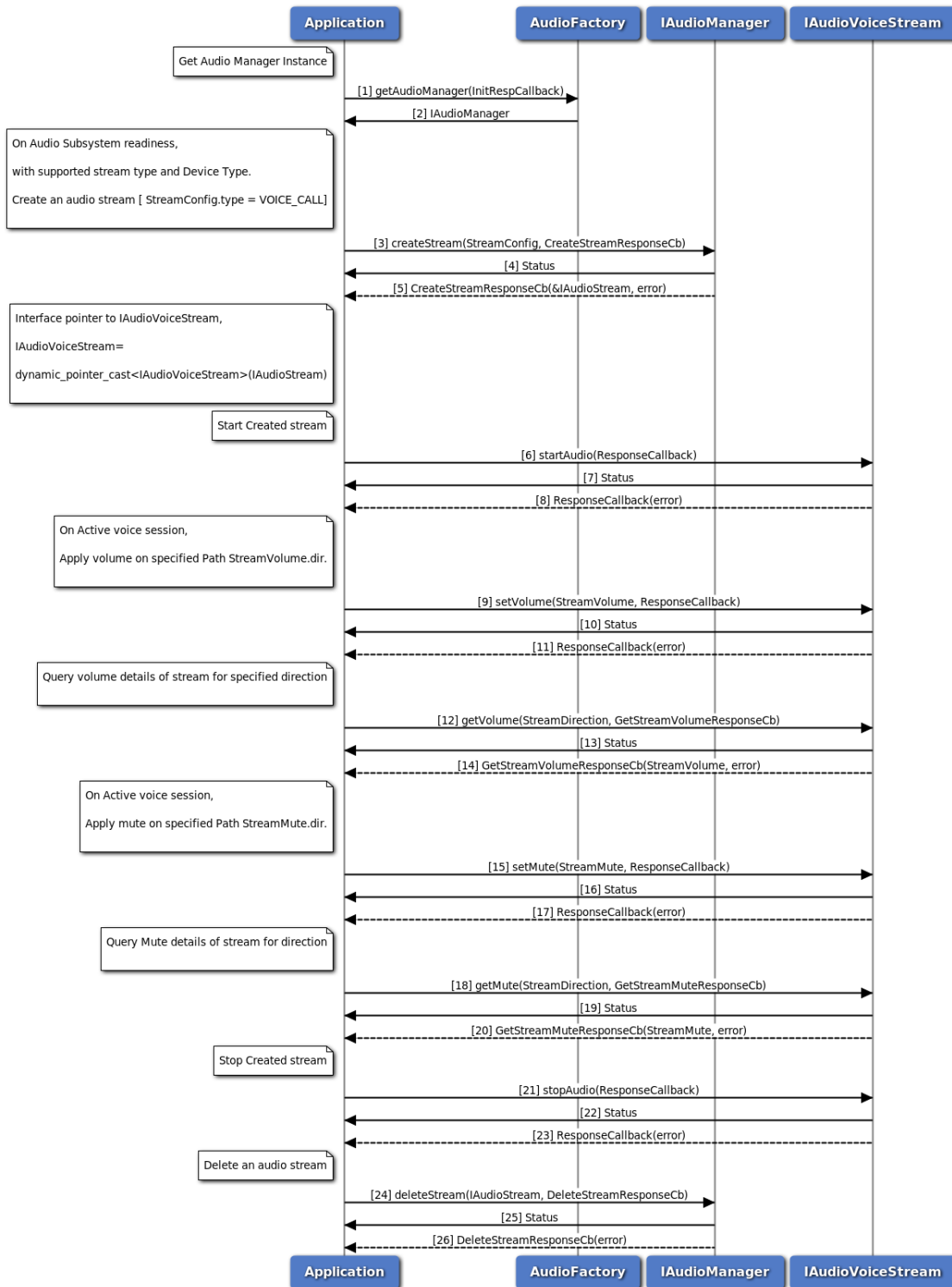

Figure 3-101 Audio Voice Call Volume/Mute control call flow

1. Application requests Audio factory for an Audio Manager.
2. Audio factory return IAudioManager object to application.

3. On Readiness, Application requests create audio voice stream using createStream method with streamType as VOICE\_CALL.
4. Application receives synchronous Status which indicates if the createStream request was sent successfully.
5. Application is notified of the Status of the createStream request (either SUCCESS or FAILED) via the application-supplied callback, with pointer to stream interface referring to IAudioVoiceStream.
6. Application requests start audio stream using startAudio method on IAudioVoiceStream.
7. Application receives synchronous Status which indicates if the startAudio request was sent successfully.
8. Application is notified of the Status of the startAudio request (either SUCCESS or FAILED) via the application-supplied callback.
9. Application requests new volume on stream using setVolume method on IAudioVoiceStream for specified direction.
10. Application receives synchronous Status which indicates if the setVolume request was sent successfully.
11. Application is notified of the Status of the setVolume request (either SUCCESS or FAILED) via the application-supplied callback.
12. Application query volume on stream using getVolume method on IAudioVoiceStream for specified direction.
13. Application receives synchronous Status which indicates if the getVolume request was sent successfully.
14. Application is notified of the Status of the getVolume request (either SUCCESS or FAILED) via the application-supplied callback for specified direction with volume details.
15. Application requests new mute on stream using setMute method on IAudioVoiceStream for specified direction.
16. Application receives synchronous Status which indicates if the setMute request was sent successfully.
17. Application is notified of the Status of the setMute request (either SUCCESS or FAILED) via the application-supplied callback.
18. Application query mute details on stream using getMute method on IAudioVoiceStream for specified direction.
19. Application receives synchronous Status which indicates if the getMute request was sent successfully.
20. Application is notified of the Status of the getMute request (either SUCCESS or FAILED) via the application-supplied callback for specified direction with mute details.
21. Application requests stop audio stream using stopAudio method on IAudioVoiceStream.
22. Application receives synchronous Status which indicates if the stopAudio request was sent successfully.
23. Application is notified of the Status of the stopAudio request (either SUCCESS or FAILED) via the application-supplied callback.
24. Application requests delete audio stream using deleteStream method.
25. Application receives synchronous Status which indicates if the deleteStream request was sent

successfully.

26. Application is notified of the Status of the deleteStream request (either SUCCESS or FAILED) via the application-supplied callback.

### 3.6.5 Call flow to play DTMF tone

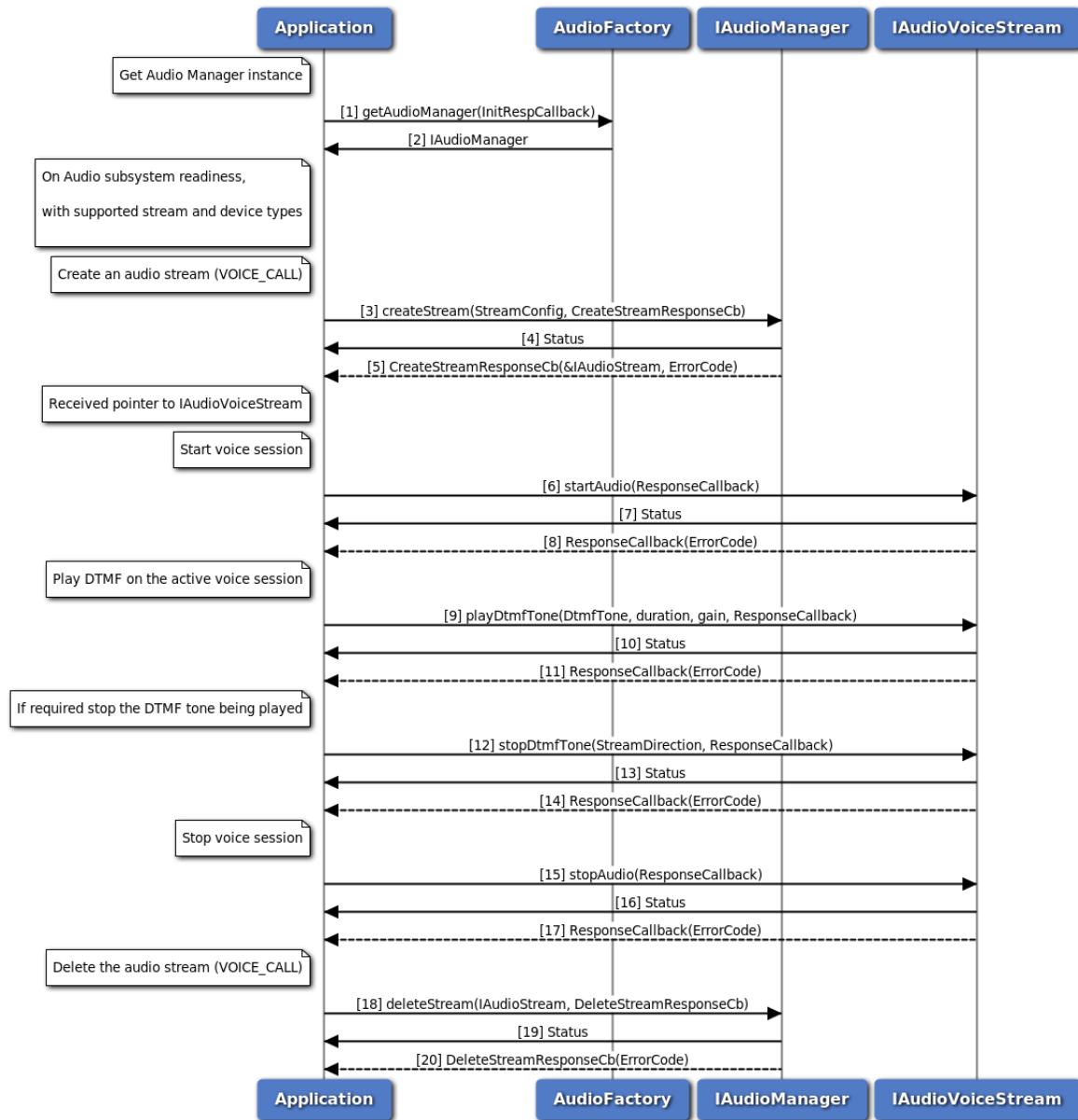

Figure 3-102 Call flow to play DTMF tone

1. Application requests Audio factory for an Audio Manager.
2. Audio factory return IAudioManager object to application.
3. On Readiness, Application requests to create a voice stream with streamType as VOICE\_CALL.
4. Application receives synchronous status which indicates if the createStream request was sent

- successfully.
5. Application is notified of the createStream request status (either SUCCESS or FAILED) via the application-supplied callback, with pointer to stream interface referring to IAudioVoiceStream.
  6. Application requests to start voice session using startAudio method on IAudioVoiceStream.
  7. Application receives synchronous status which indicates if the startAudio request was sent successfully.
  8. Application is notified of the startAudio request status (either SUCCESS or FAILED) via the application-supplied callback.
  9. Application requests to play a DTMF tone associated with the voice session
  10. Application receives synchronous status which indicates if the playDtmfTone request was sent successfully.
  11. Application is notified of the playDtmfTone request status (either SUCCESS or FAILED) via the application-supplied callback.
  12. Application can optionally stop the DTMF tone being played, before its duration expires.
  13. Application receives synchronous status which indicates if the stopDtmfTone request was sent successfully.
  14. Application is notified of the stopDtmfTone request status (either SUCCESS or FAILED) via the application-supplied callback.
  15. Application requests to stop the voice session using stopAudio method on IAudioVoiceStream.
  16. Application receives synchronous Status which indicates if the stopAudio request was sent successfully.
  17. Application is notified of the stopAudio request status(either SUCCESS or FAILED) via the application-supplied callback.
  18. Application requests delete audio stream using deleteStream method.
  19. Application receives synchronous Status which indicates if the deleteStream request was sent successfully.
  20. Application is notified of the deleteStream request status(either SUCCESS or FAILED) via the application-supplied callback.

### 3.6.6 Call flow to detect DTMF tones

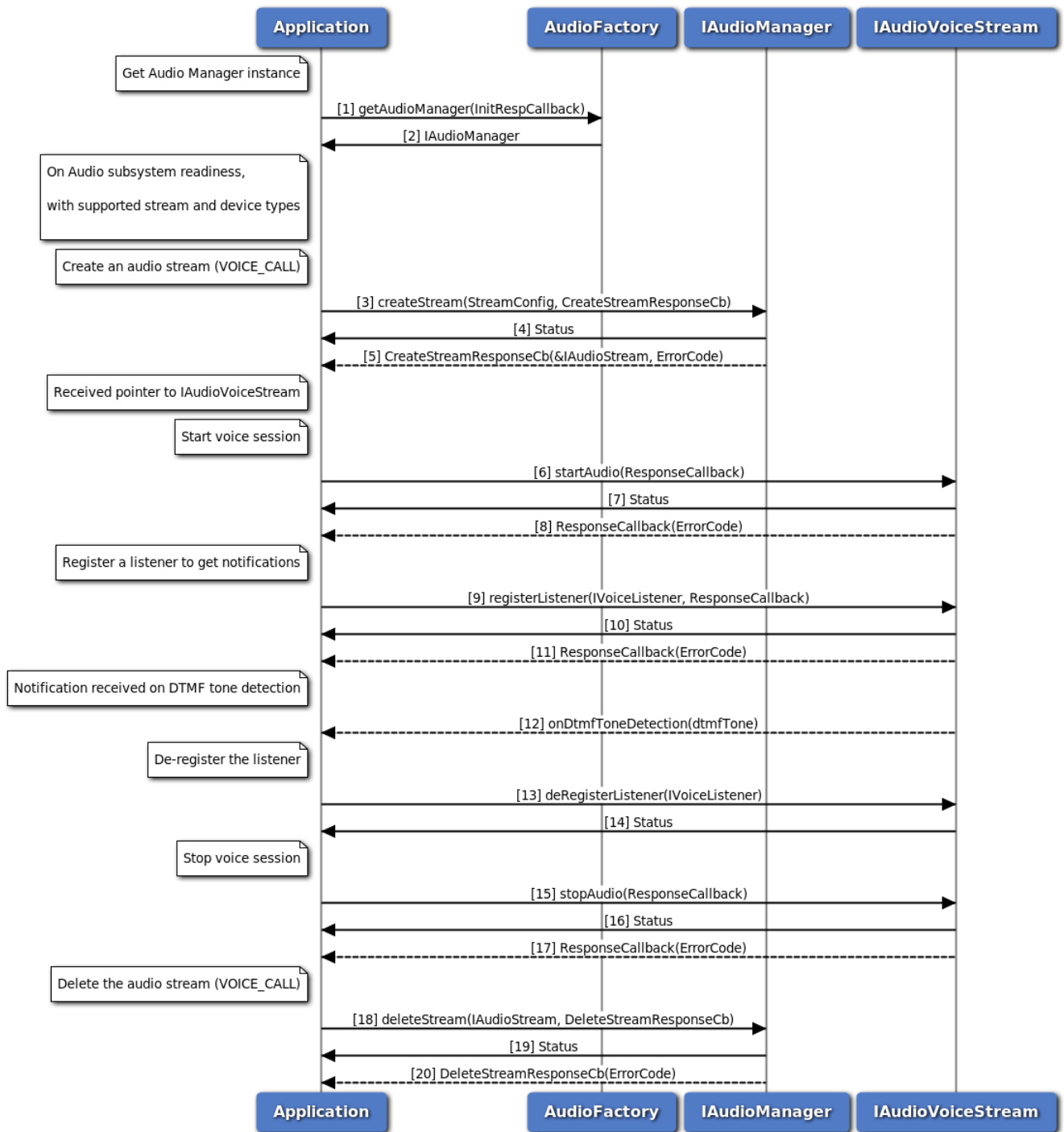

Figure 3-103 Call flow to detect DTMF tone

1. Application requests Audio factory for an Audio Manager.
2. Audio factory return IAudioManager object to application.

3. On Readiness, Application requests to create a voice stream with streamType as VOICE\_CALL.
4. Application receives synchronous status which indicates if the createStream request was sent successfully.
5. Application is notified of the createStream request status (either SUCCESS or FAILED) via the application-supplied callback, with pointer to stream interface referring to IAudioVoiceStream.
6. Application requests to start voice session using startAudio method on IAudioVoiceStream.
7. Application receives synchronous status which indicates if the startAudio request was sent successfully.
8. Application is notified of the startAudio request status (either SUCCESS or FAILED) via the application-supplied callback.
9. Application registers a listener for getting notifications when DTMF tones are detected
10. Application receives synchronous status which indicates if the registerListener request was sent successfully.
11. Application is notified of the registerListener request status (either SUCCESS or FAILED) via the application-supplied callback.
12. Application receives onDtmfToneDetection notification when a DTMF tone is detected in the active voice call session
13. Application deregisters a listener to stop getting notifications
14. Application receives synchronous status which indicates if the deRegisterListener request was sent successfully.
15. Application requests to stop the voice session using stopAudio method on IAudioVoiceStream.
16. Application receives synchronous Status which indicates if the stopAudio request was sent successfully.
17. Application is notified of the stopAudio request status(either SUCCESS or FAILED) via the application-supplied callback.
18. Application requests delete audio stream using deleteStream method.
19. Application receives synchronous Status which indicates if the deleteStream request was sent successfully.
20. Application is notified of the deleteStream request status(either SUCCESS or FAILED) via the application-supplied callback.



### 3.6.7 Audio Playback call flow

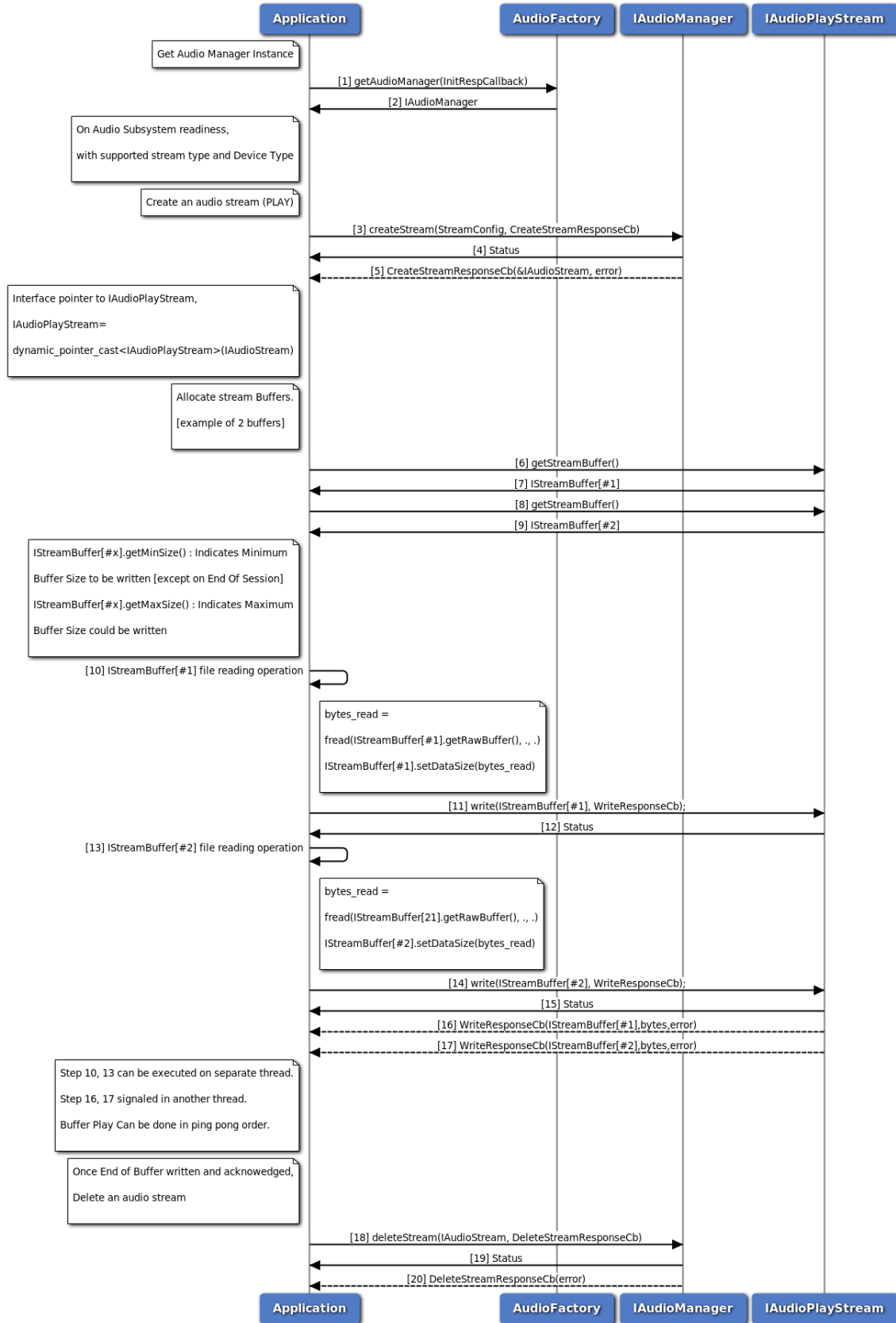

Figure 3-104 Audio Playback call flow

1. Application requests Audio factory for an Audio Manager.
2. Audio factory return IAudioManager object to application.
3. On Readiness, Application requests create audio playback stream using createStream method with streamType as PLAY.
4. Application receives synchronous Status which indicates if the createStream request was sent successfully.
5. Application is notified of the Status of the createStream request (either SUCCESS or FAILED) via the application-supplied callback, with pointer to stream interface referring to IAudioPlayStream.
6. Application requests stream buffer#1 using getStreamBuffer method on IAudioPlayStream.
7. Application receives IStreamBuffer if Success.
8. Application requests stream buffer#2 using getStreamBuffer method on IAudioPlayStream.
9. Application receives IStreamBuffer if Success.
10. Application writes audio samples on buffer#1 using getRawBuffer method on IStreamBuffer.
11. Application writes buffer#1 on Playback session using write method on IAudioPlayStream.
12. Application receives synchronous Status which indicates if the write request was sent successfully.
13. Application writes audio samples on buffer#2 using getRawBuffer method on IStreamBuffer.
14. Application writes buffer#2 on Playback session using write method on IAudioPlayStream.
15. Application receives synchronous Status which indicates if the write request was sent successfully.
16. Application is notified of the buffer#1 write Status (either SUCCESS or FAILED) via the application-supplied write callback with successful bytes written.
17. Application is notified of the buffer#2 write Status (either SUCCESS or FAILED) via the application-supplied write callback with successful bytes written.
18. Application requests delete audio stream using deleteStream method.
19. Application receives synchronous Status which indicates if the deleteStream request was sent successfully.
20. Application is notified of the Status of the deleteStream request (either SUCCESS or FAILED) via the application-supplied callback.

### 3.6.8 Audio Capture call flow

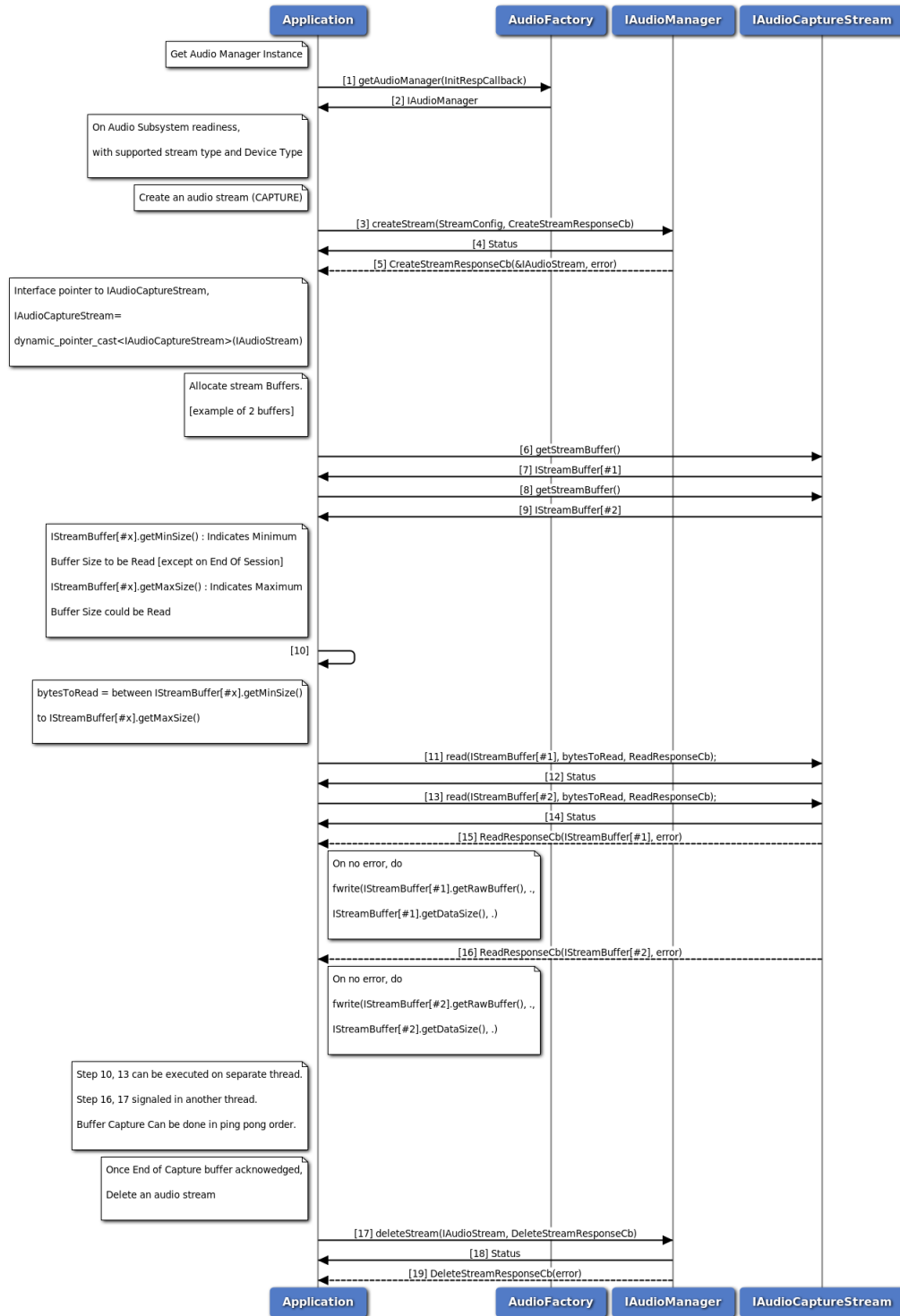
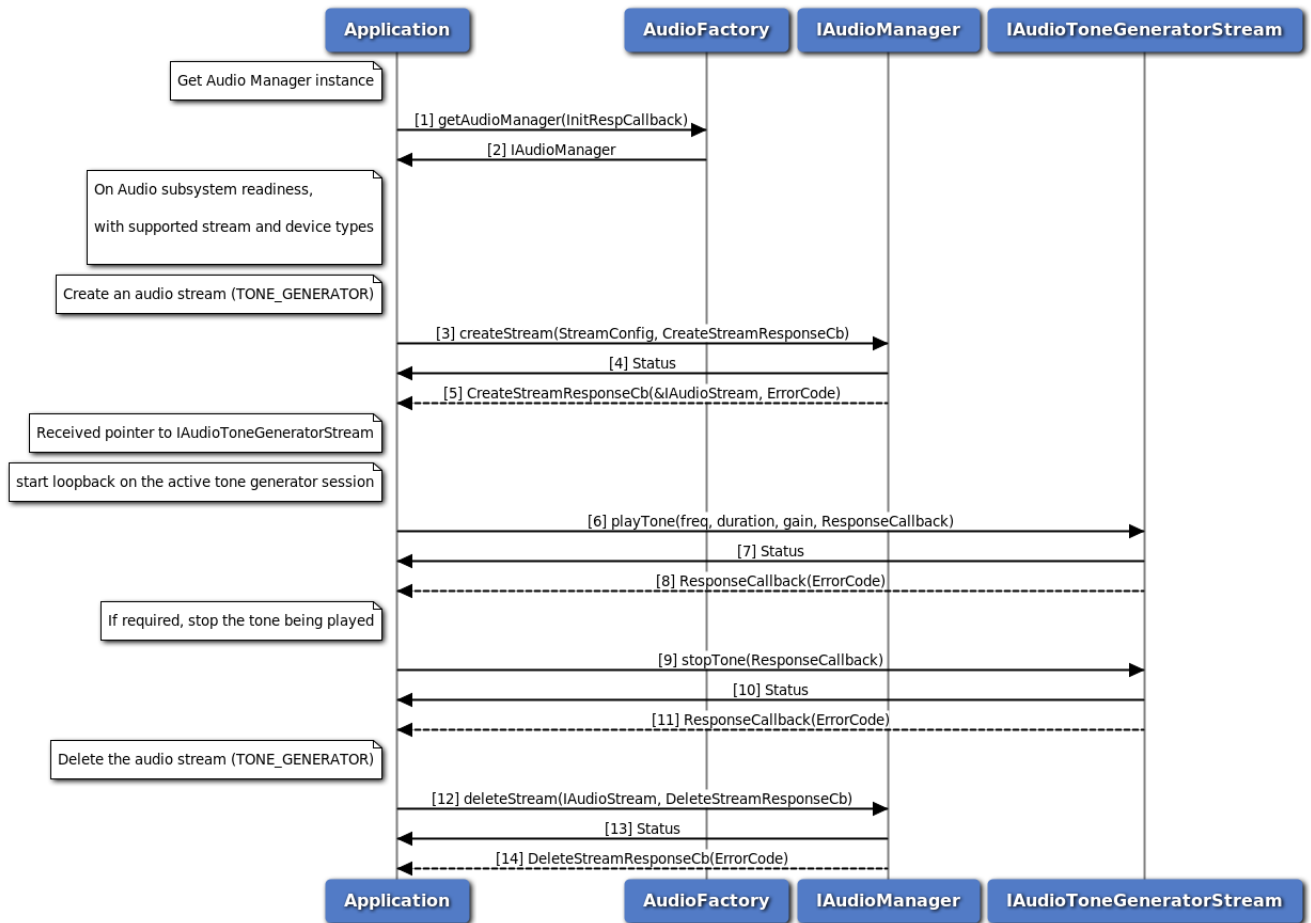

Figure 3-105 Audio Capture call flow

1. Application requests Audio factory for an Audio Manager.
2. Audio factory return IAudioManager object to application.

3. On Readiness, Application requests create audio capture stream using createStream method with streamType as CAPTURE.
4. Application receives synchronous Status which indicates if the createStream request was sent successfully.
5. Application is notified of the Status of the createStream request (either SUCCESS or FAILED) via the application-supplied callback, with pointer to stream interface referring to IAudioCaptureStream.
6. Application requests stream buffer#1 using getStreamBuffer method on IAudioCaptureStream.
7. Application receives IStreamBuffer if Success.
8. Application requests stream buffer#2 using getStreamBuffer method on IAudioCaptureStream.
9. Application receives IStreamBuffer if Success.
10. Application decides read sample size.
11. Application issue read audio samples on buffer#1 using read method on IAudioCaptureStream.
12. Application receives synchronous Status which indicates if the read request was sent successfully.
13. Application issue read audio samples on buffer#2 using read method on IAudioCaptureStream.
14. Application receives synchronous Status which indicates if the read request was sent successfully.
15. Application is notified of the buffer#1 write Status (either SUCCESS or FAILED) via the application-supplied read callback with successful bytes read.
16. Application is notified of the buffer#2 write Status (either SUCCESS or FAILED) via the application-supplied read callback with successful bytes read.
17. Application requests delete audio stream using deleteStream method.
18. Application receives synchronous Status which indicates if the deleteStream request was sent successfully.
19. Application is notified of the Status of the deleteStream request (either SUCCESS or FAILED) via the application-supplied callback.

### 3.6.9 Audio Tone Generator call flow



**Figure 3-106 Call flow to play/stop tone on a sink device**

1. Application requests Audio factory for an Audio Manager.
2. Audio factory return IAudioManager object to application.
3. On Readiness, Application requests to create a tone generator stream with streamType as TONE\_GENERATOR.
4. Application receives synchronous status which indicates if the createStream request was sent successfully.
5. Application is notified of the createStream request status (either SUCCESS or FAILED) via the application-supplied callback, with pointer to stream interface referring to IAudioToneGeneratorStream.
6. Application requests to play tone using playTone method on IAudioToneGeneratorStream.
7. Application receives synchronous status which indicates if the playTone request was sent successfully.
8. Application is notified of the playTone request status (either SUCCESS or FAILED) via the application-supplied callback.

9. Application can optionally stop the tone being played, before its duration expires.
10. Application receives synchronous status which indicates if the stopTone request was sent successfully.
11. Application is notified of the stopTone request status (either SUCCESS or FAILED) via the application-supplied callback.
12. Application requests delete audio stream using deleteStream method.
13. Application receives synchronous Status which indicates if the deleteStream request was sent successfully.
14. Application is notified of the deleteStream request status (either SUCCESS or FAILED) via the application-supplied callback.

### 3.6.10 Audio Loopback call flow

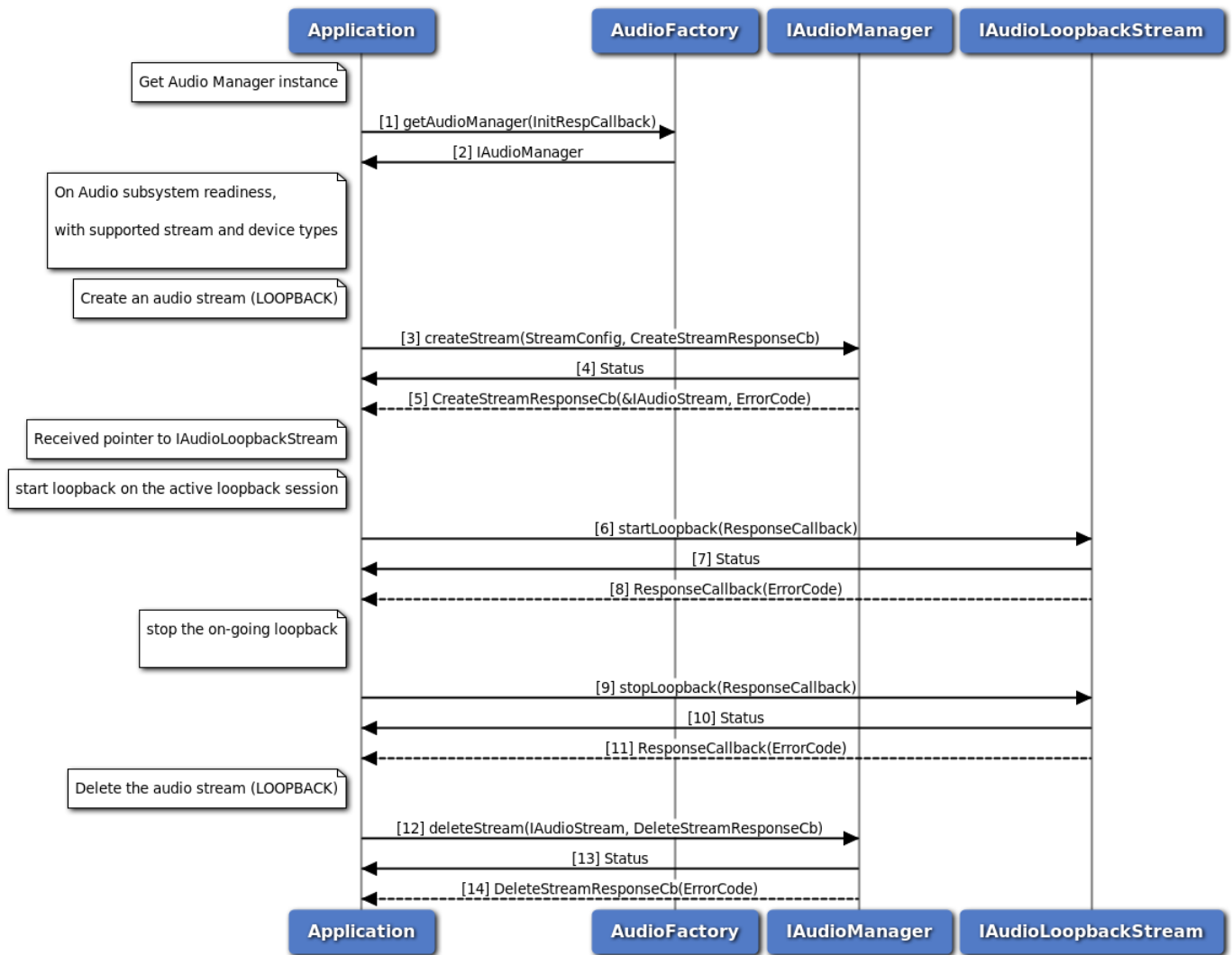

Figure 3-107 Call flow to start/stop loopback between source and sink devices

1. Application requests Audio factory for an Audio Manager.
2. Audio factory return IAudioManager object to application.
3. On Readiness, Application requests to create a loopback stream with streamType as LOOPBACK.
4. Application receives synchronous status which indicates if the createStream request was sent successfully.
5. Application is notified of the createStream request status (either SUCCESS or FAILED) via the application-supplied callback, with pointer to stream interface referring to IAudioLoopbackStream.
6. Application requests to start loopback using startLoopback method on IAudioLoopbackStream.
7. Application receives synchronous status which indicates if the startLoopback request was sent successfully.
8. Application is notified of the startLoopback request status (either SUCCESS or FAILED) via the application-supplied callback.
9. Application requests to stop loopback using stopLoopback method on IAudioLoopbackStream.
10. Application receives synchronous status which indicates if the stopLoopback request was sent successfully.
11. Application is notified of the stopLoopback request status (either SUCCESS or FAILED) via the application-supplied callback.
12. Application requests delete audio stream using deleteStream method.
13. Application receives synchronous Status which indicates if the deleteStream request was sent successfully.
14. Application is notified of the deleteStream request status(either SUCCESS or FAILED) via the application-supplied callback.

### 3.6.11 Compressed audio format playback call flow

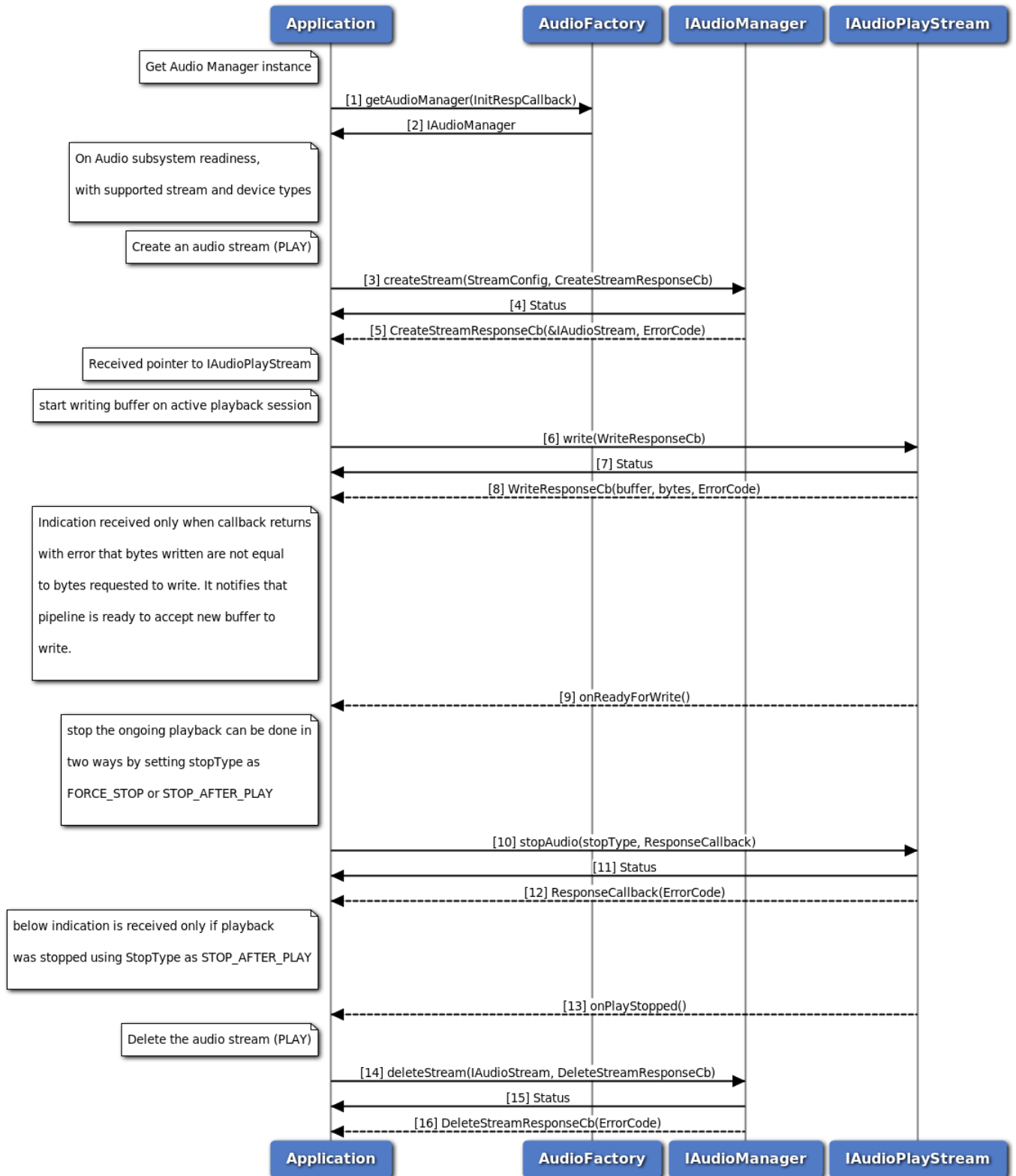

Figure 3-108 Call flow to play Compressed audio format



1. Application requests Audio factory for an Audio Manager.
2. Audio factory return IAudioManager object to application.
3. On Readiness, Application requests to create a play stream with streamType as PLAY.
4. Application receives synchronous status which indicates if the createStream request was sent successfully.
5. Application is notified of the createStream request status (either SUCCESS or FAILED) via the application-supplied callback, with pointer to stream interface referring to IAudioPlayStream.
6. Application requests to write buffer using write method on IAudioPlayStream.
7. Application receives synchronous status which indicates if the write request was sent successfully.
8. Application is notified of the write request status (either SUCCESS or FAILED) via the application-supplied callback along with number of bytes written.
9. Application is notified of when pipeline is ready to accept new buffer if callback returns with error that number of bytes written are not equal to bytes requested.
10. Application send request to stop playback using stopAudio method of IAudioPlayStream.
11. Application receives synchronous status which indicates if the stopAudio request was sent successfully.
12. Application is notified of the stopAudio request status (either SUCCESS or FAILED) via the application-supplied callback.
13. Application is notified via indication that playback is stopped if StopType is STOP\_AFTER\_PLAY.
14. Application requests delete audio stream using deleteStream method.
15. Application receives synchronous Status which indicates if the deleteStream request was sent successfully.
16. Application is notified of the deleteStream request status(either SUCCESS or FAILED) via the application-supplied callback.

### 3.6.12 Audio Transcoding Operation Callflow

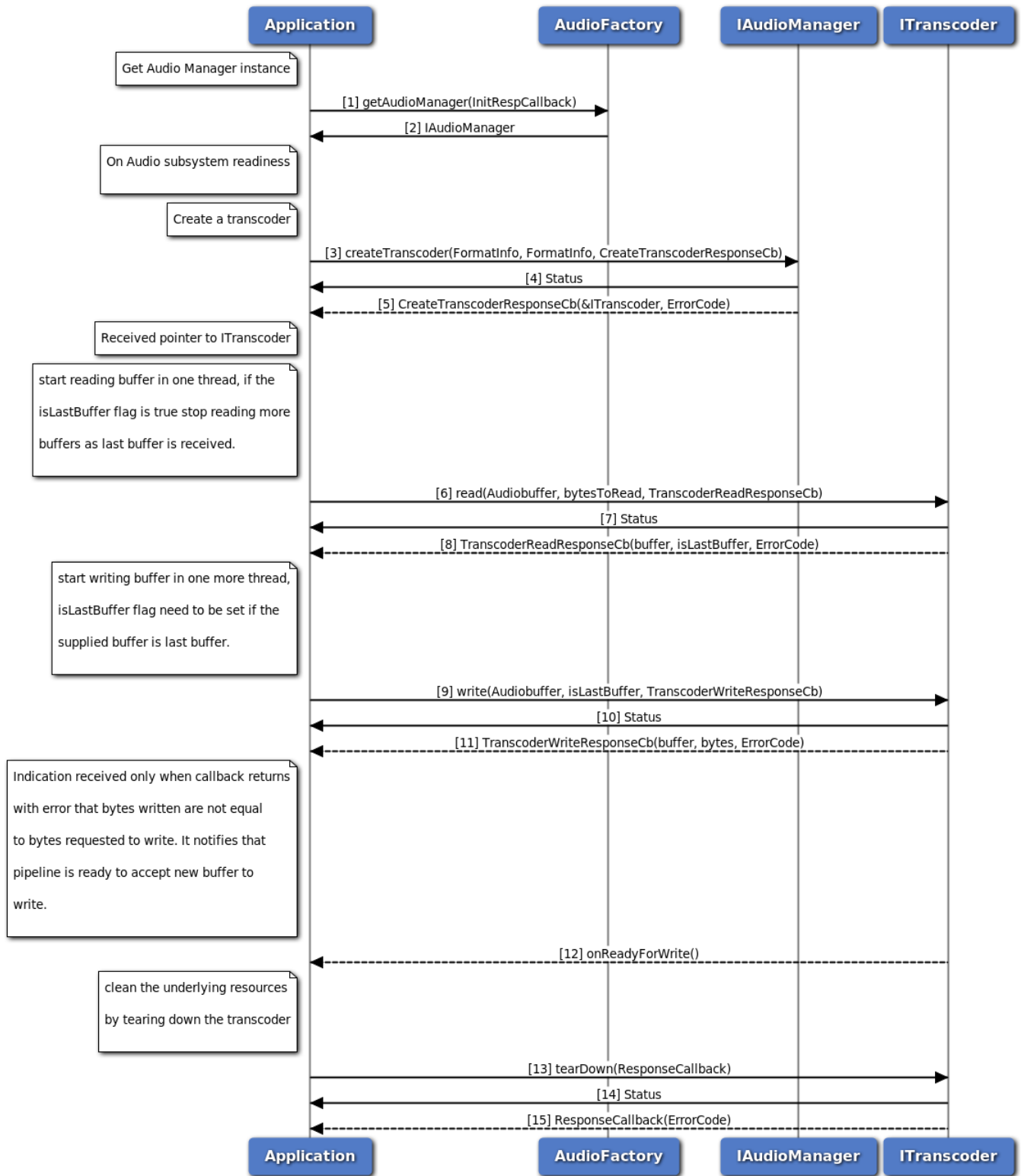

Figure 3-109 Audio Transcoding Operation Callflow

1. Application requests Audio factory for an Audio Manager.
2. Audio factory return IAudioManager object to application.
3. On Readiness, Application requests to create a transcoder.
4. Application receives synchronous status which indicates if the createTranscoder request was sent successfully.
5. Application is notified of the createTranscoder request status (either SUCCESS or FAILED) via the application-supplied callback, with pointer to transcoder interface referring to ITranscoder.
6. Application requests to read buffer using read method on ITranscoder.
7. Application receives synchronous status which indicates if the read request was sent successfully.
8. Application is notified of the read request status (either SUCCESS or FAILED) via the application-supplied callback along with isLastBuffer flag which indicates whether the buffer is last buffer to read or not.
9. Application requests to write buffer using write method on ITranscoder.
10. Application receives synchronous status which indicates if the write request was sent successfully. Application need to mark the isLastBuffer flag, whenever it is providing the last buffer to be write.
11. Application is notified of the write request status (either SUCCESS or FAILED) via the application-supplied callback along with number of bytes written.
12. Application is notified of when pipeline is ready to accept new buffer if callback returns with error that number of bytes written are not equal to bytes requested.
13. Once transcoding done, Application requests to tearDown transcoder as transcoder can not be used for multiple transcoding operations.
14. Application receives synchronous status which indicates if the tearDown request was sent successfully.
15. Application is notified of the tearDown request status (either SUCCESS or FAILED) via the application-supplied callback.

### 3.6.13 Compressed audio format playback on Voice Paths Callflow

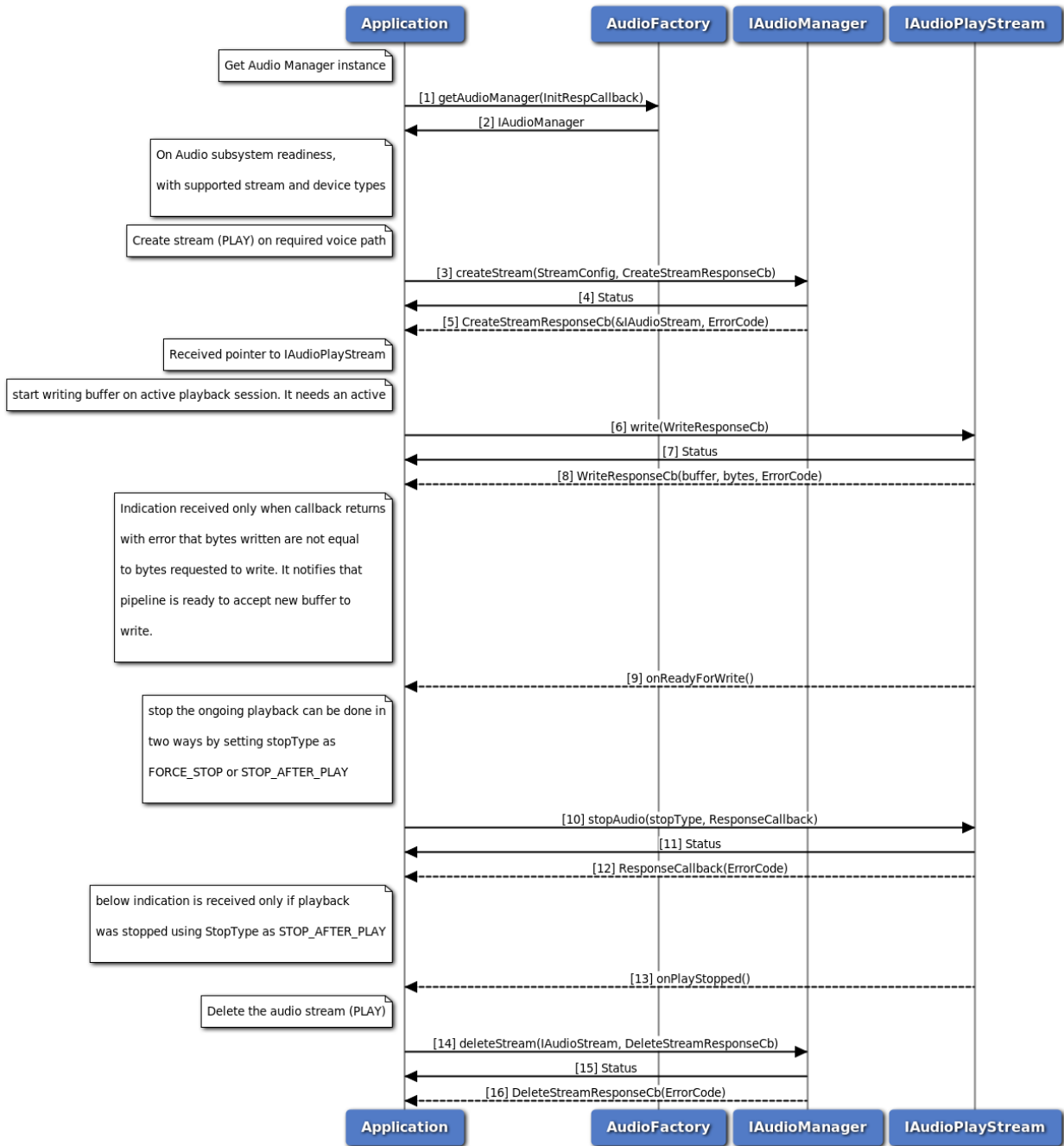
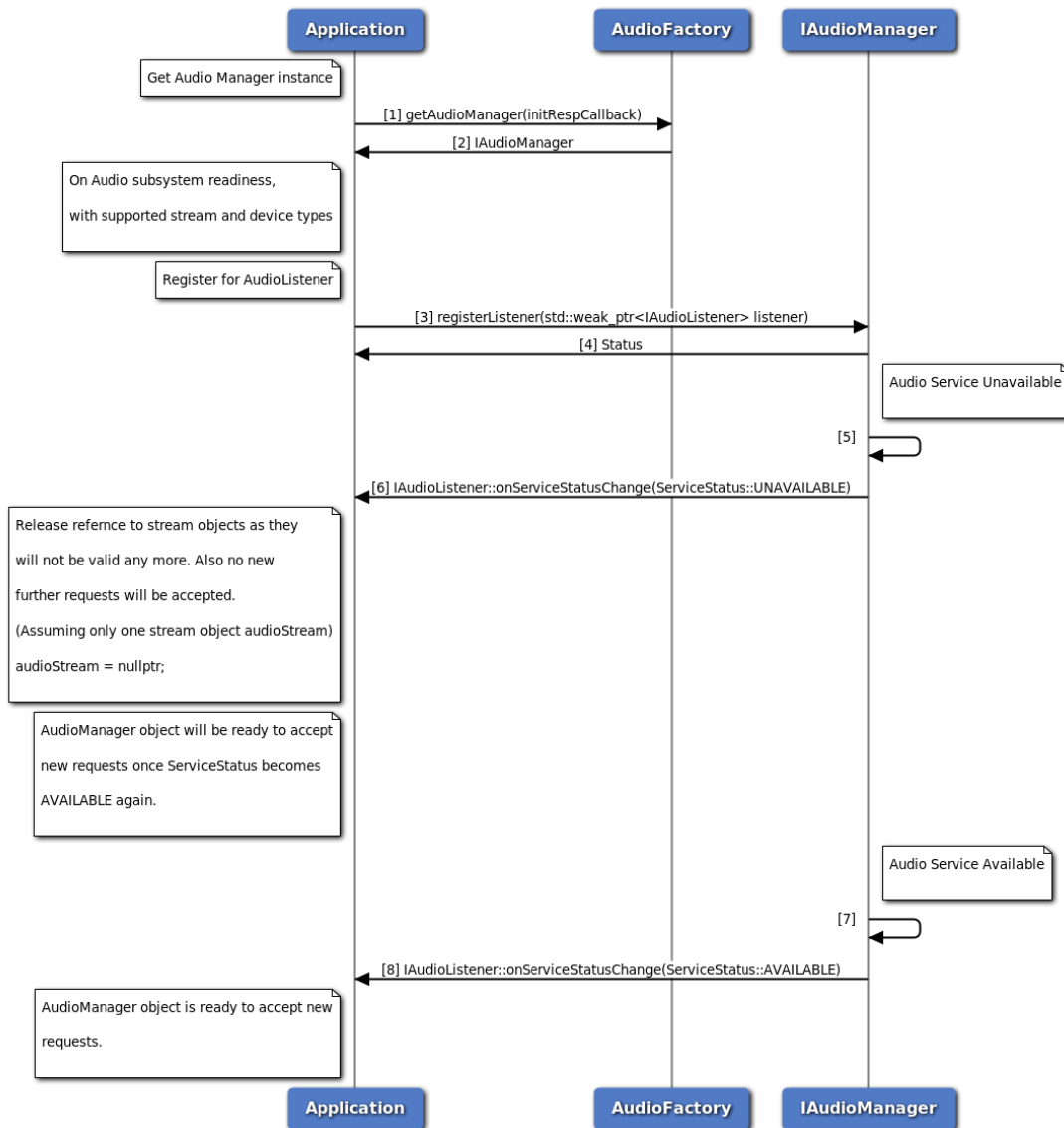

Figure 3-110 Compressed audio format playback on Voice Paths Callflow

1. Application requests Audio factory for an Audio Manager.
2. Audio factory return IAudioManager object to application.
3. On Readiness, Application requests to create a play stream with streamType as PLAY, voicePaths direction as TX or RX and no device is selected.

4. Application receives synchronous status which indicates if the createStream request was sent successfully.
5. Application is notified of the createStream request status (either SUCCESS or FAILED) via the application-supplied callback, with pointer to stream interface referring to IAudioPlayStream.
6. Application requests to write buffer using write method on IAudioPlayStream. It needs an active voice session to play over voice paths, refer IAudioVoiceStream for more details on how to create voice stream.
7. Application receives synchronous status which indicates if the write request was sent successfully.
8. Application is notified of the write request status (either SUCCESS or FAILED) via the application-supplied callback along with number of bytes written.
9. Application is notified of when pipeline is ready to accept new buffer if callback returns with error that number of bytes written are not equal to bytes requested.
10. Application send request to stop playback using stopAudio method of IAudioPlayStream.
11. Application receives synchronous status which indicates if the stopAudio request was sent successfully.
12. Application is notified of the stopAudio request status (either SUCCESS or FAILED) via the application-supplied callback.
13. Application is notified via indication that playback is stopped if StopType is STOP\_AFTER\_PLAY.
14. Application requests delete audio play stream using deleteStream method.
15. Application receives synchronous Status which indicates if the deleteStream request was sent successfully.
16. Application is notified of the deleteStream request status(either SUCCESS or FAILED) via the application-supplied callback.

### 3.6.14 Audio Subsystem Restart Callflow



**Figure 3-111 Audio Subsystem Restart Callflow**

1. Application requests Audio factory for an Audio Manager.
2. Audio factory return IAudioManager object to application.
3. On Readiness, Application requests to register listener to IAudioManager object.
4. Application receives synchronous status which indicates registerListener request was sent successfully.
5. IAudioManager is notified that audio service is unavailable.
6. Application receives a notification from the IAudioManager regarding service status as unavailable. Application is supposed to release references to all the IAudioStream/ITranscoder objects and related resources. Application should not send any new request to IAudioManager or

IAudioStream/ITranscoder objects.

7. IAudioManager is notified that audio service is available.
8. Application receives a notification from the IAudioManager regarding service status as available. IAudioManager object is now ready to accept new requests from application.

### 3.6.15 Audio calibration configuration status

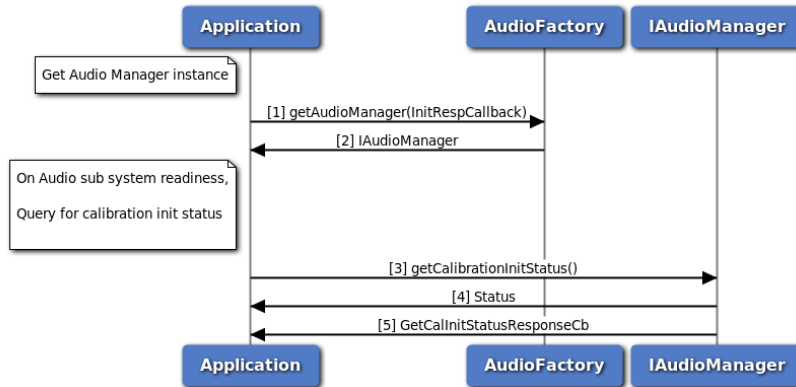

**Figure 3-112 Audio calibration configuration status**

1. Application requests Audio factory for an Audio Manager.
2. Audio factory return IAudioManager object to application.
3. On sub system Readiness, application requests for calibration init status using getCalibrationInitStatus API to IAudioManager.
4. Application receives synchronous status which indicates if the getCalibrationInitStatus request was sent successfully.
5. Application is notified with CalibrationInitStatus and suitable error code via the application supplied callback.

## 3.7 Thermal

### 3.7.1 Thermal Manager API call flow

Thermal manager provides APIs to get list of thermal zones and cooling devices. It also contains APIs to get a particular thermal zone and a particular cooling device details with the given Id.

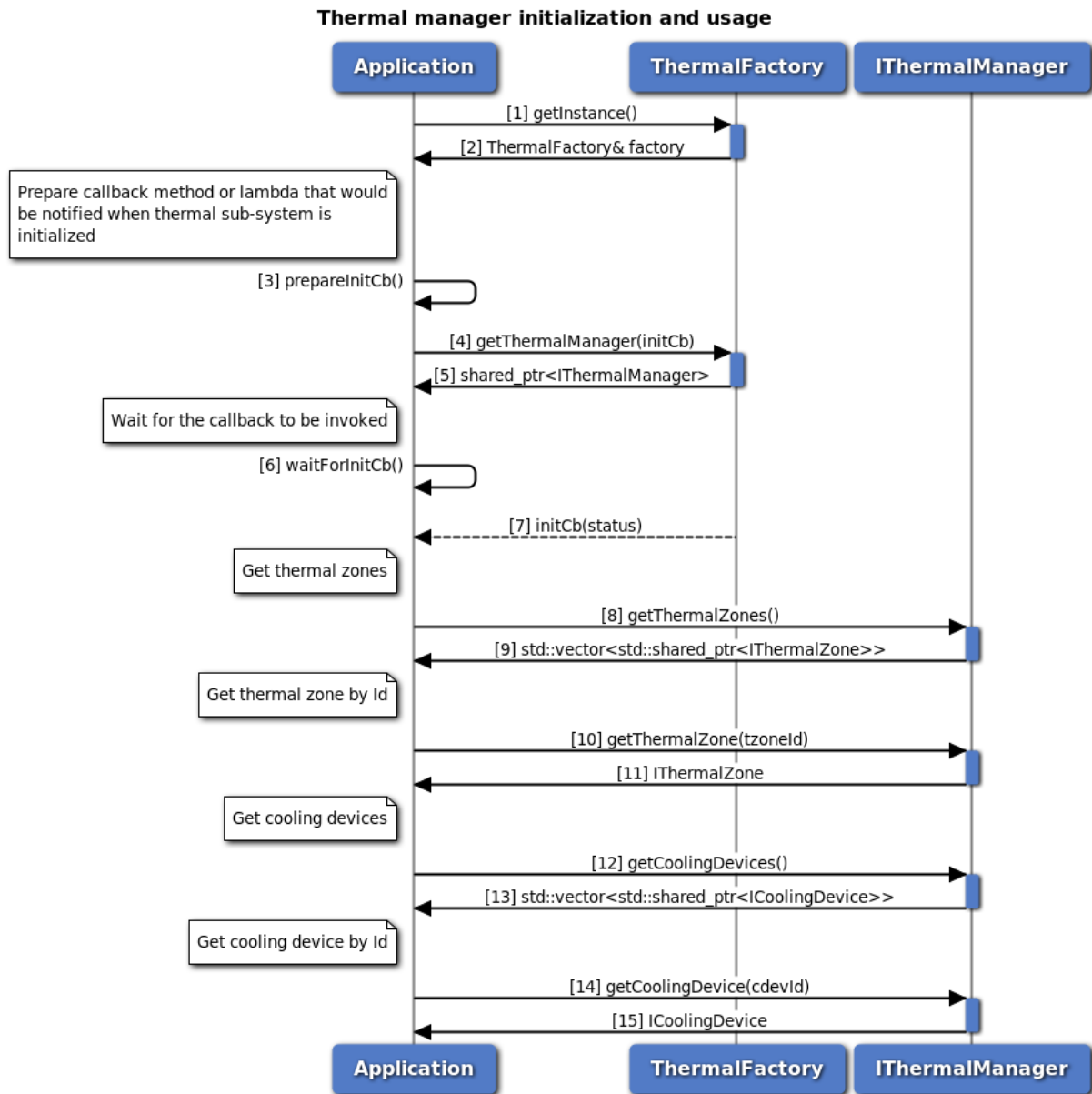

Figure 3-113 Thermal manager API call flow

1. Application requests for an instance of thermal factory.
2. Thermal factory instance is received by the application.
3. Application prepares the callback which would be called on initialization of thermal manager.
4. Application request for thermal manager from thermal factory.
5. Thermal factory returns an instance of the thermal manager object.
6. Application waits for initialization callback to be called.



7. Thermal factory invokes the callback once initialization completes.
8. Application sends request to get all thermal zones using IThermalManager object.
9. Thermal manager returns the list of thermal zones to the application.
10. Application requests for a particular thermal zone details by mentioning the thermal zone Id.
11. Application receives thermal zone details with the given Id from thermal manager.
12. Application sends request to get all cooling devices using IThermalManager object.
13. Thermal manager returns the list of cooling devices to the application.
14. Application requests for a particular cooling device details by passing the cooling device Id.
15. Thermal Manager sends cooling device details with the given Id to the application.

### 3.7.2 Call flow to register/remove listener for Thermal manager notifications.

Thermal listeners provide a set of listeners on which the app is notified when certain events occur. It also allows an application to register some or all types of notifications.

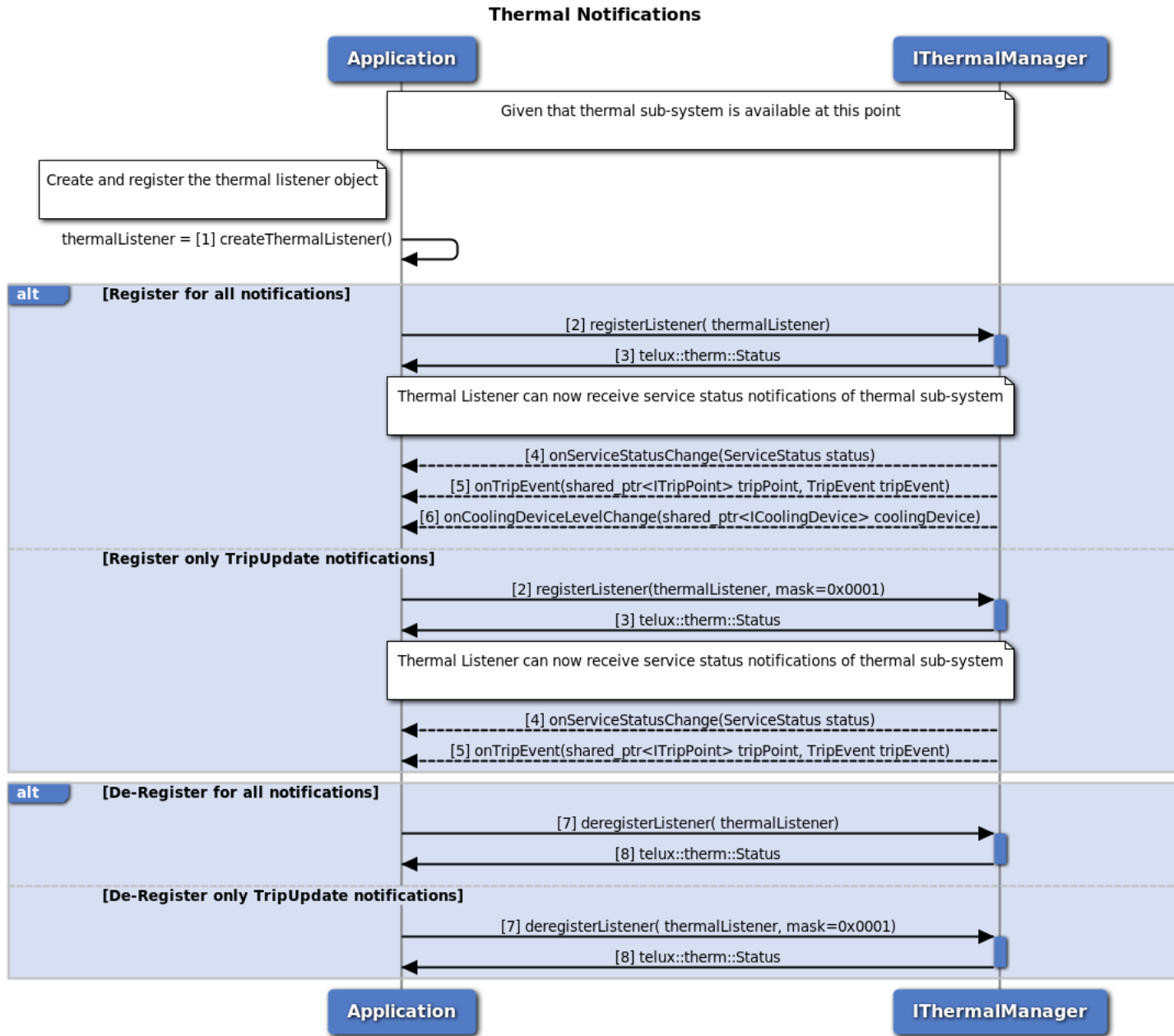

**Figure 3-114 Call flow to register/remove listener for Thermal manager notifications**

The thermal sub-system should have been initialized successfully with SERVICE\_AVAILABLE as a pre-requisite for any thermal notifications and a valid ThermalManager object is available.

1. Application should create a thermal listening object.

2. Application can register a listener for specific or all type of notifications by providing a different mask value. The default value of mask is 0xFFFF which indicates for all type of notifications. The SSR notification is registered by default, whether it provides mask values or not.
3. Status of register listener i.e. either SUCCESS or FAILED will be returned to the application.
4. Application is notified when service status changes.
5. Application registered for this notification will be notified when a trip event occurs for any thermal zone.
6. Application registered for this notification will be notified when a cooling device changes its states.
7. Application can de-register a listener for specific or all type of notifications by providing a different mask value. The default value of mask is 0xFFFF which indicates for all type of notifications including SSR. The SSR notification will not be deregistered if the request provided a mask value.
8. Status of de-register listener i.e. either SUCCESS or FAILED will be returned to the application.

### 3.7.3 Thermal shutdown management

Thermal shutdown manager provides APIs to set/get auto thermal shutdown modes. It also has listener interface for notifications. Application will get the Thermal-shutdown manager object from thermal factory. The application can register a listener for updates in thermal auto shutdown modes and its management service status. Also there is provision to set the desired thermal auto-shutdown mode.

When application is notified of service being unavailable, the thermal auto-shutdown mode updates are inactive. After service becomes available, the existing listener registrations will be maintained.

As a reference, auto-shutdown management in an eCall application is described in the below sections.

### 3.7.3.1 Call flow to register/remove listener for Thermal auto-shutdown mode updates.

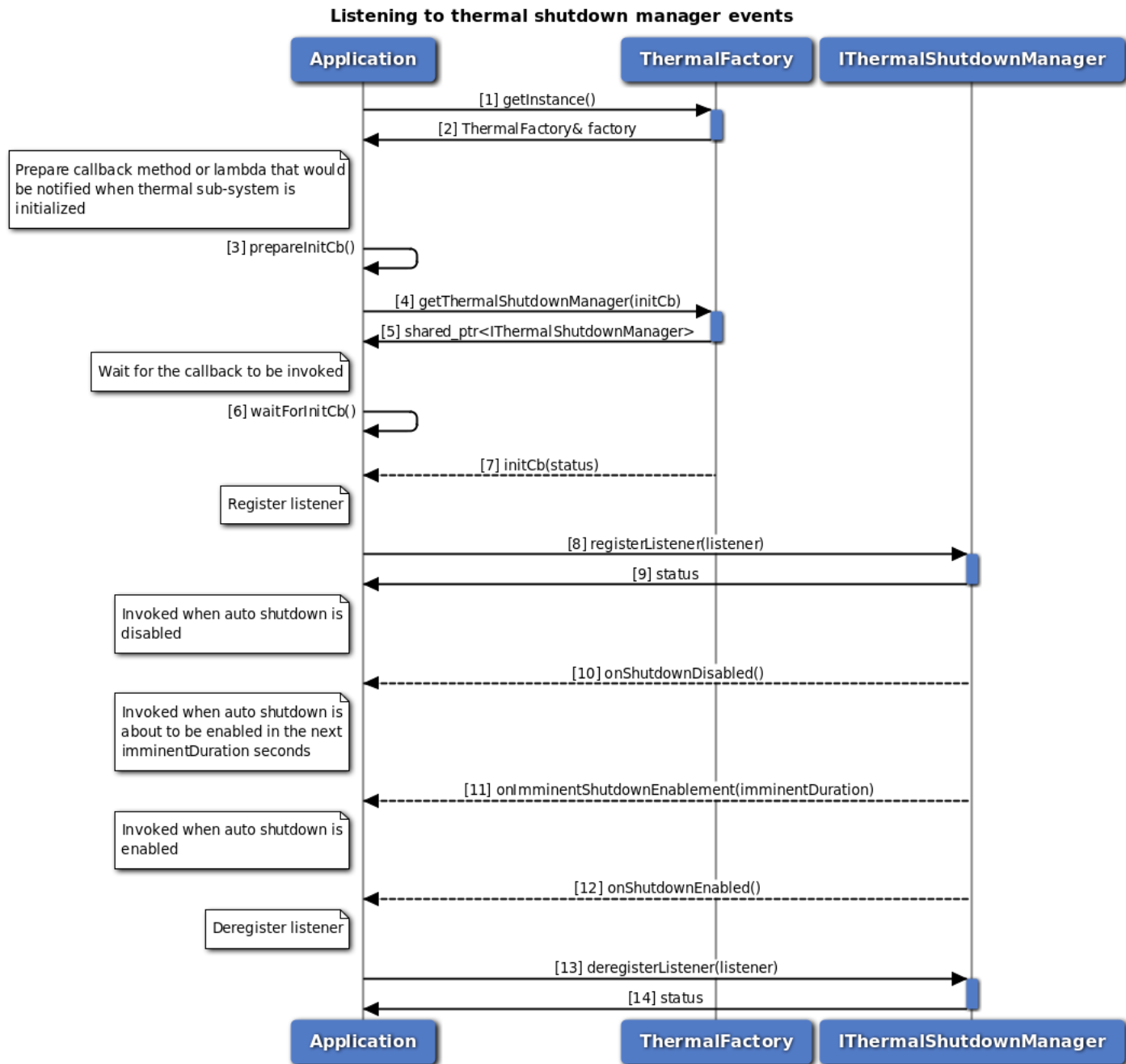

**Figure 3-115 Call flow to register/remove listener for Thermal shutdown manager**

1. Application requests for an instance of thermal factory.
2. Thermal factory instance is received by the application.
3. Application prepares the callback which would be called on initialization of thermal shutdown manager.
4. Application request for thermal shutdown manager from thermal factory.

5. Thermal factory returns an instance of the thermal shutdown manager object.
6. Application waits for initialization callback to be called.
7. Thermal factory invokes the callback once initialization completes.
8. Application can register a listener for getting notifications on Thermal auto-shutdown mode updates.
9. Status of register listener i.e. either SUCCESS or FAILED will be returned to the application.
10. Application receives a notification that thermal auto-shutdown mode is disabled.
11. Application receives a notification that thermal auto-shutdown mode is going to be enabled soon. The exact duration is also received as part of notification.
12. Application receives a notification that thermal auto-shutdown mode is enabled.
13. Application can remove listener.
14. Status of remove listener i.e. either SUCCESS or FAILED will be returned to the application.

### 3.7.3.2 Call flow to set/get the Thermal auto-shutdown mode

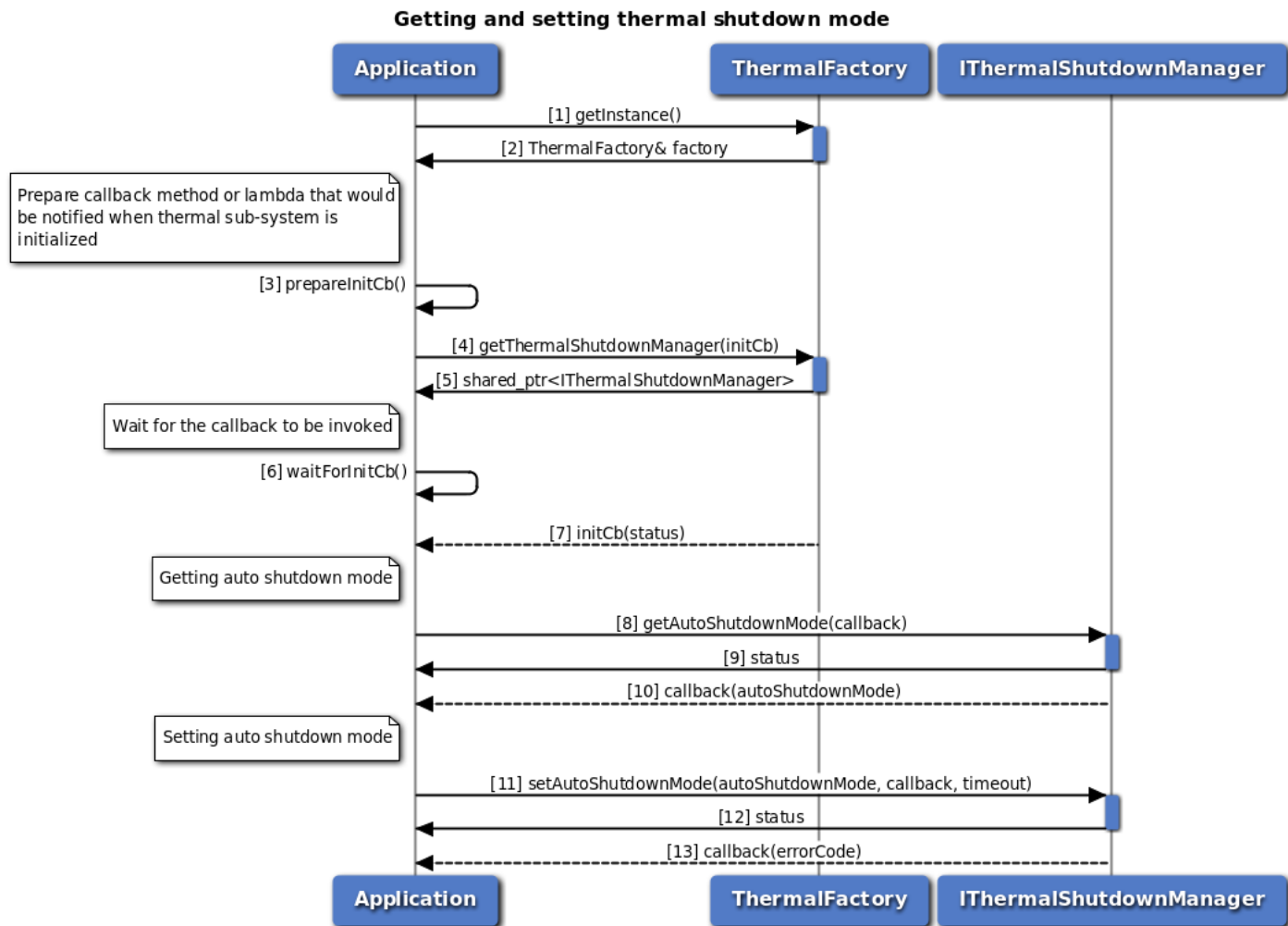

Figure 3-116 Call flow to set/get the Thermal auto-shutdown mode

1. Application requests for an instance of thermal factory.
2. Thermal factory instance is received by the application.
3. Application prepares the callback which would be called on initialization of thermal shutdown manager.
4. Application request for thermal shutdown manager from thermal factory.
5. Thermal factory returns an instance of the thermal shutdown manager object.
6. Application waits for initalization callback to be called.
7. Thermal factory invokes the callback once initialization completes.
8. Application can query the thermal auto-shutdown mode.
9. Application receives synchronous status which indicates if the request was sent successfully.
10. Application receives the auto-shutdown mode asynchronously.
11. Application can set the thermal auto-shutdown mode to ENABLE or DISABLE.
12. Application receives synchronous status which indicates if the request was sent successfully.
13. Optionally, the response to setAutoShutdownMode request can be received by the application.

### 3.7.3.3 Call flow to manage thermal auto-shutdown from an eCall application.

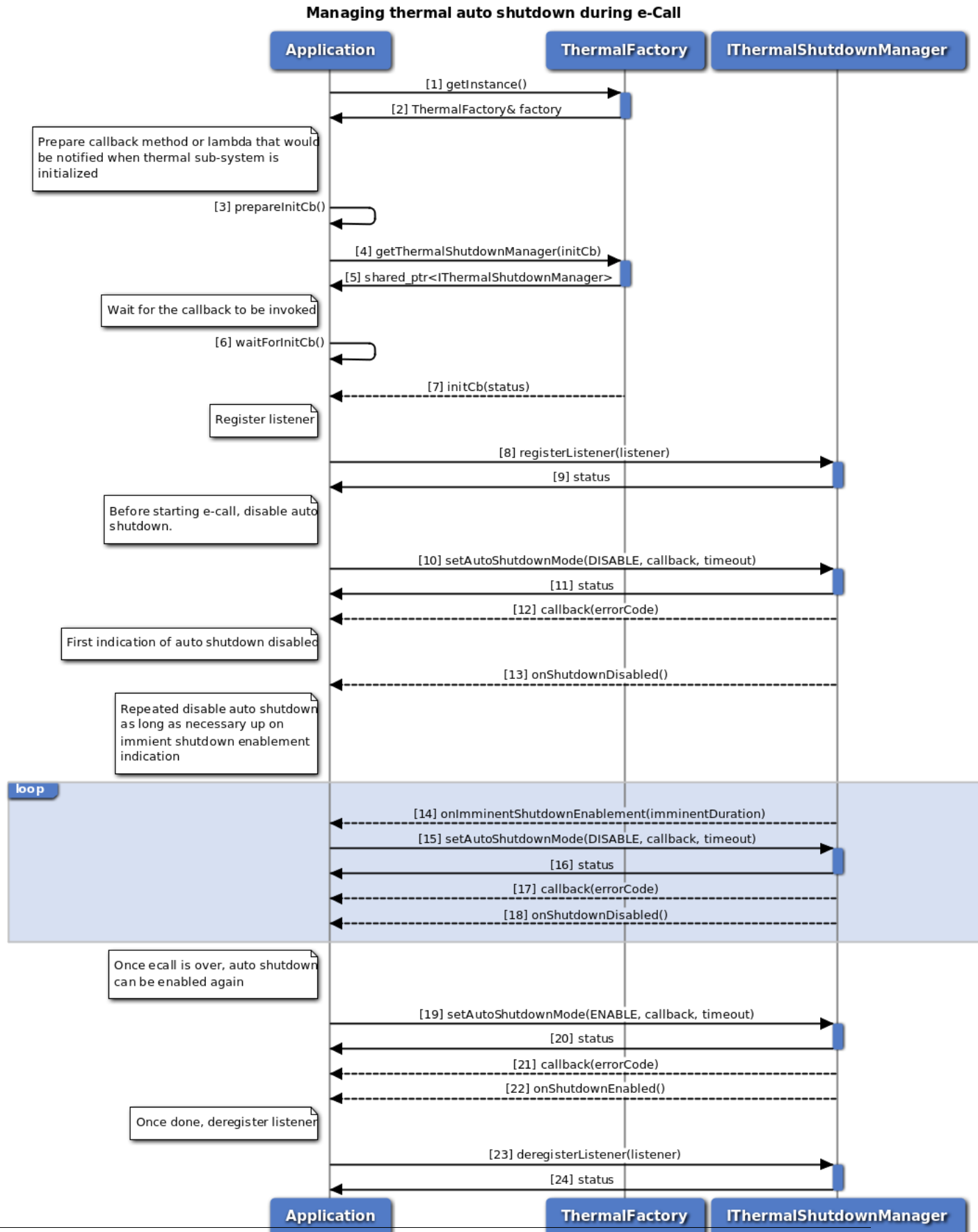

Figure 3-117 Call flow to manage thermal auto-shutdown from an eCall application

1. Application requests for an instance of thermal factory.
2. Thermal factory instance is received by the application.
3. Application prepares the callback which would be called on initialization of thermal shutdown manager.
4. Application request for thermal shutdown manager from thermal factory.
5. Thermal factory returns an instance of the thermal shutdown manager object.
6. Application waits for initialization callback to be called.
7. Thermal factory invokes the callback once initialization completes.
8. Application can register a listener for getting notifications on Thermal auto-shutdown mode updates.
9. Status of register listener i.e. either SUCCESS or FAILED will be returned to the application.
10. Application disables auto-shutdown using setAutoShutdownMode API, to prevent a possible thermal auto-shutdown during eCall.
11. Application receives synchronous status which indicates if the request was sent successfully.
12. Optionally, the response to setAutoShutdownMode request can be received by the application.
13. Application receives a notification that thermal auto-shutdown mode is disabled.
14. Application receives an imminent auto-shutdown enable notification and system will attempt to enable auto-shutdown after a certain period. This notification is received if application does not enable auto-shutdown due to an active eCall.
15. If the eCall is still active, the application disables auto-shutdown before it gets enabled automatically.
16. Application receives synchronous status which indicates if the request was sent successfully.
17. Optionally, the response to setAutoShutdownMode request can be received by the application.
18. Application receives a notification that thermal auto-shutdown mode is disabled. Steps 14 to 18 are repeated as long as the eCall is active.
19. When the eCall is completed, the application immediately enables auto-shutdown using setAutoShutdownMode API.
20. Application receives synchronous status which indicates if the request was sent successfully.
21. Optionally, the response to setAutoShutdownMode request can be received by the application.
22. Application receives a notification that thermal auto-shutdown mode is enabled.
23. Application can remove listener.
24. Status of remove listener i.e. either SUCCESS or FAILED will be returned to the application.

### 3.8 TCU Activity Management

An application can get the appropriate TCU-activity manager (i.e. slave or master) object from the power factory. The TCU-activity manager configured as the master is responsible for triggering state transitions. TCU-activity manager configured as a slave is responsible for listening to state change indications and acknowledging when it performs necessary tasks and prepares for the state transition. A machine in this power management framework represents an application processor subsystem or a host/guest virtual machine on hypervisor based platforms.



- Only one master is allowed in the system, and currently we only support allowing the master on the primary/host machine and not on the guest virtual machine.
- It is expected that all processes interested in a TCU-activity state change should register as slaves.
- When the master changes the TCU-activate state, slaves connected to the impacted machine are notified.
- Master can trigger the TCU-activity state change of a specific machine or all machines at once.
- If the slave wants to differentiate between a state change indication that is the result of a trigger for all machines or a trigger for its specific machines, it can be detected using the machine name provided in the listener API.
- When the master triggers an all machines TCU-activity state change, only the machines that are not in the desired state will undergo the state transition, and the slaves to those machines will be notified.
- In the case of
  - suspend or shutdown trigger:
    - After becoming ready for state change, all slave clients should acknowledge back.
    - The master client will get notification about the consolidated acknowledgement status of all slave clients.
    - On getting a successful consolidated acknowledgement from all the slaves for the suspend trigger, the power framework allows the respective machine to suspend. On getting a successful consolidated acknowledgement from all the slaves for the shutdown trigger, the power framework triggers the respective machine shutdown without waiting further.
    - If the slave client sends a NACK to indicate that it is not ready for state transition or fails to acknowledge before the configured time, then the master will get to know via a consolidated acknowledgement / slave acknowledgement status notification.
    - In such failed cases, if the master wants to stop the state transition considering the information in the consolidated acknowledgement, then the master is allowed to trigger a new TCU-activity state change, or else the state transition will proceed after the configured timeout.
  - resume trigger:
    - Power framework will prevent the respective machine from going into suspend.
    - No acknowledgement will be required from slave clients and the master will not be getting consolidated acknowledgement / slave acknowledgement as machine will be already resumed.

When the application is notified about the service being unavailable, the TCU-activity state notifications will be inactive. After the service becomes available, the existing listener registrations will be maintained.

### 3.8.1 Call flow to register/remove listener for TCU-activity manager

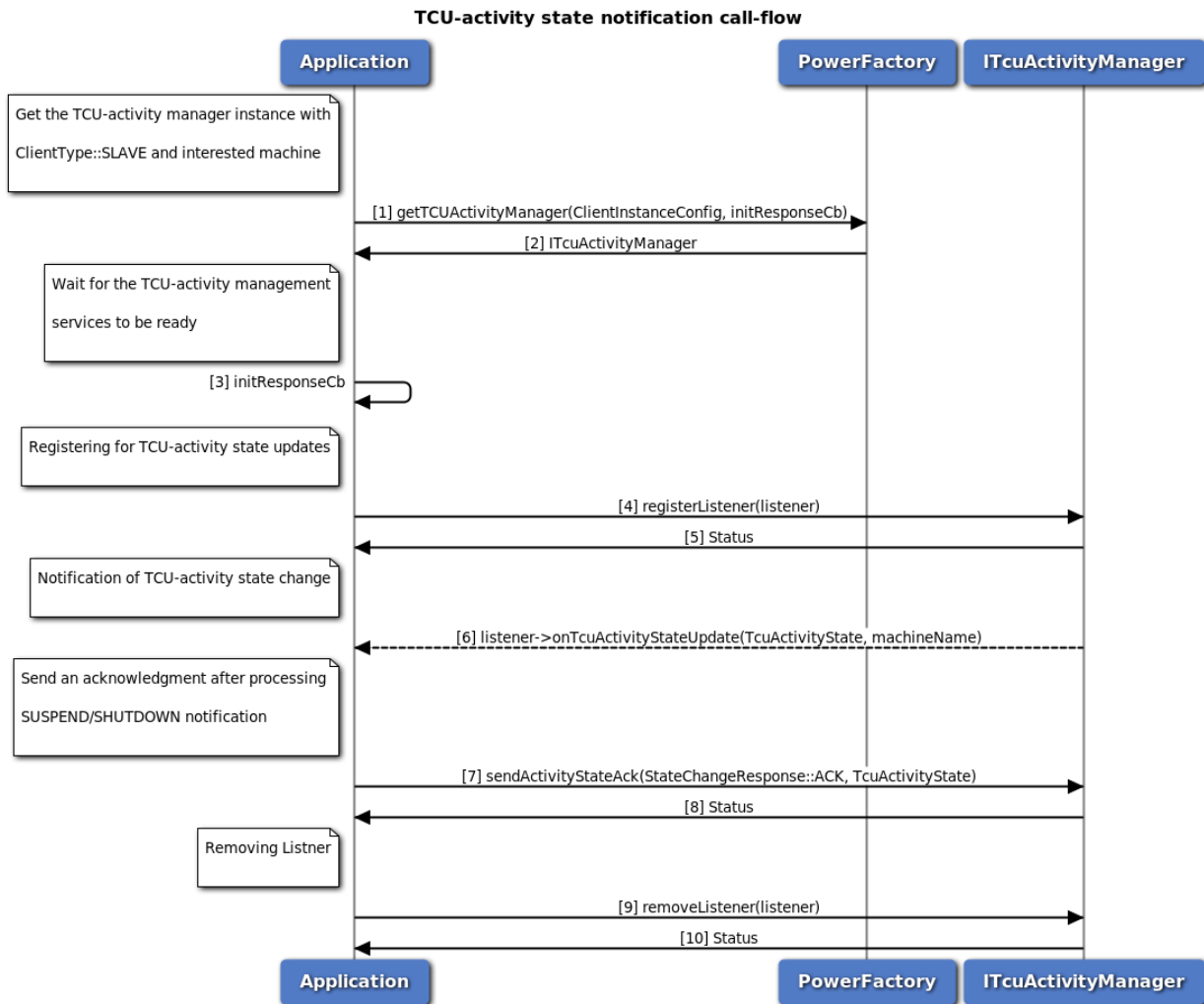
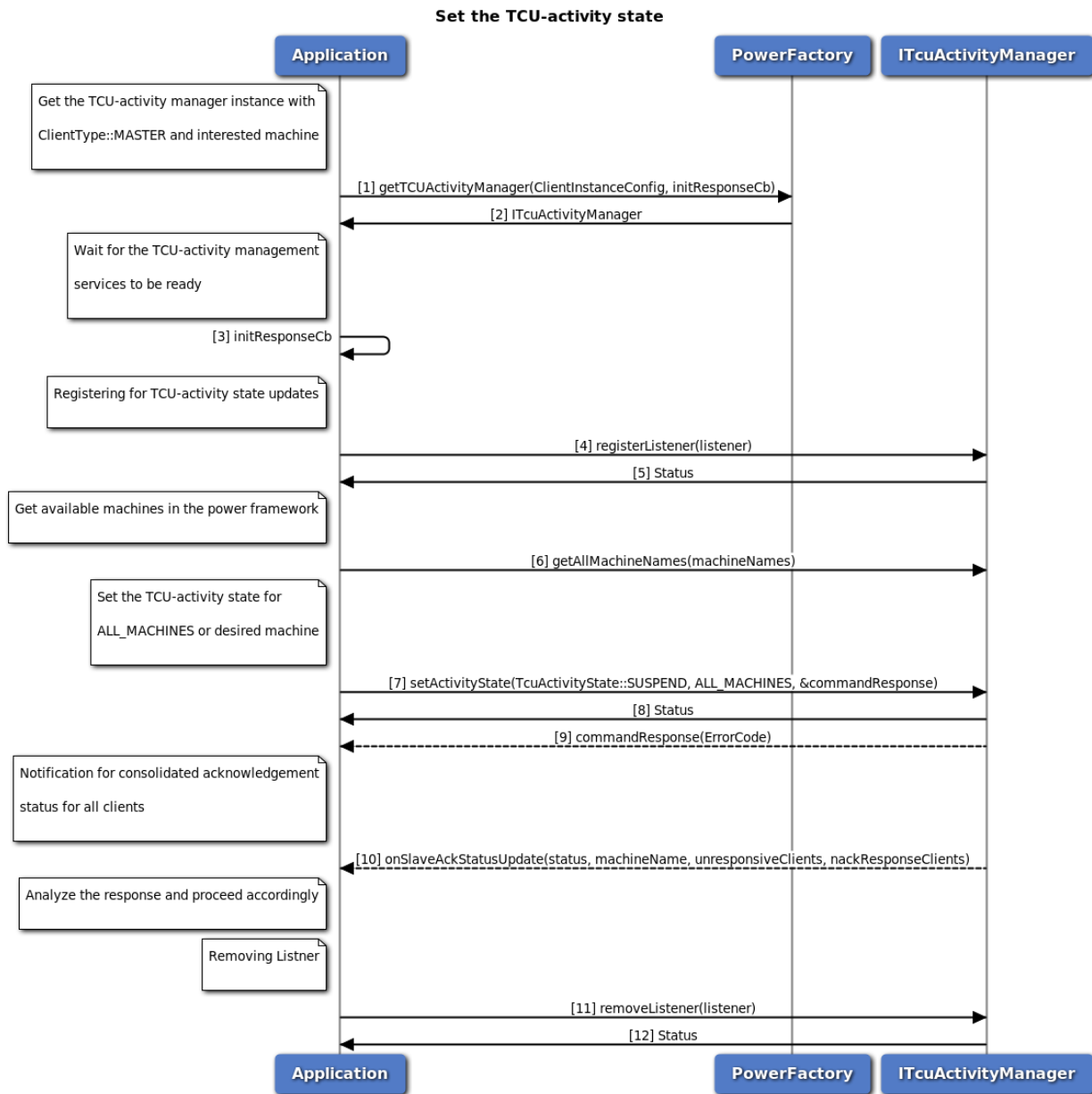

**Figure 3-118 Call flow to register/remove listener for TCU-activity manager**

1. Application requests power factory for TCU-activity manager object, with clientType as slave. slave clients set up to listen to their LOCAL\_MACHINE. Also, it is recommended to give a unique name to each slave client so that client can be identified later in case of failure.
2. Power factory returns ITcuActivityManager object using which application will register or remove a listener.
3. Wait for the TCU-activity management services to be ready.
4. Application can register a listener for getting notifications on TCU-activity state updates on the machine. Some of the listener APIs are designed for slave clients and others for master clients. Listener APIs intended for the master client will not be sent to the slave client, and listner APIs intended for the slave client will not be sent for the master client.
5. Status of register listener i.e. either SUCCESS or FAILED will be returned to the application.
6. Application will get TCU-activity state notifications like suspend, resume and shutdown.

7. Application will send one acknowledgement, after processing(save any required information) suspend/shutdown notifications. This indicates the readiness of application for state-transition. However the TCU-activity management service doesn't wait for acknowledgement indefinitely, before performing the state transition. In the acknowledgement, slave can specify the machine name received in the notification in the previous step.
8. Application receives synchronous status which indicates if the acknowledgement was sent successfully.
9. Application can remove listener.
10. Status of remove listener i.e. either SUCCESS or FAILED will be returned to the application.

### 3.8.2 Call flow to set the TCU-activity state



**Figure 3-119 Call flow to set the TCU-activity state**

1. Application requests power factory for TCU-activity manager object, with clientType as master.
2. Power factory returns ITcuActivityManager object using which application will set the TCU-activity state.
3. Wait for the TCU-activity management services to be ready.
4. Application can register a listener for getting notifications on TCU-activity state.
5. Status of register listener i.e. either SUCCESS or FAILED will be returned to the application

6. Get a list of available machine names in the power framework if the user is interested in the state transition of a specific machine.
7. Application can set the TCU-activity state to suspend, resume or shutdown.
8. Application receives synchronous status which indicates if the request was sent successfully.
9. Optionally, the response to setActivityState request can be received by the application.
10. The application waits for consolidated acknowledgement status and analyzes the response. If status is not SUCCESS and the master expects to stop state transition considering the provided information, then call setActivityState and revert state, or else state transition will proceed after the configured timeout in /etc/power\_state.conf.
11. Application can remove listener.
12. Status of remove listener i.e. either SUCCESS or FAILED will be returned to the application.

### 3.9 Modem Config

Modem Config manager provides APIs to request all configs from modem, load/delete modem config files from modem's storage, activate/deactivate a modem config file, get the active config details, set and get auto config selection mode. It also has listener interface for notifications for config activation update status. Application will get the Modem Config manager object from config factory. The application can register a listener for updates regarding modem config activation.

### 3.9.1 Call flow to load and activate a modem config file.

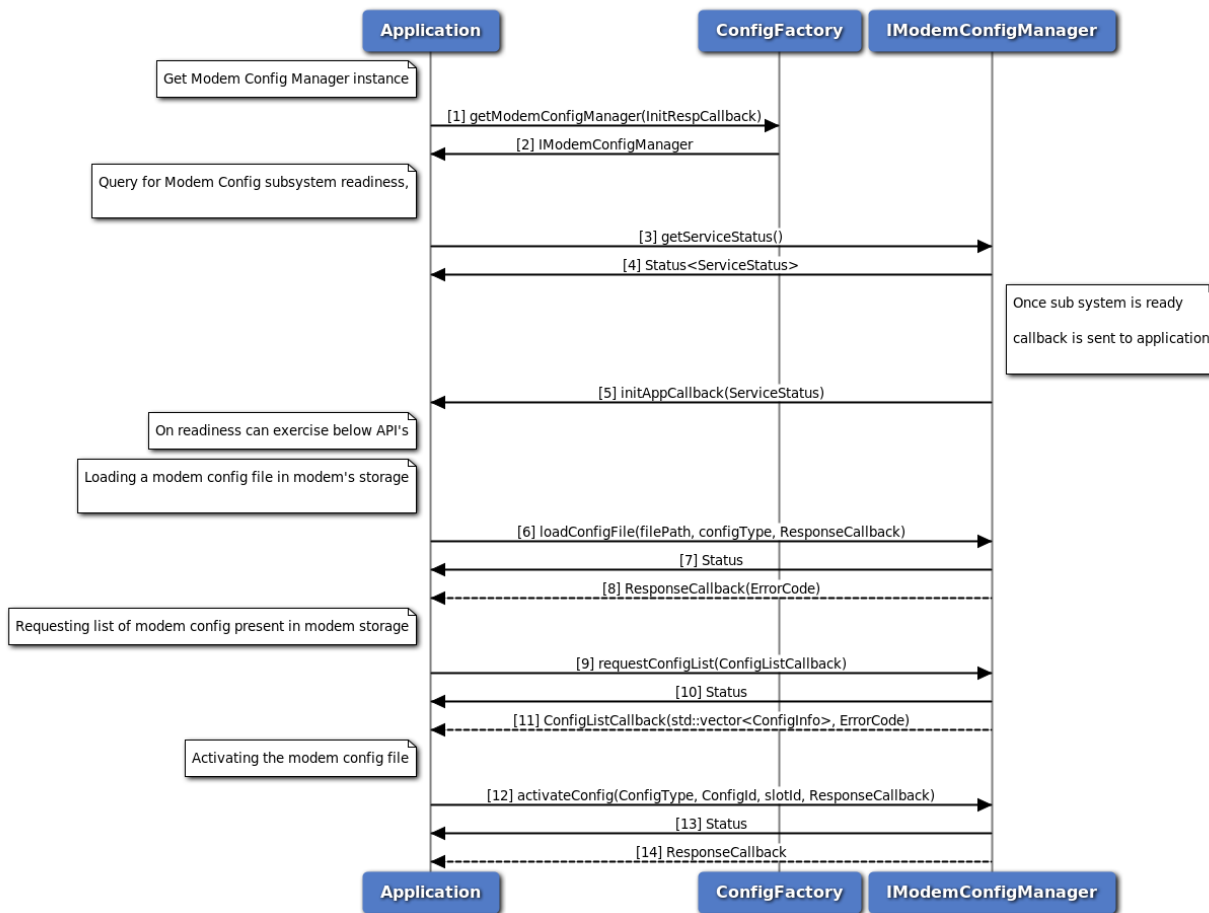

Figure 3-120 Modem Config load and activate call flow

1. Application requests Config factory for ModemConfig Manager and passes callback pointer.
2. Config factory return IModemConfigManager object to application.
3. Application can use IModemConfigManager::getServiceStatus to determine the state of sub system.
4. The application receives the ServiceStatus of sub system which indicates the state of service.
5. IModemConfigManager notifies the application when the subsystem is ready through the callback mechanism.
6. Application sends a request to load config file in modem's storage.
7. Application receives synchronous Status which indicates if the request to load config file was sent successfully.
8. Application is notified of the Status of the loadConfigFile request (either SUCCESS or FAILED) via the application-supplied callback.
9. Application sends a request to get list of all modem configs from modem's storage.
10. Application receives synchronous Status which indicates if the request to get config list was sent

successfully.

11. Application is notified of the Status of the requestConfigList request (either SUCCESS or FAILED) via the application-supplied callback along with list of modem configs.
12. Application sends a request to activate config file.
13. Application receives synchronous Status which indicates if the request to activate config file was sent successfully.
14. Application is notified of the Status of the activateConfig request (either SUCCESS or FAILED) via the application-supplied callback.

### 3.9.2 Call flow to deactivate and delete a modem config file.

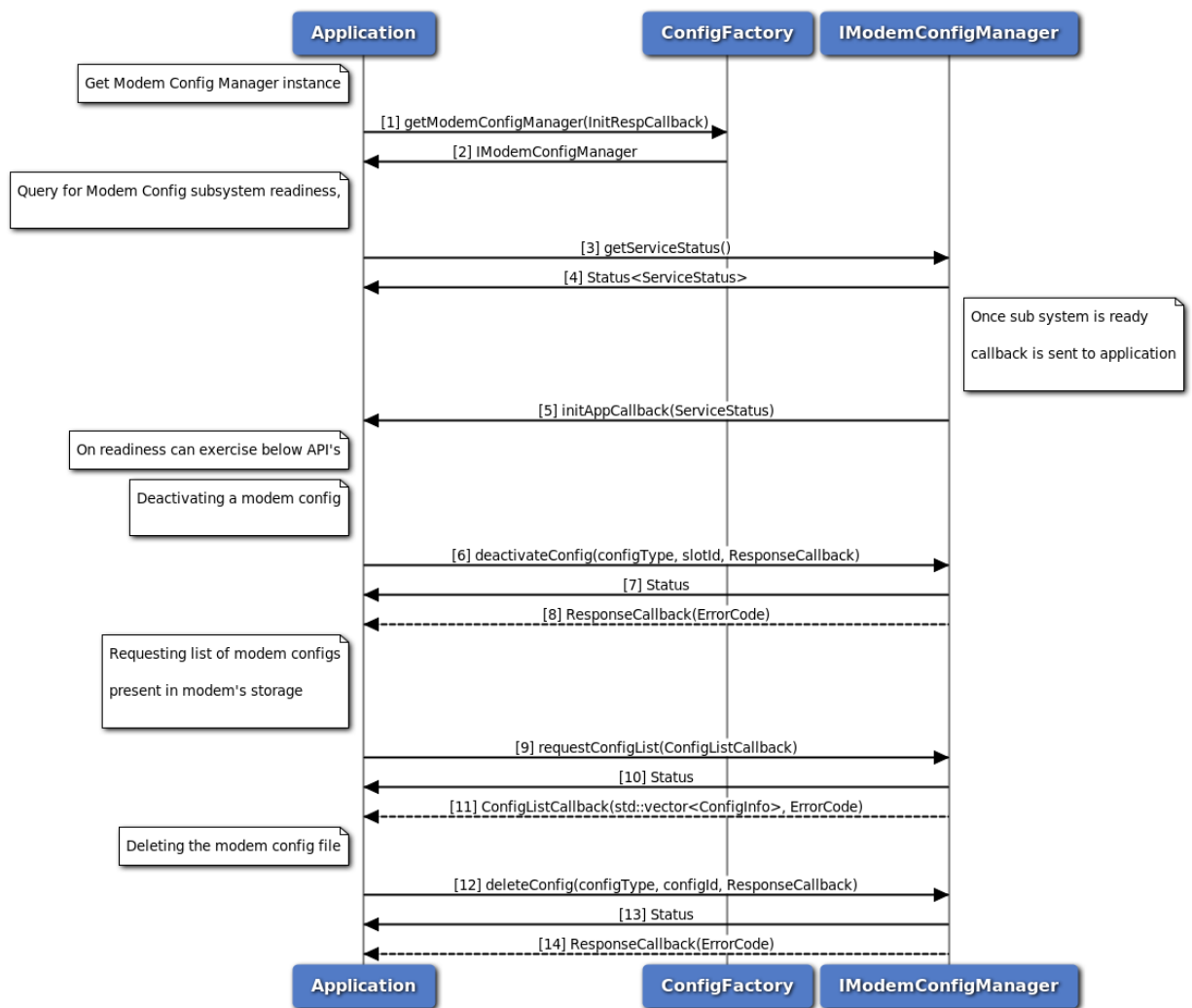

Figure 3-121 Modem Config deactivate and delete Call Flow

1. Application requests Config factory for ModemConfig Manager and passes callback pointer.
2. Config factory return IModemConfigManager object to application.

3. Application can use `IModemConfigManager::getServiceStatus` to determine the state of sub system.
4. The application receives the `ServiceStatus` of sub system which indicates the state of service.
5. `IModemConfigManager` notifies the application when the subsystem is ready through the callback mechanism.
6. Application sends a request to deactivate config file.
7. Application receives synchronous `Status` which indicates if the request to deactivate config file was sent successfully.
8. Application is notified of the `Status` of the `deactivateConfig` request (either `SUCCESS` or `FAILED`) via the application-supplied callback.
9. Application sends a request to get list of all modem configs from modem's storage.
10. Application receives synchronous `Status` which indicates if the request to get config list was sent successfully.
11. Application is notified of the `Status` of the `requestConfigList` request (either `SUCCESS` or `FAILED`) via the application-supplied callback along with list of modem configs.
12. Application sends a request to delete config file.
13. Application receives synchronous `Status` which indicates if the request to delete config file was sent successfully.
14. Application is notified of the `Status` of the `deleteConfig` request (either `SUCCESS` or `FAILED`) via the application-supplied callback.



### 3.9.3 Call flow to set and get config auto selection mode

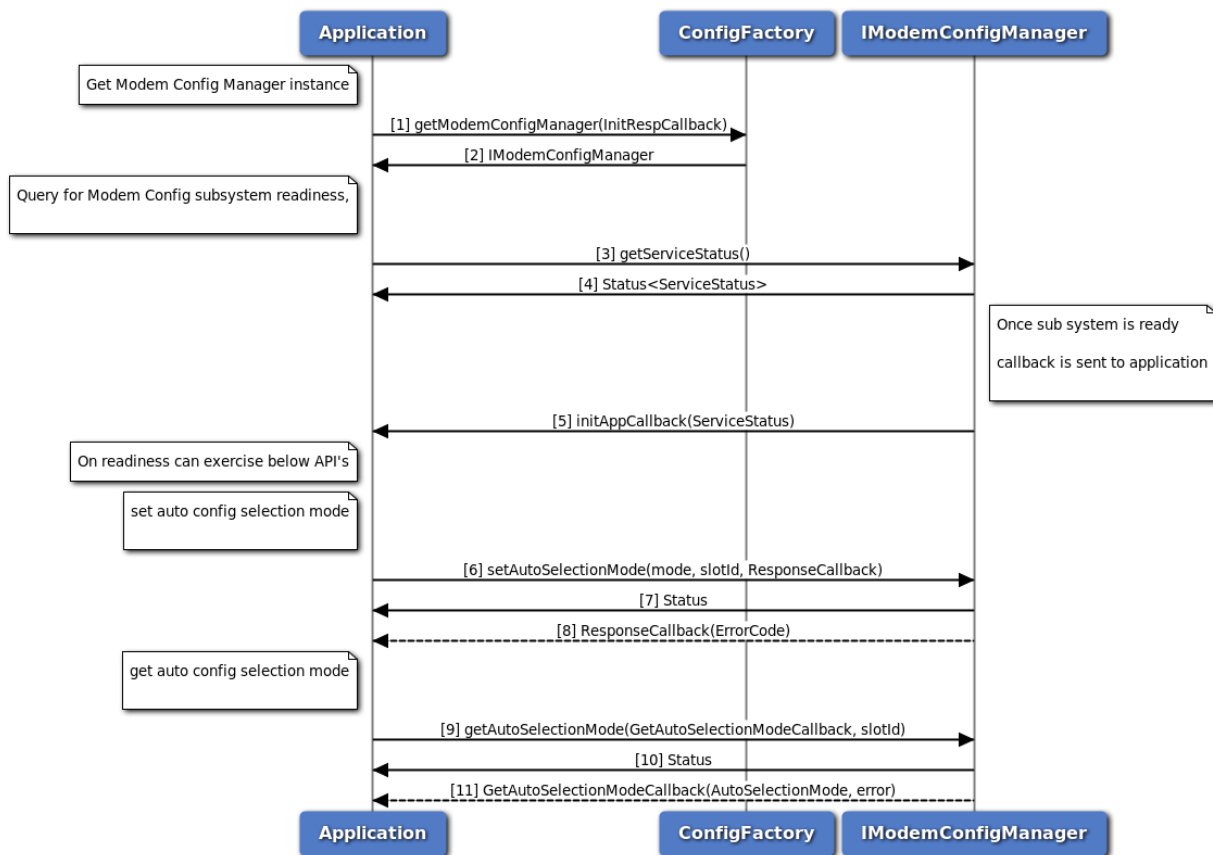

**Figure 3-122 Modem Config get and set Auto Selection Mode Call Flow**

1. Application requests Config factory for ModemConfig Manager and passes callback pointer.
2. Config factory return IModemConfigManager object to application.
3. Application can use IModemConfigManager::getServiceStatus to determine the state of sub system.
4. The application receives the ServiceStatus of sub system which indicates the state of service.
5. IModemConfigManager notifies the application when the subsystem is ready through the callback mechanism.
6. Application sends a request to set config auto selection mode.
7. Application receives synchronous Status which indicates if the request to set config auto selection mode was sent successfully.
8. Application is notified of the Status of the request setAutoSelectionMode (either SUCCESS or FAILED) via the application-supplied callback.
9. Application sends a request to get config auto selection mode.
10. Application receives synchronous Status which indicates if the request to get config auto selection mode was sent successfully.

11. Application is notified of the Status of the request setAutoSelectionMode (either SUCCESS or FAILED) via the application-supplied callback, along with mode and slot id.

### 3.10 Sensor

The sensor sub-system provides APIs to configure and acquire continuous stream of data from an underlying sensor, create multiple clients for a given sensor, each of which can have their own configuration (sampling rate, batch count) for data acquisition.

The sensor sub-system APIs are synchronous in nature.

#### 3.10.1 Call flow for sensor sub-system start-up

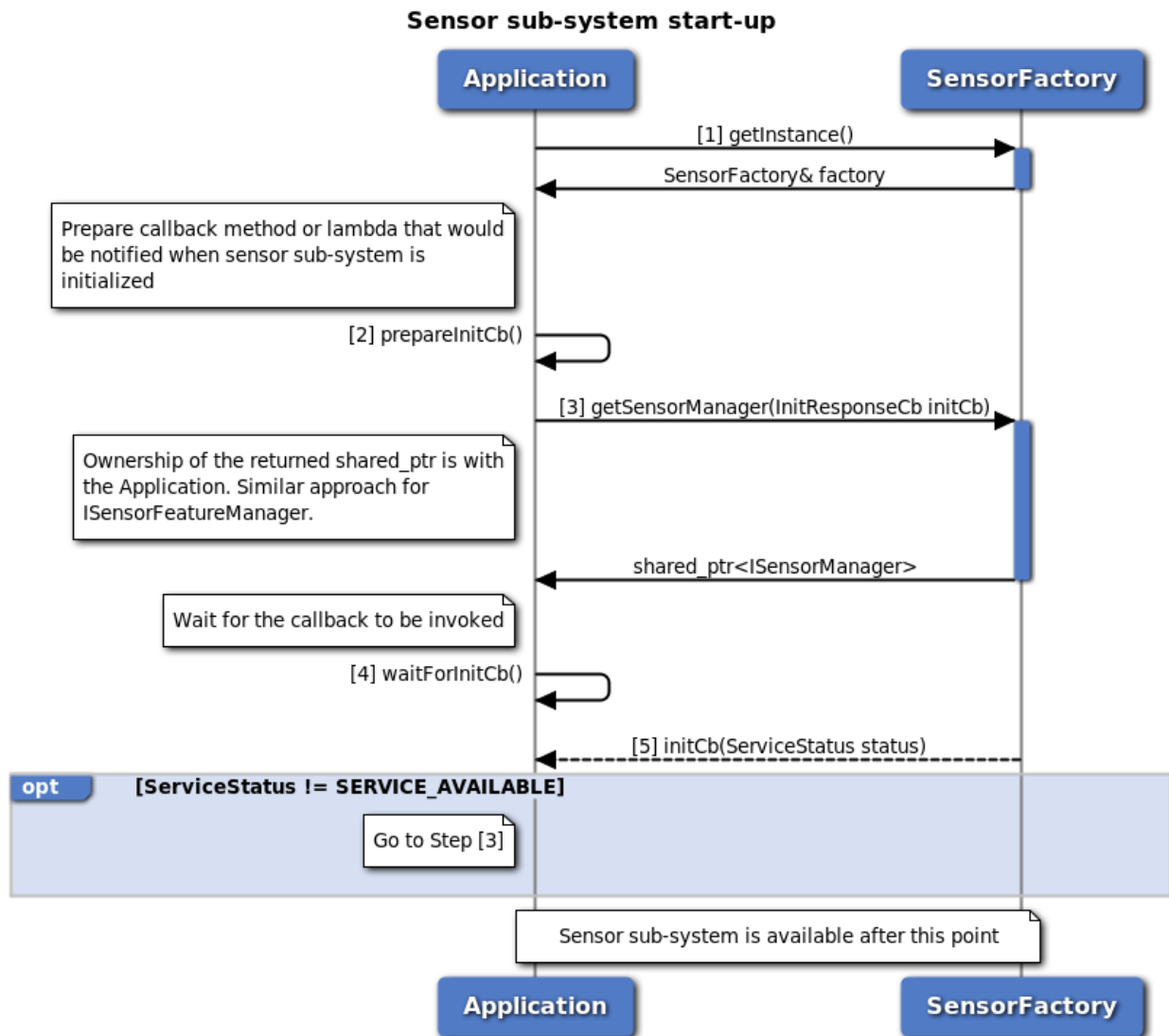

Figure 3-123 Sensor sub-system start-up call flow

1. Get the reference to the SensorFactory, with which we can further acquire other sensor sub-system objects.
2. Prepare an initialization callback method or lambda which will be called by the sensor sub-system once the initialization is complete.
3. Request for the SensorManager from SensorFactory and provide the initialization callback. Retain the SensorManager shared\_ptr as long as necessary. SensorFactory does not hold on to the returned instance. If the received shared\_ptr is released, SensorManager would be destroyed and requesting SensorFactory for SensorManager again would result in the creation of a new instance. Similar is the approach for SensorFeatureManager.
4. Wait for the initialization callback to be invoked.
5. The sensor sub-system invokes the callback once the underlying sub-system and sensor framework is available for usage. If the service status is notified as SERVICE\_FAILED, retry initialization starting with step (3). If the service status is notified as SERVICE\_AVAILABLE, the sensor sub-system is ready for usage.

### 3.10.2 Call flow for sensor data acquisition

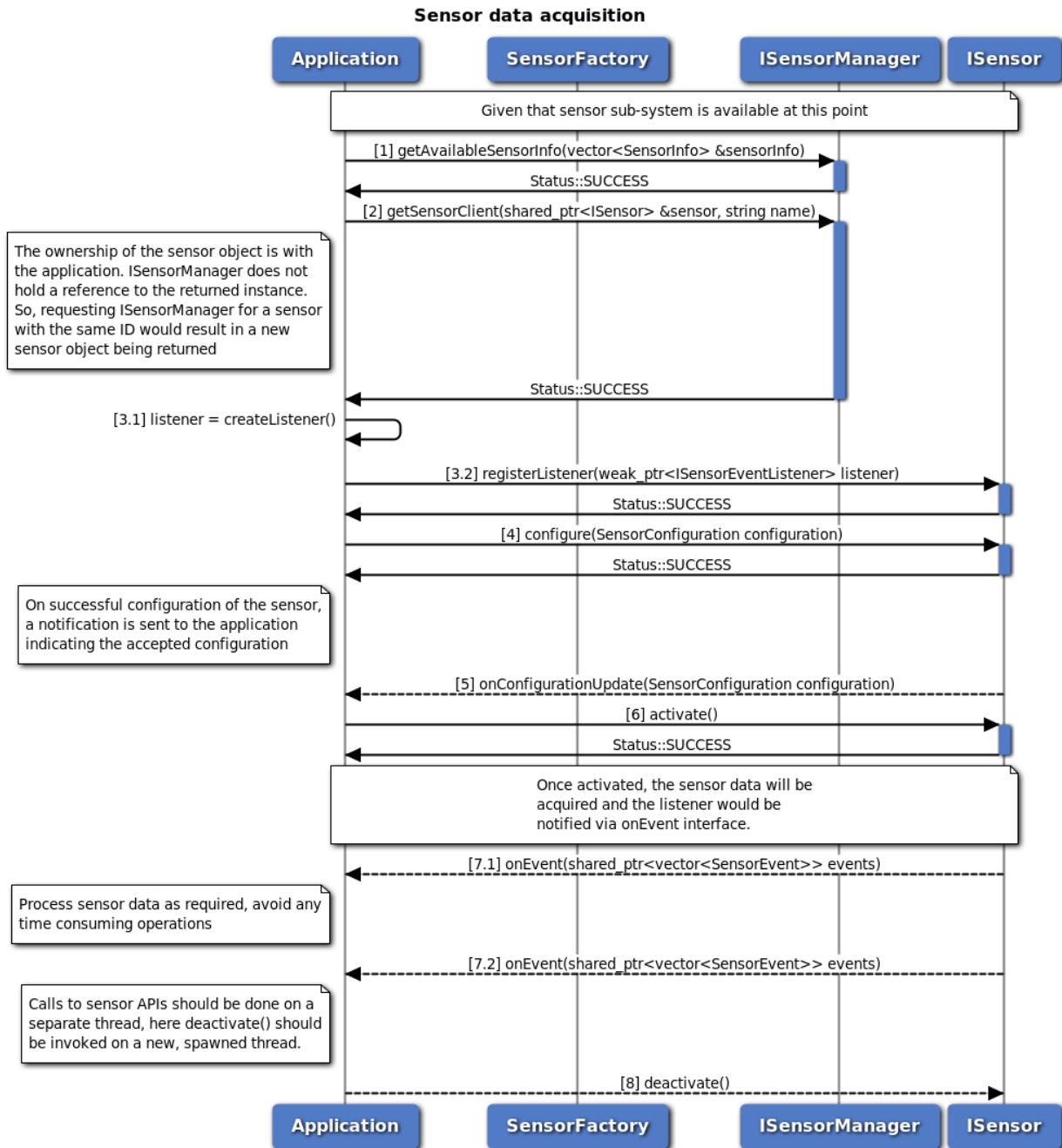

Figure 3-124 Sensor data acquisition call flow

The sensor sub-system should have been initialized successfully with SERVICE\_AVAILABLE as a pre-requisite for sensor data acquisition and a valid SensorManager object is available.

1. Get the information about available sensors from ISensorManager. The information will be provided in the sensorInfo parameter that would be passed by reference.
2. Given the information about different sensors, identify the required sensor (name of the sensor) using

the provided attributes - type, name, vendor or required sampling frequency. Having identified the required sensor, request for the sensor object from ISensorManager with the required name of the sensor. If the request was successful, the provided reference to `shared_ptr<ISensorClient>` would be set by the ISensorManager which can be used to further configure and acquire data from the sensor. The ownership of the sensor object is with the application. SensorManager does not hold a reference to the returned instance. So, requesting ISensorManager for a sensor with the same name would result in a new sensor object being returned.

3. Create a listener of type ISensorEventListener which would receive notifications about updates to sensor configuration and sensor events. Register the created listener with the sensor object.
4. Create the desired sensor configuration. For continuous data acquisition `samplingRate` and `batchCount` are necessary attributes to be set in the configuration. Be sure to set the `validityMask` in the `SensorConfiguration` structure.
5. On successful configuration, a notification is sent to the registered listeners indicating the configuration set.
6. Activate the sensor for acquiring sensor data.
7. When the sensor is activated successfully, the sensor data is sent to the registered listeners.

### 3.10.3 Call flow for sensor reconfiguration

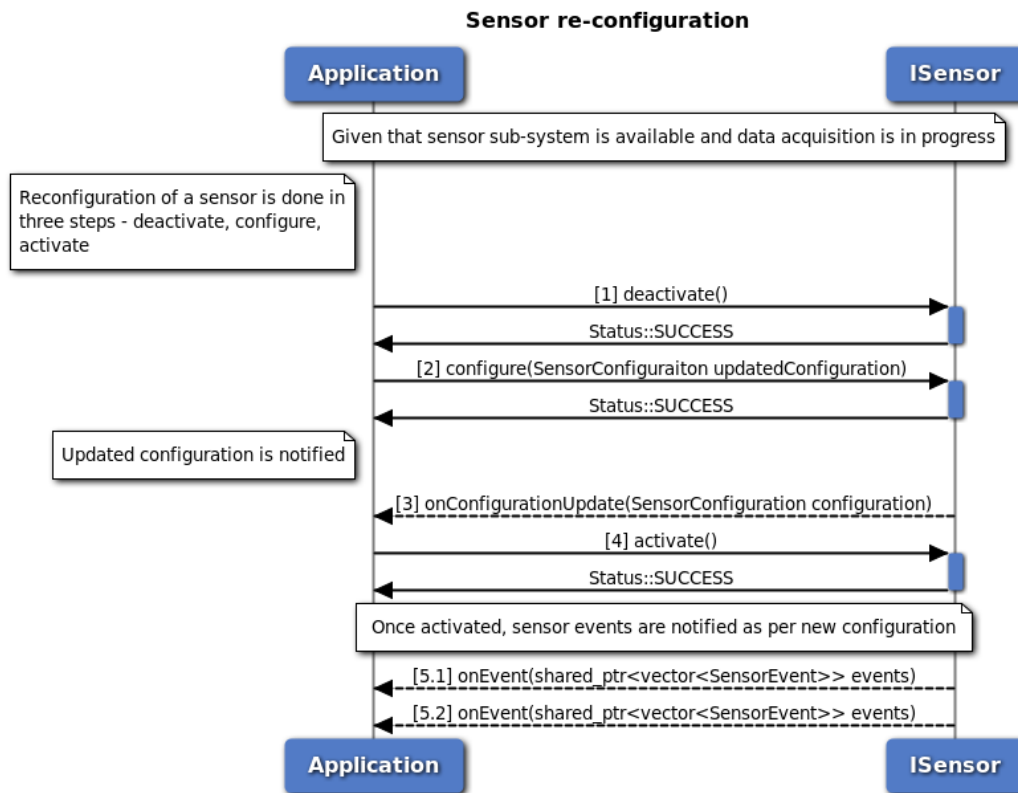
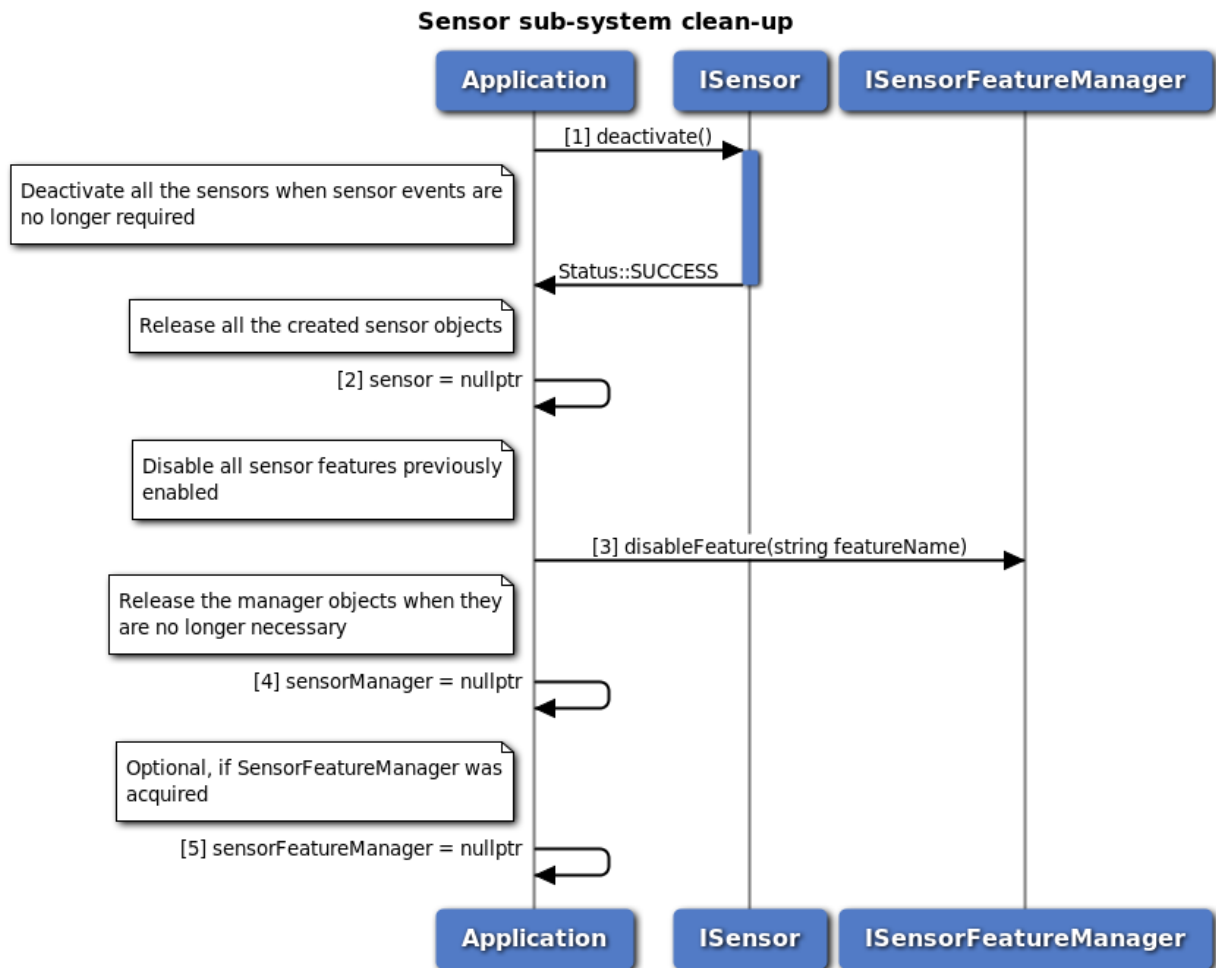

**Figure 3-125 Sensor reconfiguration call flow**

When the sensor sub-system has been initialized successfully with `SERVICE_AVAILABLE` and is already activated, reconfiguring the sensors involves the following steps.

1. Deactivate the sensor. This will stop the notifications about sensor events to the registered listeners.
2. Configure the sensor with the required attributes. Be sure to set the validityMask for the all required attributes in SensorConfiguration.
3. The underlying sub-system notifies the registered listeners about the new configuration set.
4. Activate the sensor.
5. When the sensor is activated successfully, the sensor data is sent to the registered listeners as per the new configuration.

### 3.10.4 Call flow for sensor sub-system cleanup



**Figure 3-126 Sensor sub-system cleanup call flow**

When the sensor sub-system has been initialized successfully with SERVICE\_AVAILABLE and sensor objects have been created, the following steps ensure a cleanup of the sensor sub-system.

1. Deactivate all the sensors. With this, the registered listeners will no longer be notified of the sensor events.
2. Release all the sensor objects created by setting them to nullptr. Since the application owns the

- objects, this would result in all the sensor objects getting destroyed.
3. Disable all the sensor features that were previously enabled.
4. Release the instance of ISensorManager by setting it to nullptr. Since the application owns the object, this would result in the sensor manager getting destroyed.
5. Release the instance of ISensorFeatureManager by setting it to nullptr. Since the application owns the object, this would result in the sensor feature manager getting destroyed.

### 3.10.5 Call flow for sensor power control

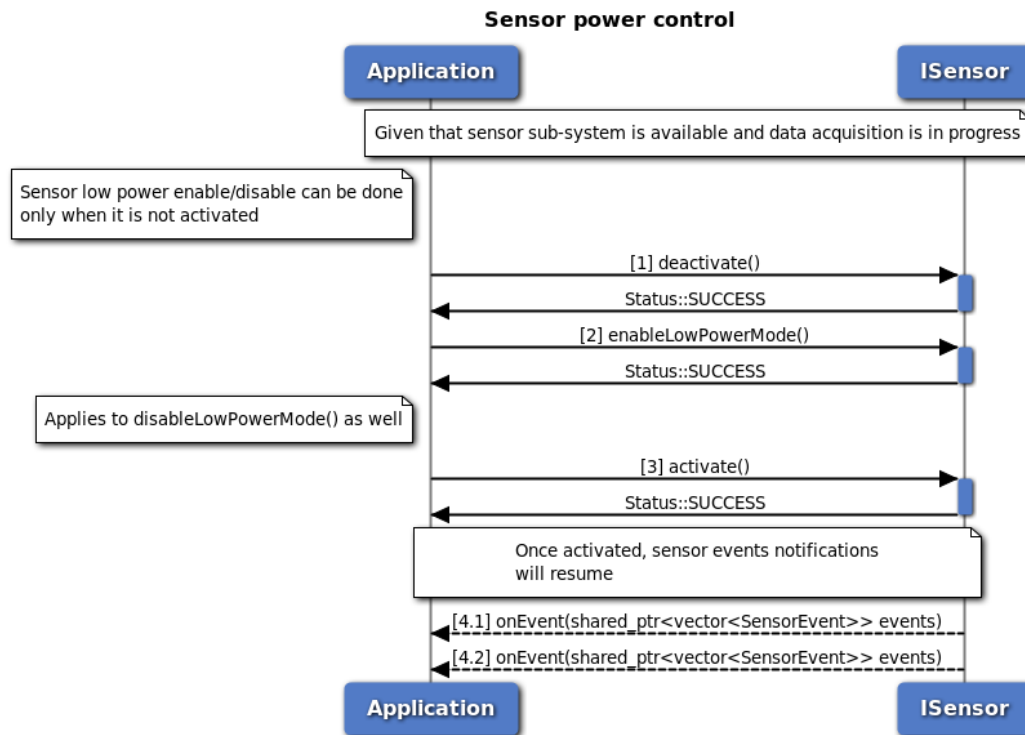

**Figure 3-127 Sensor power control cleanup call flow**

The below points are to be noted for sensor power control a) Power control is not offered by all sensor manufacturers. If the underlying hardware sensor does not support power control, the power control APIs fail. b) Enabling or disabling low power mode for the sensor is only possible when the sensor is not activated.

For achieving power control, the following steps are to be followed

1. Deactivate the sensor. This will stop the notifications about sensor events to the registered listeners.
2. Perform the required power control by enabling or disabling low power mode for the sensor.
3. Activate the sensor.
4. When the sensor is activated successfully, the sensor data is sent to the registered listeners.

### 3.10.6 Call flow for sensor feature control

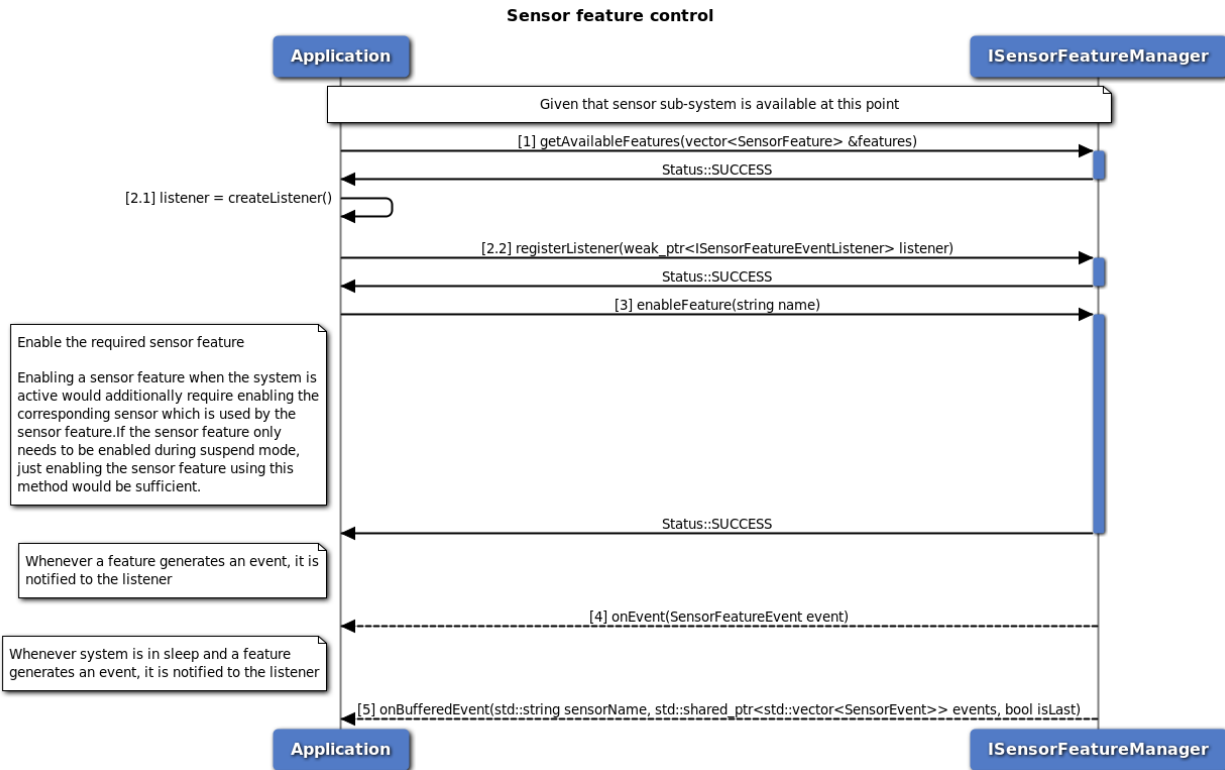

**Figure 3-128 Sensor feature control cleanup call flow**

The sensor sub-system offers certain features in addition to the data acquisition and these could be features offered by the underlying sensor hardware or the sensor software framework. If there are no features offered collectively, the sensor feature manager initialization would fail.

1. Retrieve a list of features offered by the sensor sub-system and identify the required feature that needs to be enabled. If the feature that needs to be enabled is known, this step is optional.
2. Create a sensor feature event listener, which would be notified of the different events that occur. Register this listener with the sensor feature manager.
3. Enable the required feature.
4. If system is not in sleep mode, Once the feature is enabled and an event related to the feature occurs, the listener is notified.
5. If system is in sleep mode, Once the feature is enabled and an event related to the feature occurs, the listener is notified.

## 3.11 Platform

The platform sub-system provides APIs to configure and control platform functionalities. This sub-system provides notifications about certain system related events, for instance filesystem events such as EFS restore and backup events.





### 3.11.1 Call flow for EFS restore notification registration and handling

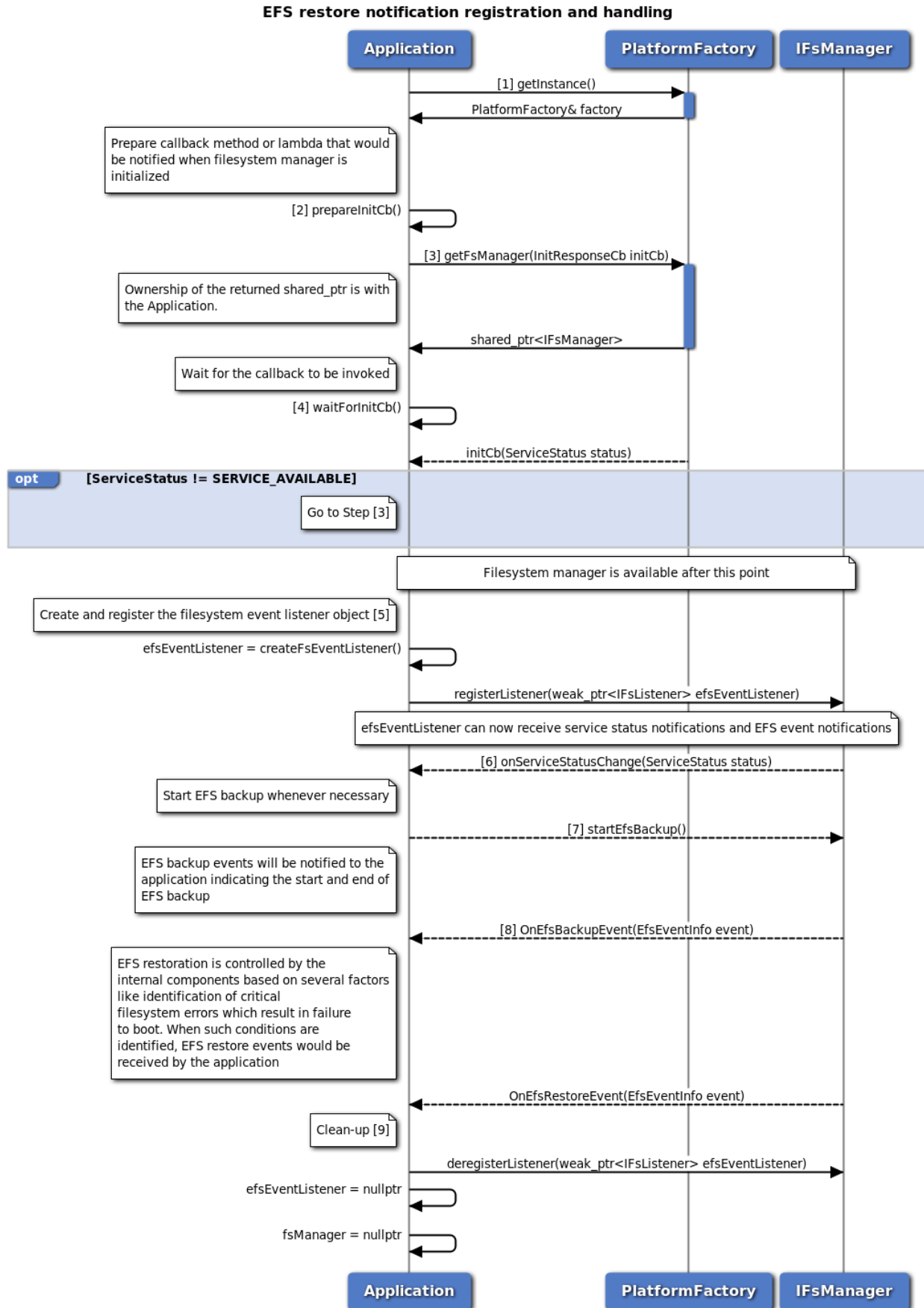
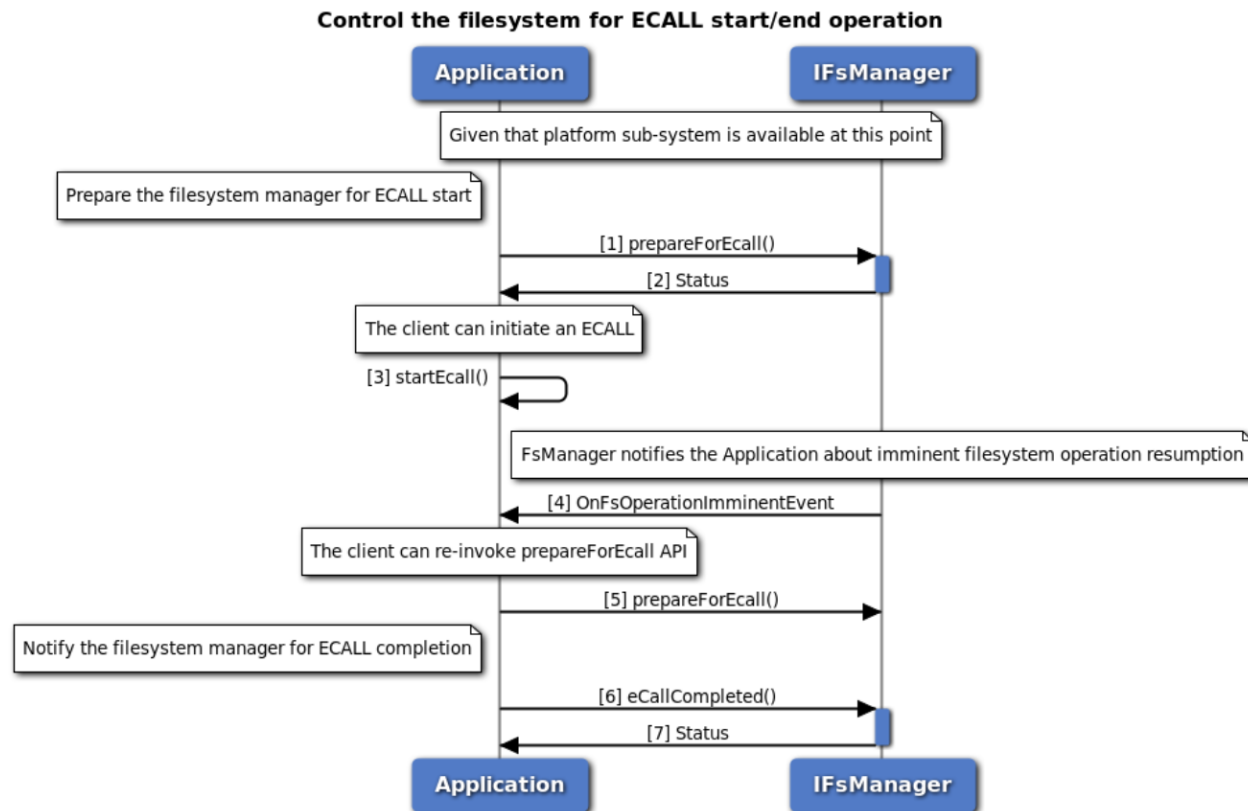

Figure 3-129 EFS restore notification registration and handling call flow

1. Get the reference to the PlatformFactory, with which we can further acquire other sub-system objects.
2. Prepare an initialization callback method or lambda which will be called by the platform sub-system once the initialization is complete.
3. Request for the IFsManager (filesystem manager) object from PlatformFactory and provide the initialization callback. Retain the IFsManager shared\_ptr as long as necessary. PlatformFactory does not hold on to the returned instance. If the received shared\_ptr is released, FsManager would be destroyed and requesting PlatformFactory for FsManager again would result in the creation of a new instance.
4. Wait for the initialization callback to be invoked. The platform sub-system invokes the callback once the underlying sub-system is available for usage. If the service status is notified as SERVICE\_FAILED, retry initialization starting with step (3). If the service status is notified as SERVICE\_AVAILABLE, the filesystem manager is ready for usage.
5. Create an listener object of type IFsListener and register with IFsManager for notifications. Once registered, the listener receives service status notifications and EFS restore event notifications.
6. If a service status notification with status SERVICE\_UNAVAILABLE, the application should wait for service to be re-initialized and once done, SERVICE\_AVAILABLE will be notified. If the service fails, SERVICE\_FAILED is notified and the IFsManager object held is no longer usable. A new object of type IFsManager needs to be re-acquired from the PlatformFactory.
7. When the application finds it appropriate to trigger a EFS backup, startEfsBackup should be invoked, which would return immediately indicating the status of the request
8. Once EFS backup starts and completes, the notifications are sent out to the application. EFS restoration is controlled by the internal components based on several factors like identification of critical filesystem errors which result in failure to boot. When such conditions are identified, EFS restore events would be received by the application via the OnEfsRestoreEvent method and the application can make use of the information appropriately. The EFS restore notification also has information if the restore started or ended and if the restore was successful or a failure.
9. Once clean-up is necessary, deregister the registered listener, set all shared pointers to nullptr. This will make the underlying sub-system relinquish resources that are no longer necessary.

### 3.11.2 Call flow of control filesystem for ECALL operation

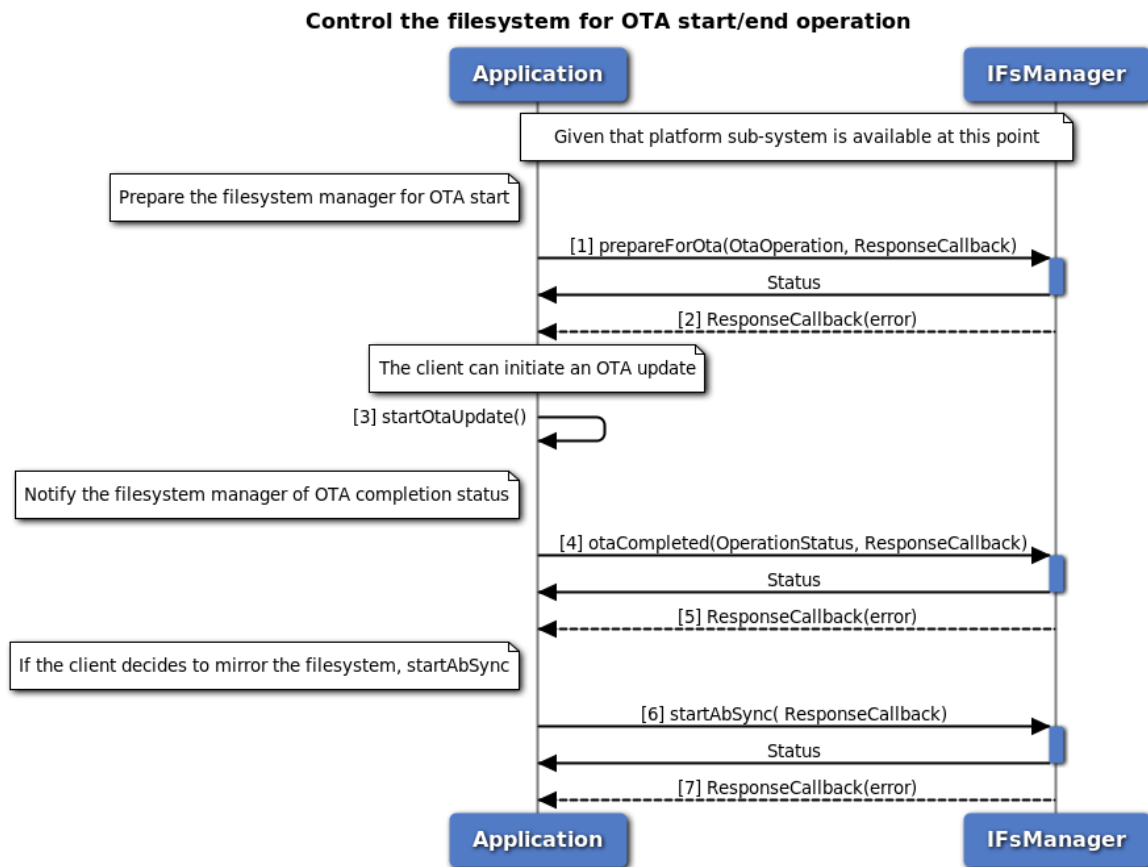

**Figure 3-130 Control the filesystem for ECALL operation call flow**

The platform sub-system should have been initialized successfully with SERVICE\_AVAILABLE as a pre-requisite for any filesystem operations and a valid FilesystemManager object is available.

1. Before initiate an eCall, the application should prepare the filesystem for eCall operation, prepareForEcall should be invoked. If the status of this request fails, the client could re-invoke during an eCall ongoing.
2. The status of the request would return immediately indicating the preparation of the filesystem operation.
3. The client should start an eCall immediately even if the prepare for eCall request failed.
4. The filesystem manager shall notify the application when filesystem operation is about to resume.
5. If the client wants to suspend the filesystem operation to continue the eCall, they should invoke the prepareForEcall API.
6. Once an eCall completes, the client should notify eCall completion to the filesystem manager. eCallCompleted should be invoked.
7. The status of the request would return immediately indication the completion of the filesystem operation.

### 3.11.3 Call flow of control filesystem for OTA operation



**Figure 3-131 Control the filesystem for OTA operation call flow**

The platform sub-system should have been initialized successfully with `SERVICE_AVAILABLE` as a pre-requisite for any filesystem operations and a valid `FileManager` object is available.

1. Before initiate an OTA update, the application should prepare the filesystem for the OTA operation, `prepareForOta` should be invoked, which would return immediately indicating the status of the request.
2. Once the filesystem has prepared for the OTA operation, the filesystem manager would invoke the callback which indicates the response of the API.
3. Once the filesystem has prepared for the OTA operation, the client could initiate an OTA update.
4. On OTA update completion, the client should notify the filesystem manager of the OTA completion status, `otaCompleted` should be invoked, which would return immediately indicating the status of the request.
5. The filesystem manager would intern update the OTA status, the callback would invoked which indicates the response of the API.
6. If the client decides to mirror the system, `startAbSync` should be invoked which would return immediately indicating the status of the request.

- Once the filesystem partition sync operation complete, the filesystem manager would invoke the callback which indicates the response of the API.

### 3.11.4 Call flow for sensor self test

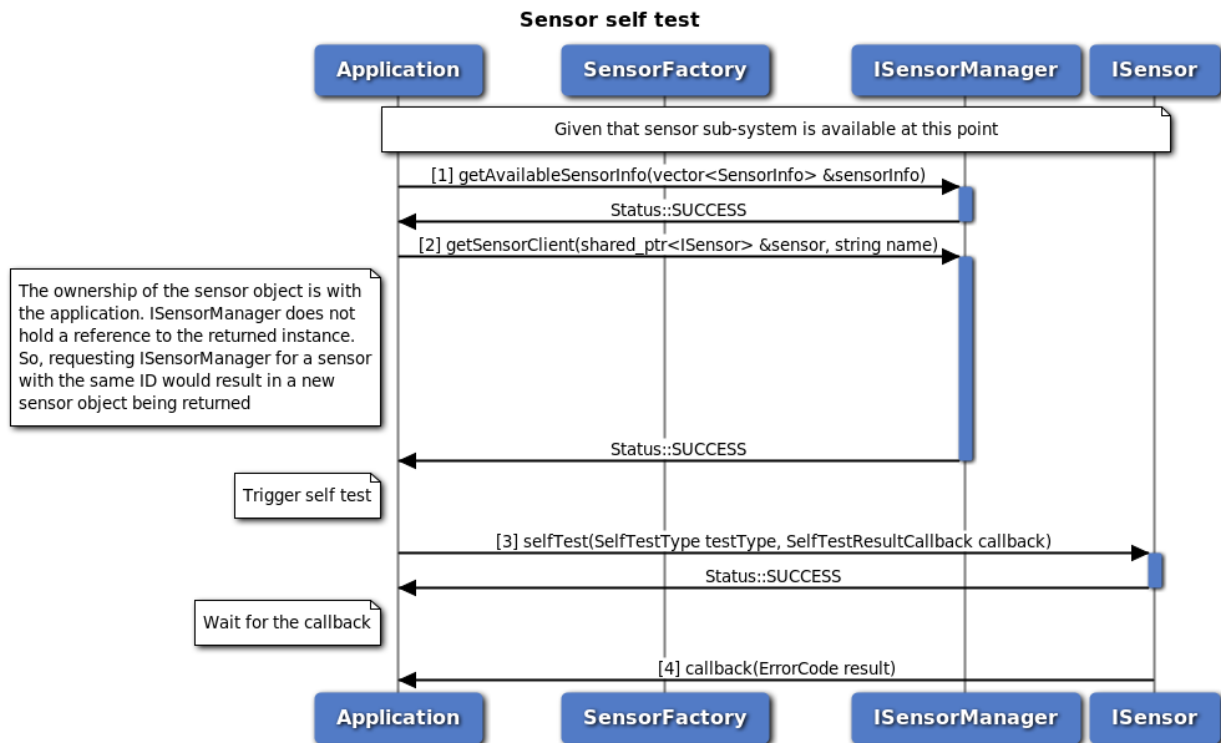

**Figure 3-132 Sensor self test call flow**

Certain sensors offer self test feature which can be invoked whenever needed by the application using the selfTest API. The sensor sub-system should have been initialized successfully with SERVICE\_AVAILABLE as a pre-requisite for sensor data acquisition and a valid SensorManager object is available.

- Get the information about available sensors from ISensorManager. The information will be provided in the sensorInfo parameter that would be passed by reference.
- Given the information about different sensors, identify the required sensor (name of the sensor) using the provided attributes - type, name, vendor or required sampling frequency. Having identified the required sensor, request for the sensor object from ISensorManager with the required name of the sensor. If the request was successful, the provided reference to shared\_ptr<ISensorClient> would be set by the ISensorManager which can be used to further configure and acquire data from the sensor. The ownership of the sensor object is with the application. SensorManager does not hold a reference to the returned instance. So, requesting ISensorManager for a sensor with the same name would result in a new sensor object being returned.
- Trigger the self test with the require self test type and provide a callback that would be invoked by the sensor framework once the self test is completed.
- Once the self test is completed, the callback gets invoked indicating the result of the self test.

## 3.12 Security Management

### 3.12.1 Crypto

The CryptoManager class provides APIs to generate, import, export and upgrade key based on various cryptographic algorithms. Data can be signed and verified using this key. Further data can be encrypted and decrypted with the key.

#### 3.12.1.1 Call flow to generate and export key

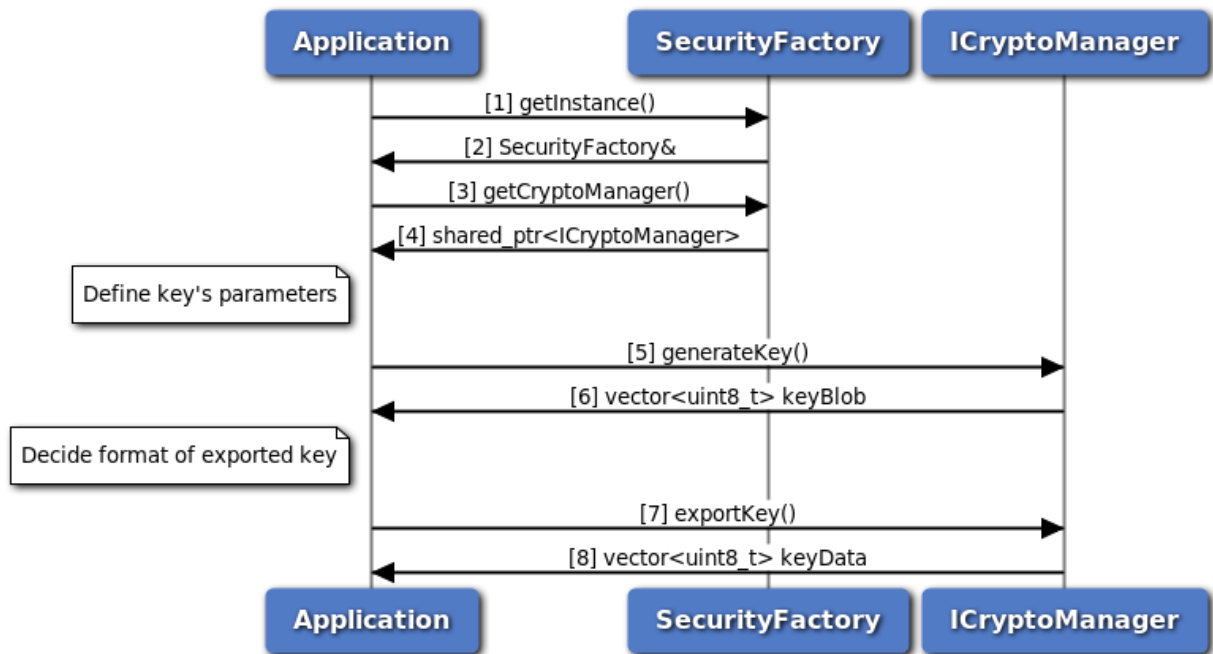

Figure 3-133 Call flow to generate and export key

1. Application request an instance of SecurityFactory.
2. An instance of SecurityFactory is received by the application.
3. From the SecurityFactory, application request an instance of ICryptoManager.
4. An instance of ICryptoManager is received by the application.
5. Application creates an instance of ICryptoParam using CryptoParamBuilder to define input parameters for the key.
6. Application calls generateKey() API of ICryptoManager. Now, the application has a key blob which represents the crypto key. Application should use this key blob for signing, verification, encryption and decryption operations.
7. For a given use-case, if the application wants to extract public key out of the key blob, it can do so by calling export key.
8. ICryptoManager returns key in the format requested for ex; X509.

### 3.12.1.2 Call flow to sign and verify data

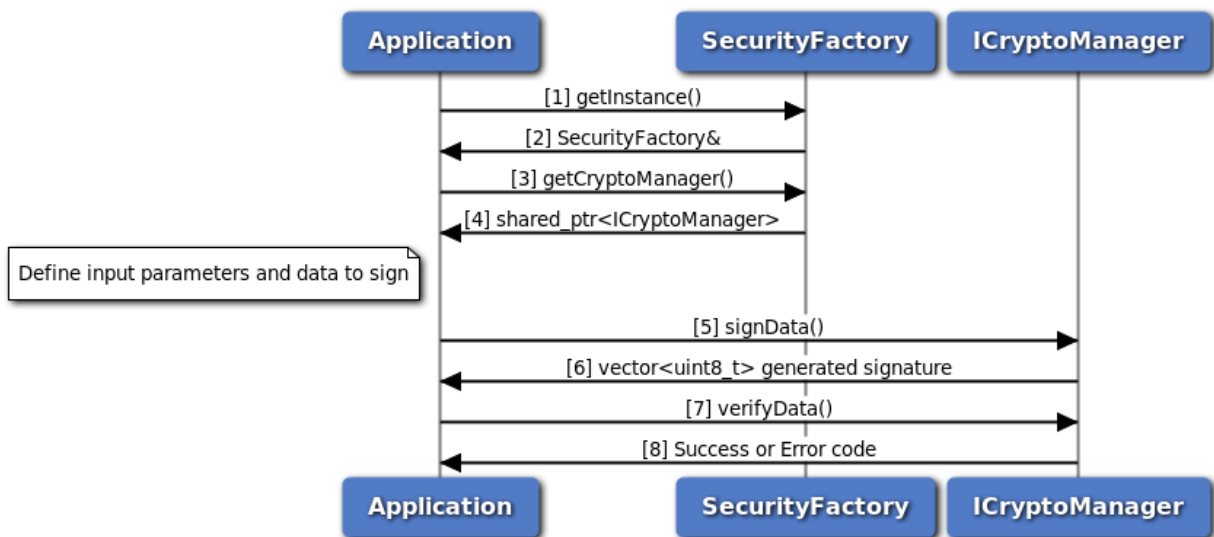
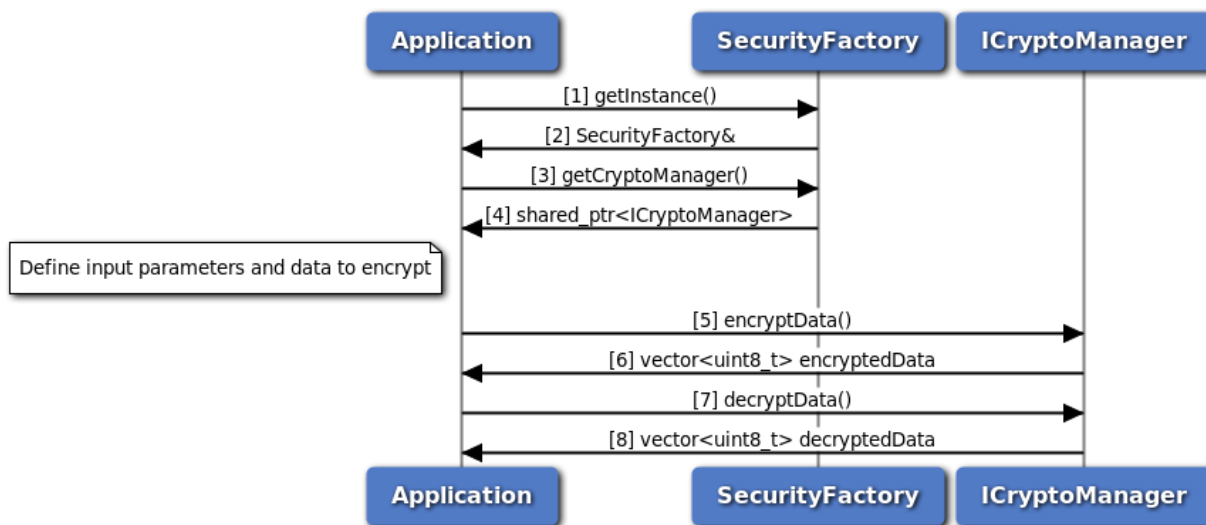

Figure 3-134 Call flow to sign and verify data

1. Application request an instance of SecurityFactory.
2. An instance of SecurityFactory is received by the application.
3. From the SecurityFactory, application request an instance of ICryptoManager.
4. Application creates an instance of ICryptoParam using CryptoParamBuilder to define input parameters for how the signing should occur.
5. Application calls signData() API of ICryptoManager passing the key blob, data to be signed and input parameters.
6. ICryptoManager returns signature corresponding to the inputs given.
7. Application creates an instance of ICryptoParam using CryptoParamBuilder to define input parameters for how the verification should occur.
8. Application calls verifyData() API of ICryptoManager passing the key blob, signature, data to be verified and input parameters.
9. ICryptoManager returns success if the verification succeeds (valid data and signature) otherwise appropriate error code.



### 3.12.1.3 Call flow to encrypt and decrypt data



**Figure 3-135 Call flow to encrypt and decrypt data**

1. Application request an instance of SecurityFactory.
2. An instance of SecurityFactory is received by the application.
3. From the SecurityFactory, application request an instance of ICryptoManager.
4. Application creates an instance of ICryptoParam using CryptoParamBuilder to define input parameters for how the encryption should occur.
5. Application calls `encryptData()` API of ICryptoManager passing the key blob, data to be encrypted and input parameters.
6. ICryptoManager returns encrypted data corresponding to the inputs given.
7. Application creates an instance of ICryptoParam using CryptoParamBuilder to define input parameters for how the decryption should occur.
8. Application calls `decryptData()` API of ICryptoManager passing the key blob, encrypted data and input parameters.
9. ICryptoManager returns decrypted data otherwise appropriate error code.

### 3.12.2 Crypto Accelerator

The ICryptoAcceleratorManager provides APIs to verify signature and do ECQV calculation based on elliptic-curve cryptography.

### 3.12.2.1 Call flow for signature verification synchronous mode

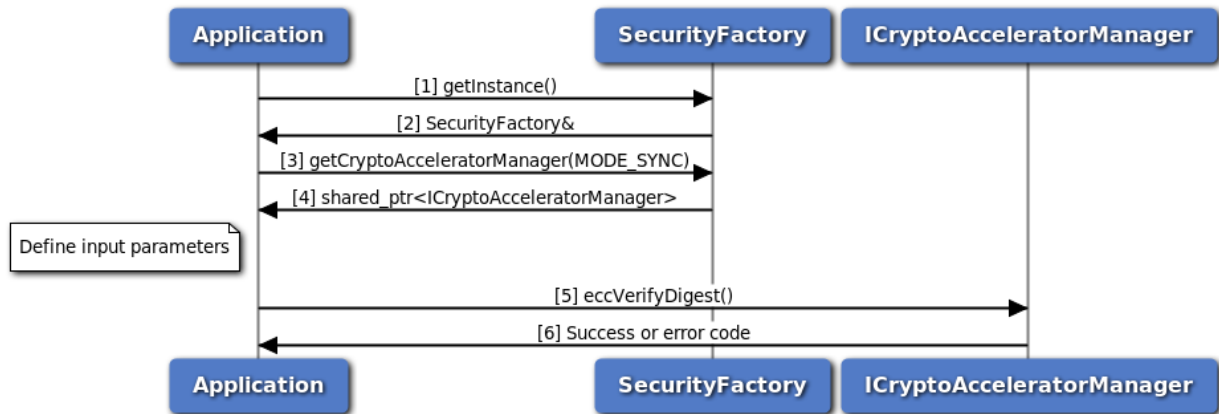

Figure 3-136 Call flow for signature verification synchronous mode

1. Application request an instance of SecurityFactory.
2. An instance of SecurityFactory is received by the application.
3. From the SecurityFactory, application request an instance of ICryptoAcceleratorManager.
4. An instance of ICryptoAcceleratorManager is received by the application.
5. Application defines input parameters for verification.
6. Application calls eccVerifyDigest() API of ICryptoAcceleratorManager.
7. ICryptoAcceleratorManager returns success if verification passed otherwise appropriate error code.

### 3.12.2.2 Call flow for signature verification asynchronous poll mode

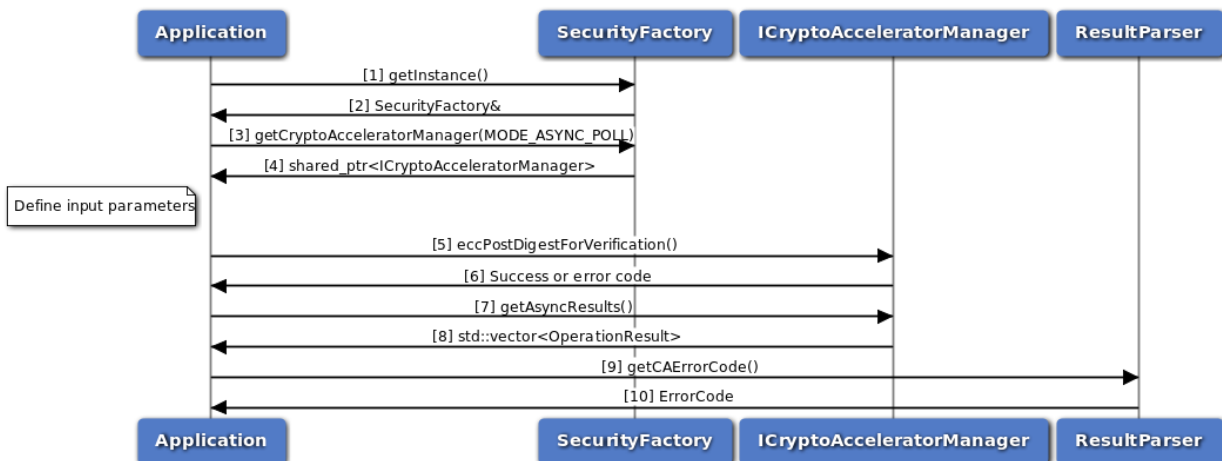

Figure 3-137 Call flow for signature verification asynchronous poll mode

1. Application request an instance of SecurityFactory.

2. An instance of SecurityFactory is received by the application.
3. From the SecurityFactory, application request an instance of ICryptoAcceleratorManager.
4. An instance of ICryptoAcceleratorManager is received by the application.
5. Application defines input parameters for verification.
6. Application calls eccPostDigestForVerification() API of ICryptoAcceleratorManager.
7. ICryptoAcceleratorManager returns success if data is sent for verification.
8. Application calls getAsyncResult() API of ICryptoAcceleratorManager to get the results.
9. ICryptoAcceleratorManager returns verification data obtained from crypto accelerator.
10. Application calls various APIs of ResultParser to get exact verification result.

### 3.12.2.3 Call flow for signature verification asynchronous listener mode

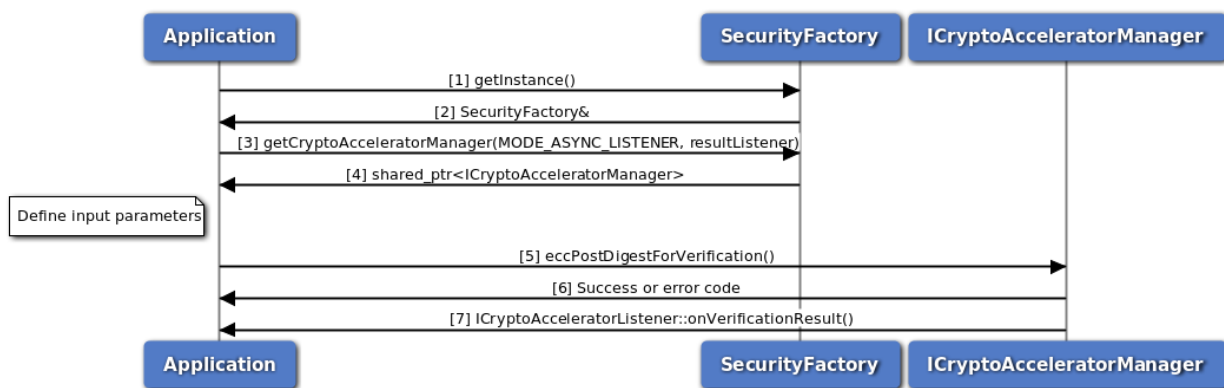

Figure 3-138 Call flow for signature verification asynchronous listener mode

1. Application request an instance of SecurityFactory.
2. An instance of SecurityFactory is received by the application.
3. From the SecurityFactory, application request an instance of ICryptoAcceleratorManager.
4. An instance of ICryptoAcceleratorManager is received by the application.
5. Application defines input parameters for verification.
6. Application calls eccPostDigestForVerification() API of ICryptoAcceleratorManager.
7. ICryptoAcceleratorManager returns success if data is sent for verification.
8. Application receives result in method onVerificationResult() of class implementing ICryptoAcceleratorListener interface.

### 3.12.2.4 Call flow for ECQV calculation synchronous mode

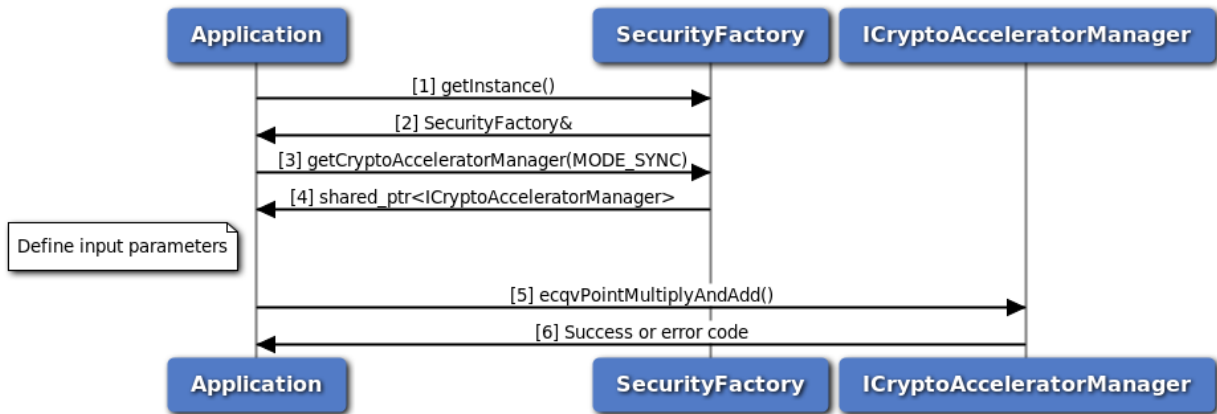

Figure 3-139 Call flow for ECQV calculation synchronous mode

1. Application request an instance of SecurityFactory.
2. An instance of SecurityFactory is received by the application.
3. From the SecurityFactory, application request an instance of ICryptoAcceleratorManager.
4. An instance of ICryptoAcceleratorManager is received by the application.
5. Application defines input parameters for calculation.
6. Application calls ecqvPointMultiplyAndAdd() API of ICryptoAcceleratorManager.
7. ICryptoAcceleratorManager returns success if calculation result otherwise appropriate error code.

### 3.12.2.5 Call flow for ECQV calculation asynchronous poll mode

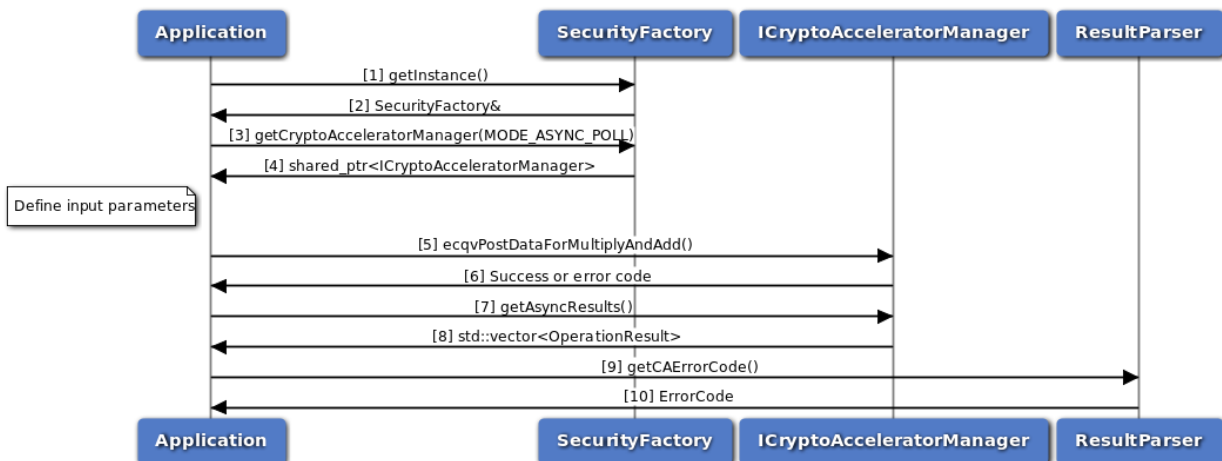

Figure 3-140 Call flow for ECQV calculation asynchronous poll mode

1. Application request an instance of SecurityFactory.

2. An instance of SecurityFactory is received by the application.
3. From the SecurityFactory, application request an instance of ICryptoAcceleratorManager.
4. An instance of ICryptoAcceleratorManager is received by the application.
5. Application defines input parameters for calculation.
6. Application calls ecqvPostDataForMultiplyAndAdd() API of ICryptoAcceleratorManager.
7. ICryptoAcceleratorManager returns success if data is sent for calculation.
8. Application calls getAsyncResult() API of ICryptoAcceleratorManager to get the results.
9. ICryptoAcceleratorManager returns calculation data obtained from crypto accelerator.
10. Application calls various APIs of ResultParser to get exact calculation result.

### 3.12.2.6 Call flow for ECQV calculation asynchronous listener mode

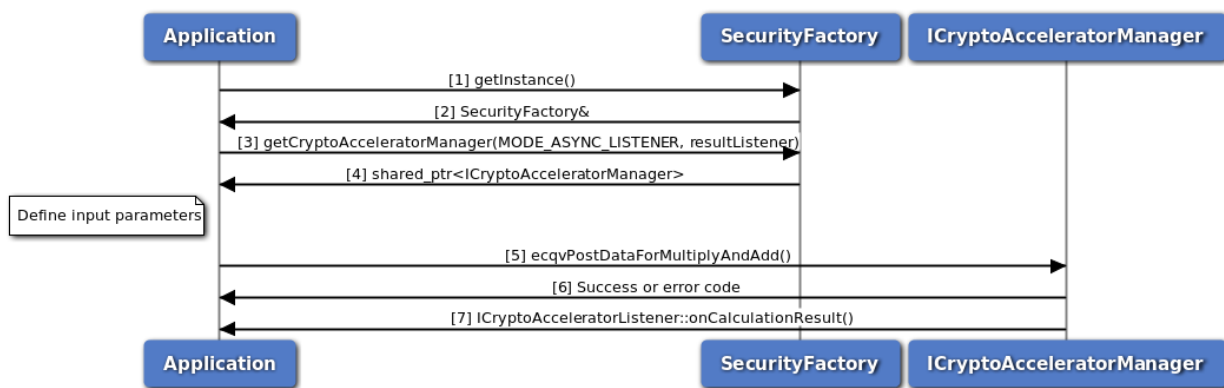

Figure 3-141 Call flow for ECQV calculation asynchronous listener mode

1. Application request an instance of SecurityFactory.
2. An instance of SecurityFactory is received by the application.
3. From the SecurityFactory, application request an instance of ICryptoAcceleratorManager.
4. An instance of ICryptoAcceleratorManager is received by the application.
5. Application defines input parameters for calculation.
6. Application calls ecqvPostDataForMultiplyAndAdd() API of ICryptoAcceleratorManager.
7. ICryptoAcceleratorManager returns success if data is sent for calculation.
8. Application receives result in method onCalculationResult() of class implementing ICryptoAcceleratorListener interface.

### 3.12.3 Cellular Connection Security

The ICellularSecurityManager provides support for detecting, monitoring and generating security threat scan report for cellular connections.

### 3.12.3.1 Call flow to register listener and receive reports

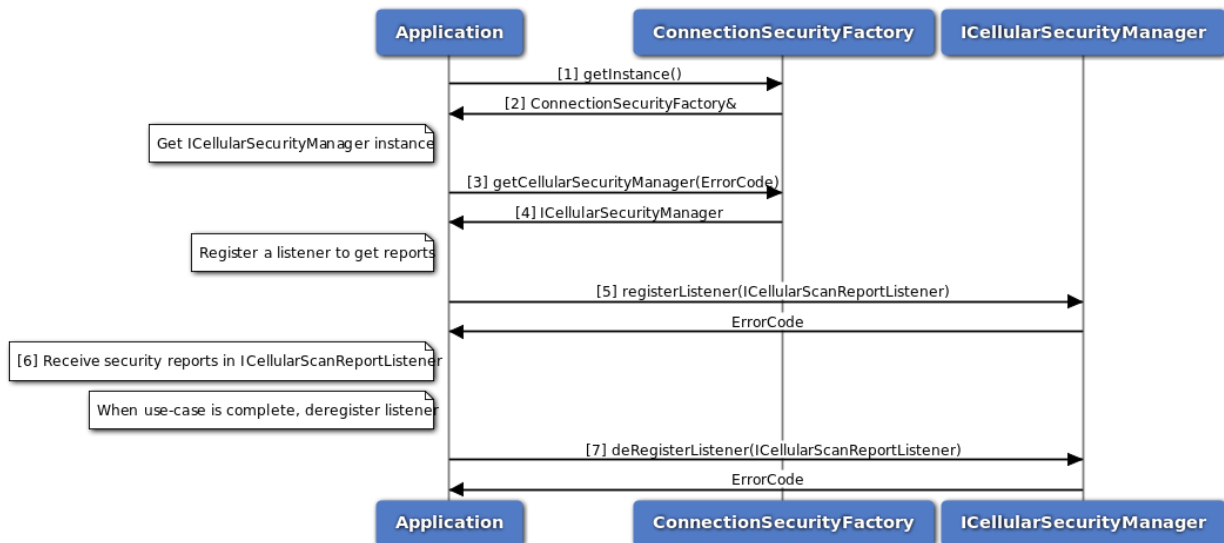

**Figure 3-142 Call flow to register listener and receive reports**

1. Application request an instance of ConnectionSecurityFactory.
2. An instance of ConnectionSecurityFactory is received by the application.
3. From the ConnectionSecurityFactory, application request an instance of ICellularSecurityManager.
4. An instance of ICellularSecurityManager is received by the application.
5. Application registers CellSecurityReportListener listener with ICellularSecurityManager.
6. Application receives security reports in onScanReportAvailable() callback method in CellSecurityReportListener listener.
7. When use-case is complete application deregisters CellSecurityReportListener listener.

### 3.12.4 Wifi connection security

The IWiFiSecurityManager provides support for detecting, monitoring and generating security threat report for WiFi connections.

### 3.12.4.1 Call flow to register listener and receive reports

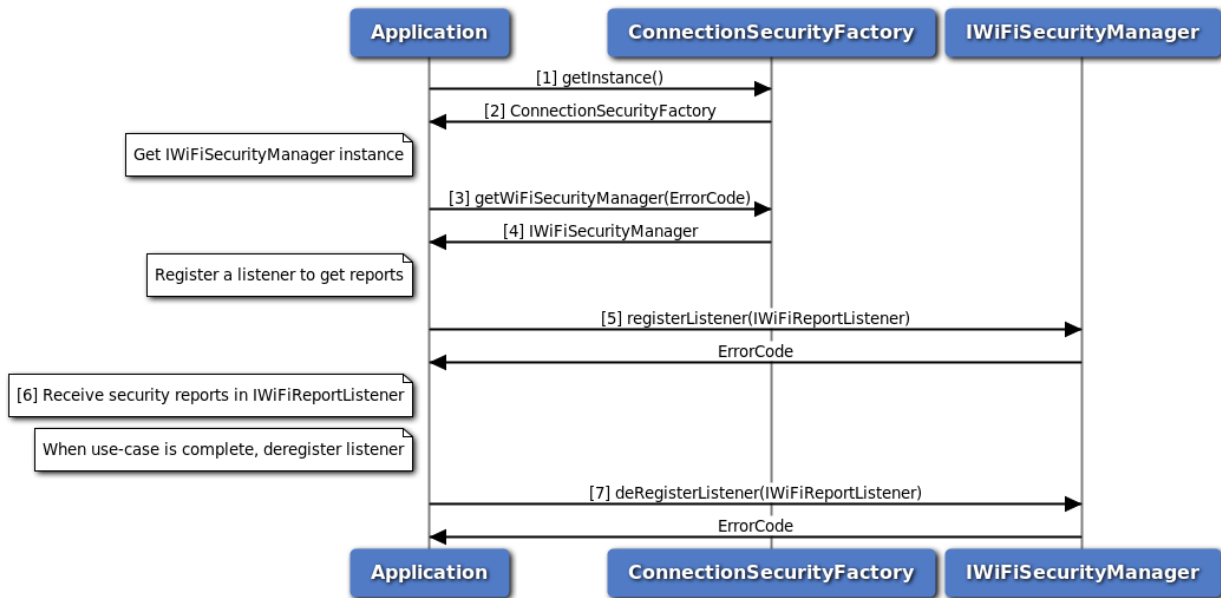

**Figure 3-143 Call flow to register listener and receive reports**

1. Application request an instance of ConnectionSecurityFactory.
2. An instance of ConnectionSecurityFactory is received by the application.
3. From the ConnectionSecurityFactory, application request an instance of IWIFISecurityManager.
4. An instance of IWIFISecurityManager is received by the application.
5. Application registers IWIFIReportListener listener with IWIFISecurityManager.
6. Application receives security reports in onReportAvailable() callback method in IWIFIReportListener listener.
7. When use-case is complete application deregisters IWIFIReportListener listener.

## 3.13 WLAN

### 3.13.1 Call flow to modify WLAN configuration

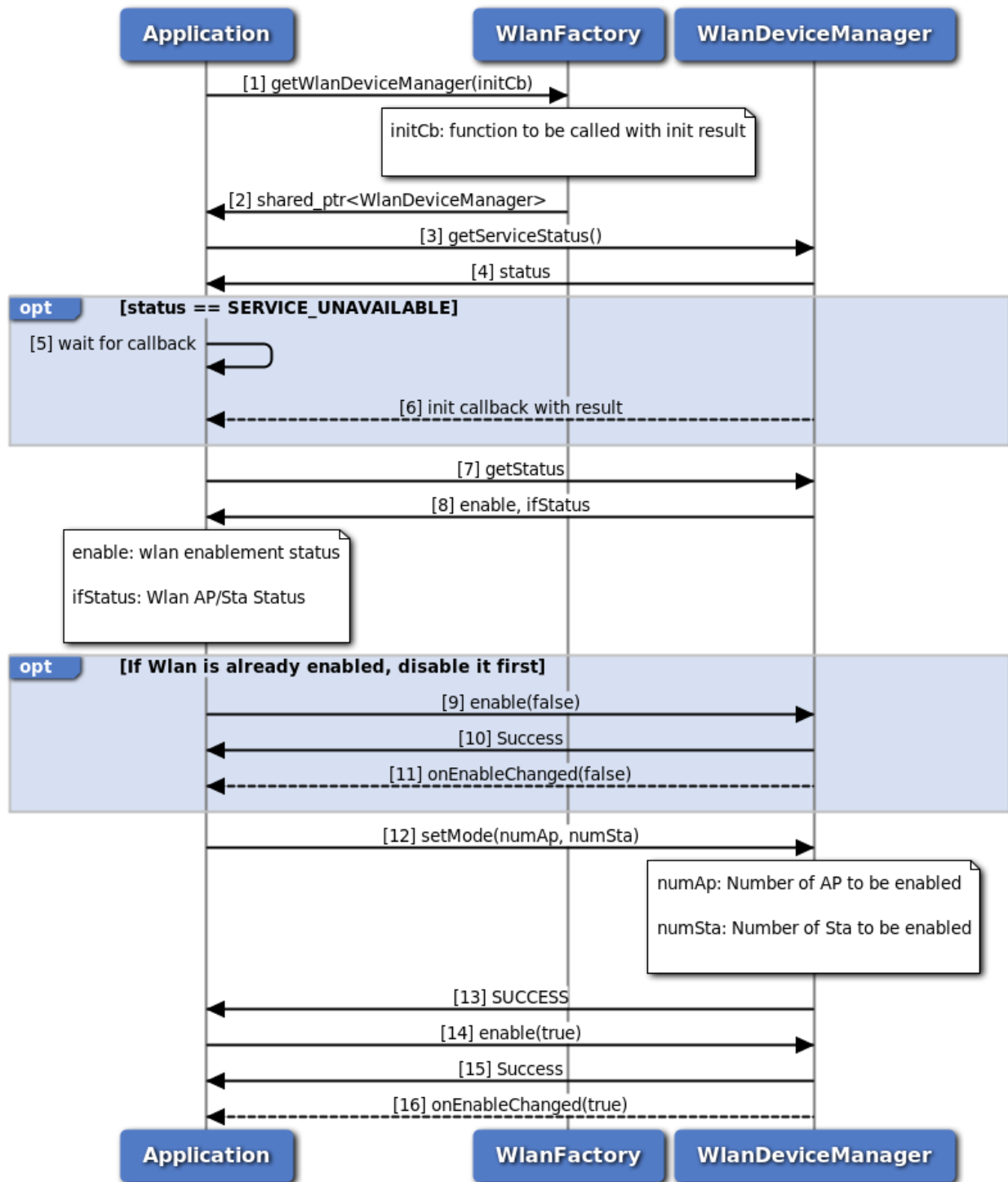

Figure 3-144 Modify WLAN Configuration Call Flow

1. Application requests IWlanDeviceManager object from WLAN factory.
2. WLAN factory returns a shared pointer to the IWlanDeviceManger object to the application.



3. Application can use `IWlanDeviceManager::getServiceStatus` to determine if the system is ready.
4. The application receives the status, i.e., `SERVICE_AVAILABLE` or `SERVICE_UNAVAILABLE`, to indicate if the subsystem is ready.
  - (a) If the subsystem is not ready, the application can wait for the callback provided in Step 1 for subsystem initialization status.
  - (b) Application provided callback is invoked with subsystem status (`SERVICE_AVAILABLE`/`SERVICE_FAILED`).
5. When the subsystem is ready, application calls `IWlanDeviceManager::getStatus` to get WLAN enablement status.
6. Application receives WLAN enablement status.
  - (a) If WLAN is enabled, application calls `IWlanDeviceManager::enable(false)` to disable WLAN.
  - (b) Application receives WLAN disablement response and waits for WLAN status indication.
  - (c) Application receives WLAN status indication `IWlanDeviceManager::onEnableChanged(false)` to indicate WLAN is disabled.
7. Application sets desired configuration using `IWlanDeviceManager::setMode` to set desired number of access points and stations to be enabled.
8. Application receives response.
9. Application calls `IWlanDeviceManager::enable(true)` to enable WLAN.
10. Application receives WLAN enablement response and waits for WLAN status indication.
11. Application receives WLAN status indication `IWlanDeviceManager::onEnableChanged(true)` to indicate WLAN is enabled.

### 3.13.2 Call flow to modify WLAN station configuration

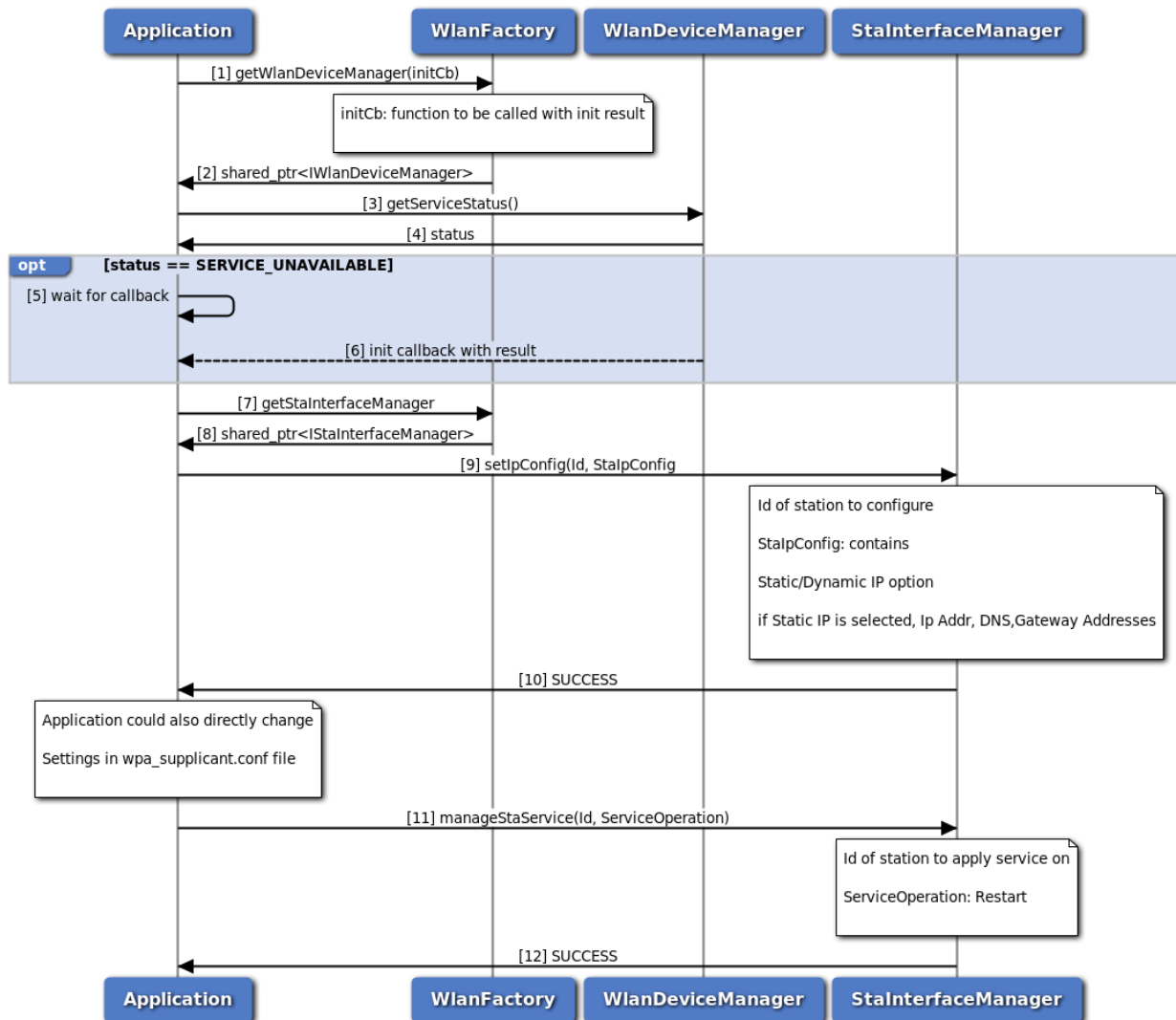

**Figure 3-145 Modify WLAN Station Configuration Call Flow**

1. Application requests IWlanDeviceManager object from WLAN factory.
2. WLAN factory returns shared pointer to IWlanDeviceManager to the application.
3. Application can use IWlanDeviceManager::getServiceStatus to determine if the system is ready.
4. The application receives the Status i.e. either SERVICE\_AVAILABLE or SERVICE\_UNAVAILABLE to indicate whether sub-system is ready or not.
  - (a) If subsystem is not ready, then the application could wait for callback provided in step 1 for subsystem initialization status.
  - (b) Application provided callback is invoked with subsystem status (SERVICE\_AVAILABLE/SERVICE\_FAILED).
5. On Readiness, requests IStaInterfaceManager object from WLAN factory.

6. WLAN factory returns shared pointer to IStaInterfaceManager to the application.
7. Application calls IStaInterfaceManager::setIpConfig to set desired IP configurations.
8. Application receives response set IP configuration.
9. Application calls IStaInterfaceManager::managerStaService to restart wpa\_supplicant daemon.
10. Application receives response to restart wpa\_supplicant daemon and station configuration shall be active at this stage.

### 3.13.3 Call flow to Modify WLAN Access Point Configuration

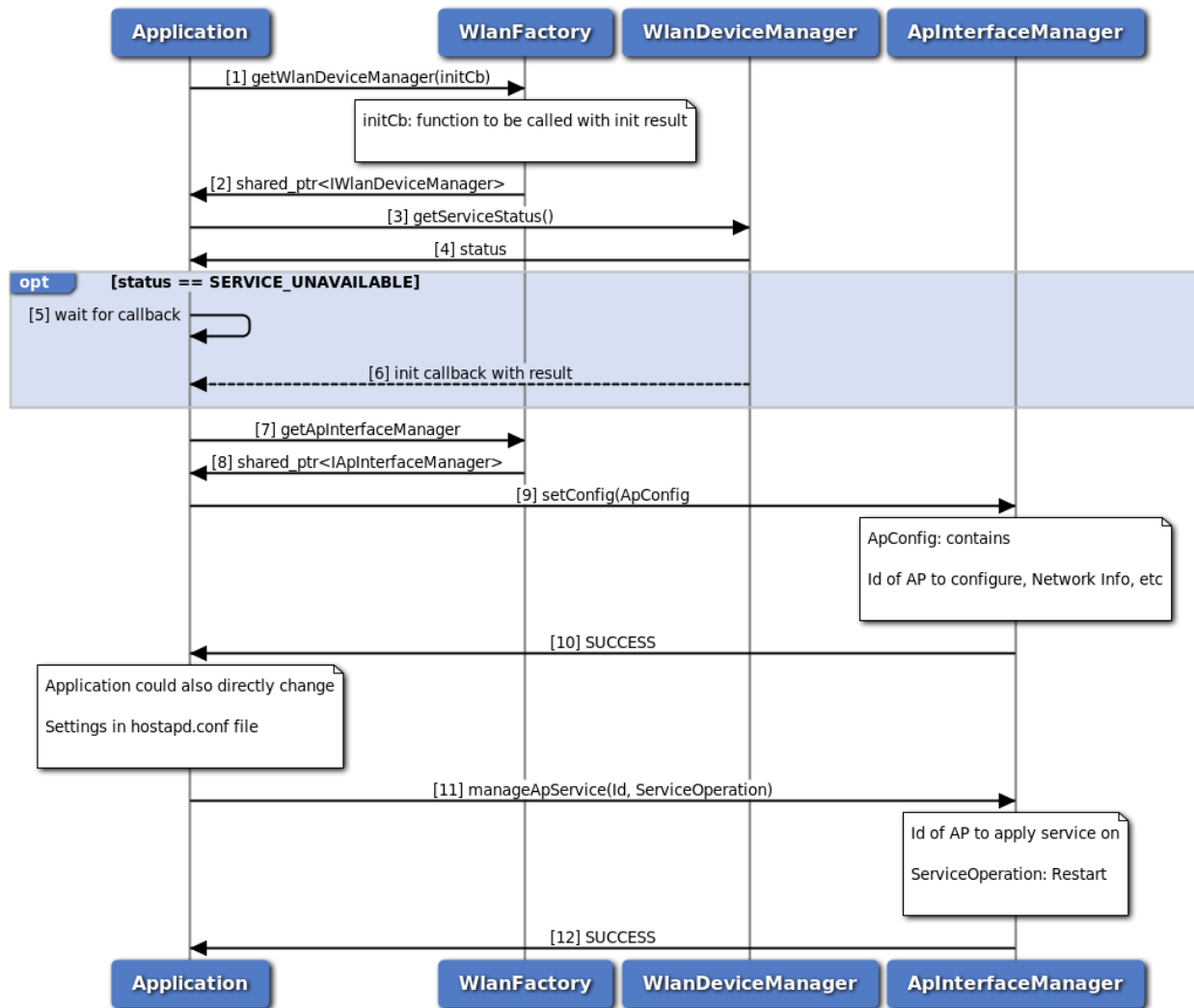

Figure 3-146 Modify WLAN Access Point Configuration Call Flow

1. Application requests IWlanDeviceManager object from WLAN factory.
2. WLAN factory returns shared pointer to IWlanDeviceManager to the application.
3. Application can use IWlanDeviceManager::getServiceStatus to determine if the system is ready.

4. The application receives the Status i.e. either SERVICE\_AVAILABLE or SERVICE\_UNAVAILABLE to indicate whether sub-system is ready or not.
  - (a) If subsystem is not ready, then the application could wait for callback provided in step 1 for subsystem initialization status.
  - (b) Application provided callback is invoked with subsystem status (SERVICE\_AVAILABLE/SERVICE\_FAILED).
5. On Readiness, requests IApInterfaceManager object from WLAN factory.
6. WLAN factory returns shared pointer to IApInterfaceManager to the application.
7. Application calls IApInterfaceManager::setConfig to set desired IP configurations.
8. Application receives response set configuration.
9. Application calls IApInterfaceManager::managerApService to restart hostapd daemon.
10. Application receives response to restart hostapd daemon and access point configuration shall be active at this stage.

## 3.14 Diagnostics

### 3.14.1 Call flow to collect logs using file method

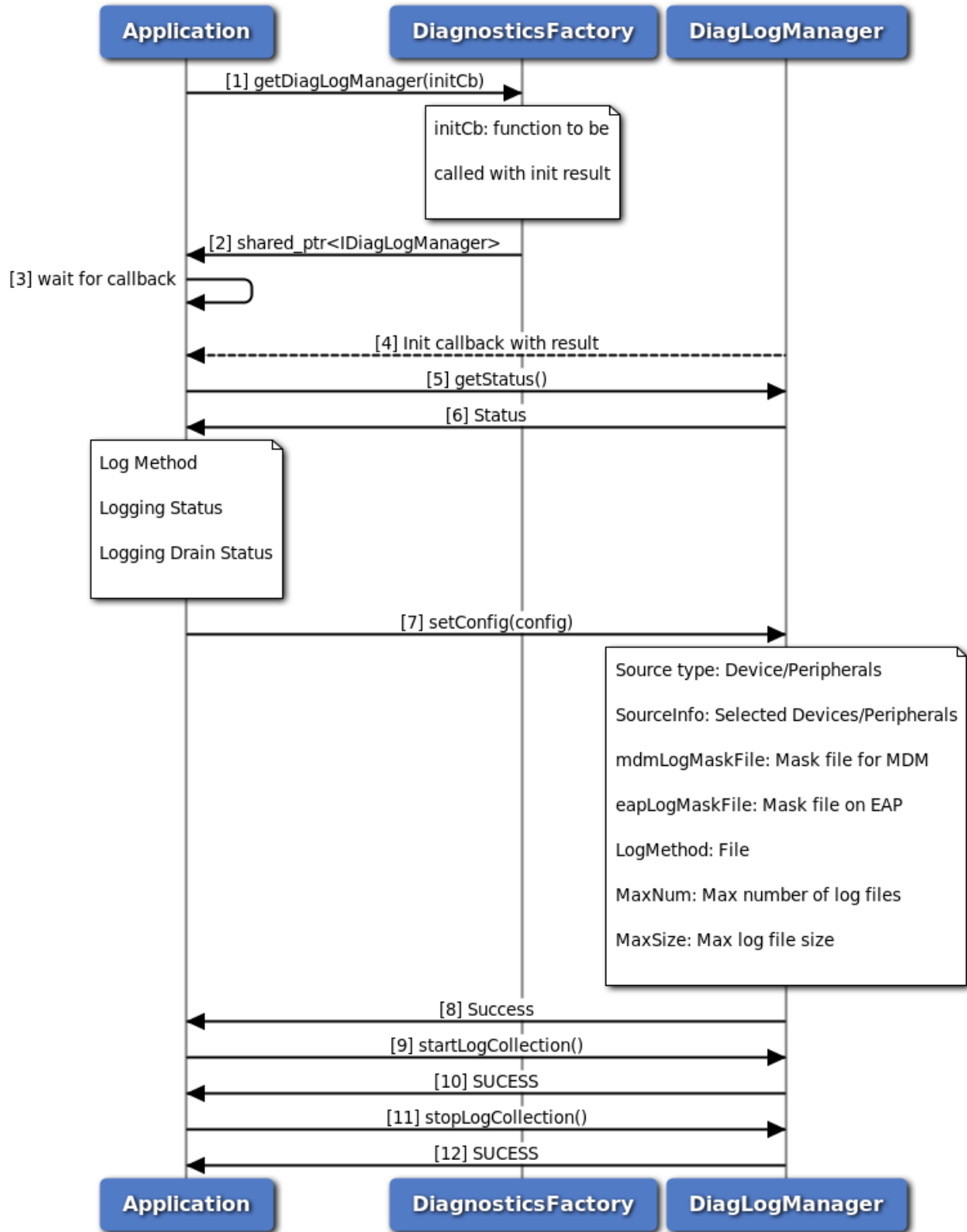

Figure 3-147 Log Collection Using File Method Call Flow

1. Application requests IDiagLogManager object from Diagnostics factory.
2. Diagnostics factory returns a shared pointer to the Diagnostics factory object to the application.
3. Application shall wait for init callback
4. Application shall ensure subsystem is ready before proceeding
5. Application can use IDiagLogManager::getStatus to determine the current system status.
6. Application can check returned status to ensure diag logging is not already in progress.
7. Application can call IDiagLogManager::setConfig to set desired configurations.
8. Application must ensure the return status is Success.
9. Application can call IDiagLogManager::startLogCollection to start logging.
10. Application must ensure the return status is Success.
11. Application can IDiagLogManager::stopLogCollection to stop logging.
12. Application must ensure the return status is Success.

### 3.14.2 Call flow to collect logs using callback method

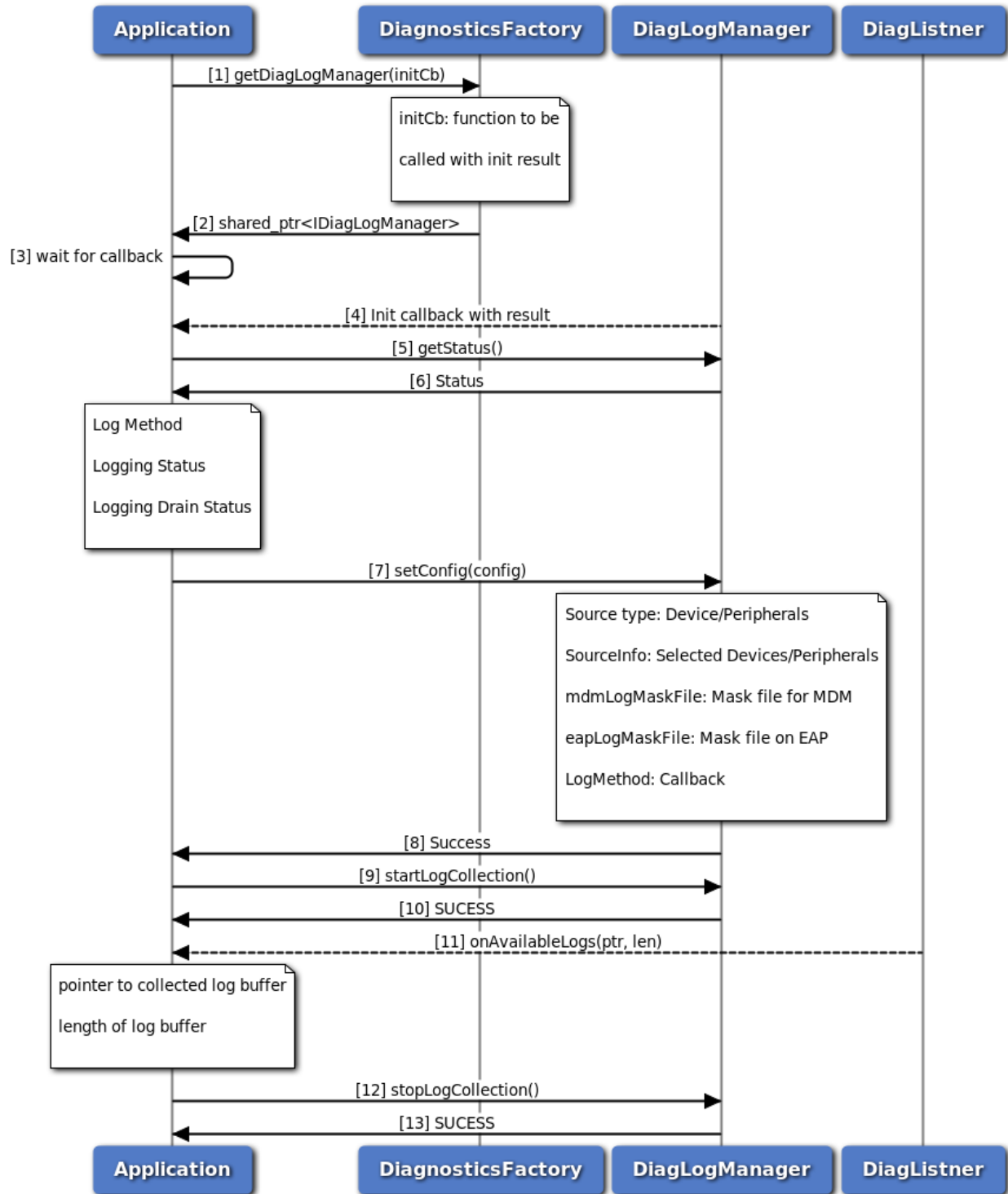

Figure 3-148 Log Collection Using Callback Method Call Flow

1. Application requests IDiagLogManager object from Diagnostics factory.
2. Diagnostics factory returns a shared pointer to the Diagnostics factory object to the application.

3. Application shall wait for init callback
4. Application shall ensure subsystem is ready before proceeding
5. Application can use IDiagLogManager::getStatus to determine the current system status.
6. Application can check returned status to ensure diag logging is not already in progress.
7. Application can call IDiagLogManager::setConfig to set desired configurations.
8. Application must ensure the return status is Success.
9. Application can call IDiagLogManager::startLogCollection to start logging.
10. Application must ensure the return status is Success.
11. TelSDK will invoke callback provided by the application whenever new log entry is available.
12. Application can IDiagLogManager::stopLogCollection to stop logging.
13. Application must ensure the return status is Success.



# 4 Interfaces

---

## 4.1 Telematics SDK APIs

- [Telephony](#)
- [Location](#)
- [Common](#)
- [Audio](#)
- [Thermal](#)
- [Power](#)
- [Modem Configuration](#)
- [Sensor](#)
- [Platform](#)
- [Security Management](#)
- [Wlan](#)
- [Diagnostics Services](#)
- [Cellular Data](#)
- [Cellular V2X](#)

## 4.2 Telephony

- [Phone](#)
- [Call](#)
- [eCall](#)
- [SMS](#)
- [SIM Card Services](#)
- [Cell Broadcast](#)
- [IMS Settings](#)
- [Multi SIM](#)
- [Subscription Management](#)
- [Network Selection](#)
- [Serving System](#)
- [Remote SIM Provisioning](#)
- [Remote SIM](#)
- [Supplementary Services](#)

This section contains APIs related to Telephony.

## 4.3 Phone

This section contains APIs related to Phone, Signal Strength and interfaces to register global listeners to event notifications.

### 4.3.1 Data Structure Documentation

#### 4.3.1.1 class `telux::tel::GsmCellIdentity`

`GsmCellIdentity` class provides methods to get mobile country code, mobile network code, location area code, cell identity, absolute RF channel number and base station identity code.

##### Public member functions

- `GsmCellIdentity` (`std::string mcc`, `std::string mnc`, `int lac`, `int cid`, `int arfcn`, `int bsic`)
- `const int getMcc ()`
- `const int getMnc ()`
- `const std::string getMobileCountryCode ()`
- `const std::string getMobileNetworkCode ()`
- `const int getLac ()`
- `const int getIdentity ()`
- `const int getArfcn ()`
- `const int getBaseStationIdentityCode ()`

##### 4.3.1.1.1 Constructors and Destructors

4.3.1.1.1.1 `telux::tel::GsmCellIdentity::GsmCellIdentity ( std::string mcc, std::string mnc, int lac, int cid, int arfcn, int bsic )`

##### 4.3.1.1.2 Member Function Documentation

4.3.1.1.2.1 `const int telux::tel::GsmCellIdentity::getMcc ( )`

Get the Mobile Country Code.

##### Returns

Mcc value.

##### Deprecated

Use `getMobileCountryCode()` API instead

**4.3.1.1.2.2 const int telux::tel::GsmCellIdentity::getMnc ( )**

Get the Mobile Network Code.

**Returns**

Mnc value.

**Deprecated**

Use [getMobileNetworkCode\(\)](#) API instead

**4.3.1.1.2.3 const std::string telux::tel::GsmCellIdentity::getMobileCountryCode ( )**

Get the Mobile Country Code.

**Returns**

Mcc value.

**4.3.1.1.2.4 const std::string telux::tel::GsmCellIdentity::getMobileNetworkCode ( )**

Get the Mobile Network Code.

**Returns**

Mnc value.

**4.3.1.1.2.5 const int telux::tel::GsmCellIdentity::getLac ( )**

Get the location area code.

**Returns**

Location area code.

**4.3.1.1.2.6 const int telux::tel::GsmCellIdentity::getIdentity ( )**

Get the cell identity.

**Returns**

Cell identity.

#### 4.3.1.1.2.7 `const int telux::tel::GsmCellIdentity::getArfcn ( )`

Get the absolute RF channel number.

##### Returns

Absolute RF channel number.

#### 4.3.1.1.2.8 `const int telux::tel::GsmCellIdentity::getBaseStationIdentityCode ( )`

Get the base station identity code.

##### Returns

Base station identity code.

### 4.3.1.2 `class telux::tel::CdmaCellIdentity`

[CdmaCellIdentity](#) class provides methods to get the network identifier, system identifier, base station identifier, longitude and latitude.

##### Deprecated

As of version 1.53.0 this API is no longer supported.

##### Public member functions

- [CdmaCellIdentity](#) (int networkId, int systemId, int baseStationId, int longitude, int latitude)
- `const int getNid ( )`
- `const int getSid ( )`
- `const int getBaseStationId ( )`
- `const int getLongitude ( )`
- `const int getLatitude ( )`

#### 4.3.1.2.1 Constructors and Destructors

4.3.1.2.1.1 `telux::tel::CdmaCellIdentity::CdmaCellIdentity ( int networkId, int systemId, int baseStationId, int longitude, int latitude )`

#### 4.3.1.2.2 Member Function Documentation

**4.3.1.2.2.1 const int telux::tel::CdmaCellIdentity::getNid ( )**

Get the network identifier.

**Returns**

Network identifier.

**4.3.1.2.2.2 const int telux::tel::CdmaCellIdentity::getSid ( )**

Get the system identifier.

**Returns**

System identifier.

**4.3.1.2.2.3 const int telux::tel::CdmaCellIdentity::getBaseStationId ( )**

Get the base station identifier.

**Returns**

Base station identifier.

**4.3.1.2.2.4 const int telux::tel::CdmaCellIdentity::getLongitude ( )**

Get the longitude.

**Returns**

Longitude.

**4.3.1.2.2.5 const int telux::tel::CdmaCellIdentity::getLatitude ( )**

Get the latitude.

**Returns**

Latitude.

**4.3.1.3 class telux::tel::LteCellIdentity**

[LteCellIdentity](#) class provides methods to get the mobile country code, mobile network code, cell identity, physical cell identifier, tracking area code and absolute Rf channel number.

## Public member functions

- [LteCellIdentity](#) (std::string mcc, std::string mnc, int ci, int pci, int tac, int earfcn)
- const int [getMcc](#) ()
- const int [getMnc](#) ()
- const std::string [getMobileCountryCode](#) ()
- const std::string [getMobileNetworkCode](#) ()
- const int [getIdentity](#) ()
- const int [getPhysicalCellId](#) ()
- const int [getTrackingAreaCode](#) ()
- const int [getEarfcn](#) ()

### 4.3.1.3.1 Constructors and Destructors

4.3.1.3.1.1 `telux::tel::LteCellIdentity::LteCellIdentity ( std::string mcc, std::string mnc, int ci, int pci, int tac, int earfcn )`

### 4.3.1.3.2 Member Function Documentation

4.3.1.3.2.1 `const int telux::tel::LteCellIdentity::getMcc ( )`

Get the Mobile Country Code.

#### Returns

Mcc value.

#### Deprecated

Use [getMobileCountryCode\(\)](#) API instead

4.3.1.3.2.2 `const int telux::tel::LteCellIdentity::getMnc ( )`

Get the Mobile Network Code.

#### Returns

Mnc value.

#### Deprecated

Use [getMobileNetworkCode\(\)](#) API instead

**4.3.1.3.2.3 const std::string telux::tel::LteCellIdentity::getMobileCountryCode ( )**

Get the Mobile Country Code.

**Returns**

Mcc value.

**4.3.1.3.2.4 const std::string telux::tel::LteCellIdentity::getMobileNetworkCode ( )**

Get the Mobile Network Code.

**Returns**

Mnc value.

**4.3.1.3.2.5 const int telux::tel::LteCellIdentity::getIdentity ( )**

Get the cell identity.

**Returns**

Cell identity.

**4.3.1.3.2.6 const int telux::tel::LteCellIdentity::getPhysicalCellId ( )**

Get the physical cell identifier.

**Returns**

Physical cell identifier.

**4.3.1.3.2.7 const int telux::tel::LteCellIdentity::getTrackingAreaCode ( )**

Get the tracking area code.

**Returns**

Tracking area code.

**4.3.1.3.2.8 const int telux::tel::LteCellIdentity::getEarfcn ( )**

Get the absolute RF channel number.

**Returns**

Absolute RF channel number.



### 4.3.1.4 class telux::tel::WcdmaCellIdentity

[WcdmaCellIdentity](#) class provides methods to get the mobile country code, mobile network code, location area code, cell identifier, primary scrambling code and absolute RF channel number.

#### Public member functions

- [WcdmaCellIdentity](#) (std::string mcc, std::string mnc, int lac, int cid, int psc, int uarfcn)
- const int [getMcc](#) ()
- const int [getMnc](#) ()
- const std::string [getMobileCountryCode](#) ()
- const std::string [getMobileNetworkCode](#) ()
- const int [getLac](#) ()
- const int [getIdentity](#) ()
- const int [getPrimaryScramblingCode](#) ()
- const int [getUarfcn](#) ()

#### 4.3.1.4.1 Constructors and Destructors

4.3.1.4.1.1 `telux::tel::WcdmaCellIdentity::WcdmaCellIdentity ( std::string mcc, std::string mnc, int lac, int cid, int psc, int uarfcn )`

#### 4.3.1.4.2 Member Function Documentation

4.3.1.4.2.1 `const int telux::tel::WcdmaCellIdentity::getMcc ( )`

Get the Mobile Country Code.

#### Returns

Mcc value.

#### Deprecated

Use [getMobileCountryCode\(\)](#) API instead

**4.3.1.4.2.2 const int telux::tel::WcdmaCellIdentity::getMnc ( )**

Get the Mobile Network Code.

**Returns**

Mnc value.

**Deprecated**

Use [getMobileNetworkCode\(\)](#) API instead

**4.3.1.4.2.3 const std::string telux::tel::WcdmaCellIdentity::getMobileCountryCode ( )**

Get the Mobile Country Code.

**Returns**

Mcc value.

**4.3.1.4.2.4 const std::string telux::tel::WcdmaCellIdentity::getMobileNetworkCode ( )**

Get the Mobile Network Code.

**Returns**

Mnc value.

**4.3.1.4.2.5 const int telux::tel::WcdmaCellIdentity::getLac ( )**

Get the location area code.

**Returns**

Location area code.

**4.3.1.4.2.6 const int telux::tel::WcdmaCellIdentity::getIdentity ( )**

Get the cell identity.

**Returns**

Cell identity.

#### 4.3.1.4.2.7 `const int telux::tel::WcdmaCellIdentity::getPrimaryScramblingCode ( )`

Get the primary scrambling code.

##### Returns

Primary scrambling code.

#### 4.3.1.4.2.8 `const int telux::tel::WcdmaCellIdentity::getUarfcn ( )`

Get the absolute RF channel number.

##### Returns

Absolute RF channel number.

### 4.3.1.5 `class telux::tel::TdscdmaCellIdentity`

`TdscdmaCellIdentity` class provides methods to get the mobile country code, mobile network code, location area code, cell identity and cell parameters identifier.

##### Deprecated

As of version 1.53.0 this API is no longer supported.

##### Public member functions

- `TdscdmaCellIdentity` (`std::string mcc`, `std::string mnc`, `int lac`, `int cid`, `int cpid`)
- `const int getMcc ( )`
- `const int getMnc ( )`
- `const std::string getMobileCountryCode ( )`
- `const std::string getMobileNetworkCode ( )`
- `const int getLac ( )`
- `const int getIdentity ( )`
- `const int getParametersId ( )`

#### 4.3.1.5.1 Constructors and Destructors

##### 4.3.1.5.1.1 `telux::tel::TdscdmaCellIdentity::TdscdmaCellIdentity ( std::string mcc, std::string mnc, int lac, int cid, int cpid )`

#### 4.3.1.5.2 Member Function Documentation

##### 4.3.1.5.2.1 `const int telux::tel::TdscdmaCellIdentity::getMcc ( )`

Get the Mobile Country Code.

#### Returns

Mcc value.

#### Deprecated

Use [getMobileCountryCode\(\)](#) API instead

##### 4.3.1.5.2.2 `const int telux::tel::TdscdmaCellIdentity::getMnc ( )`

Get the Mobile Network Code.

#### Returns

Mnc value.

#### Deprecated

Use [getMobileNetworkCode\(\)](#) API instead

##### 4.3.1.5.2.3 `const std::string telux::tel::TdscdmaCellIdentity::getMobileCountryCode ( )`

Get the Mobile Country Code.

#### Returns

Mcc value.

##### 4.3.1.5.2.4 `const std::string telux::tel::TdscdmaCellIdentity::getMobileNetworkCode ( )`

Get the Mobile Network Code.

#### Returns

Mnc value.

##### 4.3.1.5.2.5 `const int telux::tel::TdscdmaCellIdentity::getLac ( )`

Get the location area code

#### Returns

Location area code.

#### 4.3.1.5.2.6 `const int telux::tel::TdscdmaCellIdentity::getIdentity ( )`

Get the cell identity.

##### Returns

Cell identity.

#### 4.3.1.5.2.7 `const int telux::tel::TdscdmaCellIdentity::getParametersId ( )`

Get the cell parameters identifier.

##### Returns

Cell parameters identifier.

### 4.3.1.6 `class telux::tel::Nr5gCellIdentity`

`Nr5gCellIdentity` class provides methods to get the mobile country code, mobile network code, cell identity, physical cell identifier, tracking area code and absolute RF channel number information of the Serving cell

#### Public member functions

- `Nr5gCellIdentity` (`std::string mcc`, `std::string mnc`, `uint64_t ci`, `uint32_t pci`, `int32_t tac`, `int32_t arfcn`)
- `const std::string getMobileCountryCode ( )`
- `const std::string getMobileNetworkCode ( )`
- `const uint64_t getIdentity ( )`
- `const uint32_t getPhysicalCellId ( )`
- `const int32_t getTrackingAreaCode ( )`
- `const int32_t getArfcn ( )`

#### 4.3.1.6.1 Constructors and Destructors

4.3.1.6.1.1 `telux::tel::Nr5gCellIdentity::Nr5gCellIdentity ( std::string mcc, std::string mnc, uint64_t ci, uint32_t pci, int32_t tac, int32_t arfcn )`

#### 4.3.1.6.2 Member Function Documentation

4.3.1.6.2.1 `const std::string telux::tel::Nr5gCellIdentity::getMobileCountryCode ( )`

Get the Mobile Country Code.

##### Returns

Mcc value.

#### 4.3.1.6.2.2 `const std::string telux::tel::Nr5gCellIdentity::getMobileNetworkCode ( )`

Get the Mobile Network Code.

##### Returns

Mnc value.

#### 4.3.1.6.2.3 `const uint64_t telux::tel::Nr5gCellIdentity::getIdentity ( )`

Get the cell identity.

##### Returns

Cell identity.

#### 4.3.1.6.2.4 `const uint32_t telux::tel::Nr5gCellIdentity::getPhysicalCellId ( )`

Get the physical cell identifier.

##### Returns

Physical cell identifier.

#### 4.3.1.6.2.5 `const int32_t telux::tel::Nr5gCellIdentity::getTrackingAreaCode ( )`

Get the tracking area code.

##### Returns

Tracking area code.

#### 4.3.1.6.2.6 `const int32_t telux::tel::Nr5gCellIdentity::getArfcn ( )`

Get the absolute RF channel number.

##### Returns

Absolute RF channel number. '-1' denotes that the value is unknown.

### 4.3.1.7 `class telux::tel::CellInfo`

[CellInfo](#) class provides cell info type and checks whether the current cell is registered or not.

##### Public member functions

- virtual [CellType](#) `getType ( )`
- virtual bool `isRegistered ( )`

## Protected Attributes

- [CellType](#) `type_`
- `int` [registered\\_](#)

### 4.3.1.7.1 Member Function Documentation

#### 4.3.1.7.1.1 `virtual CellType telux::tel::CellInfo::getType ( ) [virtual]`

Get the cell type.

#### Returns

`CellType`.

#### 4.3.1.7.1.2 `virtual bool telux::tel::CellInfo::isRegistered ( ) [virtual]`

Checks whether the current cell is registered or not.

#### Returns

If true cell is registered or vice-versa.

### 4.3.1.7.2 Field Documentation

#### 4.3.1.7.2.1 `CellType telux::tel::CellInfo::type_ [protected]`

#### 4.3.1.7.2.2 `int telux::tel::CellInfo::registered_ [protected]`

### 4.3.1.8 class `telux::tel::GsmCellInfo`

[GsmCellInfo](#) class provides methods to get cell type, cell registration status, cell identity and signal strength information.

#### Public member functions

- [GsmCellInfo](#) (`int` `registered`, [GsmCellIdentity](#) `id`, [GsmSignalStrengthInfo](#) `ssInfo`)
- [GsmCellIdentity](#) `getCellIdentity ( )`
- [GsmSignalStrengthInfo](#) `getSignalStrengthInfo ( )`

#### Additional Inherited Members

### 4.3.1.8.1 Constructors and Destructors

#### 4.3.1.8.1.1 `telux::tel::GsmCellInfo::GsmCellInfo ( int registered, GsmCellIdentity id, GsmSignal↔StrengthInfo ssInfo )`

[GsmCellInfo](#) constructor.

**Parameters**

in	<i>registered</i>	- Registration status of the cell.
in	<i>id</i>	- GSM cell identity.
in	<i>ssInfo</i>	- GSM cell signal strength.

**4.3.1.8.2 Member Function Documentation****4.3.1.8.2.1 `GsmCellIdentity telux::tel::GsmCellInfo::getCellIdentity ( )`**

Get GSM cell identity information.

**Returns**

[GsmCellIdentity](#).

**4.3.1.8.2.2 `GsmSignalStrengthInfo telux::tel::GsmCellInfo::getSignalStrengthInfo ( )`**

Get GSM cell signal strength information.

**Returns**

[GsmSignalStrengthInfo](#).

**4.3.1.9 class `telux::tel::CdmaCellInfo`**

[CdmaCellInfo](#) class provides methods to get cell type, cell registration status, cell identity and signal strength information.

**Deprecated**

As of version 1.53.0 this API is no longer supported.

**Public member functions**

- [CdmaCellInfo](#) (int registered, [CdmaCellIdentity](#) id, [CdmaSignalStrengthInfo](#) ssInfo)
- [CdmaCellIdentity](#) `getCellIdentity ()`
- [CdmaSignalStrengthInfo](#) `getSignalStrengthInfo ()`

**Additional Inherited Members****4.3.1.9.1 Constructors and Destructors**



#### 4.3.1.9.1.1 `telux::tel::CdmaCellInfo::CdmaCellInfo ( int registered, CdmaCellIdentity id, CdmaSignalStrengthInfo ssInfo )`

[CdmaCellInfo](#) constructor

##### Parameters

in	<i>registered</i>	- Registration status of the cell.
in	<i>id</i>	- CDMA cell identity.
in	<i>ssInfo</i>	- CDMA cell signal strength.

#### 4.3.1.9.2 Member Function Documentation

##### 4.3.1.9.2.1 `CdmaCellIdentity telux::tel::CdmaCellInfo::getCellIdentity ( )`

Get CDMA cell identity information.

##### Returns

[CdmaCellIdentity](#).

##### 4.3.1.9.2.2 `CdmaSignalStrengthInfo telux::tel::CdmaCellInfo::getSignalStrengthInfo ( )`

Get CDMA cell signal strength information.

##### Returns

[CdmaSignalStrengthInfo](#).

#### 4.3.1.10 class `telux::tel::LteCellInfo`

[LteCellInfo](#) class provides methods to get cell type, cell registration status, cell identity and signal strength information.

##### Public member functions

- [LteCellInfo](#) (int *registered*, [LteCellIdentity](#) *id*, [LteSignalStrengthInfo](#) *ssInfo*)
- [LteCellIdentity](#) `getCellIdentity ( )`
- [LteSignalStrengthInfo](#) `getSignalStrengthInfo ( )`

##### Additional Inherited Members

#### 4.3.1.10.1 Constructors and Destructors

##### 4.3.1.10.1.1 `telux::tel::LteCellInfo::LteCellInfo ( int registered, LteCellIdentity id, LteSignalStrengthInfo ssInfo )`

[LteCellInfo](#) constructor.

**Parameters**

in	<i>registered</i>	- Registration status of the cell.
in	<i>id</i>	- LTE cell identity class.
in	<i>ssInfo</i>	- LTE cell signal strength.

**4.3.1.10.2 Member Function Documentation****4.3.1.10.2.1 LteCellIdentity telux::tel::LteCellInfo::getCellIdentity ( )**

Get LTE cell identity information.

**Returns**

[LteCellIdentity](#).

**4.3.1.10.2.2 LteSignalStrengthInfo telux::tel::LteCellInfo::getSignalStrengthInfo ( )**

Get LTE cell signal strength information.

**Returns**

[LteSignalStrengthInfo](#).

**4.3.1.11 class telux::tel::WcdmaCellInfo**

[WcdmaCellInfo](#) class provides methods to get cell type, cell registration status, cell identity and signal strength information.

**Public member functions**

- [WcdmaCellInfo](#) (int *registered*, [WcdmaCellIdentity](#) *id*, [WcdmaSignalStrengthInfo](#) *ssInfo*)
- [WcdmaCellIdentity](#) *getCellIdentity* ()
- [WcdmaSignalStrengthInfo](#) *getSignalStrengthInfo* ()

**Additional Inherited Members****4.3.1.11.1 Constructors and Destructors****4.3.1.11.1.1 telux::tel::WcdmaCellInfo::WcdmaCellInfo ( int *registered*, [WcdmaCellIdentity](#) *id*, [WcdmaSignalStrengthInfo](#) *ssInfo* )**

[WcdmaCellInfo](#) constructor.

**Parameters**

in	<i>registered</i>	- Registration status of the cell.
in	<i>id</i>	- WCDMA cell identity.

in	<i>ssInfo</i>	- WCDMA cell signal strength.
----	---------------	-------------------------------

#### 4.3.1.11.2 Member Function Documentation

##### 4.3.1.11.2.1 WcdmaCellIdentity telux::tel::WcdmaCellInfo::getCellIdentity ( )

Get WCDMA cell identity information.

#### Returns

[WcdmaCellIdentity](#).

##### 4.3.1.11.2.2 WcdmaSignalStrengthInfo telux::tel::WcdmaCellInfo::getSignalStrengthInfo ( )

Get WCDMA cell signal strength information.

#### Returns

[WcdmaSignalStrengthInfo](#).

#### 4.3.1.12 class telux::tel::TdscdmaCellInfo

[TdscdmaCellInfo](#) class provides methods to get cell type, cell registration status, cell identity and signal strength information.

#### Deprecated

As of version 1.53.0 this API is no longer supported.

#### Public member functions

- [TdscdmaCellInfo](#) (int registered, [TdscdmaCellIdentity](#) id, [TdscdmaSignalStrengthInfo](#) ssInfo)
- [TdscdmaCellIdentity](#) getCellIdentity ()
- [TdscdmaSignalStrengthInfo](#) getSignalStrengthInfo ()

#### Additional Inherited Members

##### 4.3.1.12.1 Constructors and Destructors

###### 4.3.1.12.1.1 telux::tel::TdscdmaCellInfo::TdscdmaCellInfo ( int *registered*, [TdscdmaCellIdentity](#) *id*, [TdscdmaSignalStrengthInfo](#) *ssInfo* )

[TdscdmaCellInfo](#) constructor.

**Parameters**

in	<i>registered</i>	- Registration status of the cell
in	<i>id</i>	- TDSCDMA cell identity.
in	<i>ssInfo</i>	- TDSCDMA cell signal strength.

**4.3.1.12.2 Member Function Documentation****4.3.1.12.2.1 TdscdmaCellIdentity telux::tel::TdscdmaCellInfo::getCellIdentity ( )**

Get TDSCDMA cell identity information.

**Returns**

[TdscdmaCellIdentity](#).

**4.3.1.12.2.2 TdscdmaSignalStrengthInfo telux::tel::TdscdmaCellInfo::getSignalStrengthInfo ( )**

Get TDSCDMA cell signal strength information.

**Returns**

[TdscdmaSignalStrengthInfo](#).

**4.3.1.13 class telux::tel::Nr5gCellInfo**

[Nr5gCellInfo](#) class provides methods to get cell type, cell registration status, cell identity and signal strength information corresponding to the Serving cell.

**Public member functions**

- [Nr5gCellInfo](#) (int *registered*, [Nr5gCellIdentity](#) *id*, [Nr5gSignalStrengthInfo](#) *ssInfo*)
- [Nr5gCellIdentity](#) [getCellIdentity](#) ()
- [Nr5gSignalStrengthInfo](#) [getSignalStrengthInfo](#) ()

**Additional Inherited Members****4.3.1.13.1 Constructors and Destructors****4.3.1.13.1.1 telux::tel::Nr5gCellInfo::Nr5gCellInfo ( int *registered*, [Nr5gCellIdentity](#) *id*, [Nr5gSignalStrengthInfo](#) *ssInfo* )****4.3.1.13.2 Member Function Documentation**

**4.3.1.13.2.1 Nr5gCellIdentity telux::tel::Nr5gCellInfo::getCellIdentity ( )**

Get NR5G cell identity information.

**Returns**

[Nr5gCellIdentity](#).

**4.3.1.13.2.2 Nr5gSignalStrengthInfo telux::tel::Nr5gCellInfo::getSignalStrengthInfo ( )**

Get NR5G cell signal strength information.

**Returns**

[Nr5gSignalStrengthInfo](#).

**4.3.1.14 struct telux::tel::ECallMsdOptionals**

Represents the availability of some optional parameters in MSD as per European eCall MSD standard EN 15722.

**Data fields**

Type	Field	Description
<a href="#">ECall</a> ↔ <a href="#">OptionalData</a> ↔ <a href="#">Type</a>	<a href="#">optionalData</a> ↔ Type	Type of optional data
bool	<a href="#">optionalData</a> ↔ Present	Availability of Optional data: true - Present or false - Absent
bool	<a href="#">recentVehicle</a> ↔ <a href="#">LocationN1</a> ↔ Present	Availability of Recent Vehicle Location N1 data: true - Present or false - Absent. In MSD version-3 (as per EN 15722:2020), as <a href="#">recentVehicleLocationN1</a> is mandatory, this should be set to true by client
bool	<a href="#">recentVehicle</a> ↔ <a href="#">LocationN2</a> ↔ Present	Availability of Recent Vehicle Location N2 data: true - Present or false - Absent. In MSD version-3 (as per EN 15722:2020), as <a href="#">recentVehicleLocationN2</a> is mandatory, this should be set to true by client
bool	<a href="#">numberOf</a> ↔ <a href="#">Passengers</a> ↔ Present	Availability of number of seat belts fastened data: true - Present or false - Absent

Type	Field	Description
------	-------	-------------

#### 4.3.1.15 struct telux::tel::ECallMsdControlBits

Represents [ECallMsdControlBits](#) structure as per European eCall MSD standard. i.e. EN 15722.

##### Data fields

Type	Field	Description
bool	automatic↔ Activation	auto / manual activation
bool	testCall	test / emergency call
bool	positionCan↔ BeTrusted	false if coincidence < 95% of reported pos within +/- 150m
<a href="#">ECallVehicle↔ Type</a>	vehicleType: 5	Represents a vehicle class as per EN 15722

#### 4.3.1.16 struct telux::tel::ECallVehicleIdentificationNumber

Represents [VehicleIdentificationNumber](#) structure as per European eCall MSD standard. i.e. EN 15722. Vehicle Identification Number confirming ISO3779.

##### Data fields

Type	Field	Description
string	isowmi	World Manufacturer Index (WMI)
string	isovds	Vehicle Type Descriptor (VDS)
string	isovis↔ Modelyear	Model year from Vehicle Identifier Section (VIS)
string	isovisSeqPlant	Plant code + sequential number from VIS

#### 4.3.1.17 struct telux::tel::ECallVehiclePropulsionStorageType

Represents [VehiclePropulsionStorageType](#) structure as per European eCall MSD standard. i.e. EN 15722. Vehicle Propulsion type (energy storage): True- Present, False - Absent

##### Data fields

Type	Field	Description
bool	gasolineTank↔ Present	Represents the presence of Gasoline Tank in the vehicle.
bool	dieselTank↔ Present	Represents the presence of Diesel Tank in the vehicle
bool	compressed↔ NaturalGas	Represents the presence of CNG in the vehicle
bool	liquid↔ PropaneGas	Represents the presence of Liquid Propane Gas in the vehicle
bool	electric↔ EnergyStorage	Represents the presence of Electronic Storage in the vehicle

Type	Field	Description
bool	hydrogen↔ Storage	Represents the presence of Hydrogen Storage in the vehicle
bool	otherStorage	Represents the presence of Other types of storage in the vehicle

#### 4.3.1.18 struct telux::tel::ECallVehicleLocation

Represents VehicleLocation structure as per European eCall MSD standard. i.e. EN 15722.

##### Data fields

Type	Field	Description
int32_t	position↔ Latitude	latitude in milliarcsec, range is (-2147483648 to 2147483647)
int32_t	position↔ Longitude	longitude in milliarcsec, range is (-2147483648 to 2147483647)

#### 4.3.1.19 struct telux::tel::ECallVehicleLocationDelta

Represents VehicleLocationDelta structure as per European eCall MSD standard. i.e. EN 15722. Delta with respect to Current Vehicle location.

##### Data fields

Type	Field	Description
int16_t	latitudeDelta	( 1 Unit = 100 milliarcseconds, range: -512 to 511)
int16_t	longitudeDelta	( 1 Unit = 100 milliarcseconds, range: -512 to 511)

#### 4.3.1.20 struct telux::tel::ECallOptionalPdu

Optional information for the emergency rescue service.

##### Data fields

Type	Field	Description
ECallDefault↔ Options	eCallDefault↔ Options	Optional information. This field is unused and deprecated. Use the other fields below, instead.
string	oid	Relative object identifier(OID) as per European standard i.e. EN 15722
vector< uint8↔ _t >	data	Optional additional data content.

#### 4.3.1.21 struct telux::tel::ECallMsdata

Data structure to hold all details required to construct an MSD. Supports MSD version-2(as per EN 15722:2015) and MSD version-3(as per EN 15722:2020)

**Data fields**

Type	Field	Description
<a href="#">ECallMsd↔ Optionals</a>	optionals	Indicates presence of optionals in ECall MSD
uint8_t	message↔ Identifier	Starts with 1 for each new eCall and to be incremented with every retransmission
<a href="#">ECallMsd↔ ControlBits</a>	control	<a href="#">ECallMsdControlBits</a> structure as per European standard i.e. EN 15722
<a href="#">ECallVehicle↔ Identification↔ Number</a>	vehicle↔ Identification↔ Number	VIN (vehicle identification number) according to ISO3779
<a href="#">ECallVehicle↔ Propulsion↔ StorageType</a>	vehicle↔ Propulsion↔ Storage	VehiclePropulsionStorageType structure as per European standard i.e. EN 15722
uint32_t	timestamp	Seconds elapsed since midnight 01.01.1970 UTC
<a href="#">ECallVehicle↔ Location</a>	vehicleLocation	VehicleLocation structure as per European standard. i.e. EN 15722
uint8_t	vehicle↔ Direction	Direction of travel in 2 degrees steps from magnetic north
<a href="#">ECallVehicle↔ LocationDelta</a>	recentVehicle↔ LocationN1	Change in latitude and longitude compared to the last MSD transmission. Optional field for MSD version-2
<a href="#">ECallVehicle↔ LocationDelta</a>	recentVehicle↔ LocationN2	Change in latitude and longitude compared to the last but one MSD transmission. Optional field for MSD version-2
uint8_t	numberOf↔ Passengers	Number of occupants in the vehicle. Optional field for MSD version-2 and version-3
<a href="#">ECall↔ OptionalPdu</a>	optionalPdu	Optional information for the emergency rescue service (103 bytes, ASN.1 encoded); may also point to an address, where this information is locatedOptional information for the emergency rescue service
uint8_t	msdVersion	MSD format version that is being used

**4.3.1.22 struct telux::tel::ECallModelInfo**

Represents eCall operating mode information

**Data fields**

Type	Field	Description
<a href="#">ECallMode</a>	mode	Represents eCall operating mode
<a href="#">ECallMode↔ Reason</a>	reason	Represents eCall operating mode change reason

**4.3.1.23 struct telux::tel::ECallHlapTimerStatus**

Represents status of various eCall High Level Application Protocol(HLAP) timers that are maintained by UE state machine. This does not retrieve status of timers maintained by the PSAP. The timers are represented according to EN 16062:2015 standard.



**Data fields**

Type	Field	Description
HlapTimer↔ Status	t2	T2 Timer status
HlapTimer↔ Status	t5	T5 Timer status
HlapTimer↔ Status	t6	T6 Timer status
HlapTimer↔ Status	t7	T7 Timer status
HlapTimer↔ Status	t9	T9 Timer status
HlapTimer↔ Status	t10	T10 Timer status

**4.3.1.24 struct telux::tel::ECallHlapTimerEvents**

Represents events that changes the status of various eCall High Level Application Protocol(HLAP) timers that are maintained by UE state machine. This does not retrieve events of timers maintained by the PSAP. The timers are represented according to EN 16062:2015 standard.

**Data fields**

Type	Field	Description
HlapTimer↔ Event	t2	T2 Timer event
HlapTimer↔ Event	t5	T5 Timer event
HlapTimer↔ Event	t6	T6 Timer event
HlapTimer↔ Event	t7	T7 Timer event
HlapTimer↔ Event	t9	T9 Timer event
HlapTimer↔ Event	t10	T10 Timer event

Type	Field	Description
------	-------	-------------

#### 4.3.1.25 struct telux::tel::CustomSipHeader

Represents custom SIP headers for content type and accept info for a PSAP. This provides clients the ability to transfer custom SIP headers with the SIP INVITE that is sent as part of call connect on TPS eCall over IMS. The value corresponding to these data fields should be recognised by a PSAP otherwise no acknowledgement would be received by device.

##### Data fields

Type	Field	Description
string	contentType	Type of data being transmitted and should be filled as per RFC 8147 i.e MSD. Max Length 128 bytes
string	acceptInfo	SIP Accept header. Max length 128 bytes

#### 4.3.1.26 struct telux::tel::EcallConfig

Represents various configuration parameters related to automotive emergency call

##### Data fields

Type	Field	Description
<a href="#">EcallConfig</a> ↔ <a href="#">Validity</a>	config↔ ValidityMask	Indicates the valid configuration parameters in the structure. A bit set to 1 denotes that the corresponding configuration parameter is valid
bool	muteRxAudio	
<a href="#">ECallNumType</a>	numType	
string	overriddenNum	
bool	useCannedMsd	
uint32_t	gnssUpdate↔ Interval	
uint32_t	t2Timer	
uint32_t	t7Timer	
uint32_t	t9Timer	
uint8_t	msdVersion	

#### 4.3.1.27 class telux::tel::IPhone

This class allows getting system information and registering for system events. Each Phone instance is associated with a single SIM. So on a dual SIM device you would have 2 Phone instances.

##### Public member functions

- virtual [telux::common::Status](#) [getPhoneId](#) (int &phoneId)=0
- virtual [RadioState](#) [getRadioState](#) ()=0
- virtual [telux::common::Status](#) [requestVoiceRadioTechnology](#) ([VoiceRadioTechResponseCb](#) callback)=0

- virtual `ServiceState getServiceState ()=0`
- virtual `telux::common::Status requestVoiceServiceState (std::weak_ptr< IVoiceServiceStateCallback > callback)=0`
- virtual `telux::common::Status setRadioPower (bool enable, std::shared_ptr< telux::common::ICommandResponseCallback > callback=nullptr)=0`
- virtual `telux::common::Status requestCellInfo (CellInfoCallback callback)=0`
- virtual `telux::common::Status setCellInfoListRate (uint32_t timeInterval, common::ResponseCallback callback)=0`
- virtual `telux::common::Status requestSignalStrength (std::shared_ptr< ISignalStrengthCallback > callback=nullptr)=0`
- virtual `telux::common::Status setECallOperatingMode (ECallMode eCallMode, telux::common::ResponseCallback callback)=0`
- virtual `telux::common::Status requestECallOperatingMode (ECallGetOperatingModeCallback callback)=0`
- virtual `telux::common::Status requestOperatorName (OperatorNameCallback callback)=0`
- virtual `telux::common::Status configureSignalStrength (std::vector< SignalStrengthConfig > signalStrengthConfig, telux::common::ResponseCallback callback=nullptr)=0`
- virtual `~IPhone ()`

#### 4.3.1.27.1 Constructors and Destructors

4.3.1.27.1.1 virtual `telux::tel::IPhone::~~IPhone ( ) [virtual]`

#### 4.3.1.27.2 Member Function Documentation

4.3.1.27.2.1 virtual `telux::common::Status telux::tel::IPhone::getPhoneId ( int & phoneId ) [pure virtual]`

Get the Phone ID corresponding to phone.

##### Parameters

out	<i>phoneId</i>	Unique identifier for the phone
-----	----------------	---------------------------------

##### Returns

Status of `getPhoneId` i.e. success or suitable error code.

**4.3.1.27.2.2 virtual RadioState telux::tel::IPhone::getRadioState ( ) [pure virtual]**

Get Radio state of device.

**Returns**

[RadioState](#)

**Deprecated**

Use [IPhoneManager::requestOperatingMode\(\)](#) API instead

**4.3.1.27.2.3 virtual telux::common::Status telux::tel::IPhone::requestVoiceRadioTechnology ( VoiceRadioTechResponseCb callback ) [pure virtual]**

Request for Radio technology type (3GPP/3GPP2) used for voice.

**Parameters**

in	<i>callback</i>	callback pointer to get the response of radio power request <a href="#">telux::tel::VoiceRadioTechResponseCb</a>
----	-----------------	---

**Returns**

Status of requestVoiceRadioTechnology i.e. success or suitable error code [telux::common::Status](#).

**Deprecated**

Use [requestVoiceServiceState\(\)](#) API to get [VoiceServiceInfo](#) which has API to get radio technology i.e. [VoiceServiceInfo::getRadioTechnology\(\)](#)

**4.3.1.27.2.4 virtual ServiceState telux::tel::IPhone::getServiceState ( ) [pure virtual]**

Get service state of the phone.

**Returns**

[ServiceState](#)

**Deprecated**

Use [requestVoiceServiceState\(\)](#) API

**4.3.1.27.2.5 virtual telux::common::Status telux::tel::IPhone::requestVoiceServiceState ( std::weak\_ptr< IVoiceServiceStateCallback > callback ) [pure virtual]**

Request for voice service state to get the information of phone serving states

**Parameters**

in	<i>callback</i>	callback pointer to get the response of voice service state <a href="#">telux::tel::IVoiceServiceStateCallback</a> .
----	-----------------	---

**Returns**

Status of requestVoiceServiceState i.e. success or suitable error code [telux::common::Status](#).

**4.3.1.27.2.6** `virtual telux::common::Status telux::tel::IPhone::setRadioPower ( bool enable, std↔  
::shared_ptr< telux::common::ICommandResponseCallback > callback = nullptr )  
[pure virtual]`

Set the radio power on or off.

On platforms with Access control enabled, Caller needs to have TELUX\_TEL\_PHONE\_MGMT permission to invoke this API successfully.

**Parameters**

in	<i>enable</i>	Flag that determines whether to turn radio on or off
in	<i>callback</i>	Optional callback pointer to get the response of set radio power request

**Returns**

Status of setRadioPower i.e. success or suitable error code.

**Deprecated**

Use [IPhoneManager::setOperatingMode\(\)](#) API instead

**4.3.1.27.2.7** `virtual telux::common::Status telux::tel::IPhone::requestCellInfo ( CellInfoCallback  
callback ) [pure virtual]`

Get the cell information about current serving cell and neighboring cells.

On platforms with Access control enabled, Caller needs to have TELUX\_TEL\_PRIVATE\_INFO\_READ permission to invoke this API successfully.

**Parameters**

in	<i>callback</i>	Callback to get the response of cell info request <a href="#">telux::tel::CellInfoCallback</a>
----	-----------------	---

**Returns**

Status of requestCellInfo i.e. success or suitable error

#### 4.3.1.27.2.8 virtual telux::common::Status telux::tel::iPhone::setCellInfoListRate ( uint32\_t *timeInterval*, common::ResponseCallback *callback* ) [pure virtual]

Set the minimum time in milliseconds between when the cell info list should be received.

On platforms with Access control enabled, Caller needs to have TELUX\_TEL\_PHONE\_CONFIG permission to invoke this API successfully.

##### Parameters

in	<i>timeInterval</i>	Value of 0 means receive cell info list when any info changes. Value of INT_MAX means never receive cell info list even on change. Default value is 0
in	<i>callback</i>	Callback to get the response for set cell info list rate.

##### Returns

Status of setCellInfoListRate i.e. success or suitable error

#### 4.3.1.27.2.9 virtual telux::common::Status telux::tel::iPhone::requestSignalStrength ( std::shared\_ptr<ISignalStrengthCallback > *callback = nullptr* ) [pure virtual]

Get current signal strength of the associated network.

##### Parameters

in	<i>callback</i>	Optional callback pointer to get the response of signal strength request
----	-----------------	--

##### Returns

Status of requestSignalStrength i.e. success or suitable error code.

#### 4.3.1.27.2.10 virtual telux::common::Status telux::tel::iPhone::setECallOperatingMode ( ECallMode *eCallMode*, telux::common::ResponseCallback *callback* ) [pure virtual]

Sets the eCall operating mode

On platforms with Access control enabled, Caller needs to have TELUX\_TEL\_ECALL\_CONFIG permission to invoke this API successfully.

##### Parameters

in	<i>eCallMode</i>	- <a href="#">ECallMode</a>
in	<i>callback</i>	- Callback function to get the response for set eCall operating mode request.

##### Returns

Status of setECallOperatingMode i.e. success or suitable error

#### 4.3.1.27.2.11 **virtual telux::common::Status telux::tel::IPhone::requestECallOperatingMode ( ECallGetOperatingModeCallback *callback* ) [pure virtual]**

Get the eCall operating mode

##### Parameters

in	<i>callback</i>	- Callback function to get the response of eCall operating mode request
----	-----------------	---

##### Returns

Status of requestECallOperatingMode i.e. success or suitable error

#### 4.3.1.27.2.12 **virtual telux::common::Status telux::tel::IPhone::requestOperatorName ( Operator↔ NameCallback *callback* ) [pure virtual]**

Get current registered operator name. This API returns PLMN name if available. If not then it returns the SPN configured in the SIM card.

On platforms with Access control enabled, Caller needs to have TELUX\_TEL\_PRIVATE\_INFO\_READ permission to invoke this API successfully.

##### Parameters

in	<i>callback</i>	- Callback function to get the response of operator name request
----	-----------------	--

##### Returns

Status of requestOperatorName i.e. success or suitable error

#### 4.3.1.27.2.13 **virtual telux::common::Status telux::tel::IPhone::configureSignalStrength ( std::vector< SignalStrengthConfig > *signalStrengthConfig*, telux::common::ResponseCallback *callback = nullptr* ) [pure virtual]**

Configures [SignalStrength](#) notification.

This API configures [SignalStrength](#) notifications based on the RAT(s) delta or threshold provided for [SignalStrength](#).

- Delta (unsigned 2 bytes): The value should be a non-zero positive integer, in units of 0.1dBm. For example to set a delta of 10dBm, the delta value should be 100. A notification is sent when the difference between the current value and the last reported value crosses the specified delta.

-Threshold (signed 4 bytes): For example to set threshold at -95dBm and -80dBm, the threshold list values are -950, -800, since the the list values are in units of 0.1 dBm. A notification is sent when the current signal strength crosses one of the registered thresholds.

The threshold range list is as follows. See [SignalStrength.hpp](#) for more details.

- GSM\_RSSI : -113 to -51 (in dBm)

- WCDMA\_RSSI: -113 to -51 (in dBm)
- LTE\_RSSI : -113 to -51 (in dBm)
- LTE\_SNR : -200 to 300 (in dB)
- LTE\_RSRQ : -20 to -3 (in dB)
- LTE\_RSRP : -140 to -44 (in dBm)
- NR5G\_SNR : -200 to 300 (in dB)
- NR5G\_RSRP : -140 to -44 (in dBm)
- NR5G\_RSRQ : -20 to -3 (in dB)

This configuration is a global setting. The signal strength setting does not persist through device reboot and needs to be configured again. Default signal strength values are set after a device reboot.

On platforms with access control enabled, the caller needs to have the TELUX\_TEL\_PHONE\_MGMT permission to successfully invoke this API.

#### Parameters

in	<i>signalStrengthConfig</i>	Signal strength configuration.
in	<i>callback</i>	Callback function to get the <a href="#">SignalStrength</a> configuration response.

#### Returns

Status of `configureSignalStrength`, i.e., success or the suitable error code.

#### Note

Eval: This is a new API and is being evaluated. It is subject to change and could break backwards compatibility.

#### 4.3.1.28 class `telux::tel::ISignalStrengthCallback`

Interface for Signal strength callback object. Client needs to implement this interface to get single shot responses for commands like get signal strength.

The methods in callback can be invoked from multiple different threads. The implementation should be thread safe.

#### Public member functions

- virtual void `signalStrengthResponse` (std::shared\_ptr< [SignalStrength](#) > signalStrength, [telux::common::ErrorCode](#) error)
- virtual `~ISignalStrengthCallback` ()



### 4.3.1.28.1 Constructors and Destructors

4.3.1.28.1.1 `virtual telux::tel::ISignalStrengthCallback::~ISignalStrengthCallback ( ) [virtual]`

### 4.3.1.28.2 Member Function Documentation

4.3.1.28.2.1 `virtual void telux::tel::ISignalStrengthCallback::signalStrengthResponse ( std::shared_ptr< SignalStrength > signalStrength, telux::common::ErrorCode error ) [virtual]`

This function is called with the response to requestSignalStrength API.

#### Parameters

in	<i>signalStrength</i>	Pointer to signal strength object
in	<i>error</i>	Return code for whether the operation succeeded or failed <a href="#">SUCCESS</a> <a href="#">telux::common::ErrorCode::RADIO_NOT_AVAILABLE</a>

### 4.3.1.29 class telux::tel::IVoiceServiceStateCallback

Interface for voice service state callback object. Client needs to implement this interface to get single shot responses for commands like request voice radio technology.

The methods in callback can be invoked from multiple different threads. The implementation should be thread safe.

#### Public member functions

- `virtual void voiceServiceStateResponse (const std::shared_ptr< VoiceServiceInfo > &serviceInfo, telux::common::ErrorCode error)`
- `virtual ~IVoiceServiceStateCallback ()`

### 4.3.1.29.1 Constructors and Destructors

4.3.1.29.1.1 `virtual telux::tel::IVoiceServiceStateCallback::~IVoiceServiceStateCallback ( ) [virtual]`

### 4.3.1.29.2 Member Function Documentation

4.3.1.29.2.1 `virtual void telux::tel::IVoiceServiceStateCallback::voiceServiceStateResponse ( const std::shared_ptr< VoiceServiceInfo > & serviceInfo, telux::common::ErrorCode error ) [virtual]`

This function is called with the response to requestVoiceServiceState API.

**Parameters**

in	<i>serviceInfo</i>	Pointer to voice service info object <a href="#">telux::tel::VoiceServiceInfo</a>
in	<i>error</i>	Return code for whether the operation succeeded or failed <ul style="list-style-type: none"> <li><a href="#">telux::common::ErrorCode::SUCCESS</a></li> <li><a href="#">telux::common::ErrorCode::RADIO_NOT_AVAILABLE</a></li> <li><a href="#">telux::common::ErrorCode::GENERIC_FAILURE</a></li> </ul>

**4.3.1.30 struct telux::tel::SimRatCapability**

Structure contains slotID and RAT capabilities corresponding to slot.

**Data fields**

Type	Field	Description
int	slotId	
<a href="#">RAT</a> ↔ <a href="#">Capabilities</a> ↔ <a href="#">Mask</a>	capabilities	

**4.3.1.31 struct telux::tel::CellularCapabilityInfo**

Structure contains information about device capability.

**Data fields**

Type	Field	Description
<a href="#">VoiceService</a> ↔ <a href="#">Technologies</a> ↔ <a href="#">Mask</a>	voiceService↔ Techs	Indicates voice support capabilities
int	simCount	The maximum number of SIMs that can be supported simultaneously
int	maxActiveSims	The maximum number of SIMs that can be simultaneously active. If this number is less than numberOfSims, it implies that any combination of the SIMs can be active and the remaining can be in standby.
vector< <a href="#">Sim</a> ↔ <a href="#">RatCapability</a> >	simRat↔ Capabilities	A Sim inserted in a slot allows for certain rat capabilities. And the UE's HW allows for certain rat capabilities. This field lists the intersection of capabilities allowed by the Sim and the HW. The capabilities are indexed based on slotId.
vector< <a href="#">DeviceRat</a> ↔ <a href="#">Capability</a> >	deviceRat↔ Capability	This field lists the Rat capabilities supported by the HW on a given Sim slot. The capabilities are indexed based on slotId.

### 4.3.1.32 struct telux::tel::SignalStrengthThreshold

Defines the [SignalStrength](#) threshold parameters.

#### Data fields

Type	Field	Description
int32_t	lowerRange↔ Threshold	Lower threshold for the selected radio technology.
int32_t	upperRange↔ Threshold	Upper threshold for the selected radio technology.

### 4.3.1.33 struct telux::tel::SignalStrengthConfig

Defines the [SignalStrength](#) notification configuration parameters and their corresponding values.

#### Data fields

Type	Field	Description
<a href="#">Signal↔ Strength↔ ConfigType</a>	configType	Signal strength configuration type.
<a href="#">RadioSignal↔ StrengthType</a>	ratSigType	Radio signal strength type.
union <a href="#">Signal↔ StrengthConfig</a>	__unnamed_↔ _	Signal strength data.

### 4.3.1.34 class telux::tel::PhoneFactory

[PhoneFactory](#) is the central factory to create all Telephony SDK Classes and services.

#### Public member functions

- virtual std::shared\_ptr< [IPhoneManager](#) > [getPhoneManager](#) (telux::common::InitResponseCb callback=nullptr)=0
- virtual std::shared\_ptr< [ISmsManager](#) > [getSmsManager](#) (int phoneId=DEFAULT\_PHONE\_ID, telux::common::InitResponseCb callback=nullptr)=0
- virtual std::shared\_ptr< [ICallManager](#) > [getCallManager](#) (telux::common::InitResponseCb callback=nullptr)=0
- virtual std::shared\_ptr< [ICardManager](#) > [getCardManager](#) (telux::common::InitResponseCb callback=nullptr)=0
- virtual std::shared\_ptr< [ISapCardManager](#) > [getSapCardManager](#) (int slotId=DEFAULT\_SLOT\_ID, telux::common::InitResponseCb callback=nullptr)=0
- virtual std::shared\_ptr< [ISubscriptionManager](#) > [getSubscriptionManager](#) (telux::common::InitResponseCb callback=nullptr)=0
- virtual std::shared\_ptr< [IServingSystemManager](#) > [getServingSystemManager](#) (int

- slotId=DEFAULT\_SLOT\_ID, [telux::common::InitResponseCb](#) callback=nullptr)=0
- virtual std::shared\_ptr< [INetworkSelectionManager](#) > [getNetworkSelectionManager](#) (int slotId=DEFAULT\_SLOT\_ID, [telux::common::InitResponseCb](#) callback=nullptr)=0
- virtual std::shared\_ptr< [IRemoteSimManager](#) > [getRemoteSimManager](#) (int slotId=DEFAULT\_SLOT\_ID, [telux::common::InitResponseCb](#) callback=nullptr)=0
- virtual std::shared\_ptr< [IMultiSimManager](#) > [getMultiSimManager](#) ([telux::common::InitResponseCb](#) callback=nullptr)=0
- virtual std::shared\_ptr< [ICellBroadcastManager](#) > [getCellBroadcastManager](#) (SlotId slotId=DEFAULT\_SLOT\_ID, [telux::common::InitResponseCb](#) callback=nullptr)=0
- virtual std::shared\_ptr< [ISimProfileManager](#) > [getSimProfileManager](#) ([telux::common::InitResponseCb](#) callback=nullptr)=0
- virtual std::shared\_ptr< [IimsSettingsManager](#) > [getImsSettingsManager](#) ([telux::common::InitResponseCb](#) callback=nullptr)=0
- virtual std::shared\_ptr< [IEcallManager](#) > [getEcallManager](#) ([telux::common::InitResponseCb](#) callback=nullptr)=0
- virtual std::shared\_ptr< [IHttpTransactionManager](#) > [getHttpTransactionManager](#) ([telux::common::InitResponseCb](#) callback=nullptr)=0
- virtual std::shared\_ptr< [IimsServingSystemManager](#) > [getImsServingSystemManager](#) (SlotId slotId, [telux::common::InitResponseCb](#) callback=nullptr)=0
- virtual std::shared\_ptr< [ISuppServicesManager](#) > [getSuppServicesManager](#) (SlotId slotId=DEFAULT\_SLOT\_ID, [telux::common::InitResponseCb](#) callback=nullptr)=0

**Static Public Member Functions**

- static [PhoneFactory](#) & [getInstance](#) ()

**4.3.1.34.1 Member Function Documentation**

**4.3.1.34.1.1 static [PhoneFactory](#)& [telux::tel::PhoneFactory::getInstance](#) ( ) [static]**

Get Phone Factory instance.

**4.3.1.34.1.2 virtual std::shared\_ptr<[IPhoneManager](#)> [telux::tel::PhoneFactory::getPhoneManager](#) ( [telux::common::InitResponseCb](#) *callback = nullptr* ) [pure virtual]**

Get Phone Manager instance. Phone Manager is the main entry point into the telephony subsystem.

**Parameters**

in	<i>callback</i>	Optional callback pointer to get response of Phone Manager initialization. It will be invoked when initialization is either succeeded or failed. In case of failure response, the provided Phone Manager object will no more be a valid object.
----	-----------------	---

**Returns**

Pointer of [IPhoneManager](#) object.

**4.3.1.34.1.3** `virtual std::shared_ptr<ISmsManager> telux::tel::PhoneFactory::getSmsManager ( int phoneId = DEFAULT_PHONE_ID, telux::common::InitResponseCb callback = nullptr ) [pure virtual]`

Get SMS Manager instance for Phone ID. SMSManager used to send and receive SMS messages.

**Parameters**

in	<i>phoneId</i>	Unique identifier for the phone
in	<i>callback</i>	Optional callback pointer to get response of SMS Manager initialization. It will be invoked when initialization is either succeeded or failed. In case of failure response, the provided SMS Manager object will no more be a valid object.

**Returns**

Pointer of [ISmsManager](#) object or nullptr in case of failure.

**4.3.1.34.1.4** `virtual std::shared_ptr<ICallManager> telux::tel::PhoneFactory::getCallManager ( telux::common::InitResponseCb callback = nullptr ) [pure virtual]`

Get Call Manager instance to determine state of active calls and perform other functions like dial, conference, swap call.

**Parameters**

in	<i>callback</i>	Optional callback pointer to get response of CallManager initialization. It will be invoked when initialization is either succeeded or failed. In case of failure response, the provided Call Manager object will no more be a valid object.
----	-----------------	--

**Returns**

Pointer of [ICallManager](#) object or nullptr in case of failure.

**4.3.1.34.1.5** `virtual std::shared_ptr<ICardManager> telux::tel::PhoneFactory::getCardManager ( telux::common::InitResponseCb callback = nullptr ) [pure virtual]`

Get Card Manager instance to handle services such as transmitting APDU, SIM IO and more.

**Parameters**

in	<i>callback</i>	Optional callback pointer to get response of Card Manager initialization. It will be invoked when initialization is either succeeded or failed. In case of failure response, the provided Phone Manager object will no more be a valid object.
----	-----------------	--

**Returns**

Pointer of [ICardManager](#) object.

**4.3.1.34.1.6** `virtual std::shared_ptr<ISapCardManager> telux::tel::PhoneFactory::getSapCardManager ( int slotId = DEFAULT_SLOT_ID, telux::common::InitResponseCb callback = nullptr ) [pure virtual]`

Get Sap Card Manager instance associated with the provided slot id. This object will handle services in SAP mode such as APDU, SIM Power On/Off and SIM reset.

On platforms with access control enabled, caller needs to have TELUX\_TEL\_SAP permission to invoke this API successfully.

**Parameters**

in	<i>slotId</i>	Unique identifier for the SIM slot
in	<i>callback</i>	Optional callback pointer to get the response of the manager initialisation.

**Returns**

Pointer of [ISapCardManager](#) object.

**4.3.1.34.1.7** `virtual std::shared_ptr<ISubscriptionManager> telux::tel::PhoneFactory::getSubscriptionManager ( telux::common::InitResponseCb callback = nullptr ) [pure virtual]`

Get Subscription Manager instance to get device subscription details

**Parameters**

in	<i>callback</i>	Optional callback pointer to get response of Phone Manager initialization. It will be invoked when initialization is either succeeded or failed. In case of failure response, the provided SubscriptionManager object will no more be a valid object.
----	-----------------	---

**Returns**

Pointer of [ISubscriptionManager](#) object.

**4.3.1.34.1.8** `virtual std::shared_ptr<IServingSystemManager> telux::tel::PhoneFactory::getServingSystemManager ( int slotId = DEFAULT_SLOT_ID, telux::common::InitResponseCb callback = nullptr ) [pure virtual]`

Get Serving System Manager instance to get and set preferred network type.

**Parameters**

in	<i>slotId</i>	Unique identifier for the SIM slot
in	<i>callback</i>	Optional callback pointer to get the response of the manager initialisation.

**Returns**

Pointer of [IServingSystemManager](#) object.

**4.3.1.34.1.9** `virtual std::shared_ptr<INetworkSelectionManager> telux::tel::PhoneFactory::getNetworkSelectionManager ( int slotId = DEFAULT_SLOT_ID, telux::common::InitResponseCb callback = nullptr ) [pure virtual]`

Get Network Selection Manager instance to get and set selection mode, get and set preferred networks and scan available networks.

**Parameters**

in	<i>slotId</i>	Unique identifier for the SIM slot
in	<i>callback</i>	Optional callback pointer to get the response of the manager initialisation.

**Returns**

Pointer of [INetworkSelectionManager](#) object.

**4.3.1.34.1.10** `virtual std::shared_ptr<IRemoteSimManager> telux::tel::PhoneFactory::getRemoteSimManager ( int slotId = DEFAULT_SLOT_ID, telux::common::InitResponseCb callback = nullptr ) [pure virtual]`

Get Remote SIM Manager instance to handle services like exchanging APDU, SIM Power On/Off, etc.

On platforms with access control enabled, caller needs to have TELUX\_TEL\_REMOTE\_SIM permission to invoke this API successfully.

**Parameters**

in	<i>slotId</i>	Unique identifier for the SIM slot
in	<i>callback</i>	Optional callback pointer to get response of RemoteSim Manager initialization. It will be invoked when initialization is either succeeded or failed. In case of failure response, the provided Phone Manager object will no more be a valid object.

**Returns**

Pointer of [IRemoteSimManager](#) object.

**4.3.1.34.1.11** `virtual std::shared_ptr<IMultiSimManager> telux::tel::PhoneFactory::getMultiSimManager ( telux::common::InitResponseCb callback = nullptr ) [pure virtual]`

Get Multi SIM Manager instance to handle operations like high capability switch.

#### Parameters

in	<i>callback</i>	Optional callback pointer to get response of MultiSimManager initialization. It will be invoked when initialization is either succeeded or failed. In case of failure response, the provided MultiSimManager object will no more be a valid object.
----	-----------------	---

#### Returns

Pointer of [IMultiSimManager](#) object.

**4.3.1.34.1.12** `virtual std::shared_ptr<ICellBroadcastManager> telux::tel::PhoneFactory::getCellBroadcastManager ( SlotId slotId = DEFAULT_SLOT_ID, telux::common::InitResponseCb callback = nullptr ) [pure virtual]`

Get CellBroadcast Manager instance for Slot ID. CellBroadcast manager used to receive broadcast messages and configure broadcast messages.

#### Parameters

in	<i>slotId</i>	telux::common::SlotId
in	<i>callback</i>	Optional callback pointer to get response of CellBroadcast Manager initialization. It will be invoked when initialization is either succeeded or failed. In case of failure response, the provided Phone Manager object will no more be a valid object.

#### Returns

Pointer of [ICellBroadcastManager](#) object or nullptr in case of failure.

**4.3.1.34.1.13** `virtual std::shared_ptr<ISimProfileManager> telux::tel::PhoneFactory::getSimProfileManager ( telux::common::InitResponseCb callback = nullptr ) [pure virtual]`

Get SimProfileManager. SimProfileManager is a primary interface for remote eUICC(eSIM) provisioning and local profile assistance.

#### Parameters

in	<i>callback</i>	Optional callback pointer to get response of <a href="#">SimProfile Manager</a> initialization. It will be invoked when initialization is either succeeded or failed. In case of failure response, the provided Phone Manager object will no more be a valid object.
----	-----------------	--



**Returns**

Pointer of [ISimProfileManager](#) object or nullptr in case of failure.

**4.3.1.34.1.14** `virtual std::shared_ptr<IImSettingsManager> telux::tel::PhoneFactory::getImSettingsManager ( telux::common::InitResponseCb callback = nullptr ) [pure virtual]`

Get Im Settings Manager instance to handle IMS service enable configuration parameters like enable/disable voIMS.

**Parameters**

in	<i>callback</i>	Optional callback pointer to get the response of the manager initialisation.
----	-----------------	--

**Returns**

Pointer of [IImSettingsManager](#) object.

**4.3.1.34.1.15** `virtual std::shared_ptr<IEcallManager> telux::tel::PhoneFactory::getEcallManager ( telux::common::InitResponseCb callback = nullptr ) [pure virtual]`

**4.3.1.34.1.16** `virtual std::shared_ptr<IHttpTransactionManager> telux::tel::PhoneFactory::getHttpTransactionManager ( telux::common::InitResponseCb callback = nullptr ) [pure virtual]`

Get HttpTransactionManager instance to handle HTTP related requests from the modem for SIM profile update related operations.

**Parameters**

in	<i>callback</i>	Optional callback pointer to get the response of the manager initialisation.
----	-----------------	--

**Returns**

Pointer of [IHttpTransactionManager](#) object or nullptr in case of failure.

**4.3.1.34.1.17** `virtual std::shared_ptr<IImServingSystemManager> telux::tel::PhoneFactory::getImServingSystemManager ( SlotId slotId, telux::common::InitResponseCb callback = nullptr ) [pure virtual]`

Get IMS Serving System Manager instance to query IMS registration status

**Returns**

Pointer of [IImServingSystemManager](#) object or nullptr in case of failure.

**4.3.1.34.1.18** `virtual std::shared_ptr<ISupServicesManager> telux::tel::PhoneFactory::getSup←  
ServicesManager ( SlotId slotId = DEFAULT_SLOT_ID, telux::common::InitResponseCb  
callback = nullptr ) [pure virtual]`

Get Supplementary service manager instance to set/get preference for supplementary services like call waiting, call forwarding etc.

#### Parameters

in	<i>SlotId</i>	telux::common::SlotId
in	<i>callback</i>	Optional callback pointer to get the response of the manager initialisation.

#### Returns

Pointer of [ISupServicesManager](#) object.

### 4.3.1.35 class telux::tel::IPhoneListener

A listener class for monitoring changes in specific telephony states on the device, including service state and signal strength. Override the methods for the state that you wish to receive updates for.

The methods in listener can be invoked from multiple different threads. The implementation should be thread safe.

#### Public member functions

- virtual void [onServiceStateChanged](#) (int phoneId, [ServiceState](#) state)
- virtual void [onSignalStrengthChanged](#) (int phoneId, std::shared\_ptr< [SignalStrength](#) > signalStrength)
- virtual void [onCellInfoListChanged](#) (int phoneId, std::vector< std::shared\_ptr< [CellInfo](#) >> cellInfoList)
- virtual void [onRadioStateChanged](#) (int phoneId, [RadioState](#) radioState)
- virtual void [onVoiceRadioTechnologyChanged](#) (int phoneId, [RadioTechnology](#) radioTech)
- virtual void [onVoiceServiceStateChanged](#) (int phoneId, const std::shared\_ptr< [VoiceServiceInfo](#) > &serviceInfo)
- virtual void [onOperatingModeChanged](#) ([OperatingMode](#) mode)
- virtual void [onECallOperatingModeChange](#) (int phoneId, [telux::tel::ECallModeInfo](#) info)
- virtual [~IPhoneListener](#) ()

#### 4.3.1.35.1 Constructors and Destructors

**4.3.1.35.1.1 virtual telux::tel::IphoneListener::~~IphoneListener ( ) [virtual]****4.3.1.35.2 Member Function Documentation****4.3.1.35.2.1 virtual void telux::tel::IphoneListener::onServiceStateChanged ( int *phoneId*, ServiceState *state* ) [virtual]**

This function is called when device service state changes.

**Parameters**

in	<i>phoneId</i>	Unique id of the phone on which service state changed.
in	<i>state</i>	Service state of the phone <a href="#">ServiceState</a>

**Deprecated**

Use [onVoiceServiceStateChanged\(\)](#) listener

**4.3.1.35.2.2 virtual void telux::tel::IphoneListener::onSignalStrengthChanged ( int *phoneId*, std::shared\_ptr< SignalStrength > *signalStrength* ) [virtual]**

This function is called when network signal strength changes.

**Parameters**

in	<i>phoneId</i>	Unique id of the phone on which signal strength state changed.
in	<i>signalStrength</i>	Pointer to signal strength object

**4.3.1.35.2.3 virtual void telux::tel::IphoneListener::onCellInfoListChanged ( int *phoneId*, std::vector< std::shared\_ptr< CellInfo >> *cellInfoList* ) [virtual]**

This function is called when info pertaining to current or neighboring cells change.

On platforms with Access control enabled, Caller needs to have TELUX\_TEL\_PRIVATE\_INFO\_READ permission to receive this notification.

**Parameters**

in	<i>phoneId</i>	Unique id of the phone on which cell info changed.
in	<i>cellInfoList</i>	vector of shared pointers to cell info object

**4.3.1.35.2.4 virtual void telux::tel::IphoneListener::onRadioStateChanged ( int *phoneId*, RadioState *radioState* ) [virtual]**

This function is called when radio state changes on phone

**Parameters**

in	<i>phoneId</i>	Unique id of the phone on which radio state changed
in	<i>radioState</i>	Radio state of the phone <a href="#">RadioState</a>

**Deprecated**

Use [onOperatingModeChanged\(\)](#) API instead

#### 4.3.1.35.2.5 virtual void telux::tel::IPhoneListener::onVoiceRadioTechnologyChanged ( int *phoneId*, *RadioTechnology radioTech* ) [virtual]

This function is called when the radio technology for voice service changes

**Parameters**

in	<i>phoneId</i>	Unique id of the phone on which radio technology changed
in	<i>radioTech</i>	Radio state of the phone <a href="#">telux::tel::RadioTechnology</a>

**Deprecated**

Use [onVoiceServiceStateChanged\(\)](#) API instead

#### 4.3.1.35.2.6 virtual void telux::tel::IPhoneListener::onVoiceServiceStateChanged ( int *phoneId*, const std::shared\_ptr< VoiceServiceInfo > & *serviceInfo* ) [virtual]

This function is called when the service state for voice service changes

**Parameters**

in	<i>phoneId</i>	Unique id of the phone on which radio technology changed
in	<i>serviceInfo</i>	pointer of voice service state info object <a href="#">telux::tel::VoiceServiceInfo</a>

#### 4.3.1.35.2.7 virtual void telux::tel::IPhoneListener::onOperatingModeChanged ( *OperatingMode mode* ) [virtual]

This function is called when the operating mode changes

**Parameters**

in	<i>mode</i>	Operating mode <a href="#">OperatingMode</a> .
----	-------------	--

#### 4.3.1.35.2.8 virtual void telux::tel::IphoneListener::onECallOperatingModeChange ( int *phoneId*, telux::tel::ECallModeInfo *info* ) [virtual]

This function is called when eCall operating mode changes.

##### Parameters

in	<i>phoneId</i>	- Unique Id of phone for which eCall operating mode changed
in	<i>info</i>	- Indicates eCall operating mode change reason <a href="#">ECallModeInfo</a>

#### 4.3.1.36 class telux::tel::IphoneManager

Phone Manager creates one or more phones based on SIM slot count, it allows clients to register for notification of system events. Clients should check if the subsystem is ready before invoking any of the APIs.

##### Public member functions

- virtual bool [isSubsystemReady](#) ()=0
- virtual std::future< bool > [onSubsystemReady](#) ()=0
- virtual [telux::common::ServiceStatus](#) [getServiceStatus](#) ()=0
- virtual [telux::common::Status](#) [getPhoneIds](#) (std::vector< int > &phoneIds)=0
- virtual int [getPhoneIdFromSlotId](#) (int slotId)=0
- virtual int [getSlotIdFromPhoneId](#) (int phoneId)=0
- virtual std::shared\_ptr< [Iphone](#) > [getPhone](#) (int phoneId=DEFAULT\_PHONE\_ID)=0
- virtual [telux::common::Status](#) [requestCellularCapabilityInfo](#) (std::shared\_ptr< [ICellularCapabilityCallback](#) > callback=nullptr)=0
- virtual [telux::common::Status](#) [requestOperatingMode](#) (std::shared\_ptr< [IOperatingModeCallback](#) > callback=nullptr)=0
- virtual [telux::common::Status](#) [setOperatingMode](#) ([OperatingMode](#) operatingMode, [telux::common::ResponseCallback](#) callback=nullptr)=0
- virtual [telux::common::Status](#) [resetWwan](#) ([telux::common::ResponseCallback](#) callback=nullptr)=0
- virtual [telux::common::Status](#) [registerListener](#) (std::weak\_ptr< [IphoneListener](#) > listener)=0
- virtual [telux::common::Status](#) [removeListener](#) (std::weak\_ptr< [IphoneListener](#) > listener)=0
- virtual [~IphoneManager](#) ()

##### 4.3.1.36.1 Constructors and Destructors

#### 4.3.1.36.1.1 virtual telux::tel::IphoneManager::~IphoneManager ( ) [virtual]

### 4.3.1.36.2 Member Function Documentation

#### 4.3.1.36.2.1 `virtual bool telux::tel::IPhoneManager::isSubsystemReady ( ) [pure virtual]`

Checks the status of telephony subsystems and returns the result.

#### Returns

If true PhoneManager is ready for service (i.e Phone, Sms and Card).

#### Deprecated

Use [IPhoneManager::getServiceStatus\(\)](#) API.

#### 4.3.1.36.2.2 `virtual std::future<bool> telux::tel::IPhoneManager::onSubsystemReady ( ) [pure virtual]`

Wait for telephony subsystem to be ready.

#### Returns

A future that caller can wait on to be notified when telephony subsystem is ready.

#### Deprecated

Use `InitResponseCb` in [PhoneFactory::getPhoneManager](#) instead, to get notified about subsystem readiness.

#### 4.3.1.36.2.3 `virtual telux::common::ServiceStatus telux::tel::IPhoneManager::getServiceStatus ( ) [pure virtual]`

This status indicates whether the [IPhoneManager](#) object is in a usable state.

#### Returns

`SERVICE_AVAILABLE` - If Phone manager is ready for service. `SERVICE_UNAVAILABLE` - If Phone manager is temporarily unavailable. `SERVICE_FAILED` - If Phone manager encountered an irrecoverable failure.

#### Note

Eval: This is a new API and is being evaluated. It is subject to change and could break backwards compatibility.

#### 4.3.1.36.2.4 `virtual telux::common::Status telux::tel::IPhoneManager::getPhonelds ( std::vector< int > & phonelds ) [pure virtual]`

Retrieves a list of Phone Ids. Each id is unique per phone. For example: on a dual SIM device, there would be 2 Phones.

**Parameters**

out	<i>phoneIds</i>	List of phone ids
-----	-----------------	-------------------

**Returns**

Status of getPhoneIds i.e. success or suitable error code.

#### 4.3.1.36.2.5 `virtual int telux::tel::IPhoneManager::getPhoneIdFromSlotId ( int slotId ) [pure virtual]`

Get the Phone Id for a given Slot Id.

**Parameters**

in	<i>slotId</i>	SIM Card Slot Id
----	---------------	------------------

**Returns**

Phone Id corresponding to the Slot Id.

#### 4.3.1.36.2.6 `virtual int telux::tel::IPhoneManager::getSlotIdFromPhoneId ( int phoneId ) [pure virtual]`

Get the SIM Slot Id for a given Phone Id.

**Parameters**

in	<i>phoneId</i>	Phone Id of the phone
----	----------------	-----------------------

**Returns**

Slot Id corresponding to the Phone Id.

#### 4.3.1.36.2.7 `virtual std::shared_ptr<IPhone> telux::tel::IPhoneManager::getPhone ( int phoneId = DEFAULT_PHONE_ID ) [pure virtual]`

Get the phone instance for a given phone identifier.

**Parameters**

in	<i>phoneId</i>	Identifier for phone instance, retrieved from getPhoneIds API
----	----------------	---

**Returns**

Pointer to Phone object corresponding to phoneId.

**4.3.1.36.2.8** `virtual telux::common::Status telux::tel::IphoneManager::requestCellularCapabilityInfo ( std::shared_ptr< ICellularCapabilityCallback > callback = nullptr ) [pure virtual]`

Get the information about cellular capability.

#### Parameters

in	<i>callback</i>	Optional callback pointer to get the response of cellular capability.
----	-----------------	---

#### Returns

Status of requestCellularCapabilityInfo i.e. success or suitable error code.

**4.3.1.36.2.9** `virtual telux::common::Status telux::tel::IphoneManager::requestOperatingMode ( std::shared_ptr< IOperatingModeCallback > callback = nullptr ) [pure virtual]`

Get current operating mode of the device.

#### Parameters

in	<i>callback</i>	Optional callback pointer to get the response of operating mode request
----	-----------------	---

#### Returns

Status of requestOperatingMode i.e. success or suitable error code.

**4.3.1.36.2.10** `virtual telux::common::Status telux::tel::IphoneManager::setOperatingMode ( OperatingMode operatingMode, telux::common::ResponseCallback callback = nullptr ) [pure virtual]`

Set the operating mode of the device. Only valid transitions allowed from one mode to another.

On platforms with Access control enabled, Caller needs to have TELUX\_TEL\_PHONE\_MGMT permission to invoke this API successfully.

#### Parameters

in	<i>operatingMode</i>	Operating Mode to be set
in	<i>callback</i>	Optional callback pointer to get the response of set operatingmode request. In callback following error is returned. <ul style="list-style-type: none"> <li>• <a href="#">telux::common::ErrorCode::INVALID_TRANSITION</a></li> <li>• <a href="#">telux::common::ErrorCode::INVALID_ARGUMENTS</a></li> <li>• <a href="#">telux::common::ErrorCode::DEVICE_IN_USE</a></li> <li>• <a href="#">telux::common::ErrorCode::NO_MEMORY</a></li> </ul>



**Returns**

Status of setOperatingMode i.e. success or suitable error code.

**4.3.1.36.2.11 virtual telux::common::Status telux::tel::IPhoneManager::resetWwan ( telux::common::↔  
ResponseCallback *callback* = nullptr ) [pure virtual]**

Reset the WWAN stack on the modem without impacting the CV2x stack. This does a soft-reset of some of the subsystems on the modem. Some subsystems like data services is not impacted by this trigger, so it is recommended to stop any WWAN data calls using [telux::data::IDataConnectionManager::stopDataCall](#) before invoking this API. This API will be rejected when under the scenarios of voice call, emergency call, emergency SMS, and emergency call back mode.

On platforms with Access control enabled, Caller needs to have TELUX\_TEL\_PHONE\_MGMT permission to invoke this API successfully.

**Parameters**

in	<i>callback</i>	Optional callback pointer to get the response of WWAN reset request.
----	-----------------	--

**Returns**

Status of resetWwan i.e. success or suitable error code.

**4.3.1.36.2.12 virtual telux::common::Status telux::tel::IPhoneManager::registerListener ( std::weak\_↔  
ptr< IPhoneListener > *listener* ) [pure virtual]**

Register a listener for specific events in the telephony subsystem.

**Parameters**

in	<i>listener</i>	Pointer to Phone Listener object that processes the notification
----	-----------------	--

**Returns**

Status of registerListener i.e. success or suitable error code.

**4.3.1.36.2.13 virtual telux::common::Status telux::tel::IPhoneManager::removeListener ( std::weak\_↔  
ptr< IPhoneListener > *listener* ) [pure virtual]**

Remove a previously added listener.

**Parameters**

in	<i>listener</i>	Pointer to Phone Listener object that needs to be removed
----	-----------------	---

**Returns**

Status of removeListener i.e. success or suitable error code.

### 4.3.1.37 class telux::tel::ICellularCapabilityCallback

Interface for callback corresponding to cellular capability request. Client needs to implement this interface to get single shot responses for commands like get cellular capability.

The methods in callback can be invoked from multiple different threads. The implementation should be thread safe.

#### Public member functions

- virtual void [cellularCapabilityResponse](#) ([CellularCapabilityInfo](#) capabilityInfo, [telux::common::ErrorCode](#) error)
- virtual [~ICellularCapabilityCallback](#) ()

#### 4.3.1.37.1 Constructors and Destructors

4.3.1.37.1.1 virtual [telux::tel::ICellularCapabilityCallback::~~ICellularCapabilityCallback](#) ( )  
[virtual]

#### 4.3.1.37.2 Member Function Documentation

4.3.1.37.2.1 virtual void [telux::tel::ICellularCapabilityCallback::cellularCapabilityResponse](#) ( [CellularCapabilityInfo](#) *capabilityInfo*, [telux::common::ErrorCode](#) *error* ) [virtual]

This function is called with the response to requestCellularCapabilityInfo API.

#### Parameters

in	<i>capabilityInfo</i>	Cellular capability information.
in	<i>error</i>	Return code for whether the operation succeeded or failed <ul style="list-style-type: none"> <li>• <a href="#">telux::common::ErrorCode::SUCCESS</a></li> <li>• <a href="#">telux::common::ErrorCode::INTERNAL</a></li> <li>• <a href="#">telux::common::ErrorCode::NO_MEMORY</a></li> </ul>

### 4.3.1.38 class telux::tel::IOperatingModeCallback

Interface for operating mode callback object. Client needs to implement this interface to get single shot responses for commands like request current operating mode.

The methods in callback can be invoked from multiple different threads. The implementation should be thread safe.

#### Public member functions

- virtual void [operatingModeResponse](#) ([OperatingMode](#) operatingMode, [telux::common::ErrorCode](#) error)
- virtual [~IOperatingModeCallback](#) ()

### 4.3.1.38.1 Constructors and Destructors

4.3.1.38.1.1 `virtual telux::tel::IOperatingModeCallback::~IOperatingModeCallback ( ) [virtual]`

### 4.3.1.38.2 Member Function Documentation

4.3.1.38.2.1 `virtual void telux::tel::IOperatingModeCallback::operatingModeResponse ( OperatingMode operatingMode, telux::common::ErrorCode error ) [virtual]`

This function is called with the response to requestOperatingMode API.

#### Parameters

in	<i>operatingMode</i>	<a href="#">OperatingMode</a>
in	<i>error</i>	Return code for whether the operation succeeded or failed <ul style="list-style-type: none"> <li><a href="#">telux::common::ErrorCode::SUCCESS</a></li> <li><a href="#">telux::common::ErrorCode::INTERNAL_ERR</a></li> <li><a href="#">telux::common::ErrorCode::NO_MEMORY</a></li> </ul>

### 4.3.1.39 class telux::tel::SignalStrength

[SignalStrength](#) class provides access to LTE, GSM, CDMA, WCDMA, TDSCDMA signal strengths.

#### Public member functions

- [SignalStrength](#) (std::shared\_ptr< [LteSignalStrengthInfo](#) > lteSignalStrengthInfo, std::shared\_ptr< [GsmSignalStrengthInfo](#) > gsmSignalStrengthInfo, std::shared\_ptr< [CdmaSignalStrengthInfo](#) > cdmaSignalStrengthInfo, std::shared\_ptr< [WcdmaSignalStrengthInfo](#) > wcdmaSignalStrengthInfo, std::shared\_ptr< [TdscdmaSignalStrengthInfo](#) > tdscdmaSignalStrengthInfo, std::shared\_ptr< [Nr5gSignalStrengthInfo](#) > nr5gSignalStrengthInfo)
- std::shared\_ptr< [LteSignalStrengthInfo](#) > [getLteSignalStrength](#) ()
- std::shared\_ptr< [GsmSignalStrengthInfo](#) > [getGsmSignalStrength](#) ()
- std::shared\_ptr< [CdmaSignalStrengthInfo](#) > [getCdmaSignalStrength](#) ()
- std::shared\_ptr< [WcdmaSignalStrengthInfo](#) > [getWcdmaSignalStrength](#) ()
- std::shared\_ptr< [TdscdmaSignalStrengthInfo](#) > [getTdscdmaSignalStrength](#) ()
- std::shared\_ptr< [Nr5gSignalStrengthInfo](#) > [getNr5gSignalStrength](#) ()

### 4.3.1.39.1 Constructors and Destructors

**4.3.1.39.1.1** `telux::tel::SignalStrength::SignalStrength ( std::shared_ptr< LteSignalStrengthInfo > lteSignalStrengthInfo, std::shared_ptr< GsmSignalStrengthInfo > gsmSignalStrengthInfo, std::shared_ptr< CdmaSignalStrengthInfo > cdmaSignalStrengthInfo, std::shared_ptr< WcdmaSignalStrengthInfo > wcdmaSignalStrengthInfo, std::shared_ptr< TdscdmaSignalStrengthInfo > tdscdmaSignalStrengthInfo, std::shared_ptr< Nr5gSignalStrengthInfo > nr5gSignalStrengthInfo )`

#### 4.3.1.39.2 Member Function Documentation

**4.3.1.39.2.1** `std::shared_ptr<LteSignalStrengthInfo> telux::tel::SignalStrength::getLteSignalStrength ( )`

Gives LTE signal strength instance.

##### Returns

Pointer to LTE signal strength instance that can be used to get lte dbm, signal level values.

**4.3.1.39.2.2** `std::shared_ptr<GsmSignalStrengthInfo> telux::tel::SignalStrength::getGsmSignalStrength ( )`

Gives GSM signal strength instance.

##### Returns

Pointer to GSM signal strength instance that can be used to get GSM dbm, signal level values.

**4.3.1.39.2.3** `std::shared_ptr<CdmaSignalStrengthInfo> telux::tel::SignalStrength::getCdmaSignalStrength ( )`

Gives CDMA signal strength instance.

##### Returns

Pointer to CDMA signal strength instance that can be used to get cdma/evdo dbm, signal level values.

##### Deprecated

As of version 1.53.0 this API is no longer supported.

**4.3.1.39.2.4** `std::shared_ptr<WcdmaSignalStrengthInfo> telux::tel::SignalStrength::getWcdmaSignalStrength ( )`

Gives WCDMA signal strength instance.

##### Returns

Pointer to WCDMA signal strength instance that can be used to get WCDMA dbm, signal level values.

#### 4.3.1.39.2.5 `std::shared_ptr<TdscdmaSignalStrengthInfo> telux::tel::SignalStrength::getTdscdmaSignalStrength ( )`

Gives TDSWCDMA signal strength instance.

##### Returns

Pointer to TDSWCDMA signal strength instance that can be used to get TDSCDMA RSCP value.

##### Deprecated

As of version 1.53.0 this API is no longer supported.

#### 4.3.1.39.2.6 `std::shared_ptr<Nr5gSignalStrengthInfo> telux::tel::SignalStrength::getNr5gSignalStrength ( )`

Gives 5G NR signal strength instance.

##### Returns

Pointer to 5G NR signal strength instance that can be used to get 5G NR dbm and snr values.

### 4.3.1.40 `class telux::tel::LteSignalStrengthInfo`

LTE signal strength class provides methods to get details of lte signals like dbm, signal level, reference signal-to-noise ratio, channel quality indicator and signal strength.

#### Public member functions

- [LteSignalStrengthInfo](#) (int lteSignalStrength, int lteRsrp, int lteRsrq, int lteRssnr, int lteCqi, int timingAdvance)
- const [SignalStrengthLevel](#) getLevel () const
- const int getDbm () const
- const int getLteSignalStrength () const
- const int getLteReferenceSignalReceiveQuality () const
- const int getLteReferenceSignalSnr () const
- const int getLteChannelQualityIndicator () const
- const int getTimingAdvance () const

#### 4.3.1.40.1 Constructors and Destructors

##### 4.3.1.40.1.1 `telux::tel::LteSignalStrengthInfo::LteSignalStrengthInfo ( int lteSignalStrength, int lteRsrp, int lteRsrq, int lteRssnr, int lteCqi, int timingAdvance )`

#### 4.3.1.40.2 Member Function Documentation

##### 4.3.1.40.2.1 `const SignalStrengthLevel telux::tel::LteSignalStrengthInfo::getLevel ( ) const`

Get signal level in the range.

##### Returns

Signal levels indicates the quality of signal being received by the device.

##### 4.3.1.40.2.2 `const int telux::tel::LteSignalStrengthInfo::getDbm ( ) const`

Get the signal strength in dBm. (Valid value range [-140, -44] and INVALID\_SIGNAL\_STRENGTH\_VALUE i.e. unavailable).

##### Returns

LTE dBm value.

##### 4.3.1.40.2.3 `const int telux::tel::LteSignalStrengthInfo::getLteSignalStrength ( ) const`

Get the LTE signal strength. (Valid value range [0, 31] and INVALID\_SIGNAL\_STRENGTH\_VALUE i.e. unavailable).

##### Returns

LTE signal strength.

##### 4.3.1.40.2.4 `const int telux::tel::LteSignalStrengthInfo::getLteReferenceSignalReceiveQuality ( ) const`

Get LTE reference signal receive quality in dB. (Valid value range [-20, -3] and INVALID\_SIGNAL\_STRENGTH\_VALUE i.e. unavailable).

##### Returns

LteRsrq.

##### 4.3.1.40.2.5 `const int telux::tel::LteSignalStrengthInfo::getLteReferenceSignalSnr ( ) const`

Get LTE reference signal signal-to-noise ratio, multiply by 0.1 to get SNR in dB. (Valid value range [-200, +300] and INVALID\_SIGNAL\_STRENGTH\_VALUE i.e. unavailable). (-200 = -20.0 dB, +300 = 30dB).

##### Returns

LteSnr.

#### 4.3.1.40.2.6 `const int telux::tel::LteSignalStrengthInfo::getLteChannelQualityIndicator ( ) const`

Get LTE channel quality indicator. (Valid value range [0, 15] and INVALID\_SIGNAL\_STRENGTH\_VALUE i.e. unavailable).

##### Deprecated

This API not being supported

##### Returns

LteCqI.

##### Deprecated

As of version 1.54.0 this API is no longer supported.

#### 4.3.1.40.2.7 `const int telux::tel::LteSignalStrengthInfo::getTimingAdvance ( ) const`

Get the timing advance in micro seconds. (Valid value range [0, 0x7FFFFFFE] and INVALID\_SIGNAL\_STRENGTH\_VALUE i.e. unavailable).

##### Deprecated

This API not being supported

##### Returns

Timing advance value.

### 4.3.1.41 `class telux::tel::GsmSignalStrengthInfo`

GSM signal strength provides methods to get GSM signal strength in dBm and GSM signal level.

#### Public member functions

- [GsmSignalStrengthInfo](#) (int gsmSignalStrength, int gsmBitErrorRate, int timingAdvance)
- const [SignalStrengthLevel](#) `getLevel ( ) const`
- const int `getDbm ( ) const`
- const int `getGsmSignalStrength ( ) const`
- const int `getGsmBitErrorRate ( ) const`
- const int `getTimingAdvance ( )`

### 4.3.1.41.1 Constructors and Destructors

4.3.1.41.1.1 `telux::tel::GsmSignalStrengthInfo::GsmSignalStrengthInfo ( int gsmSignalStrength, int gsmBitErrorRate, int timingAdvance )`

### 4.3.1.41.2 Member Function Documentation

4.3.1.41.2.1 `const SignalStrengthLevel telux::tel::GsmSignalStrengthInfo::getLevel ( ) const`

Get signal level in the range.

#### Returns

Signal levels indicates the quality of signal being received by the device.

4.3.1.41.2.2 `const int telux::tel::GsmSignalStrengthInfo::getDbm ( ) const`

Get the signal strength in dBm. (Valid value range [-113, -51] and INVALID\_SIGNAL\_STRENGTH\_VALUE i.e. unavailable).

#### Returns

GSM signal strength in dBm.

4.3.1.41.2.3 `const int telux::tel::GsmSignalStrengthInfo::getGsmSignalStrength ( ) const`

Get the GSM signal strength. (Valid value range [0, 31] and INVALID\_SIGNAL\_STRENGTH\_VALUE i.e. unavailable).

#### Returns

GSM signal strength.

4.3.1.41.2.4 `const int telux::tel::GsmSignalStrengthInfo::getGsmBitErrorRate ( ) const`

Get the GSM bit error rate. (Valid value range [0, 7] and INVALID\_SIGNAL\_STRENGTH\_VALUE i.e. unavailable).

#### Deprecated

This API not being supported

#### Returns

GSM bit error rate.



#### 4.3.1.41.2.5 `const int telux::tel::GsmSignalStrengthInfo::getTimingAdvance ( )`

Get the timing advance in bit periods . 1 bit period = 48/13 us (Valid value range [0, 219] and INVALID\_SIGNAL\_STRENGTH\_VALUE i.e. unavailable).

#### Deprecated

This API not being supported

#### Returns

timing advance.

#### 4.3.1.42 `class telux::tel::CdmaSignalStrengthInfo`

CDMA signal strength provides methods to get details of CDMA and EVDO like signal strength in dBm and signal level.

#### Deprecated

As of version 1.53.0 this API is no longer supported.

#### Public member functions

- [CdmaSignalStrengthInfo](#) (int cdmaDbm, int cdmaEcio, int evdoDbm, int evdoEcio, int evdoSignalNoiseRatio)
- `const SignalStrengthLevel getLevel ( ) const`
- `const int getDbm ( ) const`
- `const int getCdmaEcio ( ) const`
- `const int getEvdoEcio ( ) const`
- `const int getEvdoSignalNoiseRatio ( ) const`

#### 4.3.1.42.1 Constructors and Destructors

**4.3.1.42.1.1** `telux::tel::CdmaSignalStrengthInfo::CdmaSignalStrengthInfo ( int cdmaDbm, int cdmaEcio, int evdoDbm, int evdoEcio, int evdoSignalNoiseRatio )`

#### 4.3.1.42.2 Member Function Documentation

**4.3.1.42.2.1** `const SignalStrengthLevel telux::tel::CdmaSignalStrengthInfo::getLevel ( ) const`

Get signal level in the range.

#### Returns

Signal levels indicates the quality of signal being received by the device.

#### 4.3.1.42.2.2 `const int telux::tel::CdmaSignalStrengthInfo::getDbm ( ) const`

Get the signal strength in dBm.

##### Returns

Minimum value of Evdo dBm and Cdma dBm.

#### 4.3.1.42.2.3 `const int telux::tel::CdmaSignalStrengthInfo::getCdmaEcIo ( ) const`

Get the CDMA Ec/Io in dB.

##### Returns

CDMA Ec/Io.

#### 4.3.1.42.2.4 `const int telux::tel::CdmaSignalStrengthInfo::getEvdoEcIo ( ) const`

Get the EVDO Ec/Io in dB.

##### Returns

EVDO Ec/Io.

#### 4.3.1.42.2.5 `const int telux::tel::CdmaSignalStrengthInfo::getEvdoSignalNoiseRatio ( ) const`

Get the EVDO signal noise ratio. (Valid value range [0, 8] and 8 is the highest signal to noise ratio.)

##### Returns

EVDO SNR.

### 4.3.1.43 `class telux::tel::WcdmaSignalStrengthInfo`

WCDMA signal strength provides methods to get WCDMA signal strength in dBm and WCDMA signal level.

#### Public member functions

- [WcdmaSignalStrengthInfo](#) (int signalStrength, int bitErrorRate)
- `const SignalStrengthLevel getLevel ( ) const`
- `const int getDbm ( ) const`
- `const int getSignalStrength ( ) const`
- `const int getBitErrorRate ( ) const`

### 4.3.1.43.1 Constructors and Destructors

4.3.1.43.1.1 `telux::tel::WcdmaSignalStrengthInfo::WcdmaSignalStrengthInfo ( int signalStrength, int bitErrorRate )`

### 4.3.1.43.2 Member Function Documentation

4.3.1.43.2.1 `const SignalStrengthLevel telux::tel::WcdmaSignalStrengthInfo::getLevel ( ) const`

Get signal level in the range.

#### Returns

Signal levels indicates the quality of signal being received by the device.

4.3.1.43.2.2 `const int telux::tel::WcdmaSignalStrengthInfo::getDbm ( ) const`

Get the signal strength in dBm. (Valid value range [-113, -51] and INVALID\_SIGNAL\_STRENGTH\_VALUE i.e. unavailable).

#### Returns

WCDMA signal strength in dBm.

4.3.1.43.2.3 `const int telux::tel::WcdmaSignalStrengthInfo::getSignalStrength ( ) const`

Get the WCDMA signal strength. (Valid value range [0, 31] and INVALID\_SIGNAL\_STRENGTH\_VALUE i.e. unavailable).

#### Returns

WCDMA signal strength.

4.3.1.43.2.4 `const int telux::tel::WcdmaSignalStrengthInfo::getBitErrorRate ( ) const`

Get the WCDMA bit error rate. (Valid value range [0, 7] and INVALID\_SIGNAL\_STRENGTH\_VALUE i.e. unavailable).

#### Deprecated

This API not being supported

#### Returns

WCDMA bit error rate.

#### 4.3.1.44 class telux::tel::TdscdmaSignalStrengthInfo

Tdscdma signal strength provides methods to get received signal code power.

##### Deprecated

As of version 1.53.0 this API is no longer supported.

##### Public member functions

- [TdscdmaSignalStrengthInfo](#) (int rscp)
- const int [getRscp](#) () const

##### 4.3.1.44.1 Constructors and Destructors

4.3.1.44.1.1 `telux::tel::TdscdmaSignalStrengthInfo::TdscdmaSignalStrengthInfo ( int rscp )`

##### 4.3.1.44.2 Member Function Documentation

4.3.1.44.2.1 `const int telux::tel::TdscdmaSignalStrengthInfo::getRscp ( ) const`

Get TdScdma received signal code power in dBm. (Valid Range [-120,-25], and INVALID\_SIGNAL\_STRENGTH\_VALUE i.e. unavailable).

##### Returns

TdScdma signal code power.

#### 4.3.1.45 class telux::tel::Nr5gSignalStrengthInfo

5G NR signal strength provides methods to get signal strength and signal-to-noise ratio.

##### Public member functions

- [Nr5gSignalStrengthInfo](#) (int rsrp, int rsrq, int rssnr)
- const [SignalStrengthLevel](#) [getLevel](#) () const
- const int [getDbm](#) () const
- const int [getReferenceSignalReceiveQuality](#) () const
- const int [getReferenceSignalSnr](#) () const

##### 4.3.1.45.1 Constructors and Destructors

4.3.1.45.1.1 `telux::tel::Nr5gSignalStrengthInfo::Nr5gSignalStrengthInfo ( int rsrp, int rsrq, int rssnr )`

### 4.3.1.45.2 Member Function Documentation

#### 4.3.1.45.2.1 `const SignalStrengthLevel telx::tel::Nr5gSignalStrengthInfo::getLevel ( ) const`

Get signal level in the range.

#### Returns

Signal levels indicates the quality of signal being received by the device.

#### 4.3.1.45.2.2 `const int telx::tel::Nr5gSignalStrengthInfo::getDbm ( ) const`

Get the signal strength in dBm. (Valid value range [-140, -44] and INVALID\_SIGNAL\_STRENGTH\_VALUE i.e. unavailable). INVALID\_SIGNAL\_STRENGTH\_VALUE indicates that modem is not in ENDC connected mode.

#### Returns

5G NR dBm value.

#### 4.3.1.45.2.3 `const int telx::tel::Nr5gSignalStrengthInfo::getReferenceSignalReceiveQuality ( ) const`

Get 5G NR reference signal receive quality in dB. (Valid value range [-20, -3] and INVALID\_SIGNAL\_STRENGTH\_VALUE i.e. unavailable). INVALID\_SIGNAL\_STRENGTH\_VALUE indicates that modem is not in ENDC connected mode.

#### Returns

5G NR rsrq.

#### 4.3.1.45.2.4 `const int telx::tel::Nr5gSignalStrengthInfo::getReferenceSignalSnr ( ) const`

Get 5G NR reference signal signal-to-noise ratio, multiply by 0.1 to get SNR in dB. (Valid value range [-200, +300] and INVALID\_SIGNAL\_STRENGTH\_VALUE i.e. unavailable). (-200 = -20.0 dB, +300 = 30dB). INVALID\_SIGNAL\_STRENGTH\_VALUE indicates that modem is not in ENDC connected mode.

#### Returns

5G NR signal-to-noise.

### 4.3.1.46 `class telx::tel::VoiceServiceInfo`

[VoiceServiceInfo](#) is a container class for obtaining serving state details like phone is registered to home network, roaming, in service, out of service or only emergency calls allowed.

#### Public member functions

- [VoiceServiceInfo](#) ([VoiceServiceState](#) voiceServiceState, [VoiceServiceDenialCause](#) denialCause, [RadioTechnology](#) radioTech)

- [VoiceServiceState](#) `getVoiceServiceState ()`
- [VoiceServiceDenialCause](#) `getVoiceServiceDenialCause ()`
- `bool isEmergency ()`
- `bool isInService ()`
- `bool isOutOfService ()`
- [RadioTechnology](#) `getRadioTechnology ()`

#### 4.3.1.46.1 Constructors and Destructors

**4.3.1.46.1.1** `telux::tel::VoiceServiceInfo::VoiceServiceInfo ( VoiceServiceState voiceServiceState, VoiceServiceDenialCause denialCause, RadioTechnology radioTech )`

#### 4.3.1.46.2 Member Function Documentation

**4.3.1.46.2.1** `VoiceServiceState telux::tel::VoiceServiceInfo::getVoiceServiceState ( )`

Get voice service state.

##### Returns

[VoiceServiceState](#)

**4.3.1.46.2.2** `VoiceServiceDenialCause telux::tel::VoiceServiceInfo::getVoiceServiceDenialCause ( )`

Get Voice service denial cause

##### Returns

[VoiceServiceDenialCause](#)

**4.3.1.46.2.3** `bool telux::tel::VoiceServiceInfo::isEmergency ( )`

Check if phone service is in emergency mode (i.e Only emergency numbers are allowed)

**4.3.1.46.2.4** `bool telux::tel::VoiceServiceInfo::isInService ( )`

Check if phone is registered to home network or roaming network, phone is in service mode

**4.3.1.46.2.5** `bool telux::tel::VoiceServiceInfo::isOutOfService ( )`

check if phone not registered, phone is in out of service mode

**4.3.1.46.2.6 RadioTechnology telux::tel::VoiceServiceInfo::getRadioTechnology ( )**

Get voice radio technology

**Returns**

[RadioTechnology](#)

**4.3.1.47 union telux::tel::SignalStrengthConfig.\_\_unnamed\_\_**

Signal strength data.

**Data fields**

Type	Field	Description
uint16_t	delta	Signal strength delta.
<a href="#">SignalStrengthThreshold</a>	threshold	Signal strength threshold.

**4.3.2 Enumeration Type Documentation****4.3.2.1 enum telux::tel::CellType [strong]**

Defines all the cell info types.

**Enumerator**

**GSM**  
**CDMA**  
**LTE**  
**WCDMA**  
**TDSCDMA**  
**NR5G**

**4.3.2.2 enum telux::tel::ECallVariant [strong]**

ECall Variant

**Enumerator**

**ECALL\_TEST** Initiate a test voice eCall with a configured telephone number stored in the USIM.  
**ECALL\_EMERGENCY** Initiate an emergency eCall. The trigger can be a manually initiated eCall or automatically initiated eCall.  
**ECALL\_VOICE** Initiate a regular voice call with capability to transfer an MSD.

**4.3.2.3 enum telux::tel::EmergencyCallType [strong]**

Emergency Call Type

**Enumerator**

**CALL\_TYPE\_ECALL** eCall (0x0C)

**4.3.2.4 enum telux::tel::ECallMsdTransmissionStatus [strong]**

MSD Transmission Status

**Enumerator**

**SUCCESS** In-band MSD transmission is successful

**FAILURE** In-band MSD transmission failed

**MSD\_TRANSMISSION\_STARTED** In-band MSD transmission started

**NACK\_OUT\_OF\_ORDER** Out of order NACK message detected during in-band MSD transmission

**ACK\_OUT\_OF\_ORDER** Out of order ACK message detected during in-band MSD transmission

**START\_RECEIVED** SEND-MSD(START) is received and SYNC is locked during in-band MSD transmission

**LL\_ACK\_RECEIVED** Link-Layer Acknowledgement(LL-ACK) is received during in-band MSD transmission

**OUTBAND\_MSD\_TRANSMISSION\_STARTED** Outband MSD transmission started in NG eCall

**OUTBAND\_MSD\_TRANSMISSION\_SUCCESS** Outband MSD transmission succeeded in NG eCall or Third Party Service (TPS) eCall

**OUTBAND\_MSD\_TRANSMISSION\_FAILURE** Outband MSD transmission failed in NG eCall or Third Party Service (TPS) eCall

**4.3.2.5 enum telux::tel::ECallCategory [strong]**

ECall category

**Enumerator**

**VOICE\_EMER\_CAT\_AUTO\_ECALL** Automatic emergency call

**VOICE\_EMER\_CAT\_MANUAL** Manual emergency call

**4.3.2.6 enum telux::tel::ECallVehicleType**

Represents a vehicle class as per European eCall MSD standard. i.e. EN 15722:2020. Some of these values are only supported in certain MSD versions, so ensure to use supported values in an MSD. For example, TRAILERS\_CLASS\_O is not supported in MSD version-2 (as per A.1 in EN 15722:2015(E)), but supported in in MSD version-3 (as per A.1 in EN 15722:2020).

**Enumerator**

**PASSENGER\_VEHICLE\_CLASS\_M1**

**BUSES\_AND\_COACHES\_CLASS\_M2**

**BUSES\_AND\_COACHES\_CLASS\_M3**

**LIGHT\_COMMERCIAL\_VEHICLES\_CLASS\_N1**

**HEAVY\_DUTY\_VEHICLES\_CLASS\_N2**

**HEAVY\_DUTY\_VEHICLES\_CLASS\_N3**

**MOTOR\_CYCLES\_CLASS\_L1E**

**MOTOR\_CYCLES\_CLASS\_L2E**

**MOTOR\_CYCLES\_CLASS\_L3E**



**MOTOR\_CYCLES\_CLASS\_L4E**  
**MOTOR\_CYCLES\_CLASS\_L5E**  
**MOTOR\_CYCLES\_CLASS\_L6E**  
**MOTOR\_CYCLES\_CLASS\_L7E**  
**TRAILERS\_CLASS\_O**  
**AGRI\_VEHICLES\_CLASS\_R**  
**AGRI\_VEHICLES\_CLASS\_S**  
**AGRI\_VEHICLES\_CLASS\_T**  
**OFF\_ROAD\_VEHICLES\_G**  
**SPECIAL\_PURPOSE\_MOTOR\_CARAVAN\_CLASS\_SA**  
**SPECIAL\_PURPOSE\_ARMOURED\_VEHICLE\_CLASS\_SB**  
**SPECIAL\_PURPOSE\_AMBULANCE\_CLASS\_SC**  
**SPECIAL\_PURPOSE\_HEARCE\_CLASS\_SD**  
**OTHER\_VEHICLE\_CLASS**

#### 4.3.2.7 enum telux::tel::ECallOptionalDataType [strong]

Represents OptionalDataType class as per European eCall MSD standard. i.e. EN 15722.

##### Enumerator

**ECALL\_DEFAULT**

#### 4.3.2.8 enum telux::tel::ECallMode [strong]

Represents eCall operating mode

##### Enumerator

**NORMAL** eCall and normal voice calls are allowed  
**ECALL\_ONLY** Only eCall is allowed  
**NONE** Invalid mode

#### 4.3.2.9 enum telux::tel::ECallModeReason [strong]

Represents eCall operating mode change reason

##### Enumerator

**NORMAL** eCall operating mode changed due to normal operation like setting of eCall mode  
**ERA\_GLONASS** eCall operating mode changed due to ERA-GLONASS operation

#### 4.3.2.10 enum telux::tel::HlapTimerStatus [strong]

Represents the status of an eCall High Level Application Protocol(HLAP) timer that is maintained by the UE state machine.

##### Enumerator

**UNKNOWN** Unknown  
**INACTIVE** eCall Timer is Inactive i.e it has not started or it has stopped/expired

**ACTIVE** eCall Timer is Active i.e it has started but not yet stopped/expired

#### 4.3.2.11 enum telux::tel::HlapTimerEvent [strong]

Represents an event causing a change in the the status of eCall High Level Application Protocol (HLAP) timer that is maintained by the UE state machine.

Timer STARTED notification is provided when the timer moves from INACTIVE to ACTIVE state. Timer STOPPED notification is provided when the timer moves from ACTIVE to INACTIVE state, after its underlying condition is satisfied. Timer EXPIRED notification is provided when the timer moves from ACTIVE to INACTIVE state, after its underlying condition not satisfied until its timeout.

##### Enumerator

**UNKNOWN** Unknown  
**UNCHANGED** No change in timer status  
**STARTED** eCall Timer is Started  
**STOPPED** eCall Timer is Stopped  
**EXPIRED** eCall Timer is expired

#### 4.3.2.12 enum telux::tel::HlapTimerType [strong]

Represents the type of an eCall High Level Application Protocol(HLAP) timer that is maintained by the UE state machine. The timers are represented according to EN 16062:2015 standard.

##### Enumerator

**UNKNOWN\_TIMER** eCall unknown timer  
**T2\_TIMER** eCall T2 timer  
**T5\_TIMER** eCall T5 timer  
**T6\_TIMER** eCall T6 timer  
**T7\_TIMER** eCall T7 timer  
**T9\_TIMER** eCall T9 timer  
**T10\_TIMER** eCall T10 timer

#### 4.3.2.13 enum telux::tel::ECallNumType [strong]

Configuration that represents the type of the number to be dialed when an automotive emergency call is initiated.

##### Enumerator

**DEFAULT**  
**OVERRIDDEN**

#### 4.3.2.14 enum telux::tel::EcallConfigType

Defines the supported ECall configuration parameters

##### Enumerator

**ECALL\_CONFIG\_MUTE\_RX\_AUDIO** Mute the local audio device during MSD transmission

**ECALL\_CONFIG\_NUM\_TYPE** Decides which number needs to be dialed when an eCall is initiated

**ECALL\_CONFIG\_OVERRIDDEN\_NUM** User configured/overridden number that will be dialed for eCall

**ECALL\_CONFIG\_USE\_CANNED\_MSD** Use the pre-defined MSD in modem for eCall

**ECALL\_CONFIG\_GNSS\_UPDATE\_INTERVAL** Time interval in milliseconds, at which modem updates the GNSS information in its internally generated MSD

**ECALL\_CONFIG\_T2\_TIMER** T2 timer value

**ECALL\_CONFIG\_T7\_TIMER** T7 timer value

**ECALL\_CONFIG\_T9\_TIMER** T9 timer value

**ECALL\_CONFIG\_MSD\_VERSION** MSD version to be used by modem when it internally generates MSD i.e when MSD is not sent by application and also canned MSD is not used

**ECALL\_CONFIG\_COUNT**

#### 4.3.2.15 enum telux::tel::RadioState [strong]

Defines the radio state

##### Enumerator

**RADIO\_STATE\_OFF** Radio is explicitly powered off

**RADIO\_STATE\_UNAVAILABLE** Radio unavailable (eg, resetting or not booted)

**RADIO\_STATE\_ON** Radio is on

#### 4.3.2.16 enum telux::tel::ServiceState [strong]

Defines the service states

##### Deprecated

Use requestVoiceServiceState() API or to know the status of phone

##### Enumerator

**EMERGENCY\_ONLY** Only emergency calls allowed

**IN\_SERVICE** Normal operation, device is registered with a carrier and online

**OUT\_OF\_SERVICE** Device is not registered with any carrier

**RADIO\_OFF** Device radio is off - Airplane mode for example

#### 4.3.2.17 enum telux::tel::RadioTechnology [strong]

Defines all available radio access technologies

##### Enumerator

**RADIO\_TECH\_UNKNOWN** Network type is unknown

**RADIO\_TECH\_GPRS** Network type is GPRS

**RADIO\_TECH\_EDGE** Network type is EDGE

**RADIO\_TECH\_UMTS** Network type is UMTS

**RADIO\_TECH\_IS95A** Network type is IS95A

**RADIO\_TECH\_IS95B** Network type is IS95B

**RADIO\_TECH\_1xRTT** Network type is 1xRTT  
**RADIO\_TECH\_EVDO\_0** Network type is EVDO revision 0  
**RADIO\_TECH\_EVDO\_A** Network type is EVDO revision A  
**RADIO\_TECH\_HSDPA** Network type is HSDPA  
**RADIO\_TECH\_HSUPA** Network type is HSUPA  
**RADIO\_TECH\_HSPA** Network type is HSPA  
**RADIO\_TECH\_EVDO\_B** Network type is EVDO revision B  
**RADIO\_TECH\_EHRPD** Network type is eHRPD  
**RADIO\_TECH\_LTE** Network type is LTE  
**RADIO\_TECH\_HSPAP** Network type is HSPA+  
**RADIO\_TECH\_GSM** Network type is GSM, Only supports voice  
**RADIO\_TECH\_TD\_SCDMA** Network type is TD SCDMA  
**RADIO\_TECH\_IWLAN** Network type is TD IWLAN  
**RADIO\_TECH\_LTE\_CA** Network type is LTE CA  
**RADIO\_TECH\_NR5G** Network type is NR5G

#### 4.3.2.18 enum telux::tel::RATCapability [strong]

Defines all available RAT capabilities for each subscription

##### Enumerator

**AMPS**  
**CDMA**  
**HDR**  
**GSM**  
**WCDMA**  
**LTE**  
**TDS**  
**NR5G** NR5G NSA mode  
**NR5GSA** NR5G SA mode

#### 4.3.2.19 enum telux::tel::VoiceServiceTechnology [strong]

Defines all voice support available on device

##### Enumerator

**VOICE\_TECH\_GW\_CSFB**  
**VOICE\_TECH\_1x\_CSFB**  
**VOICE\_TECH\_VOLTE**

#### 4.3.2.20 enum telux::tel::OperatingMode [strong]

Defines operating modes of the device.

##### Enumerator

**ONLINE** Online mode  
**AIRPLANE** Low Power mode i.e temporarily disabled RF  
**FACTORY\_TEST** Special mode for manufacturer use

**OFFLINE** Device has deactivated RF and partially shutdown  
**RESETTING** Device is in process of power cycling  
**SHUTTING\_DOWN** Device is in process of shutting down  
**PERSISTENT\_LOW\_POWER** Persists low power mode even on reset

#### 4.3.2.21 enum telux::tel::EcbMode [strong]

Emergency callback mode

##### Enumerator

**NORMAL** Device is not in emergency callback mode(ECBM)  
**EMERGENCY** Device is in emergency callback mode(ECBM)

#### 4.3.2.22 enum telux::tel::RadioSignalStrengthType [strong]

Defines the radio [SignalStrength](#) types for delta or threshold.

##### Enumerator

**GSM\_RSSI** GSM received signal strength indicator.  
**WCDMA\_RSSI** WCDMA received signal strength indicator.  
**LTE\_RSSI** LTE received signal strength indicator.  
**LTE\_SNR** LTE signal-to-noise ratio.  
**LTE\_RSRQ** LTE reference signal received quality.  
**LTE\_RSRP** LTE reference signal received power.  
**NR5G\_SNR** NR5G signal-to-noise ratio.  
**NR5G\_RSRP** NR5G reference signal received power.  
**NR5G\_RSRQ** NR5G reference signal received quality.

#### 4.3.2.23 enum telux::tel::SignalStrengthConfigType [strong]

Defines the [SignalStrength](#) configuration parameters.

##### Enumerator

**DELTA** Signal strength delta provided.  
**THRESHOLD** Signal strength threshold provided.

#### 4.3.2.24 enum telux::tel::SignalStrengthLevel [strong]

Defines all the signal levels that [SignalStrength](#) class can return where level 1 is low and level 5 is high.

##### Enumerator

**LEVEL\_1**  
**LEVEL\_2**  
**LEVEL\_3**  
**LEVEL\_4**  
**LEVEL\_5**  
**LEVEL\_UNKNOWN**

#### 4.3.2.25 enum telx::tel::VoiceServiceState [strong]

Defines the voice service states

##### Enumerator

- NOT\_REG\_AND\_NOT\_SEARCHING** Not registered, MT is not currently searching a new operator to register
- REG\_HOME** Registered, home network
- NOT\_REG\_AND\_SEARCHING** Not registered, but MT is currently searching a new operator to register
- REG\_DENIED** Registration denied
- UNKNOWN** Unknown
- REG\_ROAMING** Registered, roaming
- NOT\_REG\_AND\_EMERGENCY\_AVAILABLE\_AND\_NOT\_SEARCHING** Same as NOT\_REG\_AND\_NOT\_SEARCHING but indicates that emergency calls are enabled
- NOT\_REG\_AND\_EMERGENCY\_AVAILABLE\_AND\_SEARCHING** Same as NOT\_REG\_AND\_SEARCHING but indicates that emergency calls are enabled
- REG\_DENIED\_AND\_EMERGENCY\_AVAILABLE** Same as REG\_DENIED but indicates that emergency calls are enabled
- UNKNOWN\_AND\_EMERGENCY\_AVAILABLE** Same as UNKNOWN but indicates that emergency calls are enabled

#### 4.3.2.26 enum telx::tel::VoiceServiceDenialCause [strong]

Defines the voice service denial cause why voice service state registration was denied See 3GPP TS 24.008, 10.5.3.6 and Annex G.

##### Enumerator

- UNDEFINED** Undefined
- GENERAL** General
- AUTH\_FAILURE** Authentication Failure
- IMSI\_UNKNOWN** IMSI unknown in HLR
- ILLEGAL\_MS** Illegal Mobile Station (MS), network refuses service to the MS either because an identity of the MS is not acceptable to the network or because the MS does not pass the authentication check
- IMSI\_UNKNOWN\_VLR** IMSI unknown in Visitors Location Register (VLR)
- IMEI\_NOT\_ACCEPTED** Network does not accept emergency call establishment using an IMEI or not accept attach procedure for emergency services using an IMEI
- ILLEGAL\_ME** ME used is not acceptable to the network
- GPRS\_SERVICES\_NOT\_ALLOWED** Not allowed to operate GPRS services.
- GPRS\_NON\_GPRS\_NOT\_ALLOWED** Not allowed to operate either GPRS or non-GPRS services
- MS\_IDENTITY\_FAILED** the network cannot derive the MS's identity from the P-TMSI/GUTI.
- IMPLICITLY\_DETACHED** network has implicitly detached the MS
- GPRS\_NOT\_ALLOWED\_IN\_PLMN** GPRS services not allowed in this PLMN
- MSC\_TEMPORARILY\_NOT\_REACHABLE** MSC temporarily not reachable
- SMS\_PROVIDED\_VIA\_GPRS** SMS provided via GPRS in this routing area
- NO\_PDP\_CONTEXT\_ACTIVATED** No PDP context activated
- PLMN\_NOT\_ALLOWED** if the network initiates a detach request or UE requests a services, in a PLMN where the MS, by subscription or due to operator determined barring is not allowed to

operate.

**LOCATION\_AREA\_NOT\_ALLOWED** network initiates a detach request, in a location area where the HPLMN determines that the MS, by subscription, is not allowed to operate or roaming subscriber the subscriber is denied service even if other PLMNs are available on which registration was possible

**ROAMING\_NOT\_ALLOWED** Roaming not allowed in this Location Area

**NO\_SUITABLE\_CELLS** No Suitable Cells in this Location Area

**NOT\_AUTHORIZED** Not Authorized for this CSG

**NETWORK\_FAILURE** Network Failure

**MAC\_FAILURE** MAC failure

**SYNC\_FAILURE** USIM detects that the SQN in the AUTHENTICATION REQUEST or AUTHENTICATION\_AND\_CIPHERING REQUEST message is out of range

**CONGESTION** network cannot serve a request from the MS because of congestion

**GSM\_AUTHENTICATION\_UNACCEPTABLE** GSM Authentication unacceptable

**SERVICE\_OPTION\_NOT\_SUPPORTED** Service option not supported

**SERVICE\_OPTION\_NOT\_SUBSCRIBED** Requested service option not subscribed

**SERVICE\_OPTION\_OUT\_OF\_ORDER** Service option temporarily out of order

**CALL\_NOT\_IDENTIFIED** Call cannot be identified

**RETRY\_FOR\_NEW\_CELL** Retry upon entry into a new cell

**INCORRECT\_MESSAGE** Semantically incorrect message

**INVALID\_INFO** Invalid mandatory information

**MSG\_TYPE\_NOT\_IMPLEMENTED** Message type non-existent or not implemented

**MSG\_NOT\_COMPATIBLE** Message not compatible with protocol state

**INFO\_NOT\_IMPLEMENTED** Information element non-existent or not implemented

**CONDITIONAL\_IE\_ERROR** Conditional IE error

**PROTOCOL\_ERROR\_UNSPECIFIED** Protocol error, unspecified

### 4.3.3 Variable Documentation

**4.3.3.1** `const std::string telux::tel::CONTENT_HEADER = "application/Emergency↔  
CallData.eCall.MSD" [static]`

Default value for [CustomSipHeader::contentType](#)

## 4.4 Call

This section contains APIs related to Call.

### 4.4.1 Data Structure Documentation

#### 4.4.1.1 class telux::tel::ICall

**ICall** represents a call in progress. An **ICall** cannot be directly created by the client, rather it is returned as a result of instantiating a call or from the PhoneListener when receiving an incoming call.

##### Public member functions

- virtual [telux::common::Status answer](#) (std::shared\_ptr< [telux::common::ICommandResponseCallback](#) > callback=nullptr)=0
- virtual [telux::common::Status hold](#) (std::shared\_ptr< [telux::common::ICommandResponseCallback](#) > callback=nullptr)=0
- virtual [telux::common::Status resume](#) (std::shared\_ptr< [telux::common::ICommandResponseCallback](#) > callback=nullptr)=0
- virtual [telux::common::Status reject](#) (std::shared\_ptr< [telux::common::ICommandResponseCallback](#) > callback=nullptr)=0
- virtual [telux::common::Status reject](#) (const std::string &rejectSMS, std::shared\_ptr< [telux::common::ICommandResponseCallback](#) > callback=nullptr)=0
- virtual [telux::common::Status hangup](#) (std::shared\_ptr< [telux::common::ICommandResponseCallback](#) > callback=nullptr)=0
- virtual [telux::common::Status playDtmfTone](#) (char tone, std::shared\_ptr< [telux::common::ICommandResponseCallback](#) > callback=nullptr)=0
- virtual [telux::common::Status startDtmfTone](#) (char tone, std::shared\_ptr< [telux::common::ICommandResponseCallback](#) > callback=nullptr)=0
- virtual [telux::common::Status stopDtmfTone](#) (std::shared\_ptr< [telux::common::ICommandResponseCallback](#) > callback=nullptr)=0
- virtual [CallState getCallState](#) ()=0
- virtual int [getCallIndex](#) ()=0
- virtual [CallDirection getCallDirection](#) ()=0
- virtual std::string [getRemotePartyNumber](#) ()=0
- virtual [CallEndCause getCallEndCause](#) ()=0
- virtual int [getPhoneId](#) ()=0
- virtual bool [isMultiPartyCall](#) ()=0
- virtual [~ICall](#) ()



#### 4.4.1.1.1 Constructors and Destructors

4.4.1.1.1.1 virtual `telux::tel::ICall::~ICall ( )` [virtual]

#### 4.4.1.1.2 Member Function Documentation

4.4.1.1.2.1 virtual `telux::common::Status telux::tel::ICall::answer ( std::shared_ptr< telux::common::ICommandResponseCallback > callback = nullptr )` [pure virtual]

Allows the client to answer the call. This is only applicable for `CallState::INCOMING` and `CallState::WAITING` calls. If a Waiting call is being answered and the existing call is Active, then existing call will move to Hold state. If the existing call is on Hold already, then it will remain on Hold. The waiting call state transition from Waiting to Active.

On platforms with Access control enabled, Caller needs to have `TELUX_TEL_CALL_MGMT` permission to invoke this API successfully.

#### Parameters

<code>in</code>	<code>callback</code>	<p>- optional callback pointer to get the response of answer request below are possible error codes for callback response</p> <ul style="list-style-type: none"> <li>• <code>telux::common::ErrorCode::SUCCESS</code></li> <li>• <code>telux::common::ErrorCode::RADIO_NOT_AVAILABLE</code></li> <li>• <code>telux::common::ErrorCode::NO_MEMORY</code></li> <li>• <code>telux::common::ErrorCode::MODEM_ERR</code></li> <li>• <code>telux::common::ErrorCode::INTERNAL_ERR</code></li> <li>• <code>telux::common::ErrorCode::INVALID_STATE</code></li> <li>• <code>telux::common::ErrorCode::INVALID_CALL_ID</code></li> <li>• <code>telux::common::ErrorCode::INVALID_ARGUMENTS</code></li> <li>• <code>telux::common::ErrorCode::OPERATION_NOT_ALLOWED</code></li> <li>• <code>telux::common::ErrorCode::GENERIC_FAILURE</code></li> </ul>
-----------------	-----------------------	---

#### Returns

Status of hold function i.e. success or suitable error code.

4.4.1.1.2.2 virtual `telux::common::Status telux::tel::ICall::hold ( std::shared_ptr< telux::common::ICommandResponseCallback > callback = nullptr )` [pure virtual]

Puts the ongoing call on hold.

On platforms with Access control enabled, Caller needs to have `TELUX_TEL_CALL_MGMT` permission to invoke this API successfully.

**Parameters**

in	<i>callback</i>	<p>- optional callback pointer to get the response of hold request below are possible error codes for callback response</p> <ul style="list-style-type: none"> <li>• <a href="#">telux::common::ErrorCode::SUCCESS</a></li> <li>• <a href="#">telux::common::ErrorCode::RADIO_NOT_AVAILABLE</a></li> <li>• <a href="#">telux::common::ErrorCode::NO_MEMORY</a></li> <li>• <a href="#">telux::common::ErrorCode::MODEM_ERR</a></li> <li>• <a href="#">telux::common::ErrorCode::INTERNAL_ERR</a></li> <li>• <a href="#">telux::common::ErrorCode::INVALID_STATE</a></li> <li>• <a href="#">telux::common::ErrorCode::INVALID_CALL_ID</a></li> <li>• <a href="#">telux::common::ErrorCode::INVALID_ARGUMENTS</a></li> <li>• <a href="#">telux::common::ErrorCode::OPERATION_NOT_ALLOWED</a></li> <li>• <a href="#">telux::common::ErrorCode::GENERIC_FAILURE</a></li> </ul>
----	-----------------	---

**Returns**

Status of hold function i.e. success or suitable error code.

#### 4.4.1.1.2.3 virtual `telux::common::Status telux::tel::ICall::resume ( std::shared_ptr< telux::common::ICommandResponseCallback > callback = nullptr ) [pure virtual]`

Resumes this call from on-hold state to active state

On platforms with Access control enabled, Caller needs to have TELUX\_TEL\_CALL\_MGMT permission to invoke this API successfully.

**Parameters**

in	<i>callback</i>	<p>- optional callback pointer to get the response of resume request below are possible error codes for callback response</p> <ul style="list-style-type: none"> <li>• <a href="#">telux::common::ErrorCode::SUCCESS</a></li> <li>• <a href="#">telux::common::ErrorCode::RADIO_NOT_AVAILABLE</a></li> <li>• <a href="#">telux::common::ErrorCode::NO_MEMORY</a></li> <li>• <a href="#">telux::common::ErrorCode::MODEM_ERR</a></li> <li>• <a href="#">telux::common::ErrorCode::INTERNAL_ERR</a></li> <li>• <a href="#">telux::common::ErrorCode::INVALID_STATE</a></li> <li>• <a href="#">telux::common::ErrorCode::INVALID_CALL_ID</a></li> <li>• <a href="#">telux::common::ErrorCode::INVALID_ARGUMENTS</a></li> <li>• <a href="#">telux::common::ErrorCode::OPERATION_NOT_ALLOWED</a></li> <li>• <a href="#">telux::common::ErrorCode::GENERIC_FAILURE</a></li> </ul>
----	-----------------	---

**Returns**

Status of resume function i.e. success or suitable error code.

#### 4.4.1.1.2.4 `virtual telux::common::Status telux::tel::ICall::reject ( std::shared_ptr< telux::common::ICommandResponseCallback > callback = nullptr ) [pure virtual]`

Reject the incoming/waiting call. Only applicable for `CallState::INCOMING` and `CallState::WAITING` calls.

On platforms with Access control enabled, Caller needs to have `TELUX_TEL_CALL_MGMT` permission to invoke this API successfully.

#### Parameters

in	<i>callback</i>	<p>- optional callback pointer to get the response of reject request below are possible error codes for callback response</p> <ul style="list-style-type: none"> <li>• <code>telux::common::ErrorCode::SUCCESS</code></li> <li>• <code>telux::common::ErrorCode::RADIO_NOT_AVAILABLE</code></li> <li>• <code>telux::common::ErrorCode::NO_MEMORY</code></li> <li>• <code>telux::common::ErrorCode::MODEM_ERR</code></li> <li>• <code>telux::common::ErrorCode::INTERNAL_ERR</code></li> <li>• <code>telux::common::ErrorCode::INVALID_STATE</code></li> <li>• <code>telux::common::ErrorCode::INVALID_CALL_ID</code></li> <li>• <code>telux::common::ErrorCode::INVALID_ARGUMENTS</code></li> <li>• <code>telux::common::ErrorCode::OPERATION_NOT_ALLOWED</code></li> <li>• <code>telux::common::ErrorCode::GENERIC_FAILURE</code></li> </ul>
----	-----------------	---

#### Returns

Status of reject function i.e. success or suitable error code.

#### 4.4.1.1.2.5 `virtual telux::common::Status telux::tel::ICall::reject ( const std::string & rejectSMS, std::shared_ptr< telux::common::ICommandResponseCallback > callback = nullptr ) [pure virtual]`

Reject the call and send an SMS to caller. Only applicable for `CallState::INCOMING` and `CallState::WAITING` calls.

On platforms with Access control enabled, Caller needs to have `TELUX_TEL_CALL_MGMT` permission to invoke this API successfully.

**Parameters**

in	<i>rejectSMS</i>	SMS string used to send in response to a call rejection.
in	<i>callback</i>	- optional callback pointer to get the response of rejectwithSMS request below are possible error codes for callback response <ul style="list-style-type: none"> <li>• <a href="#">telux::common::ErrorCode::SUCCESS</a></li> <li>• <a href="#">telux::common::ErrorCode::RADIO_NOT_AVAILABLE</a></li> <li>• <a href="#">telux::common::ErrorCode::NO_MEMORY</a></li> <li>• <a href="#">telux::common::ErrorCode::MODEM_ERR</a></li> <li>• <a href="#">telux::common::ErrorCode::INTERNAL_ERR</a></li> <li>• <a href="#">telux::common::ErrorCode::INVALID_STATE</a></li> <li>• <a href="#">telux::common::ErrorCode::INVALID_CALL_ID</a></li> <li>• <a href="#">telux::common::ErrorCode::INVALID_ARGUMENTS</a></li> <li>• <a href="#">telux::common::ErrorCode::OPERATION_NOT_ALLOWED</a></li> <li>• <a href="#">telux::common::ErrorCode::GENERIC_FAILURE</a></li> </ul>

**Deprecated**

This API not being supported

**Returns**

Status of success for call [reject\(\)](#) or suitable error code.

**4.4.1.1.2.6** virtual `telux::common::Status telux::tel::lCall::hangup ( std::shared_ptr< telux::common::lCommandResponseCallback > callback = nullptr ) [pure virtual]`

Hangup the call if the call state is either active, hold, dialing, waiting or alerting.

On platforms with Access control enabled, Caller needs to have TELUX\_TEL\_CALL\_MGMT permission to invoke this API successfully.

**Parameters**

in	<i>callback</i>	- optional callback pointer to get the response of hangup request below are possible error codes for callback response <ul style="list-style-type: none"> <li>• <a href="#">telux::common::ErrorCode::SUCCESS</a></li> <li>• <a href="#">telux::common::ErrorCode::RADIO_NOT_AVAILABLE</a></li> <li>• <a href="#">telux::common::ErrorCode::NO_MEMORY</a></li> <li>• <a href="#">telux::common::ErrorCode::MODEM_ERR</a></li> <li>• <a href="#">telux::common::ErrorCode::INTERNAL_ERR</a></li> <li>• <a href="#">telux::common::ErrorCode::INVALID_STATE</a></li> <li>• <a href="#">telux::common::ErrorCode::INVALID_CALL_ID</a></li> <li>• <a href="#">telux::common::ErrorCode::INVALID_ARGUMENTS</a></li> <li>• <a href="#">telux::common::ErrorCode::OPERATION_NOT_ALLOWED</a></li> <li>• <a href="#">telux::common::ErrorCode::GENERIC_FAILURE</a></li> </ul>
----	-----------------	--

**Returns**

Status of hangup i.e. success or suitable error code.

**4.4.1.1.2.7 virtual telux::common::Status telux::tel::lCall::playDtmfTone ( char *tone*, std::shared\_ptr< telux::common::lCommandResponseCallback > *callback* = nullptr ) [pure virtual]**

Play a DTMF tone and stop it. The interval for which the tone is played is dependent on the system implementation. If continuous DTMF tone is playing, it will be stopped. This API is used to play DTMF tone on TX path so that it is heard on far end. For DTMF playback on local device on the RX path use [telux::audio::IAudioVoiceStream::playDtmfTone](#)

On platforms with Access control enabled, Caller needs to have TELUX\_TEL\_CALL\_MGMT permission to invoke this API successfully.

**Parameters**

in	<i>tone</i>	- a single character with one of 12 values: 0-9, *, #.
in	<i>callback</i>	- Optional callback pointer to get the result of playDtmfTones function

**Returns**

Status of playDtmfTones i.e. success or suitable error code.

**4.4.1.1.2.8 virtual telux::common::Status telux::tel::lCall::startDtmfTone ( char *tone*, std::shared\_ptr< telux::common::lCommandResponseCallback > *callback* = nullptr ) [pure virtual]**

Starts a continuous DTMF tone. To terminate the continuous DTMF tone, stopDtmfTone API needs to be invoked explicitly. This API is used to play DTMF tone on TX path so that it is heard on far end. For DTMF playback on local device on the RX path use [telux::audio::IAudioVoiceStream::playDtmfTone](#)

On platforms with Access control enabled, Caller needs to have TELUX\_TEL\_CALL\_MGMT permission to invoke this API successfully.

**Parameters**

in	<i>tone</i>	- a single character with one of 12 values: 0-9, *, #.
in	<i>callback</i>	- Optional callback pointer to get the result of startDtmfTone function.

**Returns**

Status of startDtmfTone i.e. success or suitable error code.

**4.4.1.1.2.9 virtual telux::common::Status telux::tel::ICall::stopDtmfTone ( std::shared\_ptr< telux::common::ICommandResponseCallback > callback = nullptr ) [pure virtual]**

Stop the currently playing continuous DTMF tone.

On platforms with Access control enabled, Caller needs to have TELUX\_TEL\_CALL\_MGMT permission to invoke this API successfully.

#### Parameters

in	<i>callback</i>	- Optional callback pointer to get the result of stopDtmfTone function.
----	-----------------	---

#### Returns

Status of stopDtmfTone i.e. success or suitable error code.

**4.4.1.1.2.10 virtual CallState telux::tel::ICall::getCallState ( ) [pure virtual]**

Get the current state of the call, such as ringing, in progress etc.

On platforms with Access control enabled, Caller needs to have TELUX\_TEL\_CALL\_INFO\_READ permission to invoke this API successfully.

#### Returns

CallState - enumeration representing call State

**4.4.1.1.2.11 virtual int telux::tel::ICall::getCallIndex ( ) [pure virtual]**

Get the unique index of the call assigned by Telephony subsystem

On platforms with Access control enabled, Caller needs to have TELUX\_TEL\_CALL\_MGMT permission to invoke this API successfully.

#### Returns

Call Index

**4.4.1.1.2.12 virtual CallDirection telux::tel::ICall::getCallDirection ( ) [pure virtual]**

Get the direction of the call

On platforms with Access control enabled, Caller needs to have TELUX\_TEL\_CALL\_MGMT permission to invoke this API successfully.

#### Returns

CallDirection - enumeration representing call direction i.e. INCOMING/ OUTGOING

**4.4.1.1.2.13 virtual std::string telux::tel::ICall::getRemotePartyNumber ( ) [pure virtual]**

Get the dialing number

On platforms with Access control enabled, Caller needs to have TELUX\_TEL\_CALL\_PRIVATE\_INFO permission to invoke this API successfully.

**Returns**

Phone Number to which the call was dialed out. Empty string in case of INCOMING call direction.

**4.4.1.1.2.14 virtual CallEndCause telux::tel::ICall::getCallEndCause ( ) [pure virtual]**

Get the cause of the termination of the call.

On platforms with Access control enabled, Caller needs to have TELUX\_TEL\_CALL\_INFO\_READ permission to invoke this API successfully.

**Returns**

Enum representing call end cause.

**4.4.1.1.2.15 virtual int telux::tel::ICall::getPhoneId ( ) [pure virtual]**

Get id of the phone object which represents the network/SIM on which the call is in progress.

On platforms with Access control enabled, Caller needs to have TELUX\_TEL\_CALL\_INFO\_READ permission to invoke this API successfully.

**Returns**

Phone Id.

**4.4.1.1.2.16 virtual bool telux::tel::ICall::isMultiPartyCall ( ) [pure virtual]**

To check if call is in multi party call(conference) or not

On platforms with Access control enabled, Caller needs to have TELUX\_TEL\_CALL\_INFO\_READ permission to invoke this API successfully.

**Returns**

True if call is in conference otherwise false.

**4.4.1.2 class telux::tel::ICallListener**

A listener class for monitoring changes in call, including call state change and ECall state change. Override the methods for the state that you wish to receive updates for.

The methods in listener can be invoked from multiple different threads. The implementation should be thread safe.

**Public member functions**

- virtual void [onIncomingCall](#) (std::shared\_ptr< [ICall](#) > call)
- virtual void [onCallInfoChange](#) (std::shared\_ptr< [ICall](#) > call)
- virtual void [onECallMsdTransmissionStatus](#) (int phoneId, [telux::common::ErrorCode](#) errorCode)
- virtual void [onECallMsdTransmissionStatus](#) (int phoneId, [telux::tel::ECallMsdTransmissionStatus](#) msdTransmissionStatus)
- virtual void [OnMsdUpdateRequest](#) (int phoneId)
- virtual void [onECallHlapTimerEvent](#) (int phoneId, [ECallHlapTimerEvents](#) timersStatus)
- virtual void [onEmergencyNetworkScanFail](#) (int phoneId)
- virtual void [onEcbmChange](#) ([telux::tel::EcbMode](#) mode)
- virtual void [onRingbackTone](#) (bool isAlerting, int phoneId)
- virtual [~ICallListener](#) ()

**4.4.1.2.1 Constructors and Destructors**

**4.4.1.2.1.1** virtual [telux::tel::ICallListener::~~ICallListener](#) ( ) [[virtual](#)]

**4.4.1.2.2 Member Function Documentation**

**4.4.1.2.2.1** virtual void [telux::tel::ICallListener::onIncomingCall](#) ( std::shared\_ptr< [ICall](#) > *call* ) [[virtual](#)]

This function is called when device receives an incoming/waiting call.

On platforms with Access control enabled, Caller needs to have TELUX\_TEL\_CALL\_INFO\_READ permission to receive this notification.

**Parameters**

in	<i>call</i>	- Pointer to <a href="#">ICall</a> instance
----	-------------	---

**4.4.1.2.2.2** virtual void [telux::tel::ICallListener::onCallInfoChange](#) ( std::shared\_ptr< [ICall](#) > *call* ) [[virtual](#)]

This function is called when there is a change in call attributes

On platforms with Access control enabled, Caller needs to have TELUX\_TEL\_CALL\_INFO\_READ permission to receive this notification.

**Parameters**

in	<i>call</i>	- Pointer to <a href="#">ICall</a> instance
----	-------------	---



#### 4.4.1.2.2.3 virtual void telux::tel::ICallListener::onECallMsdTransmissionStatus ( int *phoneId*, telux::common::ErrorCode *errorCode* ) [virtual]

This function is called when device completes MSD Transmission.

On platforms with Access control enabled, Caller needs to have TELUX\_TEL\_ECALL\_MGMT permission to receive this notification.

##### Parameters

in	<i>phoneId</i>	- Unique Id of phone on which MSD Transmission Status is being reported
in	<i>errorCode</i>	- Indicates MSD Transmission status i.e. success or failure

##### Deprecated

Use another [onECallMsdTransmissionStatus\(\)](#) API with argument [ECallMsdTransmissionStatus](#)

#### 4.4.1.2.2.4 virtual void telux::tel::ICallListener::onECallMsdTransmissionStatus ( int *phoneId*, telux::tel::ECallMsdTransmissionStatus *msdTransmissionStatus* ) [virtual]

This function is called when there is Minimum Set of Data (MSD) transmission. The MSD transmission happens at call connect and also when the modem or client responds to MSD pull request from PSAP.

On platforms with Access control enabled, Caller needs to have TELUX\_TEL\_ECALL\_MGMT permission to receive this notification.

##### Parameters

in	<i>phoneId</i>	- Unique Id of phone on which MSD Transmission Status is being reported
in	<i>msdTransmission↔ Status</i>	- Indicates MSD Transmission status <a href="#">ECallMsdTransmissionStatus</a>

#### 4.4.1.2.2.5 virtual void telux::tel::ICallListener::OnMsdUpdateRequest ( int *phoneId* ) [virtual]

This function is called when MSD update is requested by PSAP.

Client is expected to update the MSD using [telux::tel::ICallManager::updateECallMsd](#) upon receiving this notification. Modem updates its internal cache and responds to PSAP with the new MSD. In situations, where the client fails to update the MSD, modem will time out and send the outdated MSD from its cache.

On platforms with Access control enabled, Caller needs to have TELUX\_TEL\_ECALL\_MGMT permission to receive this notification.

##### Parameters

in	<i>phoneId</i>	- Unique Id of phone on which MSD update request is received.
----	----------------	---

#### 4.4.1.2.2.6 virtual void telux::tel::ICallListener::onECallHlapTimerEvent ( int *phoneId*, ECallHlap↔ TimerEvents *timersStatus* ) [virtual]

This function is called when the eCall High Level Application Protocol(HLAP) timers status is changed.

On platforms with Access control enabled, Caller needs to have TELUX\_TEL\_ECALL\_MGMT permission to receive this notification.

##### Parameters

in	<i>phoneId</i>	- Unique Id of phone on which HLAP timer status is being reported
in	<i>timersStatus</i>	- Indicates the HLAP timer event <a href="#">ECallHlapTimerEvents</a>

#### 4.4.1.2.2.7 virtual void telux::tel::ICallListener::onEmergencyNetworkScanFail ( int *phoneId* ) [virtual]

This function is called whenever there is a scan failure after one round of network scan during origination of emergency call or at any time during the emergency call.

During origination of an ecall or in between an ongoing ecall, if the UE is in an area of no/poor coverage and loses service, the modem will perform network scan and try to register on any available network. If the scan completes successfully and the device finds a suitable cell, the ecall will be placed and the call state changes to the active state. If the network scan fails then this function will be invoked after one round of network scan.

On platforms with Access control enabled, Caller needs to have TELUX\_TEL\_ECALL\_MGMT permission to receive this notification.

##### Parameters

in	<i>phoneId</i>	- Unique Id of phone on which network scan failure reported.
----	----------------	--

#### 4.4.1.2.2.8 virtual void telux::tel::ICallListener::onEcbmChange ( telux::tel::EcbMode *mode* ) [virtual]

This function is called whenever emergency callback mode(ECBM) changes.

##### Parameters

in	<i>mode</i>	- Indicates the status of the ECBM. <a href="#">EcbMode</a>
----	-------------	---

#### 4.4.1.2.2.9 virtual void telux::tel::ICallListener::onRingbackTone ( bool *isAlerting*, int *phoneId* ) [virtual]

When the network doesn't play an in-band ringback tone for an alerting call, an application can play the ringback tone locally based on this notification. This function is called when the ringback tone needs to be started or stopped.

On platforms with Access control enabled, Caller needs to have TELUX\_TEL\_CALL\_INFO\_READ

permission to receive this notification.

### Parameters

in	<i>isAlerting</i>	- true to start playing ringback tone, false to stop playing ringback tone.
in	<i>phoneId</i>	- Unique Id of phone on which local ringback tone need to be triggered.

### Note

Eval: This is a new API and is being evaluated. It is subject to change and could break backward compatibility.

#### 4.4.1.3 class telux::tel::ICallManager

Call Manager is the primary interface for call related operations Allows to conference calls, swap calls, make normal voice call and emergency call, send and update MSD pdu.

#### Public member functions

- virtual [telux::common::ServiceStatus](#) [getServiceStatus](#) ()=0
- virtual [telux::common::Status](#) [makeCall](#) (int phoneId, const std::string &dialNumber, std::shared\_ptr< [IMakeCallCallback](#) > callback=nullptr)=0
- virtual [telux::common::Status](#) [makeECall](#) (int phoneId, const [ECallMsData](#) &eCallMsData, int category, int variant, std::shared\_ptr< [IMakeCallCallback](#) > callback=nullptr)=0
- virtual [telux::common::Status](#) [makeECall](#) (int phoneId, const std::string dialNumber, const [ECallMsData](#) &eCallMsData, int category, std::shared\_ptr< [IMakeCallCallback](#) > callback=nullptr)=0
- virtual [telux::common::Status](#) [makeECall](#) (int phoneId, const std::string dialNumber, const std::vector< uint8\_t > &msdPdu, [CustomSipHeader](#) header={ [telux::tel::CONTENT\\_HEADER](#), "" }, [MakeCallCallback](#) callback=nullptr)=0
- virtual [telux::common::Status](#) [makeECall](#) (int phoneId, const std::vector< uint8\_t > &msdPdu, int category, int variant, [MakeCallCallback](#) callback=nullptr)=0
- virtual [telux::common::Status](#) [makeECall](#) (int phoneId, const std::string dialNumber, const std::vector< uint8\_t > &msdPdu, int category, [MakeCallCallback](#) callback=nullptr)=0
- virtual [telux::common::Status](#) [makeECall](#) (int phoneId, int category, int variant, [MakeCallCallback](#) callback=nullptr)=0
- virtual [telux::common::Status](#) [makeECall](#) (int phoneId, const std::string dialNumber, int category, [MakeCallCallback](#) callback=nullptr)=0
- virtual [telux::common::Status](#) [updateECallMsData](#) (int phoneId, const [ECallMsData](#) &eCallMsData, std::shared\_ptr< [telux::common::ICommandResponseCallback](#) > callback=nullptr)=0
- virtual [telux::common::Status](#) [updateECallMsData](#) (int phoneId, const std::vector< uint8\_t > &msdPdu, [telux::common::ResponseCallback](#) callback)=0

- virtual `telux::common::Status requestECallHlapTimerStatus` (int phoneId, `ECallHlapTimerStatusCallback` callback)=0
- virtual `std::vector< std::shared_ptr< ICall > > getInProgressCalls` ()=0
- virtual `telux::common::Status conference` (std::shared\_ptr< `ICall` > call1, std::shared\_ptr< `ICall` > call2, std::shared\_ptr< `telux::common:: ICommandResponseCallback` > callback=nullptr)=0
- virtual `telux::common::Status swap` (std::shared\_ptr< `ICall` > callToHold, std::shared\_ptr< `ICall` > callToActivate, std::shared\_ptr< `telux::common:: ICommandResponseCallback` > callback=nullptr)=0
- virtual `telux::common::Status hangupForegroundResumeBackground` (int phoneId, `common::ResponseCallback` callback=nullptr)=0
- virtual `telux::common::Status hangupWaitingOrBackground` (int phoneId, `common::ResponseCallback` callback=nullptr)=0
- virtual `telux::common::Status requestEcbm` (int phoneId, `EcbmStatusCallback` callback)=0
- virtual `telux::common::Status exitEcbm` (int phoneId, `common::ResponseCallback` callback=nullptr)=0
- virtual `telux::common::Status requestNetworkDeregistration` (int phoneId, `common::ResponseCallback` callback=nullptr)=0
- virtual `telux::common::Status updateEcallHlapTimer` (int phoneId, `HlapTimerType` type, uint32\_t timeDuration, `common::ResponseCallback` callback=nullptr)=0
- virtual `telux::common::Status requestEcallHlapTimer` (int phoneId, `HlapTimerType` type, `ECallHlapTimerCallback` callback)=0
- virtual `telux::common::Status setECallConfig` (`EcallConfig` config)=0
- virtual `telux::common::Status getECallConfig` (`EcallConfig` &config)=0
- virtual `telux::common::Status registerListener` (std::shared\_ptr< `telux::tel::ICallListener` > listener)=0
- virtual `telux::common::Status removeListener` (std::shared\_ptr< `telux::tel::ICallListener` > listener)=0
- virtual `~ICallManager` ()

#### 4.4.1.3.1 Constructors and Destructors

4.4.1.3.1.1 virtual `telux::tel::ICallManager::~~ICallManager` ( ) [virtual]

#### 4.4.1.3.2 Member Function Documentation

#### 4.4.1.3.2.1 virtual telux::common::ServiceStatus telux::tel::ICallManager::getServiceStatus ( ) [pure virtual]

This status indicates whether the [ICallManager](#) object is in a usable state.

#### Returns

SERVICE\_AVAILABLE - If CallManager is ready for service. SERVICE\_UNAVAILABLE - If CallManager is temporarily unavailable. SERVICE\_FAILED - If CallManager encountered an irrecoverable failure.

#### 4.4.1.3.2.2 virtual telux::common::Status telux::tel::ICallManager::makeCall ( int *phoneId*, const std::string & *dialNumber*, std::shared\_ptr< IMakeCallCallback > *callback = nullptr* ) [pure virtual]

Initiate a voice call. This API can also be used for e911/e112 type of regular emergency call. This is not meant for an automotive eCall. Regular voice call will be blocked by device while eCall is in progress.

On platforms with Access control enabled, Caller needs to have TELUX\_TEL\_CALL\_MGMT permission to invoke this API successfully.

#### Parameters

in	<i>phoneId</i>	Represents phone corresponding to which on make call operation is performed
in	<i>dialNumber</i>	String representing the dialing number
in	<i>callback</i>	Optional callback pointer to get the response of makeCall request. Possible(not exhaustive) error codes for callback response <ul style="list-style-type: none"> <li>• <a href="#">telux::common::ErrorCode::SUCCESS</a></li> <li>• <a href="#">telux::common::ErrorCode::RADIO_NOT_AVAILABLE</a></li> <li>• <a href="#">telux::common::ErrorCode::DIAL_MODIFIED_TO_USSD</a></li> <li>• <a href="#">telux::common::ErrorCode::DIAL_MODIFIED_TO_SS</a></li> <li>• <a href="#">telux::common::ErrorCode::DIAL_MODIFIED_TO_DIAL</a></li> <li>• <a href="#">telux::common::ErrorCode::INVALID_ARGUMENTS</a></li> <li>• <a href="#">telux::common::ErrorCode::NO_MEMORY</a></li> <li>• <a href="#">telux::common::ErrorCode::INVALID_STATE</a></li> <li>• <a href="#">telux::common::ErrorCode::NO_RESOURCES</a></li> <li>• <a href="#">telux::common::ErrorCode::INTERNAL_ERR</a></li> <li>• <a href="#">telux::common::ErrorCode::FDN_CHECK_FAILURE</a></li> <li>• <a href="#">telux::common::ErrorCode::MODEM_ERR</a></li> <li>• <a href="#">telux::common::ErrorCode::NO_SUBSCRIPTION</a></li> <li>• <a href="#">telux::common::ErrorCode::NO_NETWORK_FOUND</a></li> <li>• <a href="#">telux::common::ErrorCode::INVALID_CALL_ID</a></li> <li>• <a href="#">telux::common::ErrorCode::DEVICE_IN_USE</a></li> <li>• <a href="#">telux::common::ErrorCode::MODE_NOT_SUPPORTED</a></li> <li>• <a href="#">telux::common::ErrorCode::ABORTED</a></li> <li>• <a href="#">telux::common::ErrorCode::GENERIC_FAILURE</a></li> </ul>

## Returns

Status of makeCall i.e. success or suitable status code.

```
4.4.1.3.2.3 virtual telux::common::Status telux::tel::ICallManager::makeECall ( int phoneId, const E↔
CallMsData & eCallMsData, int category, int variant, std::shared_ptr< IMakeCallCallback
> callback = nullptr ) [pure virtual]
```

Initiate an automotive eCall. Regular voice calls will be blocked by device while eCall is in progress.

On platforms with Access control enabled, Caller needs to have TELUX\_TEL\_ECALL\_MGMT permission to invoke this API successfully.

## Parameters

in	<i>phoneId</i>	Represents phone corresponding to which make eCall operation is performed
in	<i>eCallMsData</i>	The structure containing required fields to create eCall Minimum Set of Data (MSD)
in	<i>category</i>	<a href="#">ECallCategory</a>
in	<i>variant</i>	<a href="#">ECallVariant</a>
in	<i>callback</i>	Optional callback pointer to get the response of makeECall request. Possible(not exhaustive) error codes for callback response <ul style="list-style-type: none"> <li><a href="#">telux::common::ErrorCode::SUCCESS</a></li> <li><a href="#">telux::common::ErrorCode::RADIO_NOT_AVAILABLE</a></li> <li><a href="#">telux::common::ErrorCode::NO_MEMORY</a></li> <li><a href="#">telux::common::ErrorCode::MODEM_ERR</a></li> <li><a href="#">telux::common::ErrorCode::INTERNAL_ERR</a></li> <li><a href="#">telux::common::ErrorCode::INVALID_STATE</a></li> <li><a href="#">telux::common::ErrorCode::INVALID_CALL_ID</a></li> <li><a href="#">telux::common::ErrorCode::INVALID_ARGUMENTS</a></li> <li><a href="#">telux::common::ErrorCode::OPERATION_NOT_ALLOWED</a></li> <li><a href="#">telux::common::ErrorCode::GENERIC_FAILURE</a></li> </ul>

## Returns

Status of makeECall i.e. success or suitable status code.

```
4.4.1.3.2.4 virtual telux::common::Status telux::tel::ICallManager::makeECall ( int phoneId, const std↔
::string dialNumber, const ECallMsData & eCallMsData, int category, std::shared_ptr<
IMakeCallCallback > callback = nullptr ) [pure virtual]
```

Initiate an automotive Third Party Service(TPS) eCall over CS technologies only (i.e. not IMS) to the specified phone number with Minimum Set of Data(MSD) at call connect. It will be treated like a regular voice call by the UE and the network.

It is the responsibility of application to make sure that another call is not dialed while Third Party Service eCall is in progress.

On platforms with Access control enabled, Caller needs to have TELUX\_TEL\_ECALL\_MGMT permission to invoke this API successfully.

### Parameters

in	<i>phoneId</i>	Represents phone corresponding to which make eCall operation is performed
in	<i>dialNumber</i>	String representing the dialing number
in	<i>eCallMsdata</i>	The structure containing required fields to create eCall Minimum Set of Data (MSD)
in	<i>category</i>	<a href="#">ECallCategory</a>
in	<i>callback</i>	Optional callback pointer to get the response of makeECall request. Possible(not exhaustive) error codes for callback response <ul style="list-style-type: none"> <li>• <a href="#">telux::common::ErrorCode::SUCCESS</a></li> <li>• <a href="#">telux::common::ErrorCode::RADIO_NOT_AVAILABLE</a></li> <li>• <a href="#">telux::common::ErrorCode::NO_MEMORY</a></li> <li>• <a href="#">telux::common::ErrorCode::MODEM_ERR</a></li> <li>• <a href="#">telux::common::ErrorCode::INTERNAL_ERR</a></li> <li>• <a href="#">telux::common::ErrorCode::INVALID_STATE</a></li> <li>• <a href="#">telux::common::ErrorCode::INVALID_CALL_ID</a></li> <li>• <a href="#">telux::common::ErrorCode::INVALID_ARGUMENTS</a></li> <li>• <a href="#">telux::common::ErrorCode::OPERATION_NOT_ALLOWED</a></li> <li>• <a href="#">telux::common::ErrorCode::GENERIC_FAILURE</a></li> </ul>

### Returns

Status of makeECall i.e. success or suitable status code.

```
4.4.1.3.2.5 virtual telux::common::Status telux::tel::ICallManager::makeECall ( int phoneId, const
std::string dialNumber, const std::vector< uint8_t > & msdPdu, CustomSipHeader header
= {telux::tel::CONTENT_HEADER, ""}, MakeCallCallback callback = nullptr ) [pure
virtual]
```

Initiate an automotive Third Party Service(TPS) eCall over IMS to the specified phone number with Minimum Set of Data(MSD) at call connect. It will be treated like a regular voice call over IMS by the UE and the network.

Application is expected to dial only one Third Party Service eCall per subscription. It is the responsibility of application to make sure that another call is not dialed while Third Party Service eCall is in progress.

On platforms with Access control enabled, Caller needs to have TELUX\_TEL\_ECALL\_MGMT permission to invoke this API successfully.

### Parameters

in	<i>phoneId</i>	Represents phone corresponding to which make eCall operation is performed
----	----------------	---

in	<i>dialNumber</i>	String representing the dialing number
in	<i>msdPdu</i>	Encoded MSD(Minimum Set of Data) PDU as per spec EN 15722 2015 or GOST R 54620-2011/33464-2015 Max size 255 bytes
in	<i>header</i>	Optional SIP headers intended to be sent in the SIP invite message to the network for PSAP <ul style="list-style-type: none"> <li><a href="#">telux::tel::CustomSipHeader</a></li> </ul>
in	<i>callback</i>	Optional callback function to get the response of makeECall request.

## Returns

Status of makeECall i.e. success or suitable status code.

```
4.4.1.3.2.6 virtual telux::common::Status telux::tel::ICallManager::makeECall ( int phoneId, const
std::vector< uint8_t > & msdPdu, int category, int variant, MakeCallCallback callback =
nullptr ) [pure virtual]
```

Initiate an automotive eCall with raw MSD pdu. Regular voice calls will be blocked by device while eCall is in progress.

On platforms with Access control enabled, Caller needs to have TELUX\_TEL\_ECALL\_MGMT permission to invoke this API successfully.

## Parameters

in	<i>phoneId</i>	Represents phone corresponding to which on make eCall operation is performed
in	<i>msdPdu</i>	Encoded MSD(Minimum Set of Data) PDU as per spec EN 15722 2015 or GOST R 54620-2011/33464-2015
in	<i>category</i>	<a href="#">ECallCategory</a>
in	<i>variant</i>	<a href="#">ECallVariant</a>
in	<i>callback</i>	Callback function to get the response of makeECall request. Possible(not exhaustive) error codes for callback response <ul style="list-style-type: none"> <li><a href="#">telux::common::ErrorCode::SUCCESS</a></li> <li><a href="#">telux::common::ErrorCode::RADIO_NOT_AVAILABLE</a></li> <li><a href="#">telux::common::ErrorCode::NO_MEMORY</a></li> <li><a href="#">telux::common::ErrorCode::MODEM_ERR</a></li> <li><a href="#">telux::common::ErrorCode::INTERNAL_ERR</a></li> <li><a href="#">telux::common::ErrorCode::INVALID_STATE</a></li> <li><a href="#">telux::common::ErrorCode::INVALID_CALL_ID</a></li> <li><a href="#">telux::common::ErrorCode::INVALID_ARGUMENTS</a></li> <li><a href="#">telux::common::ErrorCode::OPERATION_NOT_ALLOWED</a></li> <li><a href="#">telux::common::ErrorCode::GENERIC_FAILURE</a></li> </ul>



## Returns

Status of makeECall i.e. success or suitable status code.

**4.4.1.3.2.7** `virtual telux::common::Status telux::tel::ICallManager::makeECall ( int phoneId,  
const std::string dialNumber, const std::vector< uint8_t > & msdPdu, int category,  
MakeCallCallback callback = nullptr ) [pure virtual]`

Initiate an automotive eCall with raw MSD pdu, to the specified phone number for TPS eCall over CS Technologies only (i.e. not IMS). It will be treated like a regular voice call by the UE and the network.

It is the responsibility of application to make sure that another call is not dialed while Third Party Service eCall is in progress.

On platforms with Access control enabled, Caller needs to have TELUX\_TEL\_ECALL\_MGMT permission to invoke this API successfully.

## Parameters

in	<i>phoneId</i>	Represents phone corresponding to which on make eCall operation is performed
in	<i>dialNumber</i>	String representing the dialing number
in	<i>msdPdu</i>	Encoded MSD(Minimum Set of Data) PDU as per spec EN 15722 2015 or GOST R 54620-2011/33464-2015
in	<i>category</i>	<a href="#">ECallCategory</a>
in	<i>callback</i>	Callback function to get the response of makeECall request. Possible(not exhaustive) error codes for callback response <ul style="list-style-type: none"> <li>• <a href="#">telux::common::ErrorCode::SUCCESS</a></li> <li>• <a href="#">telux::common::ErrorCode::RADIO_NOT_AVAILABLE</a></li> <li>• <a href="#">telux::common::ErrorCode::NO_MEMORY</a></li> <li>• <a href="#">telux::common::ErrorCode::MODEM_ERR</a></li> <li>• <a href="#">telux::common::ErrorCode::INTERNAL_ERR</a></li> <li>• <a href="#">telux::common::ErrorCode::INVALID_STATE</a></li> <li>• <a href="#">telux::common::ErrorCode::INVALID_CALL_ID</a></li> <li>• <a href="#">telux::common::ErrorCode::INVALID_ARGUMENTS</a></li> <li>• <a href="#">telux::common::ErrorCode::OPERATION_NOT_ALLOWED</a></li> <li>• <a href="#">telux::common::ErrorCode::GENERIC_FAILURE</a></li> </ul>

## Returns

Status of makeECall i.e. success or suitable status code.

**4.4.1.3.2.8** `virtual telux::common::Status telux::tel::ICallManager::makeECall ( int phoneId, int  
category, int variant, MakeCallCallback callback = nullptr ) [pure virtual]`

Initiate an automotive eCall without transmitting Minimum Set of Data (MSD) at call connect. Regular voice calls will be blocked by device while eCall is in progress.

On platforms with Access control enabled, Caller needs to have TELUX\_TEL\_ECALL\_MGMT

permission to invoke this API successfully.

### Parameters

in	<i>phoneId</i>	Represents phone corresponding to which make eCall operation is performed
in	<i>category</i>	<a href="#">ECallCategory</a>
in	<i>variant</i>	<a href="#">ECallVariant</a>
in	<i>callback</i>	Optional callback function to get the response of makeECall request. Possible(not exhaustive) error codes for callback response <ul style="list-style-type: none"> <li>• <a href="#">telux::common::ErrorCode::SUCCESS</a></li> <li>• <a href="#">telux::common::ErrorCode::RADIO_NOT_AVAILABLE</a></li> <li>• <a href="#">telux::common::ErrorCode::NO_MEMORY</a></li> <li>• <a href="#">telux::common::ErrorCode::MODEM_ERR</a></li> <li>• <a href="#">telux::common::ErrorCode::INTERNAL_ERR</a></li> <li>• <a href="#">telux::common::ErrorCode::INVALID_STATE</a></li> <li>• <a href="#">telux::common::ErrorCode::INVALID_CALL_ID</a></li> <li>• <a href="#">telux::common::ErrorCode::INVALID_ARGUMENTS</a></li> <li>• <a href="#">telux::common::ErrorCode::OPERATION_NOT_ALLOWED</a></li> <li>• <a href="#">telux::common::ErrorCode::GENERIC_FAILURE</a></li> </ul>

### Returns

Status of makeECall i.e. success or suitable status code.

```
4.4.1.3.2.9 virtual telux::common::Status telux::tel::ICallManager::makeECall ( int phoneId, const
std::string dialNumber, int category, MakeCallCallback callback = nullptr ) [pure
virtual]
```

Initiate an automotive eCall to the specified phone number for TPS eCall over CS technologies only (i.e. not IMS), without transmitting Minimum Set of Data(MSD) at call connect. It will be treated like a regular voice call by the UE and the network.

It is the responsibility of application to make sure that another call is not dialed while Third Party Service eCall is in progress.

On platforms with Access control enabled, Caller needs to have TELUX\_TEL\_ECALL\_MGMT permission to invoke this API successfully.

**Parameters**

in	<i>phoneId</i>	Represents phone corresponding to which make eCall operation is performed
in	<i>dialNumber</i>	String representing the dialing number
in	<i>category</i>	<a href="#">ECallCategory</a>
in	<i>callback</i>	Optional callback function to get the response of makeECall request. Possible(not exhaustive) error codes for callback response <ul style="list-style-type: none"> <li>• <a href="#">telux::common::ErrorCode::SUCCESS</a></li> <li>• <a href="#">telux::common::ErrorCode::RADIO_NOT_AVAILABLE</a></li> <li>• <a href="#">telux::common::ErrorCode::NO_MEMORY</a></li> <li>• <a href="#">telux::common::ErrorCode::MODEM_ERR</a></li> <li>• <a href="#">telux::common::ErrorCode::INTERNAL_ERR</a></li> <li>• <a href="#">telux::common::ErrorCode::INVALID_STATE</a></li> <li>• <a href="#">telux::common::ErrorCode::INVALID_CALL_ID</a></li> <li>• <a href="#">telux::common::ErrorCode::INVALID_ARGUMENTS</a></li> <li>• <a href="#">telux::common::ErrorCode::OPERATION_NOT_ALLOWED</a></li> <li>• <a href="#">telux::common::ErrorCode::GENERIC_FAILURE</a></li> </ul>

**Returns**

Status of makeECall i.e. success or suitable status code.

**4.4.1.3.2.10** `virtual telux::common::Status telux::tel::lCallManager::updateECallMsd ( int phoneId, const ECallMsdData & eCallMsd, std::shared_ptr< telux::common::lCommandResponse< Callback > callback = nullptr ) [pure virtual]`

Update the eCall MSD in modem to be sent to Public Safety Answering [Point](#) (PSAP) when requested.

On platforms with Access control enabled, Caller needs to have TELUX\_TEL\_ECALL\_MGMT permission to invoke this API successfully.

**Parameters**

in	<i>phoneId</i>	Represents phone corresponding to which updateECallMsd operation is performed
in	<i>eCallMsd</i>	The data structure represents the Minimum Set of Data (MSD)
in	<i>callback</i>	Optional callback pointer to get the response of updateECallMsd.

**Returns**

Status of updateECallMsd i.e. success or suitable error code.

**4.4.1.3.2.11** `virtual telux::common::Status telux::tel::ICallManager::updateECallMsd ( int phoneId, const std::vector< uint8_t > & msdPdu, telux::common::ResponseCallback callback ) [pure virtual]`

This API could be used to explicitly send MSD to PSAP in response to MSD pull request from the PSAP. The modem will not automatically update MSD to the Public Safety Answering Point (PSAP) [telux::tel::ICallListener::OnMsdUpdateRequest](#).

On platforms with Access control enabled, Caller needs to have TELUX\_TEL\_ECALL\_MGMT permission to invoke this API successfully.

#### Parameters

in	<i>phoneId</i>	Represents phone corresponding to which updateECallMsd operation is performed
in	<i>msdPdu</i>	Encoded MSD (Minimum Set of Data) PDU as per spec EN 15722 2015 or GOST R 54620-2011/33464-2015 For Third Party Service (TPS) eCall over IMS technology: Maximum length allowed for MSD is 255 bytes For all other types of eCall: Maximum length allowed for MSD is 140 bytes
in	<i>callback</i>	Callback function to get the response of updateECallMsd.

#### Returns

Status of updateECallMsd i.e. success or suitable error code.

**4.4.1.3.2.12** `virtual telux::common::Status telux::tel::ICallManager::requestECallHlapTimerStatus ( int phoneId, ECallHlapTimerStatusCallback callback ) [pure virtual]`

Request for status of eCall High Level Application Protocol (HLAP) timers that are maintained by the UE state machine. This does not retrieve status of timers maintained by the PSAP. The provided timers are as per EN 16062:2015 standard.

On platforms with Access control enabled, Caller needs to have TELUX\_TEL\_ECALL\_MGMT permission to invoke this API successfully.

#### Parameters

in	<i>phoneId</i>	Represents phone corresponding on which requestECallHlapTimerStatus operation is performed
in	<i>callback</i>	Callback function to get the response of requestECallHlapTimerStatus

#### Returns

Status of requestECallHlapTimerStatus i.e. success or suitable error code.

**4.4.1.3.2.13** `virtual std::vector<std::shared_ptr<ICall> > telux::tel::ICallManager::getInProgressCalls ( ) [pure virtual]`

Get in-progress calls.

On platforms with Access control enabled, Caller needs to have TELUX\_TEL\_CALL\_INFO\_READ permission to invoke this API successfully.

#### Returns

List of active calls.

**4.4.1.3.2.14** `virtual telux::common::Status telux::tel::ICallManager::conference ( std::shared_ptr< ICall > call1, std::shared_ptr< ICall > call2, std::shared_ptr< telux::common::ICommandResponseCallback > callback = nullptr ) [pure virtual]`

Merge two calls in a conference.

On platforms with Access control enabled, Caller needs to have TELUX\_TEL\_CALL\_MGMT permission to invoke this API successfully.

#### Parameters

in	<i>call1</i>	Call object to conference.
in	<i>call2</i>	Call object to conference.
in	<i>callback</i>	Optional callback pointer to get the result of conference function

#### Returns

Status of conference i.e. success or suitable error code.

**4.4.1.3.2.15** `virtual telux::common::Status telux::tel::ICallManager::swap ( std::shared_ptr< ICall > callToHold, std::shared_ptr< ICall > callToActivate, std::shared_ptr< telux::common::ICommandResponseCallback > callback = nullptr ) [pure virtual]`

Swap calls to make one active and put the another on hold.

On platforms with Access control enabled, Caller needs to have TELUX\_TEL\_CALL\_MGMT permission to invoke this API successfully.

#### Parameters

in	<i>callToHold</i>	Active call object to swap to hold state.
in	<i>callToActivate</i>	Hold call object to swap to active state.
in	<i>callback</i>	Optional callback pointer to get the result of swap function

#### Returns

Status of swap i.e. success or suitable error code.

#### 4.4.1.3.2.16 virtual telux::common::Status telux::tel::ICallManager::hangupForegroundResumeBackground ( int *phoneld*, common::ResponseCallback *callback* = nullptr ) [pure virtual]

Hangup all the foreground call(s) if any and accept the background call as the active call. The foreground call here could be active call, incoming call or multiple active calls in case of conference and background call could be held call or waiting call.

If a call(s) is active, the active call(s) will be terminated or if a call is waiting, the waiting call will be accepted and becomes active. Otherwise, if a held call is present, the held call becomes active. In case of hold and waiting calls, the hold call will still be on hold and waiting call will be accepted. In case of hold, active and waiting scenario, the hold call will still be on hold, active call will be ended and waiting call will be accepted.

On platforms with Access control enabled, Caller needs to have TELUX\_TEL\_CALL\_MGMT permission to invoke this API successfully.

#### Parameters

in	<i>phoneld</i>	- Represents phone corresponding to which this operation is performed.
in	<i>callback</i>	- optional callback pointer to get the response of hangup request below are possible error codes for callback response <ul style="list-style-type: none"> <li>• <a href="#">telux::common::ErrorCode::SUCCESS</a></li> <li>• <a href="#">telux::common::ErrorCode::RADIO_NOT_AVAILABLE</a></li> <li>• <a href="#">telux::common::ErrorCode::NO_MEMORY</a></li> <li>• <a href="#">telux::common::ErrorCode::MODEM_ERR</a></li> <li>• <a href="#">telux::common::ErrorCode::INTERNAL_ERR</a></li> <li>• <a href="#">telux::common::ErrorCode::INVALID_STATE</a></li> <li>• <a href="#">telux::common::ErrorCode::INVALID_CALL_ID</a></li> <li>• <a href="#">telux::common::ErrorCode::INVALID_ARGUMENTS</a></li> <li>• <a href="#">telux::common::ErrorCode::OPERATION_NOT_ALLOWED</a></li> <li>• <a href="#">telux::common::ErrorCode::GENERIC_FAILURE</a></li> </ul>

#### Returns

Status of hangupForegroundResumeBackground i.e. success or suitable error code.

#### 4.4.1.3.2.17 virtual telux::common::Status telux::tel::ICallManager::hangupWaitingOrBackground ( int *phoneld*, common::ResponseCallback *callback* = nullptr ) [pure virtual]

Hangup all the waiting or background call(s). The background call here could be waiting call, hold call or multiple hold calls in case of conference.

If a call(s) is hold, the hold call(s) will be terminated or if a call is waiting, the waiting call will be terminated as well. In case of hold, active and waiting scenario, the active call will still be on active, hold and waiting call will be ended.

On platforms with Access control enabled, Caller needs to have TELUX\_TEL\_CALL\_MGMT permission

to invoke this API successfully.

### Parameters

in	<i>phoneId</i>	- Represents phone corresponding to which this operation is performed.
in	<i>callback</i>	- optional callback pointer to get the response of hangup request below are possible error codes for callback response <ul style="list-style-type: none"> <li>• <a href="#">telux::common::ErrorCode::SUCCESS</a></li> <li>• <a href="#">telux::common::ErrorCode::RADIO_NOT_AVAILABLE</a></li> <li>• <a href="#">telux::common::ErrorCode::NO_MEMORY</a></li> <li>• <a href="#">telux::common::ErrorCode::MODEM_ERR</a></li> <li>• <a href="#">telux::common::ErrorCode::INTERNAL_ERR</a></li> <li>• <a href="#">telux::common::ErrorCode::INVALID_STATE</a></li> <li>• <a href="#">telux::common::ErrorCode::INVALID_CALL_ID</a></li> <li>• <a href="#">telux::common::ErrorCode::INVALID_ARGUMENTS</a></li> <li>• <a href="#">telux::common::ErrorCode::OPERATION_NOT_ALLOWED</a></li> <li>• <a href="#">telux::common::ErrorCode::GENERIC_FAILURE</a></li> </ul>

### Returns

Status of hangupWaitingOrBackground i.e. success or suitable error code.

#### 4.4.1.3.2.18 `virtual telux::common::Status telux::tel::ICallManager::requestEcbm ( int phoneId, EcbmStatusCallback callback ) [pure virtual]`

Request for emergency callback mode

### Parameters

in	<i>phoneId</i>	Represents the phone corresponding to which the emergency callback mode(ECBM) status is requested.
in	<i>callback</i>	Callback pointer to get the result of ECBM status request

### Returns

Status of requestEcbm i.e. success or suitable error code.

#### 4.4.1.3.2.19 `virtual telux::common::Status telux::tel::ICallManager::exitEcbm ( int phoneId, common::ResponseCallback callback = nullptr ) [pure virtual]`

Exit emergency callback mode.

On platforms with Access control enabled, Caller needs to have TELUX\_TEL\_EMERGENCY\_OPS permission to invoke this API successfully.

**Parameters**

in	<i>phoneId</i>	Represents the phone corresponding to which the emergency callback mode(ECBM) exit is requested.
in	<i>callback</i>	Optional callback pointer to get the result of exit ECBM request

**Returns**

Status of exitEcbm i.e. success or suitable error code.

#### 4.4.1.3.2.20 **virtual telux::common::Status telux::tel::lCallManager::requestNetworkDeregistration ( int *phoneId*, common::ResponseCallback *callback* = nullptr ) [pure virtual]**

Deregister from the network after an eCall when the modem is in eCall-only mode. This is typically done after the T9 eCall HLAP timer has expired to stop the T10 eCall HLAP timer and deregister from the serving network.

To invoke this API on platforms with access control enabled, the caller needs to have TELUX\_TEL\_ECALL\_MGMT permission.

**Parameters**

in	<i>phoneId</i>	Represents the phone corresponding to which the network deregistration will be performed.
in	<i>callback</i>	Callback function to get the response of the request. The response is sent after the operation is complete.

**Returns**

Status of requestNetworkDeregistration request, i.e., success or suitable error code.

#### 4.4.1.3.2.21 **virtual telux::common::Status telux::tel::lCallManager::updateEcallHlapTimer ( int *phoneId*, HlapTimerType *type*, uint32\_t *timeDuration*, common::ResponseCallback *callback* = nullptr ) [pure virtual]**

Set the value of an eCall HLAP timer. Only the T10 Timer is supported currently.

On platforms with Access control enabled, Caller needs to have TELUX\_TEL\_ECALL\_MGMT permission to invoke this API successfully.

**Parameters**

in	<i>phoneId</i>	Represents the phone corresponding to which the value of T10 eCall HLAP timer updated will be performed.
in	<i>type</i>	<a href="#">HlapTimerType</a>
in	<i>timeDuration</i>	Represents the time duration for the HLAP timer. T10 timer is in units of minutes, and the supported range is from 60 to 720.
in	<i>callback</i>	Callback function to get the response of the request. The response is sent after the operation is complete.



**Returns**

Status of updateEcallHlapTimer i.e., success or suitable error code.

**4.4.1.3.2.22** `virtual telux::common::Status telux::tel::lCallManager::requestEcallHlapTimer ( int phoneId, HlapTimerType type, EcallHlapTimerCallback callback ) [pure virtual]`

Get the value of an eCall Hlap timer. Only the T10 Timer is supported currently.

On platforms with Access control enabled, Caller needs to have TELUX\_TEL\_ECALL\_MGMT permission to invoke this API successfully.

**Parameters**

in	<i>phoneId</i>	Represents the phone corresponding to which the value of eCall Hlap timer query will be performed.
in	<i>type</i>	<a href="#">HlapTimerType</a>
in	<i>callback</i>	Callback function to get the response of the request. The response is sent after the operation is complete.

**Returns**

Status of requestEcallHlapTimer i.e., success or suitable error code.

**4.4.1.3.2.23** `virtual telux::common::Status telux::tel::lCallManager::setEcallConfig ( EcallConfig config ) [pure virtual]`

Set the configuration related to emergency call. The configuration is persistent and takes effect when the next emergency call is dialed.

Minimum value of [EcallConfig.t9Timer](#) value should be 3600000. If a lesser value is provided, this API will still succeed but the actual value would be set to 3600000.

On platforms with Access control enabled, Caller needs to have TELUX\_TEL\_ECALL\_MGMT permission to invoke this API successfully.

**Parameters**

in	<i>config</i>	eCall configuration to be set <a href="#">EcallConfig</a>
----	---------------	---

**Returns**

Status of setEcallConfig i.e. success or suitable error code.

**4.4.1.3.2.24** `virtual telux::common::Status telux::tel::lCallManager::getEcallConfig ( EcallConfig & config ) [pure virtual]`

Get the configuration related to emergency call.

On platforms with Access control enabled, Caller needs to have TELUX\_TEL\_ECALL\_MGMT permission to invoke this API successfully.

**Parameters**

out	<i>config</i>	Parameter to hold the fetched eCall configuration <a href="#">EcallConfig</a>
-----	---------------	---

**Returns**

Status of getECallConfig i.e. success or suitable error code.

#### 4.4.1.3.2.25 **virtual telux::common::Status telux::tel::ICallManager::registerListener ( std::shared\_ptr< telux::tel::ICallListener > listener ) [pure virtual]**

Add a listener to listen for incoming call, call info change and eCall MSD transmission status change.

**Parameters**

in	<i>listener</i>	Pointer to <a href="#">ICallListener</a> object which receives event corresponding to phone
----	-----------------	---

**Returns**

Status of registerListener i.e. success or suitable error code.

#### 4.4.1.3.2.26 **virtual telux::common::Status telux::tel::ICallManager::removeListener ( std::shared\_ptr< telux::tel::ICallListener > listener ) [pure virtual]**

Remove a previously added listener.

**Parameters**

in	<i>listener</i>	Listener to be removed.
----	-----------------	-------------------------

**Returns**

Status of removeListener i.e. success or suitable error code.

### 4.4.1.4 **class telux::tel::IMakeCallCallback**

Interface for Make Call callback object. Client needs to implement this interface to get single shot responses for commands like make call.

The methods in callback can be invoked from multiple different threads. The implementation should be thread safe.

**Public member functions**

- virtual void [makeCallResponse](#) ([telux::common::ErrorCode](#) error, std::shared\_ptr< [ICall](#) > call=nullptr)
- virtual [~IMakeCallCallback](#) ()

#### 4.4.1.4.1 Constructors and Destructors

4.4.1.4.1.1 `virtual telux::tel::IMakeCallCallback::~~IMakeCallCallback ( ) [virtual]`

#### 4.4.1.4.2 Member Function Documentation

4.4.1.4.2.1 `virtual void telux::tel::IMakeCallCallback::makeCallResponse ( telux::common::ErrorCode error, std::shared_ptr< ICall > call = nullptr ) [virtual]`

This function is called with the response to makeCall API.

##### Parameters

out	<i>error</i>	<a href="#">telux::common::ErrorCode</a>
out	<i>call</i>	Pointer to Call object or nullptr in case of failure

### 4.4.2 Enumeration Type Documentation

4.4.2.1 `enum telux::tel::CallDirection [strong]`

Defines type of call like incoming, outgoing and none.

##### Enumerator

***INCOMING***  
***OUTGOING***  
***NONE***

4.4.2.2 `enum telux::tel::CallState [strong]`

Defines the states a call can be in

##### Enumerator

***CALL\_IDLE*** idle call, default state of a newly created call object  
***CALL\_ACTIVE*** active call  
***CALL\_ON\_HOLD*** on hold call  
***CALL\_DIALING*** out going call, in dialing state and not yet connected, MO Call only  
***CALL\_INCOMING*** incoming call, not yet answered  
***CALL\_WAITING*** waiting call  
***CALL\_ALERTING*** alerting call, MO Call only  
***CALL\_ENDED*** call ended / disconnected

4.4.2.3 `enum telux::tel::CallEndCause [strong]`

Reason for the recently terminated call (either normally ended or failed)

##### Enumerator

***UNOBTAINABLE\_NUMBER*** Unassigned(unallocated) number  
***NO\_ROUTE\_TO\_DESTINATION*** No route to destination

**CHANNEL\_UNACCEPTABLE** Channel unacceptable  
**OPERATOR\_DETERMINED\_BARRING** Operator determined barring  
**NORMAL** Normal call barring  
**BUSY** User busy  
**NO\_USER\_RESPONDING** No user responding  
**NO\_ANSWER\_FROM\_USER** User alerting, no answer  
**NOT\_REACHABLE** Not reachable  
**CALL\_REJECTED** Call rejected  
**NUMBER\_CHANGED** Number changed  
**PREEMPTION** Pre-emption  
**DESTINATION\_OUT\_OF\_ORDER** Destination out of order  
**INVALID\_NUMBER\_FORMAT** Invalid number format (incomplete number)  
**FACILITY\_REJECTED** Facility rejected  
**RESP\_TO\_STATUS\_ENQUIRY** Response to STATUS ENQUIRY  
**NORMAL\_UNSPECIFIED** Normal, unspecified  
**CONGESTION** No circuit/channel available  
**NETWORK\_OUT\_OF\_ORDER** Network out of order  
**TEMPORARY\_FAILURE** Temporary failure  
**SWITCHING\_EQUIPMENT\_CONGESTION** Switching equipment congestion  
**ACCESS\_INFORMATION\_DISCARDED** Access information discarded  
**REQUESTED\_CIRCUIT\_OR\_CHANNEL\_NOT\_AVAILABLE** Requested circuit/channel not available  
**RESOURCES\_UNAVAILABLE\_OR\_UNSPECIFIED** Resource unavailable, unspecified  
**QOS\_UNAVAILABLE** Quality of service unavailable  
**REQUESTED\_FACILITY\_NOT\_SUBSCRIBED** Requested facility not subscribed  
**INCOMING\_CALLS\_BARRED\_WITHIN\_CUG** Incoming calls barred within the CUG  
**BEARER\_CAPABILITY\_NOT\_AUTHORIZED** Bearer capability not authorized  
**BEARER\_CAPABILITY\_UNAVAILABLE** Bearer capability not presently available  
**SERVICE\_OPTION\_NOT\_AVAILABLE** Service or option not available, unspecified  
**BEARER\_SERVICE\_NOT\_IMPLEMENTED** Bearer service not implemented  
**ACM\_LIMIT\_EXCEEDED** ACM equal to or greater than ACMmax  
**REQUESTED\_FACILITY\_NOT\_IMPLEMENTED** Requested facility not implemented  
**ONLY\_DIGITAL\_INFORMATION\_BEARER\_AVAILABLE** Only restricted digital information bearer capability is available  
**SERVICE\_OR\_OPTION\_NOT\_IMPLEMENTED** Service or option not implemented, unspecified  
**INVALID\_TRANSACTION\_IDENTIFIER** Invalid transaction identifier value  
**USER\_NOT\_MEMBER\_OF\_CUG** User not member of CUG  
**INCOMPATIBLE\_DESTINATION** Incompatible destination  
**INVALID\_TRANSIT\_NW\_SELECTION** Invalid transit network selection  
**SEMANTICALLY\_INCORRECT\_MESSAGE** Semantically incorrect message  
**INVALID\_MANDATORY\_INFORMATION** Invalid mandatory information  
**MESSAGE\_TYPE\_NON\_IMPLEMENTED** Message type non-existent or not implemented  
**MESSAGE\_TYPE\_NOT\_COMPATIBLE\_WITH\_PROTOCOL\_STATE** Message type not compatible with protocol state  
**INFORMATION\_ELEMENT\_NON\_EXISTENT** Information element non-existent or not implemented  
**CONDITIONAL\_IE\_ERROR** Conditional IE error  
**MESSAGE\_NOT\_COMPATIBLE\_WITH\_PROTOCOL\_STATE** Message not compatible with protocol state  
**RECOVERY\_ON\_TIMER\_EXPIRED** Recovery on timer expiry  
**PROTOCOL\_ERROR\_UNSPECIFIED** Protocol error, unspecified  
**INTERWORKING\_UNSPECIFIED** Interworking, unspecified

**CALL\_BARRED** Call barred  
**FDN\_BLOCKED** FDN blocked  
**IMSI\_UNKNOWN\_IN\_VLR** Incorrect IMSI  
**IMEI\_NOT\_ACCEPTED** IMEI not accepted  
**DIAL\_MODIFIED\_TO\_USSD** DIAL request modified to USSD  
**DIAL\_MODIFIED\_TO\_SS** DIAL request modified to SS  
**DIAL\_MODIFIED\_TO\_DIAL** DIAL request modified to DIAL with different data  
**EMERGENCY\_TEMP\_FAILURE** Emergency redial temporary failure  
**EMERGENCY\_PERM\_FAILURE** Emergency redial permanent failure  
**HO\_NOT\_FEASIBLE** Hand over not feasible  
**USER\_BUSY** User busy  
**USER\_REJECT** User reject  
**LOW\_BATTERY** Battery is low  
**BLACKLISTED\_CALL\_ID** Blacklisted caller id  
**CS\_RETRY\_REQUIRED** Retry CS call, VoLTE service can't be provided by the network or remote end  
**CDMA\_LOCKED\_UNTIL\_POWER\_CYCLE** MS is locked until next power cycle  
**CDMA\_DROP** Drop call  
**CDMA\_INTERCEPT** INTERCEPT order received, MS state idle entered  
**CDMA\_REORDER** MS has been redirected, call is cancelled  
**CDMA\_SO\_REJECT** Service option rejection  
**CDMA\_RETRY\_ORDER** Requested service is rejected, retry delay is set  
**CDMA\_ACCESS\_FAILURE** Unable to obtain access to the CDMA system  
**CDMA\_PREEMPTED** Not a preempted call  
**CDMA\_NOT\_EMERGENCY** For non-emergency number dialed during emergency callback mode  
**CDMA\_ACCESS\_BLOCKED** CDMA network access probes blocked  
**NETWORK\_UNAVAILABLE** Network unavailable  
**FEATURE\_UNAVAILABLE** Feature unavailable  
**SIP\_ERROR** SIP internal error  
**MISC** SIP miscellaneous error  
**ANSWERED\_ELSEWHERE** MT call has ended due to a release from the network because the call was answered elsewhere  
**PULL\_OUT\_OF\_SYNC** MultiEndpoint - call pull request has failed  
**CAUSE\_CALL\_PULLED** MultiEndpoint - call has been pulled from primary to secondary  
**SIP\_REDIRECTED** Request is redirected  
**SIP\_BAD\_REQUEST** Bad request  
**SIP\_FORBIDDEN** Forbidden  
**SIP\_NOT\_FOUND** Remote URI not found  
**SIP\_NOT\_SUPPORTED** Not supported  
**SIP\_REQUEST\_TIMEOUT** Request timed out  
**SIP\_TEMPORARILY\_UNAVAILABLE** Temporarily unavailable  
**SIP\_BAD\_ADDRESS** Address incomplete  
**SIP\_BUSY** User busy  
**SIP\_REQUEST\_CANCELLED** Request(call) rejected  
**SIP\_NOT\_ACCEPTABLE** Not acceptable  
**SIP\_NOT\_REACHABLE** Not reachable  
**SIP\_SERVER\_INTERNAL\_ERROR** Server internal error  
**SIP\_SERVER\_NOT\_IMPLEMENTED** Server not implemented  
**SIP\_SERVER\_BAD\_GATEWAY** Server bad gateway  
**SIP\_SERVICE\_UNAVAILABLE** Service unavailable

**SIP\_SERVER\_TIMEOUT** Server time out  
**SIP\_SERVER\_VERSION\_UNSUPPORTED** Server version not supported  
**SIP\_SERVER\_MESSAGE\_TOOLARGE** Server message is too large  
**SIP\_SERVER\_PRECONDITION\_FAILURE** Server pre-condition failure  
**SIP\_USER\_REJECTED** User(call) rejected  
**SIP\_GLOBAL\_ERROR** Global error  
**MEDIA\_INIT\_FAILED** Media resource initialization failure  
**MEDIA\_NO\_DATA** RTP timeout(no audio/video traffic in the session)  
**MEDIA\_NOT\_ACCEPTABLE** Media is not supported  
**MEDIA\_UNSPECIFIED\_ERROR** Media unspecified error  
**HOLD\_RESUME\_FAILED** Resume failed for hold call  
**HOLD\_RESUME\_CANCELED** Resume cancelled for hold call  
**HOLD\_REINVITE\_COLLISION** Reinvite collision for hold call  
**THERMAL\_EMERGENCY** Thermal emergency  
**ERROR\_UNSPECIFIED** Error unspecified

## 4.5 eCall

This section contains APIs related to emergency call management and configuration.

### 4.5.1 Data Structure Documentation

#### 4.5.1.1 class telux::tel::IEcallManager

[IEcallManager](#) allows operations related to automotive emergency call management and its related configurations.

##### Public member functions

- virtual [telux::common::ServiceStatus](#) getServiceStatus ()=0
- virtual [telux::common::Status](#) setConfig ([EcallConfig](#) config)=0
- virtual [telux::common::Status](#) getConfig ([EcallConfig](#) &config)=0
- virtual [telux::common::Status](#) registerListener (std::weak\_ptr< [IEcallListener](#) > listener)=0
- virtual [telux::common::Status](#) deregisterListener (std::weak\_ptr< [IEcallListener](#) > listener)=0
- virtual [~IEcallManager](#) ()

##### 4.5.1.1.1 Constructors and Destructors

4.5.1.1.1 virtual [telux::tel::IEcallManager::~IEcallManager](#) ( ) [virtual]

##### 4.5.1.1.2 Member Function Documentation

4.5.1.1.2.1 virtual [telux::common::ServiceStatus](#) [telux::tel::IEcallManager::getServiceStatus](#) ( )  
[pure virtual]

Checks the status of [IEcallManager](#) sub-system and returns the result.

##### Returns

the status of [IEcallManager](#) sub-system status [telux::common::ServiceStatus](#)

##### Deprecated

This API is not being supported

4.5.1.1.2.2 virtual [telux::common::Status](#) [telux::tel::IEcallManager::setConfig](#) ( [EcallConfig](#) config )  
[pure virtual]

Set the configuration related to emergency call. The configuration is persistent and takes effect when the next emergency call is dialed.

Minimum value of [EcallConfig.t9Timer](#) value should be 3600000. If a lesser value is provided, this API will still succeed but the actual value would be set to 3600000.

**Parameters**

in	<i>config</i>	eCall configuration to be set <a href="#">EcallConfig</a>
----	---------------	---

**Returns**

Status of setConfig i.e. success or suitable error code.

**Deprecated**

This API is not being supported. Use [ICallManager::setECallConfig\(\)](#) API instead.

#### 4.5.1.1.2.3 virtual telux::common::Status telux::tel::IEcallManager::getConfig ( EcallConfig & config ) [pure virtual]

Get the configuration related to emergency call.

**Parameters**

out	<i>config</i>	Parameter to hold the fetched eCall configuration <a href="#">EcallConfig</a>
-----	---------------	---

**Returns**

Status of getConfig i.e. success or suitable error code.

**Deprecated**

This API is not being supported. Use [ICallManager::getECallConfig\(\)](#) API instead.

#### 4.5.1.1.2.4 virtual telux::common::Status telux::tel::IEcallManager::registerListener ( std::weak\_ptr< IEcallListener > listener ) [pure virtual]

Register a listener for notifications from the EcallManager.

**Parameters**

in	<i>listener</i>	Pointer to <a href="#">IEcallListener</a> object that processes the notification
----	-----------------	--

**Returns**

Status of registerListener i.e. success or suitable error code.

**Deprecated**

This API is not being supported



**4.5.1.1.2.5** virtual telux::common::Status telux::tel::IEcallManager::deregisterListener ( std::weak\_ptr< IEcallListener > *listener* ) [pure virtual]

Deregister a previously registered listener.

#### Parameters

in	<i>listener</i>	Pointer to <a href="#">IEcallListener</a> object that needs to be deregistered.
----	-----------------	---

#### Returns

Status of deregisterListener i.e. success or suitable error code.

#### Deprecated

This API is not being supported

### 4.5.1.2 class telux::tel::IEcallListener

Listener class to notify service status change notifications. The listener method can be invoked from multiple different threads. Client needs to make sure that implementation is thread-safe.

#### Public member functions

- virtual [~IEcallListener](#) ()

#### 4.5.1.2.1 Constructors and Destructors

**4.5.1.2.1.1** virtual telux::tel::IEcallListener::~~IEcallListener ( ) [virtual]

Destructor of [IEcallListener](#)

## 4.6 SMS

This section contains APIs related to Sending and Receiving SMS.

### 4.6.1 Data Structure Documentation

#### 4.6.1.1 struct telux::tel::DeleteInfo

Specify delete information used for deleting message on storage.

##### Data fields

Type	Field	Description
<a href="#">DeleteType</a>	delType	Specifies the type of delete operation to be performed
<a href="#">SmsTagType</a>	tagType	1.If SMS tag type is set to <a href="#">telux::tel::SmsTagType::UNKNOWN</a> and delType is set to <a href="#">telux::tel::DeleteType::DELETE_ALL</a> then all messages on the storage would be deleted. 2.To delete all messages of a particular tag, set tagType to the particular tag like <a href="#">telux::tel::SmsTagType::MT_READ</a> and delType to <a href="#">telux::tel::DeleteType::DELETE_MESSAGES_BY_TAG</a>
uint32_t	msgIndex	To delete message at specific index, specify msgIndex and delType as <a href="#">telux::tel::DeleteType::DELETE_MSG_AT_INDEX</a>

#### 4.6.1.2 struct telux::tel::SmsMetaInfo

Provides certain attributes of an SMS message.

##### Data fields

Type	Field	Description
uint32_t	msgIndex	Message index on storage
<a href="#">SmsTagType</a>	tagType	SMS tag type

#### 4.6.1.3 struct telux::tel::MessageAttributes

Contains structure of message attributes like encoding type, number of segments, characters left in last segment.

##### Data fields

Type	Field	Description
<a href="#">SmsEncoding</a>	encoding	Data encoding type
int	numberOf↔ Segments	Number of segments
int	segmentSize	Max size of each segment
int	numberOf↔ CharsLeftIn↔ LastSegment	characters left in last segment

#### 4.6.1.4 struct telux::tel::MessagePartInfo

Structure containing information about the part of multi-part SMS such as concatenated message reference number, number of segments and segment number. During concatenation this information along with originating address helps in associating each part of the multi-part message to the corresponding multi-part message.

##### Data fields

Type	Field	Description
uint16_t	refNumber	Concatenated message reference number as per spec 3GPP TS 23.040 9.2.3.24.1. For each part of multipart message this message reference will be the same
uint8_t	numberOf↔ Segments	Number of segments
uint8_t	segment↔ Number	Segment Number

#### 4.6.1.5 class telux::tel::SmsMessage

Data structure represents an incoming SMS. This is applicable for single part message or part of the multipart message.

##### Public member functions

- [SmsMessage](#) (std::string text, std::string sender, std::string receiver, [SmsEncoding](#) encoding, std::string pdu, [PduBuffer](#) pduBuffer, std::shared\_ptr< [MessagePartInfo](#) > info)
- [SmsMessage](#) (std::string text, std::string sender, std::string receiver, [SmsEncoding](#) encoding, std::string pdu, [PduBuffer](#) pduBuffer, std::shared\_ptr< [MessagePartInfo](#) > info, bool isMetaInfoValid, [SmsMetaInfo](#) metaInfo)
- const std::string & [getText](#) () const
- const std::string & [getSender](#) () const
- const std::string & [getReceiver](#) () const
- [SmsEncoding](#) [getEncoding](#) () const
- const std::string & [getPdu](#) () const
- [PduBuffer](#) [getRawPdu](#) () const
- std::shared\_ptr< [MessagePartInfo](#) > [getMessagePartInfo](#) ()
- const std::string [toString](#) () const
- [telux::common::Status](#) [getMetaInfo](#) ([SmsMetaInfo](#) &metaInfo)

##### 4.6.1.5.1 Constructors and Destructors

**4.6.1.5.1.1** `telux::tel::SmsMessage::SmsMessage ( std::string text, std::string sender, std::string receiver, SmsEncoding encoding, std::string pdu, PduBuffer pduBuffer, std::shared_ptr< MessagePartInfo > info )`

**4.6.1.5.1.2** `telux::tel::SmsMessage::SmsMessage ( std::string text, std::string sender, std::string receiver, SmsEncoding encoding, std::string pdu, PduBuffer pduBuffer, std::shared_ptr< MessagePartInfo > info, bool isMetalInfoValid, SmsMetalInfo metalInfo )`

#### **4.6.1.5.2 Member Function Documentation**

**4.6.1.5.2.1** `const std::string& telux::tel::SmsMessage::getText ( ) const`

Get the message text for the single part message or part of the multipart message.

##### **Returns**

String containing SMS message.

**4.6.1.5.2.2** `const std::string& telux::tel::SmsMessage::getSender ( ) const`

Get the originating address (sender address).

##### **Returns**

String containing sender address.

**4.6.1.5.2.3** `const std::string& telux::tel::SmsMessage::getReceiver ( ) const`

Get the destination address (receiver address).

##### **Returns**

String containing receiver address

**4.6.1.5.2.4** `SmsEncoding telux::tel::SmsMessage::getEncoding ( ) const`

Get encoding format used for the single part message or part of the multipart message.

##### **Returns**

SMS message encoding used.

**4.6.1.5.2.5** `const std::string& telux::tel::SmsMessage::getPdu ( ) const`

Get the raw PDU for the single part message or part of the multipart message.

##### **Returns**

String containing raw PDU content.

**Deprecated**

Use API [SmsMessage::getRawPdu](#)

**4.6.1.5.2.6 PduBuffer telux::tel::SmsMessage::getRawPdu ( ) const**

Get the raw PDU buffer for the single part message or part of the multipart message.

**Returns**

Buffer containing raw PDU content.

**4.6.1.5.2.7 std::shared\_ptr<MessagePartInfo> telux::tel::SmsMessage::getMessagePartInfo ( )**

Applicable for multi-part SMS only. Get the information such as segment number, number of segments and concatenated reference number corresponding to the part of multi-part SMS.

**Returns**

If a message is single part SMS the method returns null otherwise returns message part information.

**4.6.1.5.2.8 const std::string telux::tel::SmsMessage::toString ( ) const**

Get the text related informative representation of this object.

**Returns**

String containing informative string.

**4.6.1.5.2.9 telux::common::Status telux::tel::SmsMessage::getMetaInfo ( SmsMetaInfo & metaInfo )**

Get meta information of SMS stored in storage. There is no meta information when storage type is none.

**Parameters**

out	<i>metaInfo</i>	Meta information about SMS message stored in storage.
-----	-----------------	---

**Returns**

Status of getMetaInfo i.e. success or suitable error code.

**4.6.1.6 class telux::tel::ISmsManager**

SmsManager class is the primary interface to manage SMS operations such as send and receive an SMS text and raw encoded PDU(s). This class handles single part and multi-part messages.

**Public member functions**

- virtual [telux::common::ServiceStatus getServiceStatus \(\)](#)=0
- virtual [telux::common::Status sendSms](#) (const std::string &message, const std::string &receiver←Address, std::shared\_ptr< [telux::common:: ICommandResponseCallback](#) > sentCallback=nullptr, std::shared\_ptr< [telux::common:: ICommandResponseCallback](#) > deliveryCallback=nullptr)=0
- virtual [telux::common::Status sendSms](#) (std::string message, std::string receiverAddress, bool deliveryReportNeeded=true, [SmsResponseCb](#) sentCallback=nullptr, std::string smscAddr="")=0
- virtual [telux::common::Status sendRawSms](#) (const std::vector< [PduBuffer](#) > rawPdus, [SmsResponseCb](#) sentCallback=nullptr)=0
- virtual [telux::common::Status requestSmscAddress](#) (std::shared\_ptr< [ISmscAddressCallback](#) > callback=nullptr)=0
- virtual [telux::common::Status setSmscAddress](#) (const std::string &smscAddress, [telux::common::ResponseCallback](#) callback=nullptr)=0
- virtual [telux::common::Status requestSmsMessageList](#) ([SmsTagType](#) type, [RequestSmsInfoListCb](#) callback)=0
- virtual [telux::common::Status readMessage](#) (uint32\_t messageIndex, [ReadSmsMessageCb](#) callback)=0
- virtual [telux::common::Status deleteMessage](#) ([DeleteInfo](#) info, [telux::common::ResponseCallback](#) callback=nullptr)=0
- virtual [telux::common::Status requestPreferredStorage](#) ([RequestPreferredStorageCb](#) callback)=0
- virtual [telux::common::Status setPreferredStorage](#) ([StorageType](#) storageType, [telux::common::ResponseCallback](#) callback=nullptr)=0
- virtual [telux::common::Status setTag](#) (uint32\_t msgIndex, [SmsTagType](#) tagType, [telux::common::ResponseCallback](#) callback=nullptr)=0
- virtual [telux::common::Status requestStorageDetails](#) ([RequestStorageDetailsCb](#) callback)=0
- virtual [MessageAttributes calculateMessageAttributes](#) (const std::string &message)=0
- virtual int [getPhoneId](#) ()=0
- virtual [telux::common::Status registerListener](#) (std::weak\_ptr< [ISmsListener](#) > listener)=0
- virtual [telux::common::Status removeListener](#) (std::weak\_ptr< [ISmsListener](#) > listener)=0
- virtual [~ISmsManager](#) ()

**4.6.1.6.1 Constructors and Destructors**

**4.6.1.6.1.1** virtual [telux::tel::ISmsManager::~~ISmsManager](#) ( ) [[virtual](#)]

**4.6.1.6.2 Member Function Documentation**

#### 4.6.1.6.2.1 virtual telux::common::ServiceStatus telux::tel::ISmsManager::getServiceStatus ( ) [pure virtual]

This status indicates whether the [ISmsManager](#) object is in a usable state.

#### Returns

[telux::common::ServiceStatus](#)

#### 4.6.1.6.2.2 virtual telux::common::Status telux::tel::ISmsManager::sendSms ( const std::string & message, const std::string & receiverAddress, std::shared\_ptr< telux::common::ICommandResponseCallback > sentCallback = nullptr, std::shared\_ptr< telux::common::ICommandResponseCallback > deliveryCallback = nullptr ) [pure virtual]

Send SMS to the destination address. When registered on IMS the SMS will be attempted over IMS. If sending SMS over IMS fails, an automatic retry would be attempted to send the message over CS. Only support UCS2 format, GSM 7 bit default alphabet and does not support National language shift tables.

On platforms with access control enabled, caller needs to have TELUX\_TEL\_SMS\_OPS permission to invoke this API successfully.

#### Parameters

in	<i>message</i>	Message text to be sent
in	<i>receiverAddress</i>	Receiver or destination address
in	<i>sentCallback</i>	Optional callback pointer to get the response of send SMS request.
in	<i>deliveryCallback</i>	Optional callback pointer to get message delivery status

#### Deprecated

Use API [ISmsManager::sendSms](#)(const std::string &message, const std::string &receiverAddress, bool deliveryReportNeeded = true, SmsResponseCb callback = nullptr, std::string smscAddr = "")

#### Returns

Status of sendSms i.e. success or suitable error code.

#### 4.6.1.6.2.3 virtual telux::common::Status telux::tel::ISmsManager::sendSms ( std::string message, std::string receiverAddress, bool deliveryReportNeeded = true, SmsResponseCb sentCallback = nullptr, std::string smscAddr = "" ) [pure virtual]

Send single or multipart SMS to the destination address. When registered on IMS the SMS will be attempted over IMS. If sending SMS over IMS fails, an automatic retry would be attempted to send the message over CS. Only support UCS2 format, GSM 7 bit default alphabet and does not support National language shift tables. The SMS is sent directly not stored on storage.

On platforms with access control enabled, caller needs to have TELUX\_TEL\_SMS\_OPS permission to invoke this API successfully.

**Parameters**

in	<i>message</i>	Message text to be send.
in	<i>receiverAddress</i>	Receiver or destination address
in	<i>deliveryReportNeeded</i>	Delivery status received in the listener API <a href="#">telux::tel::ISmsListener</a> if <i>deliveryReportNeeded</i> is true. Provided recipient responds to SMSC before the validity period expires. If <i>deliveryReportNeeded</i> is false delivery report will not be received.
in	<i>sentCallback</i>	Optional callback pointer to get the sent response for single part or multi-part SMS.
in	<i>smcAddr</i>	SMS is sent to SMSC address. If SMSC address is empty then pre-configured SMSC address is used.

**Returns**

Status of `sendSms` i.e. success or suitable error code.

#### 4.6.1.6.2.4 `virtual telux::common::Status telux::tel::ISmsManager::sendRawSms ( const std::vector< PduBuffer > rawPdus, SmsResponseCb sentCallback = nullptr ) [pure virtual]`

Send an SMS that is provided as a raw encoded PDU(s). When registered on IMS the SMS will be attempted over IMS. If sending SMS over IMS fails, an automatic retry would be attempted to send the message over CS. If the SMS is a multi-part message, the API expects multiple PDU to be passed to it. The SMS is sent directly not stored on storage.

On platforms with access control enabled, caller needs to have `TELUX_TEL_SMS_OPS` permission to invoke this API successfully.

**Parameters**

in	<i>rawPdus</i>	Each element in the vector represents a part of a multipart message. For single part message the vector will have single element.
in	<i>sentCallback</i>	Optional callback to get the sent response for single part or multi-part SMS.

**Returns**

Status of `sendRawSms` i.e. success or suitable error code.

#### 4.6.1.6.2.5 `virtual telux::common::Status telux::tel::ISmsManager::requestSmcAddress ( std::shared_ptr< ISmScAddressCallback > callback = nullptr ) [pure virtual]`

Request for Short Messaging Service Center (SMSC) Address. Purpose of SMSC is to store, forward, convert and deliver Short Message Service (SMS) messages.

On platforms with access control enabled, caller needs to have `TELUX_TEL_SMS_CONFIG` permission to invoke this API successfully.



**Parameters**

in	<i>callback</i>	Optional callback pointer to get the response of Smsc address request
----	-----------------	---

**Returns**

Status of getSmscAddress i.e. success or suitable error code.

**4.6.1.6.2.6 virtual telux::common::Status telux::tel::ISmsManager::setSmscAddress ( const std::string & *smscAddress*, telux::common::ResponseCallback *callback* = *nullptr* ) [pure virtual]**

Sets the Short Message Service Center(SMSC) address on the device.

On platforms with access control enabled, caller needs to have TELUX\_TEL\_SMS\_CONFIG permission to invoke this API successfully.

This will change the SMSC address for all the SMS messages sent from any app.

**Parameters**

in	<i>smscAddress</i>	SMSC address
in	<i>callback</i>	Optional callback pointer to get the response of set SMSC address

**Returns**

Status of setSmscAddress i.e. success or suitable error code.

**4.6.1.6.2.7 virtual telux::common::Status telux::tel::ISmsManager::requestSmsMessageList ( SmsTagType *type*, RequestSmsInfoListCb *callback* ) [pure virtual]**

Requests a list of message information for the messages saved in SIM storage.

On platforms with access control enabled, the caller needs to have TELUX\_TEL\_SMS\_STORAGE permission to invoke this API successfully.

**Parameters**

in	<i>type</i>	Specifies the tag type of the SMS message that should be matched when retrieving the list. Specifying <a href="#">telux::tel::SmsTagType::UNKNOWN</a> will retrieve all the messages from storage.
in	<i>callback</i>	Callback to get the response of request SMS messages info.

**Returns**

Status of requestSmsMessageList i.e. success or suitable error code.

#### 4.6.1.6.2.8 virtual telux::common::Status telux::tel::ISmsManager::readMessage ( uint32\_t *messageIndex*, ReadSmsMessageCb *callback* ) [pure virtual]

Retrieve a particular message from SIM storage matching the index.

On platforms with access control enabled, the caller needs to have TELUX\_TEL\_SMS\_STORAGE permission to invoke this API successfully.

##### Parameters

in	<i>messageIndex</i>	SMS index on storage.
in	<i>callback</i>	Callback to get the response of read SMS message from storage .

##### Returns

Status of readMessage i.e. success or suitable error code.

#### 4.6.1.6.2.9 virtual telux::common::Status telux::tel::ISmsManager::deleteMessage ( DeleteInfo *info*, telux::common::ResponseCallback *callback* = nullptr ) [pure virtual]

Delete specific SMS based on message index or delete messages on SIM storage based on [telux::tel::SmsTagType](#) or delete all messages from SIM storage.

On platforms with access control enabled, the caller needs to have TELUX\_TEL\_SMS\_STORAGE permission to invoke this API successfully.

##### Parameters

in	<i>info</i>	Specify delete information based on which messages are deleted
in	<i>callback</i>	Optional callback to get the response of delete SMS message from storage .

##### Returns

Status of deleteMessage i.e. success or suitable error code.

#### 4.6.1.6.2.10 virtual telux::common::Status telux::tel::ISmsManager::requestPreferredStorage ( RequestPreferredStorageCb *callback* ) [pure virtual]

Request preferred storage for incoming SMS.

On platforms with access control enabled, the caller needs to have TELUX\_TEL\_SMS\_CONFIG permission to invoke this API successfully.

##### Parameters

in	<i>callback</i>	Callback to get the response of get preferred storage type .
----	-----------------	--

**Returns**

Status of requestPreferredStorage i.e. success or suitable error code.

**4.6.1.6.2.11** `virtual telux::common::Status telux::tel::ISmsManager::setPreferredStorage ( StorageType storageType, telux::common::ResponseCallback callback = nullptr ) [pure virtual]`

Set the preferred storage for incoming SMS. All future messages that arrive will be stored on the storage set in this API, if any. Messages in the current storage will not be moved to the new storage. If client does not require messages to be stored by the platform, then the storage could be set to [telux::tel::StorageType::NONE](#).

On platforms with access control enabled, the caller needs to have TELUX\_TEL\_SMS\_CONFIG permission to invoke this API successfully.

**Parameters**

in	<i>storageType</i>	<a href="#">telux::tel::StorageType</a>
in	<i>callback</i>	Optional callback to get the response of set preferred storage.

**Returns**

Status of setPreferredStorage i.e. success or suitable error code.

**4.6.1.6.2.12** `virtual telux::common::Status telux::tel::ISmsManager::setTag ( uint32_t msgIndex, SmsTagType tagType, telux::common::ResponseCallback callback = nullptr ) [pure virtual]`

Update the tag of the incoming message stored in SIM storage as read/unread

On platforms with access control enabled, the caller needs to have TELUX\_TEL\_SMS\_OPS permission to invoke this API successfully.

**Parameters**

in	<i>msgIndex</i>	Message index corresponding to message in storage for which tag needs to be updated.
in	<i>tagType</i>	<a href="#">telux::tel::SmsTagType</a> . The applicable tag types are MT_READ and MT_NOT_READ.
in	<i>callback</i>	Optional callback to get the response of updating the tag.

**Returns**

Status of setTag i.e. success or suitable error code.

#### 4.6.1.6.2.13 virtual telux::common::Status telux::tel::ISmsManager::requestStorageDetails ( RequestStorageDetailsCb *callback* ) [pure virtual]

Request details about SIM storage like total size and available size in terms of number of messages.

On platforms with access control enabled, the caller needs to have TELUX\_TEL\_SMS\_CONFIG permission to invoke this API successfully.

##### Parameters

in	<i>callback</i>	Callback to get the response of storage detail request.
----	-----------------	---

##### Returns

Status of requestStorageDetails i.e. success or suitable error code.

#### 4.6.1.6.2.14 virtual MessageAttributes telux::tel::ISmsManager::calculateMessageAttributes ( const std::string & *message* ) [pure virtual]

Calculate message attributes for the given message.

##### Parameters

in	<i>message</i>	Message to send
----	----------------	-----------------

##### Returns

[MessageAttributes](#) structure containing encoding type, number of segments, max size of segment and characters left in last segment.

#### 4.6.1.6.2.15 virtual int telux::tel::ISmsManager::getPhoneId ( ) [pure virtual]

Get associated phone id for this SMSManager.

##### Returns

PhoneId.

#### 4.6.1.6.2.16 virtual telux::common::Status telux::tel::ISmsManager::registerListener ( std::weak\_ptr< ISmsListener > *listener* ) [pure virtual]

Register a listener for Sms events

##### Parameters

in	<i>listener</i>	Pointer to <a href="#">ISmsListener</a> object which receives event corresponding to SMS
----	-----------------	--

**Returns**

Status of registerListener i.e. success or suitable error code.

#### 4.6.1.6.2.17 virtual telux::common::Status telux::tel::ISmsManager::removeListener ( std::weak\_ptr< ISmsListener > *listener* ) [pure virtual]

Remove a previously added listener.

**Parameters**

in	<i>listener</i>	Pointer to <a href="#">ISmsListener</a> object
----	-----------------	--

**Returns**

Status of removeListener i.e. success or suitable error code.

### 4.6.1.7 class telux::tel::ISmsListener

A listener class receives notification for the incoming message(s) and delivery report for sent message(s).

The methods in listener can be invoked from multiple different threads. The implementation should be thread safe.

**Public member functions**

- virtual void [onIncomingSms](#) (int phoneId, std::shared\_ptr< [SmsMessage](#) > message)
- virtual void [onIncomingSms](#) (int phoneId, std::shared\_ptr< std::vector< [SmsMessage](#) >> messages)
- virtual void [onDeliveryReport](#) (int phoneId, int msgRef, std::string receiverAddress, [telux::common::ErrorCode](#) error)
- virtual void [onMemoryFull](#) (int phoneId, [StorageType](#) type)
- virtual [~ISmsListener](#) ()

#### 4.6.1.7.1 Constructors and Destructors

##### 4.6.1.7.1.1 virtual telux::tel::ISmsListener::~~ISmsListener ( ) [virtual]

#### 4.6.1.7.2 Member Function Documentation

##### 4.6.1.7.2.1 virtual void telux::tel::ISmsListener::onIncomingSms ( int *phoneId*, std::shared\_ptr< [SmsMessage](#) > *message* ) [virtual]

This function will be invoked when a single part message is received or when a part of a multi-part message is received. If the SMS preferred storage is to store the SMS in storage i.e SIM then the SMS will be first stored in storage and then this API will be invoked.

On platforms with access control enabled, the client needs to have TELUX\_TEL\_SMS\_LISTEN permission to invoke this API successfully.

**Parameters**

in	<i>phoneId</i>	Unique identifier per SIM slot. Phone on which the message is received.
in	<i>message</i>	Pointer to <a href="#">SmsMessage</a> object

#### 4.6.1.7.2.2 `virtual void telux::tel::ISmsListener::onIncomingSms ( int phoneId, std::shared_ptr< std::vector< SmsMessage >> messages ) [virtual]`

This function will be invoked when either a single part message is received, or when all the parts of a multipart message have been received. This API is invoked only once all parts of a message are received. In case of a single part message, it will be invoked as soon as it is received. In case of multi-part, the implementation waits for all parts of the message to arrive and then invokes this API. If the SMS preferred storage is to store the SMS in storage i.e SIM then the messages will be first stored in storage and then this API will be invoked.

On platforms with access control enabled, the client needs to have `TELUX_TEL_SMS_LISTEN` permission to invoke this API successfully.

**Parameters**

in	<i>phoneId</i>	Unique identifier per SIM slot. Phone on which the message is received.
in	<i>messages</i>	Pointer to list of <a href="#">SmsMessage</a> received corresponding to single part or all parts of multipart message.

#### 4.6.1.7.2.3 `virtual void telux::tel::ISmsListener::onDeliveryReport ( int phoneId, int msgRef, std::string receiverAddress, telux::common::ErrorCode error ) [virtual]`

This function will be invoked when either a delivery report for a single part message is received or when the delivery report for part of a multi-part message is received. In order to determine delivery of all parts of the multi-part message, the client application shall compare message reference received in the delivery indications with message references received in [telux::tel::SmsResponseCb](#).

On platforms with access control enabled, the client needs to have `TELUX_TEL_SMS_OPS` permission to invoke this API successfully.

**Parameters**

in	<i>phoneId</i>	Unique identifier per SIM slot. Phone on which the message is received.
in	<i>msgRef</i>	Message reference number (as per spec 3GPP TS 23.040 9.2.2.3) for a single part message or part of multipart message.
in	<i>receiverAddress</i>	Receiver or destination address
in	<i>error</i>	<a href="#">telux::common::ErrorCode</a>

#### 4.6.1.7.2.4 virtual void telux::tel::ISmsListener::onMemoryFull ( int *phoneId*, StorageType *type* ) [virtual]

This function will be invoked when SMS storage is full.

On platforms with access control enabled, the client needs to have TELUX\_TEL\_SMS\_STORAGE permission to invoke this API successfully.

##### Parameters

in	<i>phoneId</i>	Unique identifier per SIM slot. Phone on which the message is received.
in	<i>type</i>	<a href="#">telux::tel::StorageType</a> . Applicable storage type <a href="#">StorageType::SIM</a>

#### 4.6.1.8 class telux::tel::ISmscAddressCallback

Interface for SMS callback object. Client needs to implement this interface to get single shot responses for send SMS.

The methods in callback can be invoked from multiple different threads. The implementation should be thread safe.

##### Public member functions

- virtual void [smscAddressResponse](#) (const std::string &address, [telux::common::ErrorCode](#) error)=0

##### 4.6.1.8.1 Member Function Documentation

#### 4.6.1.8.1.1 virtual void telux::tel::ISmscAddressCallback::smscAddressResponse ( const std::string &*address*, [telux::common::ErrorCode](#) *error* ) [pure virtual]

This function is called with the response to the Smsc address request.

##### Parameters

in	<i>address</i>	Smsc address
in	<i>error</i>	<a href="#">telux::common::ErrorCode</a>

## 4.6.2 Enumeration Type Documentation

### 4.6.2.1 enum telux::tel::SmsEncoding [strong]

Specifies the encoding of the SMS message.

##### Enumerator

- GSM7** GSM 7-bit default alphabet encoding
- GSM8** GSM 8-bit data encoding
- UCS2** UCS-2 encoding

**UNKNOWN** Unknown encoding

#### 4.6.2.2 enum telux::tel::SmsTagType [strong]

Specifies the SMS tag type. All incoming messages will be received and stored with tag as MT\_NOT\_READ. It is the client's responsibility to update the tag to MT\_READ using [telux::tel::ISmsManager::setTag](#) whenever the message is considered read.

##### Enumerator

**UNKNOWN** Unknown tag type

**MT\_READ** MT message marked as read

**MT\_NOT\_READ** MT message marked as not read

#### 4.6.2.3 enum telux::tel::DeleteType [strong]

Specifies the type of delete operation to be performed.

##### Enumerator

**UNKNOWN** Unknown delete type

**DELETE\_ALL** Delete all message from memory storage

**DELETE\_MESSAGES\_BY\_TAG** Deletes all messages from the memory storage that match the specific message tag

**DELETE\_MSG\_AT\_INDEX** Deletes only the message at the specific index from the memory storage

#### 4.6.2.4 enum telux::tel::StorageType [strong]

Specifies the SMS storage type for incoming message.

##### Enumerator

**UNKNOWN** Unknown storage type

**NONE** This indicates SMS not stored on any of storage and is directly notified to client. This is the default storage type

**SIM** This indicates SMS is stored on SIM



## 4.7 SIM Card Services

This section contains APIs related to Card Services.

### 4.7.1 Data Structure Documentation

#### 4.7.1.1 class telux::tel::ICardApp

Represents a single card application.

##### Public member functions

- virtual [AppType](#) `getAppType ()=0`
- virtual [AppState](#) `getAppState ()=0`
- virtual `std::string` `getAppId ()=0`
- virtual [telux::common::Status](#) `changeCardPassword (CardLockType lockType, std::string oldPwd, std::string newPwd, PinOperationResponseCb callback)=0`
- virtual [telux::common::Status](#) `unlockCardByPuk (CardLockType lockType, std::string puk, std::string newPin, PinOperationResponseCb callback)=0`
- virtual [telux::common::Status](#) `unlockCardByPin (CardLockType lockType, std::string pin, PinOperationResponseCb callback)=0`
- virtual [telux::common::Status](#) `queryPin1LockState (QueryPin1LockResponseCb callback)=0`
- virtual [telux::common::Status](#) `queryFdnLockState (QueryFdnLockResponseCb callback)=0`
- virtual [telux::common::Status](#) `setCardLock (CardLockType lockType, std::string password, bool isEnabled, PinOperationResponseCb callback)=0`
- virtual `~ICardApp ()`

##### 4.7.1.1.1 Constructors and Destructors

4.7.1.1.1.1 virtual `telux::tel::ICardApp::~~ICardApp ( ) [virtual]`

##### 4.7.1.1.2 Member Function Documentation

4.7.1.1.2.1 virtual `AppType` `telux::tel::ICardApp::getAppType ( ) [pure virtual]`

Get Application type like SIM, USIM, RUIM, CSIM or ISIM.

##### Returns

[AppType](#).

**4.7.1.1.2.2 virtual AppState telux::tel::ICardApp::getAppState ( ) [pure virtual]**

Get Application state like PIN1, PUK required and others.

**Returns**

[AppState](#).

**4.7.1.1.2.3 virtual std::string telux::tel::ICardApp::getAppld ( ) [pure virtual]**

Get application identifier.

**Returns**

Application Id.

**4.7.1.1.2.4 virtual telux::common::Status telux::tel::ICardApp::changeCardPassword ( CardLockType lockType, std::string oldPwd, std::string newPwd, PinOperationResponseCb callback ) [pure virtual]**

Change the password used in PIN1/PIN2 lock.

On platforms with access control enabled, caller needs to have TELUX\_TEL\_CARD\_PRIVILEGED\_OPS permission to invoke this API successfully.

**Parameters**

in	<i>lockType</i>	<a href="#">CardLockType</a> . Applicable lock types are PIN1 and PIN2.
in	<i>oldPwd</i>	Old password
in	<i>newPwd</i>	New password
in	<i>callback</i>	Callback function to get the response of change pin password.

**4.7.1.1.2.5 virtual telux::common::Status telux::tel::ICardApp::unlockCardByPuk ( CardLockType lockType, std::string puk, std::string newPin, PinOperationResponseCb callback ) [pure virtual]**

Unlock the Sim card for an app by entering PUK and new pin.

On platforms with access control enabled, caller needs to have TELUX\_TEL\_CARD\_PRIVILEGED\_OPS permission to invoke this API successfully.

**Parameters**

in	<i>lockType</i>	<a href="#">CardLockType</a> . Applicable lock types are PUK1 and PUK2
in	<i>puk</i>	PUK1/PUK2
in	<i>newPin</i>	New PIN1/PIN2
in	<i>callback</i>	Callback function to get the response of unlock card lock.

#### 4.7.1.1.2.6 virtual telux::common::Status telux::tel::ICardApp::unlockCardByPin ( CardLockType lockType, std::string pin, PinOperationResponseCb callback ) [pure virtual]

Unlock the Sim card for an app by entering PIN.

On platforms with access control enabled, caller needs to have TELUX\_TEL\_CARD\_PRIVILEGED\_OPS permission to invoke this API successfully.

##### Parameters

in	<i>lockType</i>	<a href="#">CardLockType</a> . Applicable lock types are PIN1 and PIN2.
in	<i>pin</i>	New PIN1/PIN2
in	<i>callback</i>	Callback function to get the response of unlock card lock.

#### 4.7.1.1.2.7 virtual telux::common::Status telux::tel::ICardApp::queryPin1LockState ( QueryPin1LockResponseCb callback ) [pure virtual]

Query Pin1 lock state.

On platforms with access control enabled, caller needs to have TELUX\_TEL\_CARD\_OPS permission to invoke this API successfully.

##### Parameters

in	<i>callback</i>	Callback function to get the response of query pin1 lock state.
----	-----------------	---

#### 4.7.1.1.2.8 virtual telux::common::Status telux::tel::ICardApp::queryFdnLockState ( QueryFdnLockResponseCb callback ) [pure virtual]

Query FDN lock state.

On platforms with access control enabled, caller needs to have TELUX\_TEL\_CARD\_OPS permission to invoke this API successfully.

##### Parameters

in	<i>callback</i>	Callback function to get the response of query fdn lock state.
----	-----------------	--

#### 4.7.1.1.2.9 virtual telux::common::Status telux::tel::ICardApp::setCardLock ( CardLockType lockType, std::string password, bool isEnabled, PinOperationResponseCb callback ) [pure virtual]

Enable or disable FDN or Pin1 lock.

On platforms with access control enabled, caller needs to have TELUX\_TEL\_CARD\_PRIVILEGED\_OPS permission to invoke this API successfully.

**Parameters**

in	<i>lockType</i>	<a href="#">CardLockType</a> . Applicable lock type such as PIN1 and FDN
in	<i>password</i>	Password of PIN1 and FDN
in	<i>isEnabled</i>	If true then enable else disable.
in	<i>callback</i>	Callback function to get the response of set card lock.

**4.7.1.2 struct telux::tel::lccResult**

The APDU response with status for transmit APDU operation.

**Public member functions**

- const std::string [toString](#) () const

**Data Fields**

- int [sw1](#)
- int [sw2](#)
- std::string [payload](#)
- std::vector< int > [data](#)

**4.7.1.2.1 Member Function Documentation**

**4.7.1.2.1.1** const std::string telux::tel::lccResult::toString ( ) const

**4.7.1.2.2 Field Documentation**

**4.7.1.2.2.1** int telux::tel::lccResult::sw1

Status word 1 for command processing status

**4.7.1.2.2.2** int telux::tel::lccResult::sw2

Status word 2 for command processing qualifier

**4.7.1.2.2.3** std::string telux::tel::lccResult::payload

response as a hex string

**4.7.1.2.2.4** std::vector<int> telux::tel::lccResult::data

vector of raw data received as part of response to the card services request

### 4.7.1.3 struct telux::tel::FileAttributes

SIM Elementary file attributes.

#### Data fields

Type	Field	Description
uint16_t	fileSize	File size of transparent or linear fixed file.
uint16_t	recordSize	Size of the file record. Applicable only for <a href="#">telux::tel::EfType::LINEAR_FIXED</a> .
uint16_t	recordCount	The number of records in a file. Applicable only for <a href="#">telux::tel::EfType::LINEAR_FIXED</a> .

### 4.7.1.4 class telux::tel::ICardFileHandler

[ICardFileHandler](#) provides APIs for reading from an elementary file(EF) on SIM and writing to EF on SIM. Provide API to get EF attributes like file size, record size, and the number of records in EF.

#### Public member functions

- virtual [telux::common::Status readEFLinearFixed](#) (std::string filePath, uint16\_t fileId, int recordNum, std::string aid, [EfOperationCallback](#) callback)=0
- virtual [telux::common::Status readEFLinearFixedAll](#) (std::string filePath, uint16\_t fileId, std::string aid, [EfReadAllRecordsCallback](#) callback)=0
- virtual [telux::common::Status readEFTransparent](#) (std::string filePath, uint16\_t fileId, int size, std::string aid, [EfOperationCallback](#) callback)=0
- virtual [telux::common::Status writeEFLinearFixed](#) (std::string filePath, uint16\_t fileId, int recordNum, std::vector< uint8\_t > data, std::string pin2, std::string aid, [EfOperationCallback](#) callback)=0
- virtual [telux::common::Status writeEFTransparent](#) (std::string filePath, uint16\_t fileId, std::vector< uint8\_t > data, std::string aid, [EfOperationCallback](#) callback)=0
- virtual [telux::common::Status requestEFAttributes](#) ([EfType](#) efType, std::string filePath, uint16\_t fileId, std::string aid, [EfGetFileAttributesCallback](#) callback)=0
- virtual SlotId [getSlotId](#) ()=0

#### 4.7.1.4.1 Member Function Documentation

**4.7.1.4.1.1** virtual [telux::common::Status telux::tel::ICardFileHandler::readEFLinearFixed](#) ( [std::string filePath](#), [uint16\\_t fileId](#), [int recordNum](#), [std::string aid](#), [EfOperationCallback callback](#) )  
[pure virtual]

Read a record from a SIM linear fixed elementary file (EF).

**Parameters**

in	<i>filePath</i>	File path of the elementary file to be read Refer ETSI GTS GSM 11.11 V5.3.0 6.5. For example to read EF FDN corresponding to USIM app the file path is "3F007FFF"
in	<i>fileId</i>	Elementary file identifier. For example File Id for EF FDN is 0x6F3B
in	<i>recordNum</i>	Record number is 1-based (not 0-based)
in	<i>aid</i>	Application identifier is optional for reading EF that is not part of card application
in	<i>callback</i>	Callback function to get the response of readEFLinearFixed request

**Returns**

- Status of readEFLinearFixed i.e. success or suitable status code

**4.7.1.4.1.2** `virtual telux::common::Status telux::tel::ICardFileHandler::readEFLinearFixedAll ( std::string filePath, uint16_t fileId, std::string aid, EfReadAllRecordsCallback callback ) [pure virtual]`

Read all records from a SIM linear fixed elementary file (EF).

**Parameters**

in	<i>filePath</i>	File path of the elementary file to be read Refer ETSI GTS GSM 11.11 V5.3.0 6.5. For example to read EF FDN corresponding to USIM app the file path is "3F007FFF"
in	<i>fileId</i>	Elementary file identifier. For example File Id for EF FDN is 0x6F3B
in	<i>aid</i>	Application identifier is optional for reading EF that is not part of card application
in	<i>callback</i>	Callback function to get the response of readEFLinearFixedAll request

**Returns**

- Status of readEFLinearFixedAll i.e. success or suitable status code

**4.7.1.4.1.3** `virtual telux::common::Status telux::tel::ICardFileHandler::readEFTransparent ( std::string filePath, uint16_t fileId, int size, std::string aid, EfOperationCallback callback ) [pure virtual]`

Read from a SIM transparent elementary file (EF).

**Parameters**

in	<i>filePath</i>	File path of the elementary file to be read Refer ETSI GTS GSM 11.11 V5.3.0 6.5. For example to read EF ICCID the file path is "3F00"
in	<i>fileId</i>	Elementary file identifier. For example File Id for EF ICCID is 0x2FE2
in	<i>size</i>	If the size is zero then read the complete file otherwise, read the first size bytes from EF.
in	<i>aid</i>	Application identifier is optional for reading EF that is not part of card application
in	<i>callback</i>	Callback function to get the response of readEFTransparent request

**Returns**

- Status of readEFTransparent i.e. success or suitable status code

**4.7.1.4.1.4** `virtual telux::common::Status telux::tel::ICardFileHandler::writeEFLinearFixed ( std::string filePath, uint16_t fileId, int recordNum, std::vector< uint8_t > data, std::string pin2, std::string aid, EfOperationCallback callback ) [pure virtual]`

Write a record in a SIM linear fixed elementary file (EF).

**Parameters**

in	<i>filePath</i>	File path of the elementary file to be written. Refer ETSI GTS GSM 11.11 V5.3.0 6.5. For example to update record to EF FDN corresponding to USIM app the file path is "3F007FFF"
in	<i>fileId</i>	Elementary file identifier. For example File Id for EF FDN is 0x6F3B
in	<i>recordNum</i>	Record number is 1-based (not 0-based)
in	<i>data</i>	Data represents record in the EF
in	<i>pin2</i>	Pin2 for card holder verification(CHV2) operations, otherwise must be empty.
in	<i>aid</i>	Application identifier is optional for writing to EF that is not part of card application.
in	<i>callback</i>	Callback function to get the response of writeEFLinearFixed request

**Returns**

- Status of writeEFLinearFixed i.e. success or suitable status code

**4.7.1.4.1.5** `virtual telux::common::Status telux::tel::ICardFileHandler::writeEFTransparent ( std::string filePath, uint16_t fileId, std::vector< uint8_t > data, std::string aid, EfOperationCallback callback ) [pure virtual]`

Write in a SIM transparent elementary file (EF).

**Parameters**

in	<i>filePath</i>	File path of the elementary file to be written Refer ETSI GTS GSM 11.11 V5.3.0 6.5. For example to write to EF ICCID the file path is "3F00"
in	<i>fileId</i>	Elementary file identifier. For example File Id for EF ICCID is 0x2FE2
in	<i>data</i>	Binary data to be written on the EF
in	<i>aid</i>	Application identifier is optional for writing to EF that is not part of card application.
in	<i>callback</i>	Callback function to get the response of writeEFTransparent request

**Returns**

- Status of writeEFTransparent i.e. success or suitable status code

**4.7.1.4.1.6** virtual telux::common::Status telux::tel::ICardFileHandler::requestEFAttributes ( EfType efType, std::string filePath, uint16\_t fileId, std::string aid, EfGetFileAttributesCallback callback ) [pure virtual]

Get file attributes for SIM elementary file(EF).

**Parameters**

in	<i>efType</i>	Elementary file type i.e. <a href="#">telux::tel::EfType</a>
in	<i>filePath</i>	File path of the elementary file to read file attributes Refer ETSI GTS GSM 11.11 V5.3.0 6.5. For example to read file attributes of EF ICCID the file path is "3F00"
in	<i>fileId</i>	Elementary file identifier. For example File Id for EF ICCID is 0x2FE2
in	<i>aid</i>	Application identifier is optional for EF that is not part of card application.
in	<i>callback</i>	Callback function to get the response of requestEFAttributes request

**Returns**

- Status of requestEFAttributes i.e. success or suitable status code

**4.7.1.4.1.7** virtual SlotId telux::tel::ICardFileHandler::getSlotId ( ) [pure virtual]

Get associated slot identifier for [ICardFileHandler](#)

**Returns**

telux::common::SlotId



### 4.7.1.5 class telux::tel::ICardManager

[ICardManager](#) provide APIs for slot count, retrieve slot ids, get card state and get card.

#### Public member functions

- virtual bool [isSubsystemReady](#) ()=0
- virtual std::future< bool > [onSubsystemReady](#) ()=0
- virtual [telux::common::ServiceStatus](#) [getServiceStatus](#) ()=0
- virtual [telux::common::Status](#) [getSlotCount](#) (int &count)=0
- virtual [telux::common::Status](#) [getSlotIds](#) (std::vector< int > &slotIds)=0
- virtual std::shared\_ptr< [ICard](#) > [getCard](#) (int slotId=DEFAULT\_SLOT\_ID, [telux::common::Status](#) \*status=nullptr)=0
- virtual [telux::common::Status](#) [cardPowerUp](#) (SlotId slotId, [telux::common::ResponseCallback](#) callback=nullptr)=0
- virtual [telux::common::Status](#) [cardPowerDown](#) (SlotId slotId, [telux::common::ResponseCallback](#) callback=nullptr)=0
- virtual [telux::common::Status](#) [registerListener](#) (std::shared\_ptr< [ICardListener](#) > listener)=0
- virtual [telux::common::Status](#) [removeListener](#) (std::shared\_ptr< [ICardListener](#) > listener)=0
- virtual [~ICardManager](#) ()

#### 4.7.1.5.1 Constructors and Destructors

4.7.1.5.1.1 virtual [telux::tel::ICardManager::~ICardManager](#) ( ) [[virtual](#)]

#### 4.7.1.5.2 Member Function Documentation

4.7.1.5.2.1 virtual bool [telux::tel::ICardManager::isSubsystemReady](#) ( ) [[pure virtual](#)]

Checks the status of telephony subsystems and returns the result.

#### Deprecated

Use [ICardManager::getServiceStatus\(\)](#) API.

#### Returns

If true then CardManager is ready for service.

**4.7.1.5.2.2** `virtual std::future<bool> telux::tel::ICardManager::onSubsystemReady ( ) [pure virtual]`

Wait for telephony subsystem to be ready.

#### Deprecated

Use `InitResponseCb` in `PhoneFactory::getCardManager` instead, to get notified about subsystem readiness.

#### Returns

A future that caller can wait on to be notified when card manager is ready.

**4.7.1.5.2.3** `virtual telux::common::ServiceStatus telux::tel::ICardManager::getServiceStatus ( ) [pure virtual]`

This status indicates whether the `ICardManager` object is in a usable state.

#### Returns

`SERVICE_AVAILABLE` - If Card Manager is ready for service. `SERVICE_UNAVAILABLE` - If Card Manager is temporarily unavailable. `SERVICE_FAILED` - If Card Manager encountered an irrecoverable failure.

#### Note

Eval: This is a new API and is being evaluated. It is subject to change and could break backwards compatibility.

**4.7.1.5.2.4** `virtual telux::common::Status telux::tel::ICardManager::getSlotCount ( int & count ) [pure virtual]`

Get SIM slot count.

#### Parameters

out	<i>count</i>	SIM slot count.
-----	--------------	-----------------

#### Returns

Status of `getSlotCount` i.e. success or suitable status code.

**4.7.1.5.2.5** `virtual telux::common::Status telux::tel::ICardManager::getSlotIds ( std::vector< int > & slotIds ) [pure virtual]`

Get list of SIM slots.

**Parameters**

out	<i>slotIds</i>	List of SIM slot ids.
-----	----------------	-----------------------

**Returns**

Status of getSlotIds i.e. success or suitable status code.

**4.7.1.5.2.6** virtual std::shared\_ptr<ICard> telux::tel::ICardManager::getCard ( int *slotId* = *DEFAULT\_SLOT\_ID*, telux::common::Status \* *status* = *nullptr* ) [pure virtual]

Get the Card corresponding to SIM slot.

**Parameters**

in	<i>slotId</i>	Slot id corresponding to the card.
out	<i>status</i>	Status of getCard i.e. success or suitable status code.

**Returns**

Pointer to [ICard](#) object.

**4.7.1.5.2.7** virtual telux::common::Status telux::tel::ICardManager::cardPowerUp ( SlotId *slotId*, telux::common::ResponseCallback *callback* = *nullptr* ) [pure virtual]

Power on the SIM card.

On platforms with access control enabled, caller needs to have TELUX\_TEL\_CARD\_POWER permission to invoke this API successfully.

**Parameters**

in	<i>slotId</i>	Slot identifier corresponding to the card which needs to be powered up.
in	<i>callback</i>	Optional callback pointer to get the result of cardPowerUp

**Returns**

Status of cardPowerUp i.e. success or suitable status code.

**4.7.1.5.2.8** virtual telux::common::Status telux::tel::ICardManager::cardPowerDown ( SlotId *slotId*, telux::common::ResponseCallback *callback* = *nullptr* ) [pure virtual]

Power off the SIM card. When the SIM card is powered down, the card state is absent and the SIM IO operations, PIN management API's like unlock card by pin, change card pin will fail.

On platforms with access control enabled, caller needs to have TELUX\_TEL\_CARD\_POWER permission to invoke this API successfully.

**Parameters**

in	<i>slotId</i>	Slot identifier corresponding to the card which needs to be powered down.
in	<i>callback</i>	Optional callback pointer to get the result of CardPowerDown

**Returns**

Status of cardPowerDown i.e. success or suitable status code.

#### 4.7.1.5.2.9 virtual telux::common::Status telux::tel::ICardManager::registerListener ( std::shared\_ptr< ICardListener > *listener* ) [pure virtual]

Register a listener for card events.

**Parameters**

in	<i>listener</i>	Pointer to <a href="#">ICardListener</a> object that processes the notification.
----	-----------------	--

**Returns**

Status of registerListener i.e. success or suitable status code.

#### 4.7.1.5.2.10 virtual telux::common::Status telux::tel::ICardManager::removeListener ( std::shared\_ptr< ICardListener > *listener* ) [pure virtual]

Remove a previously added listener.

**Parameters**

in	<i>listener</i>	Pointer to <a href="#">ICardListener</a> object that needs to be removed.
----	-----------------	---

**Returns**

Status of removeListener i.e. success or suitable status code.

### 4.7.1.6 class telux::tel::ICard

[ICard](#) represents currently inserted UICC or eUICC.

**Public member functions**

- virtual [telux::common::Status](#) [getState](#) ([CardState](#) &cardState)=0
- virtual std::vector< std::shared\_ptr< [ICardApp](#) > > [getApplications](#) ([telux::common::Status](#) \*status=nullptr)=0
- virtual [telux::common::Status](#) [openLogicalChannel](#) (std::string applicationId, std::shared\_ptr< [ICardChannelCallback](#) > callback=nullptr)=0

- virtual `telux::common::Status closeLogicalChannel` (int channelId, std::shared\_ptr< `telux::common:: ICommandResponseCallback` > callback=nullptr)=0
- virtual `telux::common::Status transmitApuLogicalChannel` (int channel, uint8\_t cla, uint8\_t instruction, uint8\_t p1, uint8\_t p2, uint8\_t p3, std::vector< uint8\_t > data, std::shared\_ptr< `ICardCommandCallback` > callback=nullptr)=0
- virtual `telux::common::Status transmitApuBasicChannel` (uint8\_t cla, uint8\_t instruction, uint8\_t p1, uint8\_t p2, uint8\_t p3, std::vector< uint8\_t > data, std::shared\_ptr< `ICardCommandCallback` > callback=nullptr)=0
- virtual `telux::common::Status exchangeSimIO` (uint16\_t fileId, uint8\_t command, uint8\_t p1, uint8\_t p2, uint8\_t p3, std::string filePath, std::vector< uint8\_t > data, std::string pin2, std::string aid, std::shared\_ptr< `ICardCommandCallback` > callback=nullptr)=0
- virtual int `getSlotId` ()=0
- virtual `telux::common::Status requestEid` (`EidResponseCallback` callback)=0
- virtual std::shared\_ptr< `ICardFileHandler` > `getFileHandler` ()=0

#### 4.7.1.6.1 Member Function Documentation

##### 4.7.1.6.1.1 virtual `telux::common::Status telux::tel::ICard::getState` ( `CardState & cardState` ) [pure virtual]

Get the card state for the slot id.

##### Parameters

out	<i>cardState</i>	<code>CardState</code> - state of the card.
-----	------------------	---

##### Returns

Status of `getCardState` i.e. success or suitable status code.

##### 4.7.1.6.1.2 virtual `std::vector<std::shared_ptr<ICardApp>>` `telux::tel::ICard::getApplications` ( `telux::common::Status * status = nullptr` ) [pure virtual]

Get card applications.

##### Parameters

out	<i>status</i>	Status of <code>getApplications</code> i.e. success or suitable status code.
-----	---------------	--

##### Returns

List of card applications.

**4.7.1.6.1.3** `virtual telux::common::Status telux::tel::ICard::openLogicalChannel ( std::string applicationId, std::shared_ptr< ICardChannelCallback > callback = nullptr ) [pure virtual]`

Open a logical channel to the SIM.

On platforms with access control enabled, caller needs to have TELUX\_TEL\_CARD\_OPS permission to invoke this API successfully.

#### Parameters

in	<i>applicationId</i>	Application Id.
in	<i>callback</i>	Optional callback pointer to get the response of open logical channel request.

#### Returns

Status of openLogicalChannel i.e. success or suitable status code.

**4.7.1.6.1.4** `virtual telux::common::Status telux::tel::ICard::closeLogicalChannel ( int channelId, std::shared_ptr< telux::common::ICommandResponseCallback > callback = nullptr ) [pure virtual]`

Close a previously opened logical channel to the SIM.

On platforms with access control enabled, caller needs to have TELUX\_TEL\_CARD\_OPS permission to invoke this API successfully.

#### Parameters

in	<i>channelId</i>	The channel ID to be closed.
in	<i>callback</i>	Optional callback pointer to get the response of close logical channel request.

#### Returns

Status of closeLogicalChannel i.e. success or suitable status code.

**4.7.1.6.1.5** `virtual telux::common::Status telux::tel::ICard::transmitApduLogicalChannel ( int channel, uint8_t cla, uint8_t instruction, uint8_t p1, uint8_t p2, uint8_t p3, std::vector< uint8_t > data, std::shared_ptr< ICardCommandCallback > callback = nullptr ) [pure virtual]`

Transmit an APDU to the ICC card over a logical channel.

On platforms with access control enabled, caller needs to have TELUX\_TEL\_CARD\_OPS permission to invoke this API successfully.

**Parameters**

in	<i>channel</i>	Channel Id of the channel to use for communication. Has to be greater than zero.
in	<i>cla</i>	Class of the APDU command.
in	<i>instruction</i>	Instruction of the APDU command.
in	<i>p1</i>	Instruction Parameter 1 value of the APDU command.
in	<i>p2</i>	Instruction Parameter 2 value of the APDU command.
in	<i>p3</i>	Number of bytes present in the data field of the APDU command. If p3 is negative, a 4 byte APDU is sent to the SIM.
in	<i>data</i>	Data to be sent with the APDU.
in	<i>callback</i>	Optional callback pointer to get the response of transmit APDU request.

**Returns**

Status of `transmitApduLogicalChannel` i.e. success or suitable status code.

**4.7.1.6.1.6** `virtual telux::common::Status telux::tel::ICard::transmitApduBasicChannel ( uint8_t cla, uint8_t instruction, uint8_t p1, uint8_t p2, uint8_t p3, std::vector< uint8_t > data, std::shared_ptr< ICardCommandCallback > callback = nullptr ) [pure virtual]`

Exchange APDUs with the SIM on a basic channel.

On platforms with access control enabled, caller needs to have `TELUX_TEL_CARD_OPS` permission to invoke this API successfully.

**Parameters**

in	<i>cla</i>	Class of the APDU command.
in	<i>instruction</i>	Instruction of the APDU command.
in	<i>p1</i>	Instruction Param1 value of the APDU command.
in	<i>p2</i>	Instruction Param1 value of the APDU command.
in	<i>p3</i>	Number of bytes present in the data field of the APDU command. If p3 is negative, a 4 byte APDU is sent to the SIM.
in	<i>data</i>	Data to be sent with the APDU.
in	<i>callback</i>	Optional callback pointer to get the response of transmit APDU request.

**Returns**

Status of `transmitApduBasicChannel` i.e. success or suitable status code.

**4.7.1.6.1.7** `virtual telux::common::Status telux::tel::ICard::exchangeSimIO ( uint16_t fileId, uint8_t command, uint8_t p1, uint8_t p2, uint8_t p3, std::string filePath, std::vector< uint8_t > data, std::string pin2, std::string aid, std::shared_ptr< ICardCommandCallback > callback = nullptr ) [pure virtual]`

Performs SIM IO operation, This is similar to the TS 27.007 "restricted SIM" operation where it assumes all of the EF selection will be done by the callee.

On platforms with access control enabled, caller needs to have TELUX\_TEL\_CARD\_OPS permission to invoke this API successfully.

#### Parameters

in	<i>fileId</i>	Elementary File Identifier
in	<i>command</i>	APDU Command for SIM IO operation
in	<i>p1</i>	Instruction Param1 value of the APDU command
in	<i>p2</i>	Instruction Param2 value of the APDU command
in	<i>p3</i>	Number of bytes present in the data field of APDU command. If p3 is negative, a 4 byte APDU is sent to the SIM.
in	<i>filePath</i>	Path of the file
in	<i>data</i>	Data to be sent with the APDU, send empty or null string in case no data
in	<i>pin2</i>	Pin value of the SIM. Invalid attempt of PIN2 value will lock the SIM. send empty or null string in case of no Pin2 value
in	<i>aid</i>	Application identifier, send empty or null string in case of no aid
in	<i>callback</i>	Optional callback pointer to get the response of SIM IO request

#### Returns

- Status of exchangeSimIO i.e. success or suitable status code

**4.7.1.6.1.8** `virtual int telux::tel::ICard::getSlotId ( ) [pure virtual]`

Get associated slot id for [ICard](#)

#### Returns

SlotId

**4.7.1.6.1.9** `virtual telux::common::Status telux::tel::ICard::requestEid ( EidResponseCallback callback ) [pure virtual]`

Request eUICC identifier (EID) of eUICC card.

On platforms with access control enabled, caller needs to have TELUX\_TEL\_PRIVATE\_INFO\_READ permission to invoke this API successfully.



**Parameters**

in	<i>callback</i>	Callback function to get the result of request EID.
----	-----------------	---

**Returns**

Status of request EID i.e. success or suitable error code.

**Dependencies Card should be eUICC capable**

**4.7.1.6.1.10** `virtual std::shared_ptr<ICardFileHandler> telux::tel::ICard::getFileHandler ( ) [pure virtual]`

Get file handler for reading or writing to EF on SIM.

**Returns**

[ICardFileHandler](#)

**4.7.1.7 class telux::tel::ICardChannelCallback**

Interface for Card callback object. Client needs to implement this interface to get single shot responses for commands like open logical channel and close logical channel.

The methods in callback can be invoked from multiple different threads. The implementation should be thread safe.

**Public member functions**

- virtual void [onChannelResponse](#) (int channel, [IccResult](#) result, [telux::common::ErrorCode](#) error)=0

**4.7.1.7.1 Member Function Documentation**

**4.7.1.7.1.1** `virtual void telux::tel::ICardChannelCallback::onChannelResponse ( int channel, IccResult result, telux::common::ErrorCode error ) [pure virtual]`

This function is called with the response to the open logical channel operation.

**Parameters**

in	<i>channel</i>	Channel Id for the logical channel.
in	<i>result</i>	<a href="#">IccResult</a> of open logical channel.
in	<i>error</i>	<a href="#">telux::common::ErrorCode</a> of the request.

### 4.7.1.8 class telux::tel::ICardCommandCallback

#### Public member functions

- virtual void [onResponse](#) ([IccResult](#) result, [telux::common::ErrorCode](#) error)=0

#### 4.7.1.8.1 Member Function Documentation

##### 4.7.1.8.1.1 virtual void telux::tel::ICardCommandCallback::onResponse ( [IccResult](#) *result*, [telux::common::ErrorCode](#) *error* ) [pure virtual]

This function is called when SIM Card transmit APDU over Logical, Basic Channel and Exchange Sim IO.

#### Parameters

in	<i>result</i>	<a href="#">IccResult</a> of transmit APDU command
in	<i>error</i>	<a href="#">telux::common::ErrorCode</a> of the request, Possible error codes are <ul style="list-style-type: none"> <li>• <a href="#">telux::common::ErrorCode::SUCCESS</a></li> <li>• <a href="#">telux::common::ErrorCode::INTERNAL</a></li> <li>• <a href="#">telux::common::ErrorCode::NO_MEMORY</a></li> <li>• <a href="#">telux::common::ErrorCode::INVALID_ARG</a></li> <li>• <a href="#">telux::common::ErrorCode::MISSING_ARG</a></li> </ul>

### 4.7.1.9 class telux::tel::ICardListener

Interface for SIM Card Listener object. Client needs to implement this interface to get access to card services notifications on card state change.

The methods in listener can be invoked from multiple different threads. The implementation should be thread safe.

#### Public member functions

- virtual void [onCardInfoChanged](#) (int slotId)
- virtual [~ICardListener](#) ()

#### 4.7.1.9.1 Constructors and Destructors

##### 4.7.1.9.1.1 virtual telux::tel::ICardListener::~~ICardListener ( ) [virtual]

#### 4.7.1.9.2 Member Function Documentation

##### 4.7.1.9.2.1 virtual void telux::tel::ICardListener::onCardInfoChanged ( int *slotId* ) [virtual]

This function is called when info of card gets updated.

**Parameters**

in	<i>slotId</i>	Slot identifier.
----	---------------	------------------

**4.7.1.10 struct telux::tel::CardReaderStatus**

Structure contains identity of card reader status

**Data fields**

Type	Field	Description
int	id	Card Reader ID
bool	isRemovable	Card reader is removable
bool	isPresent	Card reader is present
bool	isID1size	Card reader present is ID-1 size
bool	isCardPresent	Card is present in reader
bool	isCard↔ PoweredOn	Card in reader is powered

**4.7.1.11 class telux::tel::ISapCardManager**

[ISapCardManager](#) provide APIs for SAP related operations.

**Public member functions**

- virtual bool [isReady](#) ()=0
- virtual std::future< bool > [onReady](#) ()=0
- virtual [telux::common::ServiceStatus getServiceStatus](#) ()=0
- virtual [telux::common::Status getState](#) (SapState &sapState)=0
- virtual [telux::common::Status requestSapState](#) (SapStateResponseCallback callback)=0
- virtual [telux::common::Status openConnection](#) (SapCondition sapCondition=SapCondition::SAP\_CONDITION\_BLOCK\_VOICE\_OR\_DATA, std::shared\_ptr< [telux::common::ICommandResponseCallback](#) > callback=nullptr)=0
- virtual [telux::common::Status closeConnection](#) (std::shared\_ptr< [telux::common::ICommandResponseCallback](#) > callback=nullptr)=0
- virtual [telux::common::Status requestAtr](#) (std::shared\_ptr< [IAtrResponseCallback](#) > callback=nullptr)=0
- virtual [telux::common::Status transmitApdu](#) (uint8\_t cla, uint8\_t instruction, uint8\_t p1, uint8\_t p2, uint8\_t lc, std::vector< uint8\_t > data, uint8\_t le=0, std::shared\_ptr< [ISapCardCommandCallback](#) > callback=nullptr)=0
- virtual [telux::common::Status requestSimPowerOff](#) (std::shared\_ptr< [telux::common::ICommandResponseCallback](#) > callback=nullptr)=0
- virtual [telux::common::Status requestSimPowerOn](#) (std::shared\_ptr< [telux::common::ICommandResponseCallback](#) > callback=nullptr)=0

- virtual [telux::common::Status requestSimReset](#) (std::shared\_ptr< [telux::common::ICommandResponseCallback](#) > callback=nullptr)=0
- virtual [telux::common::Status requestCardReaderStatus](#) (std::shared\_ptr< [ICardReaderCallback](#) > callback=nullptr)=0
- virtual int [getSlotId](#) ()=0
- virtual [telux::common::Status registerListener](#) (std::shared\_ptr< [ISapCardListener](#) > listener)=0
- virtual [telux::common::Status removeListener](#) (std::shared\_ptr< [ISapCardListener](#) > listener)=0
- virtual [~ISapCardManager](#) ()

#### 4.7.1.11.1 Constructors and Destructors

4.7.1.11.1.1 virtual [telux::tel::ISapCardManager::~ISapCardManager](#) ( ) [[virtual](#)]

#### 4.7.1.11.2 Member Function Documentation

4.7.1.11.2.1 virtual bool [telux::tel::ISapCardManager::isReady](#) ( ) [[pure virtual](#)]

Checks the status of SIM access profile(SAP) subsystem and returns the result.

##### Returns

If true then SapCardManager is ready for service.

##### Deprecated

Use [ISapCardManager::getServiceStatus\(\)](#) API.

4.7.1.11.2.2 virtual [std::future<bool>](#) [telux::tel::ISapCardManager::onReady](#) ( ) [[pure virtual](#)]

Wait for IM access profile(SAP) subsystem to be ready.

##### Returns

A future that caller can wait on to be notified when card manager is ready.

##### Deprecated

Use [InitResponseCb](#) in [PhoneFactory::getSapCardManager](#) instead, to get notified about subsystem readiness.

#### 4.7.1.11.2.3 **virtual telux::common::ServiceStatus telux::tel::ISapCardManager::getServiceStatus ( )** [pure virtual]

This status indicates whether the [ISapCardManager](#) object is in a usable state.

#### Returns

SERVICE\_AVAILABLE - If SAP card manager is ready for service. SERVICE\_UNAVAILABLE - If SAP card manager is temporarily unavailable. SERVICE\_FAILED - If SAP card manager encountered an irrecoverable failure.

#### 4.7.1.11.2.4 **virtual telux::common::Status telux::tel::ISapCardManager::getState ( SapState & sapState )** [pure virtual]

Get SIM access profile (SAP) client connection state.

#### Parameters

out	<i>sapState</i>	<a href="#">SapState</a> of the SIM Card
-----	-----------------	--

#### Returns

Status of getState i.e. success or suitable status code.

#### Deprecated

Use [requestSapState\(\)](#) API below to get SAP state

#### 4.7.1.11.2.5 **virtual telux::common::Status telux::tel::ISapCardManager::requestSapState ( SapStateResponseCallback callback )** [pure virtual]

Get SIM access profile(SAP) client connection state.

#### Parameters

out	<i>callback</i>	Callback function pointer to get the response of requestSapState.
-----	-----------------	---

#### Returns

Status of requestSapState i.e. success or suitable status code.

#### 4.7.1.11.2.6 **virtual telux::common::Status telux::tel::ISapCardManager::openConnection ( SapCondition sapCondition = SapCondition::SAP\_CONDITION\_BLOCK\_VOICE\_OR\_DATA, std::shared\_ptr< telux::common::ICommandResponseCallback > callback = nullptr )** [pure virtual]

Establishes SIM access profile (SAP) client connection with SIM Card.

**Parameters**

in	<i>sapCondition</i>	Condition to enable sap connection.
in	<i>callback</i>	Optional callback to get the response of open sap connection request or possible error codes i.e. <ul style="list-style-type: none"> <li>• <a href="#">telux::common::ErrorCode::SUCCESS</a></li> <li>• <a href="#">telux::common::ErrorCode::INTERNAL</a></li> <li>• <a href="#">telux::common::ErrorCode::NO_MEMORY</a></li> <li>• <a href="#">telux::common::ErrorCode::INVALID_ARG</a></li> <li>• <a href="#">telux::common::ErrorCode::MISSING_ARG</a></li> </ul>

**Returns**

Status of openConnection i.e. success or suitable status code.

**4.7.1.11.2.7** `virtual telux::common::Status telux::tel::ISapCardManager::closeConnection ( std::shared_ptr< telux::common::ICommandResponseCallback > callback = nullptr ) [pure virtual]`

Releases a SAP connection to SIM Card.

**Parameters**

in	<i>callback</i>	Optional callback to get the response of close sap connection request or possible error codes i.e. <ul style="list-style-type: none"> <li>• <a href="#">telux::common::ErrorCode::SUCCESS</a></li> <li>• <a href="#">telux::common::ErrorCode::INTERNAL</a></li> <li>• <a href="#">telux::common::ErrorCode::NO_MEMORY</a></li> <li>• <a href="#">telux::common::ErrorCode::INVALID_ARG</a></li> <li>• <a href="#">telux::common::ErrorCode::MISSING_ARG</a></li> </ul>
----	-----------------	---

**Returns**

Status of closeConnection i.e. success or suitable status code

**4.7.1.11.2.8** `virtual telux::common::Status telux::tel::ISapCardManager::requestAtr ( std::shared_ptr< IAtrResponseCallback > callback = nullptr ) [pure virtual]`

Request for SAP Answer To Reset command.

**Parameters**

in	<i>callback</i>	Optional callback to get the response of requestAtr.
----	-----------------	--

**Returns**

Status of requestAtr i.e. success or suitable status code.

**4.7.1.11.2.9** `virtual telux::common::Status telux::tel::ISapCardManager::transmitApdu ( uint8_t cla,  
uint8_t instruction, uint8_t p1, uint8_t p2, uint8_t lc, std::vector< uint8_t > data, uint8_t  
le = 0, std::shared_ptr< ISapCardCommandCallback > callback = nullptr ) [pure  
virtual]`

Send the Apdu on SAP mode.

#### Parameters

in	<i>cla</i>	Class of the APDU command.
in	<i>instruction</i>	Instruction of the APDU command.
in	<i>p1</i>	Instruction Parameter 1 value of the APDU command.
in	<i>p2</i>	Instruction Parameter 1 value of the APDU command.
in	<i>lc</i>	Number of bytes present in the data field of the APDU command. If <i>lc</i> is negative, a 4 byte APDU is sent to the SIM.
in	<i>data</i>	List of data to be sent with the APDU.
in	<i>le</i>	Maximum number of bytes expected in the data field of the response to the command.
in	<i>callback</i>	Optional callback to send APDU in SAP mode.

#### Returns

Status of transmitApdu i.e. success or suitable status code.

**4.7.1.11.2.10** `virtual telux::common::Status telux::tel::ISapCardManager::requestSimPowerOff (  
std::shared_ptr< telux::common::ICommandResponseCallback > callback = nullptr )  
[pure virtual]`

Send the SAP SIM power off request.

#### Parameters

in	<i>callback</i>	Optional callback to get the response for SIM power off.
----	-----------------	--

#### Returns

Status of requestSimPowerOff i.e. success or suitable status code.

**4.7.1.11.2.11** `virtual telux::common::Status telux::tel::ISapCardManager::requestSimPowerOn (  
std::shared_ptr< telux::common::ICommandResponseCallback > callback = nullptr )  
[pure virtual]`

Send the SAP SIM power on request.

#### Parameters

in	<i>callback</i>	Optional callback to get the response for SIM power on.
----	-----------------	---

**Returns**

Status of requestSimPowerOn i.e. success or suitable status code.

**4.7.1.11.2.12** `virtual telux::common::Status telux::tel::ISapCardManager::requestSimReset ( std::shared_ptr< telux::common::ICommandResponseCallback > callback = nullptr ) [pure virtual]`

Send the SAP SIM reset request.

**Parameters**

in	<i>callback</i>	Optional callback to get the response for SIM reset
----	-----------------	---

**Returns**

Status of requestSimReset i.e. success or suitable status code.

**4.7.1.11.2.13** `virtual telux::common::Status telux::tel::ISapCardManager::requestCardReaderStatus ( std::shared_ptr< ICardReaderCallback > callback = nullptr ) [pure virtual]`

Send the SAP Card Reader Status request command.

**Parameters**

in	<i>callback</i>	Optional callback to get the response for card reader status
----	-----------------	--

**Returns**

Status of requestCardReaderStatus i.e. success or suitable status code.

**4.7.1.11.2.14** `virtual int telux::tel::ISapCardManager::getSlotId ( ) [pure virtual]`

Get associated slot id for the SapCardManager.

**Returns**

SlotId

**4.7.1.11.2.15** `virtual telux::common::Status telux::tel::ISapCardManager::registerListener ( std::shared_ptr< ISapCardListener > listener ) [pure virtual]`

Register a listener for SAP events.

**Parameters**

in	<i>listener</i>	Pointer to <a href="#">ISapCardListener</a> object that processes the notification.
----	-----------------	---



**Returns**

Status of registerListener i.e. success or suitable status code.

**4.7.1.11.2.16** `virtual telux::common::Status telux::tel::ISapCardManager::removeListener ( std::shared_ptr< ISapCardListener > listener ) [pure virtual]`

Remove a previously added listener.

**Parameters**

in	<i>listener</i>	Pointer to <a href="#">ISapCardListener</a> object that needs to be removed.
----	-----------------	--

**Returns**

Status of removeListener i.e. success or suitable status code.

**4.7.1.12 class telux::tel::IAtrResponseCallback****Public member functions**

- virtual void [atrResponse](#) (std::vector< int > responseAtr, [telux::common::ErrorCode](#) error)=0

**4.7.1.12.1 Member Function Documentation**

**4.7.1.12.1.1** `virtual void telux::tel::IAtrResponseCallback::atrResponse ( std::vector< int > responseAtr, telux::common::ErrorCode error ) [pure virtual]`

This function is called in response to requestAtr() request.

**Parameters**

in	<i>responseAtr</i>	response ATR values
in	<i>error</i>	<a href="#">telux::common::ErrorCode</a> of the request possible error codes are <ul style="list-style-type: none"> <li>• <a href="#">telux::common::ErrorCode::SUCCESS</a></li> <li>• <a href="#">telux::common::ErrorCode::INTERNAL</a></li> <li>• <a href="#">telux::common::ErrorCode::NO_MEMORY</a></li> <li>• <a href="#">telux::common::ErrorCode::INVALID_ARG</a></li> <li>• <a href="#">telux::common::ErrorCode::MISSING_ARG</a></li> </ul>

**4.7.1.13 class telux::tel::ISapCardCommandCallback****Public member functions**

- virtual void [onResponse](#) ([IccResult](#) result, [telux::common::ErrorCode](#) error)=0

#### 4.7.1.13.1 Member Function Documentation

**4.7.1.13.1.1** virtual void telux::tel::ISapCardCommandCallback::onResponse ( IccResult *result*, telux::common::ErrorCode *error* ) [pure virtual]

This function is called when SIM Card transmit APDU on SAP mode.

##### Parameters

in	<i>result</i>	IccResult of transmit APDU command
in	<i>error</i>	telux::common::ErrorCode of the request, possible error codes are <ul style="list-style-type: none"> <li>telux::common::ErrorCode::SUCCESS</li> <li>telux::common::ErrorCode::INTERNAL</li> <li>telux::common::ErrorCode::NO_MEMORY</li> <li>telux::common::ErrorCode::INVALID_ARG</li> <li>telux::common::ErrorCode::MISSING_ARG</li> </ul>

#### 4.7.1.14 class telux::tel::ICardReaderCallback

##### Public member functions

- virtual void cardReaderResponse (CardReaderStatus cardReaderStatus, telux::common::ErrorCode error)=0

#### 4.7.1.14.1 Member Function Documentation

**4.7.1.14.1.1** virtual void telux::tel::ICardReaderCallback::cardReaderResponse ( CardReaderStatus *cardReaderStatus*, telux::common::ErrorCode *error* ) [pure virtual]

This function is called in response to requestCardReaderStatus() method.

##### Parameters

in	<i>cardReaderStatus</i>	Structure contains the identity of the card reader
in	<i>error</i>	telux::common::ErrorCode of the request

#### 4.7.1.15 class telux::tel::ISapCardListener

Interface for SAP Listener object. Client needs to implement this interface to get access to SAP service notifications like service status change.

The methods in listener can be invoked from multiple different threads. The implementation should be thread safe.

**Public member functions**

- virtual [~ISapCardListener](#) ()

**4.7.1.15.1 Constructors and Destructors**

4.7.1.15.1.1 virtual telux::tel::ISapCardListener::~~ISapCardListener ( ) [virtual]

**4.7.2 Enumeration Type Documentation****4.7.2.1 enum telux::tel::CardState [strong]**

Defines all state of Card like absent, present etc

**Enumerator**

**CARDSTATE\_UNKNOWN** Unknown card state  
**CARDSTATE\_ABSENT** Card is absent  
**CARDSTATE\_PRESENT** Card is present  
**CARDSTATE\_ERROR** Card is having error, either card is removed and not readable  
**CARDSTATE\_RESTRICTED** Card is present but not usable due to carrier restrictions.

**4.7.2.2 enum telux::tel::CardError [strong]**

Defines the reasons for error in CardState

**Enumerator**

**UNKNOWN** Unknown error  
**POWER\_DOWN** Power down  
**POLL\_ERROR** Poll error  
**NO\_ATR\_RECEIVED** No ATR received  
**VOLT\_MISMATCH** Volt mismatch  
**PARITY\_ERROR** Parity error  
**POSSIBLY\_REMOVED** Unknown, possibly removed  
**TECHNICAL\_PROBLEMS** Card returned technical problems  
**NULL\_BYTES** Card returned NULL bytes  
**SAP\_CONNECTED** Terminal in SAP mode  
**CMD\_TIMEOUT** Command timeout error

**4.7.2.3 enum telux::tel::CardLockType [strong]**

Defines all types of card locks which uses in PIN management APIs

**Enumerator**

**PIN1** Lock type is PIN1  
**PIN2** Lock type is PIN2  
**PUK1** Lock type is Pin Unblocking Key1  
**PUK2** Lock type is Pin Unblocking Key2  
**FDN** Lock type is Fixed Dialing Number

#### 4.7.2.4 enum telux::tel::AppType

Defines all type of UICC application such as SIM, RUIM, USIM, CSIM and ISIM.

##### Enumerator

**APPTYPE\_UNKNOWN** Unknown application type  
**APPTYPE\_SIM** UICC application type is SIM  
**APPTYPE\_USIM** UICC application type is USIM  
**APPTYPE\_RUIM** UICC application type is RSIM  
**APPTYPE\_CSIM** UICC application type is CSIM  
**APPTYPE\_ISIM** UICC application type is ISIM

#### 4.7.2.5 enum telux::tel::AppState

Defines all application states.

##### Enumerator

**APPSTATE\_UNKNOWN** Unknown application state  
**APPSTATE\_DETECTED** application state detected  
**APPSTATE\_PIN** If PIN1 or UPin is required  
**APPSTATE\_PUK** If PUK1 or Puk for UPin is required  
**APPSTATE\_SUBSCRIPTION\_PERSO** PersoSubstate should be look at when application state is assigned to this value  
**APPSTATE\_READY** application State is ready

#### 4.7.2.6 enum telux::tel::EfType [strong]

Defines supported elementary file(EF) types.

##### Enumerator

**UNKNOWN** Unknown EF type  
**TRANSPARENT** Transparent EF  
**LINEAR\_FIXED** Linear Fixed EF

#### 4.7.2.7 enum telux::tel::SapState [strong]

Defines all SIM access profile (SAP) connection states.

##### Enumerator

**SAP\_STATE\_NOT\_ENABLED** SAP connection not enabled  
**SAP\_STATE\_CONNECTING** SAP State is connecting  
**SAP\_STATE\_CONNECTED\_SUCCESSFULLY** SAP connection is successful  
**SAP\_STATE\_CONNECTION\_ERROR** SAP connection error  
**SAP\_STATE\_DISCONNECTING** SAP state is disconnecting  
**SAP\_STATE\_DISCONNECTED\_SUCCESSFULLY** SAP state disconnection is successful

#### 4.7.2.8 enum telx::tel::SapCondition [strong]

Indicates type of connection required, default behavior is to block a SAP connection when a voice or data call is active.

##### Enumerator

**SAP\_CONDITION\_BLOCK\_VOICE\_OR\_DATA** Block a SAP connection when a voice or data call is active (Default)

**SAP\_CONDITION\_BLOCK\_DATA** Block a SAP connection when a data call is active

**SAP\_CONDITION\_BLOCK\_VOICE** Block a SAP connection when a voice call is active

**SAP\_CONDITION\_BLOCK\_NONE** Allow Sap connection in all cases

## 4.8 Cell Broadcast

This section contains APIs related to configure, activate and receive 3GPP ETWS/CMAS cell broadcast messages.

### 4.8.1 Data Structure Documentation

#### 4.8.1.1 struct telux::tel::CellBroadcastFilter

Defines cellbroadcast message filter. Refer spec 3GPP TS 23.041 9.4.1.2.2 for message identifier. Eg: If user want to receive from 0x1112 to 0x1116 then, startMessageId is 0x1112 and endMessageId is 0x1116. If user want to receive only 0x1112, then both startMessageId and endMessageId is 0x1112.

##### Data fields

Type	Field	Description
int	startMessageId	Intended to receive start from which MessageType
int	endMessageId	Intended to receive upto which MessageType

#### 4.8.1.2 struct telux::tel::Point

[Point](#) represented by latitude and longitude.

##### Data fields

Type	Field	Description
double	latitude	
double	longitude	

#### 4.8.1.3 class telux::tel::Polygon

This class represents a simple polygon with different points.

##### Public member functions

- [Polygon](#) (std::vector< [Point](#) > vertices)
- std::vector< [Point](#) > [getVertices](#) ()

#### 4.8.1.3.1 Constructors and Destructors

##### 4.8.1.3.1.1 telux::tel::Polygon::Polygon ( std::vector< Point > vertices )

[Polygon](#) constructor.

##### Parameters

in	vertices	List of <a href="#">telux::tel::Point</a>
----	----------	---

### 4.8.1.3.2 Member Function Documentation

#### 4.8.1.3.2.1 `std::vector<Point> telux::tel::Polygon::getVertices ( )`

Get vertices of polygon.

#### Returns

List of [telux::tel::Point](#).

### 4.8.1.4 class `telux::tel::Circle`

This class represents a geometry represented as simple circle.

#### Public member functions

- [Circle](#) ([Point](#) center, double radius)
- [Point](#) `getCenter` ( )
- double `getRadius` ( )

#### 4.8.1.4.1 Constructors and Destructors

##### 4.8.1.4.1.1 `telux::tel::Circle::Circle ( Point center, double radius )`

[Circle](#) constructor.

#### Parameters

in	<i>center</i>	Center of circle represented by <a href="#">telux::tel::Point</a>
in	<i>radius</i>	Radius of circle in meters

#### 4.8.1.4.2 Member Function Documentation

##### 4.8.1.4.2.1 `Point telux::tel::Circle::getCenter ( )`

Get center point of circle.

#### Returns

Center of circle.

##### 4.8.1.4.2.2 `double telux::tel::Circle::getRadius ( )`

Get radius of circle.

#### Returns

Radius of circle.

### 4.8.1.5 class telux::tel::Geometry

This class represents warning area geometry to perform geofencing on alert.

#### Public member functions

- [Geometry](#) (std::shared\_ptr< [Polygon](#) > polygon)
- [Geometry](#) (std::shared\_ptr< [Circle](#) > circle)
- [GeometryType](#) [getType](#) () const
- std::shared\_ptr< [Polygon](#) > [getPolygon](#) () const
- std::shared\_ptr< [Circle](#) > [getCircle](#) () const

#### 4.8.1.5.1 Constructors and Destructors

##### 4.8.1.5.1.1 telux::tel::Geometry::Geometry ( std::shared\_ptr< [Polygon](#) > *polygon* )

[Geometry](#) constructor.

#### Parameters

in	<i>polygon</i>	<a href="#">Polygon</a>
----	----------------	-------------------------

##### 4.8.1.5.1.2 telux::tel::Geometry::Geometry ( std::shared\_ptr< [Circle](#) > *circle* )

[Geometry](#) constructor.

#### Parameters

in	<i>circle</i>	<a href="#">Circle</a>
----	---------------	------------------------

#### 4.8.1.5.2 Member Function Documentation

##### 4.8.1.5.2.1 [GeometryType](#) telux::tel::Geometry::[getType](#) ( ) const

Get the geometry type.

#### Returns

[GeometryType](#).



#### 4.8.1.5.2.2 `std::shared_ptr<Polygon> telux::tel::Geometry::getPolygon ( ) const`

Get polygon geometry as warning area to perform geofencing. This method should be called only if geometry type returned by `getType()` API is `GeometryType::POLYGON`

##### Returns

`Polygon` geometry object.

#### 4.8.1.5.2.3 `std::shared_ptr<Circle> telux::tel::Geometry::getCircle ( ) const`

Get circle geometry as warning area to perform geofencing. This method should be called only if geometry type returned by `getType()` API is `GeometryType::CIRCLE`

##### Returns

`Circle` geometry object.

### 4.8.1.6 `class telux::tel::WarningAreaInfo`

This class represents warning area information for alert.

#### Public member functions

- `WarningAreaInfo` (int `maxWaitTime`, `std::vector< Geometry > geometries`)
- int `getGeoFenceMaxWaitTime ()`
- `std::vector< Geometry > getGeometries ()`

#### 4.8.1.6.1 Constructors and Destructors

##### 4.8.1.6.1.1 `telux::tel::WarningAreaInfo::WarningAreaInfo ( int maxWaitTime, std::vector< Geometry > geometries )`

Warning Area Information constructor.

#### Parameters

in	<i>maxWaitTime</i>	Maximum wait time allowed to determine position for alert Range is 0 to 255 where 0 means Zero wait time, 1 - 254 is Geo-Fencing Maximum Wait Time in seconds and 255 means use device default wait time.
in	<i>geometries</i>	Geometries to perform geofencing on alert

#### 4.8.1.6.2 Member Function Documentation

#### 4.8.1.6.2.1 int telux::tel::WarningAreaInfo::getGeoFenceMaxWaitTime ( )

Get maximum wait time allowed to determine position for alert.

##### Returns

Maximum wait time for alert in seconds.

#### 4.8.1.6.2.2 std::vector<Geometry> telux::tel::WarningAreaInfo::getGeometries ( )

Get geometries to perform geofencing on alert.

##### Returns

List of [telux::tel::Geometry](#).

### 4.8.1.7 class telux::tel::EtwsInfo

Contains information elements for a GSM/UMTS/E-UTRAN/NG-RAN ETWS warning notification. Supported values for each element are defined in 3GPP TS 23.041.

#### Public member functions

- [EtwsInfo](#) ([GeographicalScope](#) geographicalScope, int msgId, int serialNumber, std::string languageCode, std::string messageText, [MessagePriority](#) priority, [EtwsWarningType](#) warningType, bool emergencyUserAlert, bool activatePopup, bool primary, std::vector< uint8\_t > warningSecurityInformation)
- [GeographicalScope](#) getGeographicalScope () const
- int getMessageId () const
- int getSerialNumber () const
- std::string getLanguageCode () const
- std::string getMessageBody () const
- [MessagePriority](#) getPriority () const
- int getMessageCode () const
- int getUpdateNumber () const
- [EtwsWarningType](#) getEtwsWarningType ()
- bool isEmergencyUserAlert ()
- bool isPopupAlert ()
- bool isPrimary ()
- std::vector< uint8\_t > getWarningSecurityInformation ()

#### 4.8.1.7.1 Constructors and Destructors

**4.8.1.7.1.1** `telux::tel::EtwsInfo::EtwsInfo ( GeographicalScope geographicalScope, int msgId, int serialNumber, std::string languageCode, std::string messageText, MessagePriority priority, EtwsWarningType warningType, bool emergencyUserAlert, bool activatePopup, bool primary, std::vector< uint8_t > warningSecurityInformation )`

[EtwsInfo](#) constructor.

##### Parameters

in	<i>geographicalScope</i>	<a href="#">GeographicalScope</a>
in	<i>msgId</i>	Unique message identifier
in	<i>serialNumber</i>	Serial number for message
in	<i>languageCode</i>	ISO-639-1 language code for message
in	<i>messageText</i>	Message text
in	<i>priority</i>	<a href="#">MessagePriority</a>
in	<i>warningType</i>	<a href="#">EtwsWarningType</a>
in	<i>emergencyUserAlert</i>	If true message is emergency user alert otherwise not
in	<i>activatePopup</i>	If true message message activate popup flag is set, otherwise popup flag is false.
in	<i>primary</i>	If true ETWS message is primary notification otherwise not
in	<i>warningSecurityInformation</i>	Buffer containing security information about ETWS primary notification such as timestamp and digital signature

#### 4.8.1.7.2 Member Function Documentation

**4.8.1.7.2.1** `GeographicalScope telux::tel::EtwsInfo::getGeographicalScope ( ) const`

Get the `geographicalScope` of cellbroadcast message.

##### Returns

[GeographicalScope](#).

**4.8.1.7.2.2** `int telux::tel::EtwsInfo::getMessageId ( ) const`

Get cellbroadcast message identifier. The message identifier identifies the type of the cell broadcast message defined in spec 3GPP TS 23.041 9.4.1.2.2

##### Returns

Message identifier.

**4.8.1.7.2.3 int telux::tel::EtwsInfo::getSerialNumber ( ) const**

Get the serial number of broadcast (geographical scope + message code + update number for GSM/UMTS).

**Returns**

int containing cellbroadcast serial number.

**4.8.1.7.2.4 std::string telux::tel::EtwsInfo::getLanguageCode ( ) const**

Get the ISO-639-1 language code for cell broadcast message, or empty string if unspecified. This is not applicable for ETWS primary notification.

**Returns**

Language code

**4.8.1.7.2.5 std::string telux::tel::EtwsInfo::getMessageBody ( ) const**

Get the body of cell broadcast message, or empty string if no body available. For ETWS primary notification based on message identifier pre canned message will be sent.

**Returns**

body or empty string

**4.8.1.7.2.6 MessagePriority telux::tel::EtwsInfo::getPriority ( ) const**

Get the priority for the cell broadcast message.

**Returns**

[MessagePriority](#).

**4.8.1.7.2.7 int telux::tel::EtwsInfo::getMessageCode ( ) const**

Get the cellbroadcast message code.

**Returns**

int containing cellbroadcast message code.

**4.8.1.7.2.8 int telux::tel::EtwsInfo::getUpdateNumber ( ) const**

Get the cellbroadcast message update number.

**Returns**

int containing cellbroadcast message's update number.

#### 4.8.1.7.2.9 **EtwsWarningType** telux::tel::EtwsInfo::getEtwsWarningType ( )

Get ETWS warning type.

##### **Returns**

[EtwsWarningType](#).

#### 4.8.1.7.2.10 **bool** telux::tel::EtwsInfo::isEmergencyUserAlert ( )

Returns the ETWS emergency user alert flag.

##### **Returns**

true to notify terminal to activate emergency user alert or false otherwise

#### 4.8.1.7.2.11 **bool** telux::tel::EtwsInfo::isPopupAlert ( )

Returns the ETWS activate popup flag.

##### **Returns**

true to notify terminal to activate display popup or false otherwise

#### 4.8.1.7.2.12 **bool** telux::tel::EtwsInfo::isPrimary ( )

Returns the ETWS format flag. This flag determine whether ETWS message is primary notification or not.

##### **Returns**

true if the message is primary message, otherwise secondary message

#### 4.8.1.7.2.13 **std::vector<uint8\_t>** telux::tel::EtwsInfo::getWarningSecurityInformation ( )

Returns security information about ETWS primary notification such as timestamp and digital signature(applicable only for GSM).

##### **Returns**

byte buffer

### 4.8.1.8 **class** telux::tel::CmasInfo

Contains information elements for a GSM/UMTS/E-UTRAN/NG-RAN CMAS warning notification. Supported values for each element are defined in 3GPP TS 23.041.

## Public member functions

- [CmasInfo](#) ([GeographicalScope](#) geographicalScope, int msgId, int serialNumber, std::string languageCode, std::string messageText, [MessagePriority](#) priority, [CmasMessageClass](#) messageClass, [CmasSeverity](#) severity, [CmasUrgency](#) urgency, [CmasCertainty](#) certainty, std::shared\_ptr<[WarningAreaInfo](#)> warningAreaInfo)
- [GeographicalScope](#) getGeographicalScope () const
- int getMessageId () const
- int getSerialNumber () const
- std::string getLanguageCode () const
- std::string getMessageBody () const
- [MessagePriority](#) getPriority () const
- int getMessageCode () const
- int getUpdateNumber () const
- [CmasMessageClass](#) getMessageClass ()
- [CmasSeverity](#) getSeverity ()
- [CmasUrgency](#) getUrgency ()
- [CmasCertainty](#) getCertainty ()
- std::shared\_ptr<[WarningAreaInfo](#)> getWarningAreaInfo ()

### 4.8.1.8.1 Constructors and Destructors

- 4.8.1.8.1.1 **telux::tel::CmasInfo::CmasInfo ( [GeographicalScope](#) *geographicalScope*, int *msgId*, int *serialNumber*, std::string *languageCode*, std::string *messageText*, [MessagePriority](#) *priority*, [CmasMessageClass](#) *messageClass*, [CmasSeverity](#) *severity*, [CmasUrgency](#) *urgency*, [CmasCertainty](#) *certainty*, std::shared\_ptr<[WarningAreaInfo](#)> *warningAreaInfo* )**

[CmasInfo](#) constructor.

#### Parameters

in	<i>geographicalScope</i>	<a href="#">GeographicalScope</a>
in	<i>msgId</i>	Unique message identifier
in	<i>serialNumber</i>	Serial number for message
in	<i>languageCode</i>	ISO-639-1 language code for message
in	<i>messageText</i>	Message text
in	<i>priority</i>	<a href="#">MessagePriority</a>
in	<i>messageClass</i>	<a href="#">CmasMessageClass</a>
in	<i>severity</i>	<a href="#">CmasSeverity</a>
in	<i>urgency</i>	<a href="#">CmasUrgency</a>
in	<i>certainty</i>	<a href="#">CmasCertainty</a>
in	<i>warningAreaInfo</i>	<a href="#">WarningAreaInfo</a>

#### 4.8.1.8.2 Member Function Documentation

##### 4.8.1.8.2.1 GeographicalScope telux::tel::CmasInfo::getGeographicalScope ( ) const

Get the geographicalScope of cellbroadcast message.

##### Returns

[GeographicalScope](#).

##### 4.8.1.8.2.2 int telux::tel::CmasInfo::getMessageId ( ) const

Get cellbroadcast message identifier. The message identifier identifies the type of the cell broadcast message defined in spec 3GPP TS 23.041 9.4.1.2.2

##### Returns

Message identifier.

##### 4.8.1.8.2.3 int telux::tel::CmasInfo::getSerialNumber ( ) const

Get the serial number of broadcast (geographical scope + message code + update number for GSM/UMTS).

##### Returns

int containing cellbroadcast serial number.

##### 4.8.1.8.2.4 std::string telux::tel::CmasInfo::getLanguageCode ( ) const

Get the ISO-639-1 language code for cell broadcast message, or empty string if unspecified. This is not applicable for ETWS primary notification.

##### Returns

Language code

##### 4.8.1.8.2.5 std::string telux::tel::CmasInfo::getMessageBody ( ) const

Get the body of cell broadcast message, or empty string if no body available. For ETWS primary notification based on message identifier pre canned message will be sent.

##### Returns

body or empty string

**4.8.1.8.2.6 MessagePriority telux::tel::CmasInfo::getPriority ( ) const**

Get the priority for the cell broadcast message.

**Returns**

[MessagePriority](#).

**4.8.1.8.2.7 int telux::tel::CmasInfo::getMessageCode ( ) const**

Get the cellbroadcast message code.

**Returns**

int containing cellbroadcast message code.

**4.8.1.8.2.8 int telux::tel::CmasInfo::getUpdateNumber ( ) const**

Get the cellbroadcast message update number.

**Returns**

int containing cellbroadcast message's update number.

**4.8.1.8.2.9 CmasMessageClass telux::tel::CmasInfo::getMessageClass ( )**

Get CMAS message class.

**Returns**

[CmasMessageClass](#).

**4.8.1.8.2.10 CmasSeverity telux::tel::CmasInfo::getSeverity ( )**

Get CMAS message severity.

**Returns**

[CmasSeverity](#).

**4.8.1.8.2.11 CmasUrgency telux::tel::CmasInfo::getUrgency ( )**

Get CMAS message urgency.

**Returns**

[CmasUrgency](#).



**4.8.1.8.2.12 CmasCertainty telux::tel::CmasInfo::getCertainty ( )**

Get CMAS message certainty.

**Returns**

[CmasCertainty](#).

**4.8.1.8.2.13 std::shared\_ptr<WarningAreaInfo> telux::tel::CmasInfo::getWarningAreaInfo ( )**

Returns warning area information for alert. This is applicable for LTE and NR5G

**Returns**

pointer to [WarningAreaInfo](#) or null if there is no warning area information available.

**4.8.1.9 class telux::tel::CellBroadcastMessage**

Cell Broadcast message.

**Public member functions**

- [CellBroadcastMessage](#) (std::shared\_ptr< [EtwsInfo](#) > etwsInfo)
- [CellBroadcastMessage](#) (std::shared\_ptr< [CmasInfo](#) > cmasInfo)
- [MessageType](#) getMessageType () const
- std::shared\_ptr< [EtwsInfo](#) > getEtwsInfo () const
- std::shared\_ptr< [CmasInfo](#) > getCmasInfo () const

**4.8.1.9.1 Constructors and Destructors****4.8.1.9.1.1 telux::tel::CellBroadcastMessage::CellBroadcastMessage ( std::shared\_ptr< EtwsInfo > etwsInfo )**

[CellBroadcastMessage](#) constructor.

**Parameters**

in	<i>etwsInfo</i>	<a href="#">EtwsInfo</a>
----	-----------------	--------------------------

**4.8.1.9.1.2 telux::tel::CellBroadcastMessage::CellBroadcastMessage ( std::shared\_ptr< CmasInfo > cmasInfo )**

[CellBroadcastMessage](#) constructor.

**Parameters**

in	<i>cmasInfo</i>	<a href="#">CmasInfo</a>
----	-----------------	--------------------------

**4.8.1.9.2 Member Function Documentation****4.8.1.9.2.1 MessageType telux::tel::CellBroadcastMessage::getMessageType ( ) const**

Get the cellbroadcast message type.

**Returns**

[MessageType](#).

**4.8.1.9.2.2 std::shared\_ptr<EtwsInfo> telux::tel::CellBroadcastMessage::getEtwsInfo ( ) const**

Get ETWS warning notification containing information about the ETWS warning type, the emergency user alert flag and the popup flag. This method should be called only if message type returned by [getMessageType\(\)](#) API is [MessageType::ETWS](#)

**Returns**

pointer to [EtwsInfo](#) or null if this is not an ETWS warning notification

**4.8.1.9.2.3 std::shared\_ptr<CmasInfo> telux::tel::CellBroadcastMessage::getCmasInfo ( ) const**

Get CMAS warning notification containing information about the CMAS message class, severity, urgency and certainty. This method should be called only if message type returned by [getMessageType\(\)](#) API is [MessageType::CMAS](#)

**Returns**

pointer to [CmasInfo](#) or null if this is not a CMAS warning notification

**4.8.1.10 class telux::tel::CellBroadcastManager**

CellBroadcastManager class is primary interface to configure and activate emergency broadcast messages and receive broadcast messages.

**Public member functions**

- virtual bool [isSubsystemReady](#) ()=0
- virtual std::future< bool > [onSubsystemReady](#) ()=0
- virtual [telux::common::ServiceStatus](#) [getServiceStatus](#) ()=0
- virtual SlotId [getSlotId](#) ()=0
- virtual [telux::common::Status](#) [updateMessageFilters](#) (std::vector< [CellBroadcastFilter](#) > filters,

[telux::common::ResponseCallback](#) callback=nullptr)=0

- virtual [telux::common::Status requestMessageFilters](#) ([RequestFiltersResponseCallback](#) callback)=0
- virtual [telux::common::Status setActivationStatus](#) (bool activate, [telux::common::ResponseCallback](#) callback=nullptr)=0
- virtual [telux::common::Status requestActivationStatus](#) ([RequestActivationStatusResponseCallback](#) callback)=0
- virtual [telux::common::Status registerListener](#) (std::weak\_ptr< [ICellBroadcastListener](#) > listener)=0
- virtual [telux::common::Status deregisterListener](#) (std::weak\_ptr< [ICellBroadcastListener](#) > listener)=0
- virtual [~ICellBroadcastManager](#) ()

#### 4.8.1.10.1 Constructors and Destructors

4.8.1.10.1.1 virtual [telux::tel::ICellBroadcastManager::~~ICellBroadcastManager](#) ( ) [**virtual**]

#### 4.8.1.10.2 Member Function Documentation

4.8.1.10.2.1 virtual bool [telux::tel::ICellBroadcastManager::isSubsystemReady](#) ( ) [**pure virtual**]

Checks the status of network subsystem and returns the result.

#### Deprecated

Use [ICellBroadcastManager::getServiceStatus\(\)](#) API.

#### Returns

True if network subsystem is ready for service otherwise false.

4.8.1.10.2.2 virtual [std::future<bool>](#) [telux::tel::ICellBroadcastManager::onSubsystemReady](#) ( ) [**pure virtual**]

Wait for network subsystem to be ready.

#### Deprecated

Use [InitResponseCb](#) in [PhoneFactory::getCellBroadcastManager](#) instead, to get notified about subsystem readiness.

#### Returns

A future that caller can wait on to be notified when network subsystem is ready.

#### 4.8.1.10.2.3 `virtual telux::common::ServiceStatus telux::tel::ICellBroadcastManager::getServiceStatus ( ) [pure virtual]`

This status indicates whether the [ICellBroadcastManager](#) object is in a usable state.

##### Returns

SERVICE\_AVAILABLE - If CellBroadcast Manager is ready for service.  
 SERVICE\_UNAVAILABLE - If CellBroadcast Manager is temporarily unavailable.  
 SERVICE\_FAILED - If CellBroadcast Manager encountered an irrecoverable failure.

##### Note

Eval: This is a new API and is being evaluated. It is subject to change and could break backwards compatibility.

#### 4.8.1.10.2.4 `virtual SlotId telux::tel::ICellBroadcastManager::getSlotId ( ) [pure virtual]`

Get associated slot for this CellBroadcastManager.

##### Returns

SlotId

#### 4.8.1.10.2.5 `virtual telux::common::Status telux::tel::ICellBroadcastManager::updateMessageFilters ( std::vector< CellBroadcastFilter > filters, telux::common::ResponseCallback callback = nullptr ) [pure virtual]`

Configures the broadcast messages to be received.

On platforms with access control enabled, caller needs to have TELUX\_TEL\_CELL\_BROADCAST\_CONFIG permission to invoke this API successfully.

##### Parameters

in	<i>filters</i>	List of filtered broadcast message identifiers.
in	<i>callback</i>	Optional callback to get the response of set cell broadcast filters.

##### Returns

Status of updateMessageIdFilters i.e. success or suitable error code.

#### 4.8.1.10.2.6 `virtual telux::common::Status telux::tel::ICellBroadcastManager::requestMessageFilters ( RequestFiltersResponseCallback callback ) [pure virtual]`

Retrieve configured message filters for which broadcast messages will be received.

On platforms with access control enabled, caller needs to have TELUX\_TEL\_CELL\_BROADCAST\_CONFIG permission to invoke this API successfully.

**Parameters**

in	<i>callback</i>	Callback to get the response of get cell broadcast filters.
----	-----------------	---

**Returns**

Status of requestMessageIdFilters i.e. success or suitable error code.

**4.8.1.10.2.7** `virtual telux::common::Status telux::tel::ICellBroadcastManager::setActivationStatus ( bool activate, telux::common::ResponseCallback callback = nullptr ) [pure virtual]`

Allows activation and deactivation of configured broadcast messages.

On platforms with access control enabled, caller needs to have TELUX\_TEL\_CELL\_BROADCAST\_CONFIG permission to invoke this API successfully.

**Parameters**

in	<i>activate</i>	Activate/deactivate broadcast messages.
in	<i>callback</i>	Optional callback pointer to get the response.

**Returns**

Status of setActivationStatus i.e. success or suitable error code.

**4.8.1.10.2.8** `virtual telux::common::Status telux::tel::ICellBroadcastManager::requestActivationStatus ( RequestActivationStatusResponseCallback callback ) [pure virtual]`

Get activation status for configured broadcast messages.

On platforms with access control enabled, caller needs to have TELUX\_TEL\_CELL\_BROADCAST\_CONFIG permission to invoke this API successfully.

**Parameters**

in	<i>callback</i>	Callback pointer to get the response.
----	-----------------	---------------------------------------

**Returns**

Status of requestActivationStatus i.e. success or suitable error code.

**4.8.1.10.2.9** `virtual telux::common::Status telux::tel::ICellBroadcastManager::registerListener ( std::weak_ptr< ICellBroadcastListener > listener ) [pure virtual]`

Register a listener for cell broadcast messages.

**Parameters**

in	<i>listener</i>	Pointer to <a href="#">ICellBroadcastListener</a> object which receives broadcast message.
----	-----------------	--

**Returns**

Status of registerListener i.e. success or suitable error code.

**4.8.1.10.2.10** `virtual telux::common::Status telux::tel::ICellBroadcastManager::deregisterListener ( std::weak_ptr< ICellBroadcastListener > listener ) [pure virtual]`

De-register the listener.

**Parameters**

in	<i>listener</i>	Listener to be de-registered
----	-----------------	------------------------------

**Returns**

Status of deregisterListener i.e. success or suitable error code.

**4.8.1.11 class telux::tel::ICellBroadcastListener**

A listener class which monitors cell broadcast messages.

The methods in listener can be invoked from multiple different threads. The implementation should be thread safe.

**Public member functions**

- virtual void [onIncomingMessage](#) (SlotId slotId, const std::shared\_ptr< [CellBroadcastMessage](#) > cbMessage)
- virtual void [onMessageFilterChange](#) (SlotId slotId, std::vector< [CellBroadcastFilter](#) > filters)
- virtual [~ICellBroadcastListener](#) ()

**4.8.1.11.1 Constructors and Destructors**

**4.8.1.11.1.1** `virtual telux::tel::ICellBroadcastListener::~~ICellBroadcastListener ( ) [virtual]`

**4.8.1.11.2 Member Function Documentation**

**4.8.1.11.2.1** `virtual void telux::tel::ICellBroadcastListener::onIncomingMessage ( SlotId slotId, const std::shared_ptr< CellBroadcastMessage > cbMessage ) [virtual]`

This function is called when device receives an incoming cell broadcast message.

On platforms with access control enabled, the client needs to have TELUX\_TEL\_CELL\_BROADCAST\_LISTEN permission to invoke this API successfully.

**Parameters**

in	<i>slotId</i>	- Slot Id on which broadcast message is received.
in	<i>cbMessage</i>	- Broadcast message with information related to ETWS/CMAS notification.

**4.8.1.11.2 virtual void telux::tel::ICellBroadcastListener::onMessageFilterChange ( SlotId *slotId*, std::vector< CellBroadcastFilter > *filters* ) [virtual]**

This function is called when there is change in broadcast configuration like updation of message filters by the client using [ICellBroadcastManager::updateMessageFilters](#).

On platforms with access control enabled, the client needs to have TELUX\_TEL\_CELL\_BROADCAST\_CONFIG permission to invoke this API successfully.

**Parameters**

in	<i>slotId</i>	- Slot Id on which change in message filters is received.
in	<i>filters</i>	- Complete list of configured broadcast message filters.

## 4.8.2 Enumeration Type Documentation

### 4.8.2.1 enum telux::tel::GeographicalScope [strong]

Defines geographical scope of cell broadcast.

**Enumerator**

**CELL\_WIDE\_IMMEDIATE** Cell wide geographical scope with immediate display

**PLMN\_WIDE** PLMN wide geographical scope

**LA\_WIDE**

**CELL\_WIDE** Location / Service/ Tracking area wide geographical scope (GSM/UMTS/E-UTRAN/NG-RAN). Cell wide geographical scope

### 4.8.2.2 enum telux::tel::MessagePriority [strong]

Defines priority for cell broadcast message.

**Enumerator**

**UNKNOWN** Unknown message priority

**NORMAL** Normal message priority

**EMERGENCY** Emergency message priority

### 4.8.2.3 enum telux::tel::MessageType [strong]

Defines message type for cell broadcast message.

**Enumerator**

**UNKNOWN** Unknown message type  
**ETWS** Earthquake and Tsunami Warning System  
**CMAS** Commercial Mobile Alert System

**4.8.2.4 enum telux::tel::EtwsWarningType [strong]**

Defines warning type for ETWS cell broadcast message.

**Enumerator**

**UNKNOWN** Unknown ETWS warning type  
**EARTHQUAKE** ETWS warning type for earthquake  
**TSUNAMI** ETWS warning type for tsunami  
**EARTHQUAKE\_AND\_TSUNAMI** ETWS warning type for earthquake and tsunami  
**TEST\_MESSAGE** ETWS warning type for test messages  
**OTHER\_EMERGENCY** ETWS warning type for other emergency types

**4.8.2.5 enum telux::tel::CmasMessageClass [strong]**

Defines message class for CMAS cell broadcast message.

**Enumerator**

**UNKNOWN** CMAS category for warning types that are reserved for future extension  
**PRESIDENTIAL\_LEVEL\_ALERT** Presidential-level alert (Korean Public Alert System Class 0 message)  
**EXTREME\_THREAT** Extreme threat to life and property (Korean Public Alert System Class 1 message)  
**SEVERE\_THREAT** Severe threat to life and property (Korean Public Alert System Class 1 message).  
**CHILD\_ABDUCTION\_EMERGENCY** Child abduction emergency (AMBER Alert)  
**REQUIRED\_MONTHLY\_TEST** CMAS test message  
**CMAS\_EXERCISE** CMAS exercise  
**OPERATOR\_DEFINED\_USE** CMAS category for operator defined use

**4.8.2.6 enum telux::tel::CmasSeverity [strong]**

Defines severity type for CMAS cell broadcast message.

**Enumerator**

**UNKNOWN** CMAS alert severity is unknown. The severity is available for all GSM/UMTS alerts except for the Presidential-level alert class (Korean Public Alert System Class 0).  
**EXTREME** Extraordinary threat to life or property  
**SEVERE** Significant threat to life or property

**4.8.2.7 enum telux::tel::CmasUrgency [strong]**

Defines urgency type for CMAS cell broadcast message.



**Enumerator**

**UNKNOWN** CMAS alert urgency is unknown. The urgency is available for all GSM/UMTS alerts except for the Presidential-level alert class (Korean Public Alert System Class 0).

**IMMEDIATE** Responsive action should be taken immediately

**EXPECTED** Responsive action should be taken within the next hour

**4.8.2.8 enum telx::tel::CmasCertainty [strong]**

Defines certainty type for CMAS cell broadcast message.

**Enumerator**

**UNKNOWN** CMAS alert certainty is unknown. The certainty is available for all GSM/UMTS alerts except for the Presidential-level alert class (Korean Public Alert System Class 0).

**OBSERVED** Determined to have occurred or to be ongoing.

**LIKELY** Likely (probability > ~50%)

**4.8.2.9 enum telx::tel::GeometryType [strong]**

Defines geometry type specified in wireless emergency alert.

**Enumerator**

**UNKNOWN** Unknown geometry type

**POLYGON** Polygon geometry type

**CIRCLE** Circle geometry type

## 4.9 IMS Settings

This section contains APIs related to IMS Configuration.

### 4.9.1 Data Structure Documentation

#### 4.9.1.1 struct telux::tel::ImsServiceConfig

Defines the selected IMS service configuration parameters and their corresponding value

##### Data fields

Type	Field	Description
<a href="#">ImsService↔ ConfigValidity</a>	config↔ ValidityMask	Indicates the configurations type. Bit set to 1 denotes the config is valid.
bool	imsService↔ Enabled	Enable/Disable IMS service
bool	voImsEnabled	Enable/Disable VOIMS service
bool	smsEnabled	Enable/Disable SMS service

#### 4.9.1.2 class telux::tel::ImsSettingsManager

ImsSettingsManager allows IMS settings. For example enabling or disabling IMS service, VOIMS service.

##### Public member functions

- virtual [telux::common::ServiceStatus](#) getServiceStatus ()=0
- virtual [telux::common::Status](#) requestServiceConfig (SlotId slotId, [ImsServiceConfigCb](#) callback)=0
- virtual [telux::common::Status](#) setServiceConfig (SlotId slotId, [ImsServiceConfig](#) config, [common::ResponseCallback](#) callback=nullptr)=0
- virtual [telux::common::Status](#) registerListener (std::weak\_ptr< [ImsSettingsListener](#) > listener)=0
- virtual [telux::common::Status](#) deregisterListener (std::weak\_ptr< [ImsSettingsListener](#) > listener)=0
- virtual [~ImsSettingsManager](#) ()

##### 4.9.1.2.1 Constructors and Destructors

4.9.1.2.1.1 virtual [telux::tel::ImsSettingsManager::~ImsSettingsManager](#) ( ) [[virtual](#)]

##### 4.9.1.2.2 Member Function Documentation

#### 4.9.1.2.2.1 **virtual telux::common::ServiceStatus telux::tel::ImsSettingsManager::getServiceStatus ( )** [pure virtual]

This status indicates whether the [ImsSettingsManager](#) object is in a usable state.

#### Returns

SERVICE\_AVAILABLE - If IMS settings manager is ready for service. SERVICE\_UNAVAILABLE - If IMS settings manager is temporarily unavailable. SERVICE\_FAILED - If IMS settings manager encountered an irrecoverable failure.

#### 4.9.1.2.2.2 **virtual telux::common::Status telux::tel::ImsSettingsManager::requestServiceConfig ( SlotId *slotId*, ImsServiceConfigCb *callback* )** [pure virtual]

Request the IMS service configurations

#### Parameters

in	<i>slotId</i>	Slot for which the IMS service configurations is requested.
in	<i>callback</i>	Callback function to get the response of request IMS service configurations.

#### Returns

Status of requestServiceConfig i.e. success or suitable error code.

#### 4.9.1.2.2.3 **virtual telux::common::Status telux::tel::ImsSettingsManager::setServiceConfig ( SlotId *slotId*, ImsServiceConfig *config*, common::ResponseCallback *callback* = nullptr )** [pure virtual]

To configure the IMS service configurations. Also specify whether configuration needs to be enabled or disabled.

On platforms with Access control enabled, Caller needs to have TELUX\_TEL\_IMS\_SETTINGS permission to invoke this API successfully.

#### Parameters

in	<i>slotId</i>	Slot for which the IMS service configuration is intended.
in	<i>config</i>	Indicates which configuration are configured currently and whether the config is enabled or disabled. <a href="#">ImsServiceConfig</a> .
in	<i>callback</i>	Callback function to get the response of set IMS service configuration request.

#### Returns

Status of setServiceConfig i.e. success or suitable error code.

**4.9.1.2.2.4** virtual telux::common::Status telux::tel::ImsSettingsManager::registerListener ( std::weak\_ptr< ImsSettingsListener > *listener* ) [pure virtual]

Register a listener for specific events in the IMS settings subsystem.

#### Parameters

in	<i>listener</i>	Pointer to <a href="#">ImsSettingsListener</a> object that processes the notification
----	-----------------	---

#### Returns

Status of registerListener i.e. success or suitable error code.

**4.9.1.2.2.5** virtual telux::common::Status telux::tel::ImsSettingsManager::deregisterListener ( std::weak\_ptr< ImsSettingsListener > *listener* ) [pure virtual]

Deregister the previously added listener.

#### Parameters

in	<i>listener</i>	Pointer to <a href="#">ImsSettingsListener</a> object that needs to be deregistered.
----	-----------------	--

#### Returns

Status of deregisterListener i.e. success or suitable error code.

### 4.9.1.3 class telux::tel::ImsSettingsListener

Listener class for getting IMS service configuration change notifications. The listener method can be invoked from multiple different threads. Client needs to make sure that implementation is thread-safe.

#### Public member functions

- virtual void [onImsServiceConfigsChange](#) (SlotId slotId, [ImsServiceConfig](#) config)
- virtual void [onServiceStatusChange](#) (telux::common::ServiceStatus status)
- virtual [~ImsSettingsListener](#) ()

#### 4.9.1.3.1 Constructors and Destructors

**4.9.1.3.1.1** virtual telux::tel::ImsSettingsListener::~~ImsSettingsListener ( ) [virtual]

Destructor of [ImsSettingsListener](#)

### 4.9.1.3.2 Member Function Documentation

#### 4.9.1.3.2.1 virtual void telx::tel::ImsSettingsListener::onImsServiceConfigsChange ( SlotId *slotId*, ImsServiceConfig *config* ) [virtual]

This function is called whenever any IMS service configuration is changed.

##### Parameters

in	<i>slotId</i>	SIM corresponding to slot identifier for which the IMS service configuration has changed.
in	<i>config</i>	Indicates which configuration is valid and whether the config is enabled or disabled. <a href="#">ImsServiceConfig</a> .

#### 4.9.1.3.2.2 virtual void telx::tel::ImsSettingsListener::onServiceStatusChange ( telx::common::ServiceStatus *status* ) [virtual]

This function is called when [ImsSettingsManager](#) service status changes.

##### Parameters

in	<i>status</i>	- <a href="#">telx::common::ServiceStatus</a>
----	---------------	---

## 4.9.2 Enumeration Type Documentation

### 4.9.2.1 enum telx::tel::ImsServiceConfigType

Defines the IMS service configuration parameters

##### Enumerator

**IMSSETTINGS\_VOIMS** Voice calling support on LTE  
**IMSSETTINGS\_IMS\_SERVICE** IMS Normal Registration configuration  
**IMSSETTINGS\_SMS** SMS support on IMS

## 4.10 Multi SIM

This section contains APIs related to Multi SIM DSDA Configuration.

### 4.10.1 Data Structure Documentation

#### 4.10.1.1 struct telux::tel::SlotStatus

Represents status of a physical SIM slot

##### Data fields

Type	Field	Description
<a href="#">SlotState</a>	slotState	State of the physical SIM slot
<a href="#">CardState</a>	cardState	Status of the card in the physical slot
<a href="#">CardError</a>	cardError	Indicates the reason for the card error, and is valid only when the card state is CARDSTATE_ERROR.

#### 4.10.1.2 class telux::tel::IMultiSimManager

MultiSimManager allows to perform operation pertaining to devices which have more than one SIM/UICC card. Clients should check if the subsystem is ready before invoking any of the APIs as follows.

```
bool isReady = MultiSimManager->isSubsystemReady();
```

##### Public member functions

- virtual bool [isSubsystemReady](#) ()=0
- virtual std::future< bool > [onSubsystemReady](#) ()=0
- virtual [telux::common::ServiceStatus getServiceStatus](#) ()=0
- virtual [telux::common::Status getSlotCount](#) (int &count)=0
- virtual [telux::common::Status requestHighCapability](#) ([HighCapabilityCallback](#) callback)=0
- virtual [telux::common::Status setHighCapability](#) (int slotId, [common::ResponseCallback](#) callback=nullptr)=0
- virtual [telux::common::Status switchActiveSlot](#) (SlotId slotId, [common::ResponseCallback](#) callback=nullptr)=0
- virtual [telux::common::Status requestSlotStatus](#) ([SlotStatusCallback](#) callback)=0
- virtual [telux::common::Status registerListener](#) (std::weak\_ptr< [IMultiSimListener](#) > listener)=0
- virtual [telux::common::Status deregisterListener](#) (std::weak\_ptr< [IMultiSimListener](#) > listener)=0
- virtual [~IMultiSimManager](#) ()

### 4.10.1.2.1 Constructors and Destructors

4.10.1.2.1.1 `virtual telux::tel::IMultiSimManager::~IMultiSimManager ( ) [virtual]`

### 4.10.1.2.2 Member Function Documentation

4.10.1.2.2.1 `virtual bool telux::tel::IMultiSimManager::isSubsystemReady ( ) [pure virtual]`

Checks the status of Multi SIM subsystem and returns the result.

#### Returns

If true MultiSimManager is ready.

#### Deprecated

Use [IMultiSimManager::getServiceStatus\(\)](#) API.

4.10.1.2.2.2 `virtual std::future<bool> telux::tel::IMultiSimManager::onSubsystemReady ( ) [pure virtual]`

Wait for Multi SIM subsystem to be ready.

#### Returns

A future that caller can wait on to be notified when Multi SIM subsystem is ready.

#### Deprecated

Use `InitResponseCb` in [PhoneFactory::getMultiSimManager](#) instead, to get notified about subsystem readiness.

4.10.1.2.2.3 `virtual telux::common::ServiceStatus telux::tel::IMultiSimManager::getServiceStatus ( ) [pure virtual]`

This status indicates whether the [IMultiSimManager](#) object is in a usable state.

#### Returns

`SERVICE_AVAILABLE` - If MultiSim manager is ready for service. `SERVICE_UNAVAILABLE` - If MultiSim manager is temporarily unavailable. `SERVICE_FAILED` - If MultiSim manager encountered an irrecoverable failure.

#### Note

Eval: This is a new API and is being evaluated. It is subject to change and could break backwards compatibility.

#### 4.10.1.2.2.4 **virtual telux::common::Status telux::tel::IMultiSimManager::getSlotCount ( int & *count* )** [pure virtual]

Get SIM slot count. The count can be used to determine whether the device supports multi SIM.

##### Parameters

out	<i>count</i>	Slot count.
-----	--------------	-------------

##### Returns

Status of getSlotCount i.e. success or suitable error code.

#### 4.10.1.2.2.5 **virtual telux::common::Status telux::tel::IMultiSimManager::requestHighCapability ( HighCapabilityCallback *callback* )** [pure virtual]

Request to find out which SIM/slot is allowed to use advance Radio Technology like 5G at a time. For example SIM/slot with high capability may allowed to use RAT capabilities like 5G/4G/3G/2G while the SIM/slot with low capability may be allowed to use RAT capabilities like 4G/2G.

##### Parameters

in	<i>callback</i>	Callback function to get the response of request high capability.
----	-----------------	---

##### Returns

Status of requestHighCapability i.e. success or suitable error code.

#### 4.10.1.2.2.6 **virtual telux::common::Status telux::tel::IMultiSimManager::setHighCapability ( int *slotId*, common::ResponseCallback *callback* = nullptr )** [pure virtual]

Set SIM/slot with high capability asynchronously. On dual SIM devices, only one SIM may be allowed to use advanced Radio technology like 5G at a time. This API sets the SIM/slot that should be allowed the highest RAT capability. The other SIM/slot will be given lower RAT capabilities. For example, SIM in slot1 will be allowed 2G/3G/4G/5G and the SIM in slot2 will be allowed only 2G/4G.

On platforms with Access control enabled, Caller needs to have TELUX\_TEL\_MULTISIM\_MGMT permission to invoke this API successfully.

##### Parameters

in	<i>slotId</i>	Slot set with high capability.
in	<i>callback</i>	Callback function to get the response of set high capability request.

##### Returns

Status of setHighCapability i.e. success or suitable error code.



#### 4.10.1.2.2.7 virtual telux::common::Status telux::tel::IMultiSimManager::switchActiveSlot ( SlotId slotId, common::ResponseCallback callback = nullptr ) [pure virtual]

Choose the physical SIM slot to be used by modem on Single-SIM TCU platforms. After switching the slot, only the SIM on chosen physical slot can be used for WWAN functionality.

On platforms with Access control enabled, Caller needs to have TELUX\_TEL\_MULTISIM\_MGMT permission to invoke this API successfully.

##### Parameters

in	<i>slotId</i>	physical slot to be made active
in	<i>callback</i>	Callback function to get the response of slot switch request

##### Returns

Status of switchActiveSlot i.e. success or suitable error code.

#### 4.10.1.2.2.8 virtual telux::common::Status telux::tel::IMultiSimManager::requestSlotStatus ( SlotStatusCallback callback ) [pure virtual]

Request the status of physical slots.

##### Parameters

in	<i>callback</i>	Callback function to get the response of slot status request
----	-----------------	--

##### Returns

Status of requestSlotStatus i.e. success or suitable error code.

#### 4.10.1.2.2.9 virtual telux::common::Status telux::tel::IMultiSimManager::registerListener ( std::weak\_ptr< IMultiSimListener > listener ) [pure virtual]

Register a listener for specific events in the Multi SIM subsystem.

##### Parameters

in	<i>listener</i>	Pointer to <a href="#">IMultiSimListener</a> object that processes the notification
----	-----------------	---

##### Returns

Status of registerListener i.e. success or suitable error code.

**4.10.1.2.2.10** `virtual telux::common::Status telux::tel::IMultiSimManager::deregisterListener ( std::weak_ptr< IMultiSimListener > listener ) [pure virtual]`

Deregister the previously added listener.

#### Parameters

in	<i>listener</i>	Pointer to <a href="#">IMultiSimListener</a> object that needs to be deregistered.
----	-----------------	--

#### Returns

Status of deregisterListener i.e. success or suitable error code.

### 4.10.1.3 class telux::tel::IMultiSimListener

Listener class for getting high capability change notification. The listener method can be invoked from multiple different threads. Client needs to make sure that implementation is thread-safe.

#### Public member functions

- virtual void [onHighCapabilityChanged](#) (int slotId)
- virtual void [onSlotStatusChanged](#) (std::map< SlotId, SlotStatus > slotStatus)
- virtual [~IMultiSimListener](#) ()

#### 4.10.1.3.1 Constructors and Destructors

**4.10.1.3.1.1** `virtual telux::tel::IMultiSimListener::~~IMultiSimListener ( ) [virtual]`

Destructor of [IMultiSimListener](#)

#### 4.10.1.3.2 Member Function Documentation

**4.10.1.3.2.1** `virtual void telux::tel::IMultiSimListener::onHighCapabilityChanged ( int slotId ) [virtual]`

This function is called whenever there is change in high capability for SIM/slot.

#### Parameters

in	<i>slotId</i>	SIM corresponding to slot identifier has high capability now.
----	---------------	---

**4.10.1.3.2.2** virtual void telux::tel::IMultiSimListener::onSlotStatusChanged ( std::map< SlotId, SlotStatus > *slotStatus* ) [virtual]

This function is called whenever there is change in physical SIM slots status.

#### Parameters

in	<i>slotStatus</i>	list of slots status <a href="#">SlotStatus</a>
----	-------------------	---

## 4.10.2 Enumeration Type Documentation

**4.10.2.1** enum telux::tel::SlotState [strong]

Represents state of the physical SIM slot

#### Enumerator

**UNKNOWN**

**INACTIVE** Slot is inactive

**ACTIVE** Slot is active

## 4.11 Subscription Management

This section contains APIs related to Subscription Management.

### 4.11.1 Data Structure Documentation

#### 4.11.1.1 class telux::tel::ISubscription

Subscription returns information about network operator subscription details pertaining to a SIM card.

##### Public member functions

- virtual std::string [getCarrierName](#) ()=0
- virtual std::string [getIccId](#) ()=0
- virtual int [getMcc](#) ()=0
- virtual int [getMnc](#) ()=0
- virtual std::string [getMobileCountryCode](#) ()=0
- virtual std::string [getMobileNetworkCode](#) ()=0
- virtual std::string [getPhoneNumber](#) ()=0
- virtual int [getSlotId](#) ()=0
- virtual std::string [getImsi](#) ()=0
- virtual std::string [getGID1](#) ()=0
- virtual std::string [getGID2](#) ()=0
- virtual [~ISubscription](#) ()

##### 4.11.1.1.1 Constructors and Destructors

**4.11.1.1.1.1 virtual telux::tel::ISubscription::~~ISubscription ( ) [virtual]**

##### 4.11.1.1.2 Member Function Documentation

**4.11.1.1.2.1 virtual std::string telux::tel::ISubscription::getCarrierName ( ) [pure virtual]**

Retrieves the name of the carrier on which this subscription is made.

On platforms with Access control enabled, Caller needs to have TELUX\_TEL\_SUB\_PRIVATE\_INFO permission to invoke this API successfully.

##### Returns

Name of the carrier.

**4.11.1.1.2.2 virtual std::string telux::tel::ISubscription::getIccid ( ) [pure virtual]**

Retrieves the SIM's ICCID (Integrated Chip ID) - i.e SIM Serial Number.

On platforms with Access control enabled, Caller needs to have TELUX\_TEL\_PRIVATE\_INFO\_READ permission to invoke this API successfully.

**Returns**

Integrated Chip Id.

**4.11.1.1.2.3 virtual int telux::tel::ISubscription::getMcc ( ) [pure virtual]**

Retrieves the mobile country code of the carrier to which the phone is connected.

On platforms with Access control enabled, Caller needs to have TELUX\_TEL\_SUBSCRIPTION\_READ permission to invoke this API successfully.

**Returns**

Mobile Country Code.

**Deprecated**

Use [telux::tel::ISubscription::getMobileCountryCode\(\)](#) API instead

**4.11.1.1.2.4 virtual int telux::tel::ISubscription::getMnc ( ) [pure virtual]**

Retrieves the mobile network code of the carrier to which phone is connected.

On platforms with Access control enabled, Caller needs to have TELUX\_TEL\_SUBSCRIPTION\_READ permission to invoke this API successfully.

**Returns**

Mobile Network Code.

**Deprecated**

Use [telux::tel::ISubscription::getMobileNetworkCode\(\)](#) API instead

**4.11.1.1.2.5 virtual std::string telux::tel::ISubscription::getMobileCountryCode ( ) [pure virtual]**

Retrieves the mobile country code(MCC) of the carrier to which the phone is connected.

On platforms with Access control enabled, Caller needs to have TELUX\_TEL\_SUBSCRIPTION\_READ permission to invoke this API successfully.

**Returns**

mcc.

**4.11.1.1.2.6 virtual std::string telux::tel::ISubscription::getMobileNetworkCode ( ) [pure virtual]**

Retrieves the mobile network code(MNC) of the carrier to which the phone is connected.

On platforms with Access control enabled, Caller needs to have TELUX\_TEL\_SUBSCRIPTION\_READ permission to invoke this API successfully.

**Returns**

mnc.

**4.11.1.1.2.7 virtual std::string telux::tel::ISubscription::getPhoneNumber ( ) [pure virtual]**

Retrieves the phone number for the SIM subscription.

On platforms with Access control enabled, Caller needs to have TELUX\_TEL\_SUB\_PRIVATE\_INFO permission to invoke this API successfully.

**Returns**

PhoneNumber.

**4.11.1.1.2.8 virtual int telux::tel::ISubscription::getSlotId ( ) [pure virtual]**

Retrieves SIM Slot index for the SIM pertaining to this subscription object.

On platforms with Access control enabled, Caller needs to have TELUX\_TEL\_SUBSCRIPTION\_READ permission to invoke this API successfully.

**Returns**

SIM slotId.

**4.11.1.1.2.9 virtual std::string telux::tel::ISubscription::getImsi ( ) [pure virtual]**

Retrieves IMSI (International Mobile Subscriber Identity) for the SIM. This will have home network MCC and MNC values.

On platforms with Access control enabled, Caller needs to have TELUX\_TEL\_SUB\_PRIVATE\_INFO permission to invoke this API successfully.

**Returns**

imsi.

#### 4.11.1.1.2.10 virtual std::string telux::tel::ISubscription::getGID1 ( ) [pure virtual]

Retrieves the GID1(group identifier level1) on the SIM. It represents identifier for particular SIM and ME associations. It can be used to identify a group of SIMs for a particular application. Defined in 3GPP Spec 131.102 section 4.2.10

On platforms with Access control enabled, Caller needs to have TELUX\_TEL\_SUBSCRIPTION\_READ permission to invoke this API successfully.

##### Returns

GID1 content in hex format.

#### 4.11.1.1.2.11 virtual std::string telux::tel::ISubscription::getGID2 ( ) [pure virtual]

Retrieves the GID2(group identifier level2) content on the SIM. It represents identifier for particular SIM and ME associations. It can be used to identify a group of SIMs for a particular application. Defined in 3GPP Spec 131.102 section 4.2.11

On platforms with Access control enabled, Caller needs to have TELUX\_TEL\_SUBSCRIPTION\_READ permission to invoke this API successfully.

##### Returns

GID2 content in hex format.

### 4.11.1.2 class telux::tel::ISubscriptionListener

A listener class for receiving device subscription information. The methods in listener can be invoked from multiple different threads. The implementation should be thread safe.

#### Public member functions

- virtual void [onSubscriptionInfoChanged](#) (std::shared\_ptr< [ISubscription](#) > subscription)
- virtual void [onNumberOfSubscriptionsChanged](#) (int count)
- virtual [~ISubscriptionListener](#) ()

#### 4.11.1.2.1 Constructors and Destructors

##### 4.11.1.2.1.1 virtual telux::tel::ISubscriptionListener::~~ISubscriptionListener ( ) [virtual]

#### 4.11.1.2.2 Member Function Documentation

##### 4.11.1.2.2.1 virtual void telux::tel::ISubscriptionListener::onSubscriptionInfoChanged ( std::shared\_ptr< [ISubscription](#) > *subscription* ) [virtual]

This function is called whenever there is a change in Subscription details.

**Parameters**

in	<i>subscription</i>	Pointer to <a href="#">ISubscription</a> Object.
----	---------------------	--

#### 4.11.1.2.2.2 virtual void telux::tel::ISubscriptionListener::onNumberOfSubscriptionsChanged ( int *count* ) [virtual]

This function called whenever there is a change in the subscription count. for example when a new subscription is discovered or an existing subscription goes away when SIM is inserted or removed respectively.

**Parameters**

in	<i>count</i>	count of subscription
----	--------------	-----------------------

### 4.11.1.3 class telux::tel::ISubscriptionManager

**Public member functions**

- virtual bool [isSubsystemReady](#) ()=0
- virtual std::future< bool > [onSubsystemReady](#) ()=0
- virtual [telux::common::ServiceStatus](#) [getServiceStatus](#) ()=0
- virtual std::shared\_ptr< [ISubscription](#) > [getSubscription](#) (int slotId=DEFAULT\_SLOT\_ID, [telux::common::Status](#) \*status=nullptr)=0
- virtual std::vector< std::shared\_ptr< [ISubscription](#) > > [getAllSubscriptions](#) ([telux::common::Status](#) \*status=nullptr)=0
- virtual [telux::common::Status](#) [registerListener](#) (std::weak\_ptr< [ISubscriptionListener](#) > listener)=0
- virtual [telux::common::Status](#) [removeListener](#) (std::weak\_ptr< [ISubscriptionListener](#) > listener)=0
- virtual [~ISubscriptionManager](#) ()

#### 4.11.1.3.1 Constructors and Destructors

##### 4.11.1.3.1.1 virtual telux::tel::ISubscriptionManager::~~ISubscriptionManager ( ) [virtual]

#### 4.11.1.3.2 Member Function Documentation



**4.11.1.3.2.1 virtual bool telux::tel::ISubscriptionManager::isSubsystemReady ( ) [pure virtual]**

Checks the status of SubscriptionManager and returns the result.

**Returns**

If true then SubscriptionManager is ready for service.

**Deprecated**

Use [ISubscriptionManager::getServiceStatus\(\)](#) API.

**4.11.1.3.2.2 virtual std::future<bool> telux::tel::ISubscriptionManager::onSubsystemReady ( ) [pure virtual]**

Wait for Subscription subsystem to be ready.

**Returns**

A future that caller can wait on to be notified when SubscriptionManager is ready.

**Deprecated**

Use InitResponseCb in [PhoneFactory::getSubscriptionManager](#) instead, to get notified about subsystem readiness.

**4.11.1.3.2.3 virtual telux::common::ServiceStatus telux::tel::ISubscriptionManager::getServiceStatus ( ) [pure virtual]**

This status indicates whether the [ISubscriptionManager](#) object is in a usable state.

**Returns**

SERVICE\_AVAILABLE - If Subscription manager is ready for service. SERVICE\_UNAVAILABLE - If Subscription manager is temporarily unavailable. SERVICE\_FAILED - If Subscription manager encountered an irrecoverable failure.

**Note**

Eval: This is a new API and is being evaluated. It is subject to change and could break backwards compatibility.

**4.11.1.3.2.4 virtual std::shared\_ptr<ISubscription> telux::tel::ISubscriptionManager::getSubscription ( int slotId = DEFAULT\_SLOT\_ID, telux::common::Status \* status = nullptr ) [pure virtual]**

Get Subscription details of the SIM in the given SIM slot.

**Parameters**

in	<i>slotId</i>	Slot id corresponding to the subscription.
out	<i>status</i>	Status of getSubscription i.e. success or suitable status code.

**Returns**

Pointer to [ISubscription](#) object.

**4.11.1.3.2.5** `virtual std::vector<std::shared_ptr<ISubscription> > telux::tel::ISubscriptionManager::getAllSubscriptions ( telux::common::Status * status = nullptr ) [pure virtual]`

Get all the subscription details of the device.

**Parameters**

out	<i>status</i>	Status of getAllSubscriptions i.e. success or suitable status code.
-----	---------------	---

**Returns**

list of [ISubscription](#) objects.

**4.11.1.3.2.6** `virtual telux::common::Status telux::tel::ISubscriptionManager::registerListener ( std::weak_ptr< ISubscriptionListener > listener ) [pure virtual]`

Register a listener for Subscription events.

**Parameters**

in	<i>listener</i>	Pointer to <a href="#">ISubscriptionListener</a> object that processes the notification.
----	-----------------	--

**Returns**

Status of registerListener i.e. success or suitable status code.

**4.11.1.3.2.7** `virtual telux::common::Status telux::tel::ISubscriptionManager::removeListener ( std::weak_ptr< ISubscriptionListener > listener ) [pure virtual]`

Remove a previously added listener.

**Parameters**

in	<i>listener</i>	Pointer to <a href="#">ISubscriptionListener</a> object that needs to be removed.
----	-----------------	---

**Returns**

Status of removeListener i.e. success or suitable status code.

## 4.12 Network Selection

Network Selection Manager provides the interface to get and set network selection mode (Manual or Automatic), scan available networks and set and get preferred networks list.

### 4.12.1 Data Structure Documentation

#### 4.12.1.1 struct telux::tel::PreferredNetworkInfo

Defines the preferred network information

##### Data fields

Type	Field	Description
uint16_t	mcc	mobile country code
uint16_t	mnc	mobile network code
<a href="#">RatMask</a>	ratMask	bit mask denotes which of the radio access technologies are set

#### 4.12.1.2 struct telux::tel::OperatorStatus

Defines status of network operator

##### Data fields

Type	Field	Description
<a href="#">InUseStatus</a>	inUse	In-use status of network operator
<a href="#">RoamingStatus</a>	roaming	Roaming status of network operator
<a href="#">Forbidden↔ Status</a>	forbidden	Forbidden status of network operator
<a href="#">PreferredStatus</a>	preferred	Preferred status of network operator

#### 4.12.1.3 struct telux::tel::NetworkScanInfo

Defines Network scan information

##### Data fields

Type	Field	Description
<a href="#">NetworkScan↔ Type</a>	scanType	Network scan type
<a href="#">RatMask</a>	ratMask	Bit mask denotes which of the radio access technologies are set. ratMask is valid/set only when scanType is provided as <a href="#">NetworkScanType::USER_SPECIFIED_RAT</a>

#### 4.12.1.4 class telux::tel::INetworkSelectionManager

Network Selection Manager class provides the interface to get and set network selection mode, preferred network list and scan available networks.

**Public member functions**

- virtual bool [isSubsystemReady](#) ()=0
- virtual std::future< bool > [onSubsystemReady](#) ()=0
- virtual [telux::common::ServiceStatus](#) [getServiceStatus](#) ()=0
- virtual [telux::common::Status](#) [requestNetworkSelectionMode](#) ([SelectionModeResponseCallback](#) callback)=0
- virtual [telux::common::Status](#) [setNetworkSelectionMode](#) ([NetworkSelectionMode](#) selectMode, std::string mcc, std::string mnc, [common::ResponseCallback](#) callback=nullptr)=0
- virtual [telux::common::Status](#) [requestPreferredNetworks](#) ([PreferredNetworksCallback](#) callback)=0
- virtual [telux::common::Status](#) [setPreferredNetworks](#) (std::vector< [PreferredNetworkInfo](#) > preferredNetworksInfo, bool clearPrevious, [common::ResponseCallback](#) callback=nullptr)=0
- virtual [telux::common::Status](#) [performNetworkScan](#) ([NetworkScanCallback](#) callback)=0
- virtual [telux::common::Status](#) [performNetworkScan](#) ([NetworkScanInfo](#) info, [common::ResponseCallback](#) callback=nullptr)=0
- virtual [telux::common::Status](#) [registerListener](#) (std::weak\_ptr< [INetworkSelectionListener](#) > listener)=0
- virtual [telux::common::Status](#) [deregisterListener](#) (std::weak\_ptr< [INetworkSelectionListener](#) > listener)=0
- virtual [~INetworkSelectionManager](#) ()

**4.12.1.4.1 Constructors and Destructors**

**4.12.1.4.1.1** virtual [telux::tel::INetworkSelectionManager::~INetworkSelectionManager](#) ( )  
[virtual]

**4.12.1.4.2 Member Function Documentation**

**4.12.1.4.2.1** virtual bool [telux::tel::INetworkSelectionManager::isSubsystemReady](#) ( ) [pure virtual]

Checks the status of network subsystem and returns the result.

**Returns**

True if network subsystem is ready for service otherwise false.

**Deprecated**

Use [INetworkSelectionManager::getServiceStatus\(\)](#) API.

**4.12.1.4.2.2** `virtual std::future<bool> telux::tel::INetworkSelectionManager::onSubsystemReady ( )`  
`[pure virtual]`

Wait for network subsystem to be ready.

#### Returns

A future that caller can wait on to be notified when network subsystem is ready.

#### Deprecated

Use `InitResponseCb` in `PhoneFactory::getNetworkSelectionManager` instead, to get notified about subsystem readiness.

**4.12.1.4.2.3** `virtual telux::common::ServiceStatus telux::tel::INetworkSelectionManager::getService↔`  
`Status ( ) [pure virtual]`

This status indicates whether the `INetworkSelectionManager` object is in a usable state.

#### Returns

`SERVICE_AVAILABLE` - If Serving System manager is ready for service.

`SERVICE_UNAVAILABLE` - If Serving System manager is temporarily unavailable.

`SERVICE_FAILED` - If Serving System manager encountered an irrecoverable failure.

**4.12.1.4.2.4** `virtual telux::common::Status telux::tel::INetworkSelectionManager::request↔`  
`NetworkSelectionMode ( SelectionModeResponseCallback callback ) [pure`  
`virtual]`

Get current network selection mode (i.e Manual or Automatic) asynchronously.

On platforms with Access control enabled, Caller needs to have `TELUX_TEL_NETWORK_SELECTION_READ` permission to invoke this API successfully.

#### Parameters

<code>in</code>	<code>callback</code>	Callback function to get the response of get network selection mode request.
-----------------	-----------------------	--

#### Returns

Status of `requestNetworkSelectionMode` i.e. success or suitable error code.

**4.12.1.4.2.5** `virtual telux::common::Status telux::tel::INetworkSelectionManager::setNetwork↔`  
`SelectionMode ( NetworkSelectionMode selectMode, std::string mcc, std::string mnc,`  
`common::ResponseCallback callback = nullptr ) [pure virtual]`

Set current network selection mode and receive the response asynchronously.

On platforms with Access control enabled, Caller needs to have

TELUX\_TEL\_NETWORK\_SELECTION\_OPS permission to invoke this API successfully.

### Parameters

in	<i>selectMode</i>	Selection mode for a network i.e. automatic or manual. If selection mode is automatic then MCC and MNC are ignored. If it is manual, client has to explicitly pass MCC and MNC as arguments.
in	<i>callback</i>	Optional callback function to get the response of set network selection mode request.
in	<i>mcc</i>	Mobile Country Code (Applicable only for MANUAL selection mode).
in	<i>mnc</i>	Mobile Network Code (Applicable only for MANUAL selection mode).

### Returns

Status of setNetworkSelectionMode i.e. success or suitable error code.

#### 4.12.1.4.2.6 virtual telux::common::Status telux::tel::INetworkSelectionManager::requestPreferredNetworks ( PreferredNetworksCallback *callback* ) [pure virtual]

Get 3GPP preferred network list and static 3GPP preferred network list asynchronously. Higher priority networks appear first in the list. The networks that appear in the 3GPP Preferred Networks list get higher priority than the networks in the static 3GPP preferred networks list.

On platforms with Access control enabled, Caller needs to have TELUX\_TEL\_NETWORK\_SELECTION\_READ permission to invoke this API successfully.

### Parameters

in	<i>callback</i>	Callback function to get the response of get preferred networks request.
----	-----------------	--

### Returns

Status of requestPreferredNetworks i.e. success or suitable error code.

#### 4.12.1.4.2.7 virtual telux::common::Status telux::tel::INetworkSelectionManager::setPreferredNetworks ( std::vector< PreferredNetworkInfo > *preferredNetworksInfo*, bool *clearPrevious*, common::ResponseCallback *callback* = nullptr ) [pure virtual]

Set 3GPP preferred network list and receive the response asynchronously. It overrides the existing preferred network list. The preferred network list affects network selection selection when automatic registration is performed by the device. Higher priority networks should appear first in the list.

On platforms with Access control enabled, Caller needs to have TELUX\_TEL\_NETWORK\_SELECTION\_OPS permission to invoke this API successfully.

**Parameters**

in	<i>preferredNetworks↔ Info</i>	List of 3GPP preferred networks.
in	<i>clearPrevious</i>	If flag is false then new 3GPP preferred network list is appended to existing preferred network list. If flag is true then old list is flushed and new 3GPP preferred network list is added.
in	<i>callback</i>	Callback function to get the response of set preferred network list request.

**Returns**

Status of setPreferredNetworks i.e. success or suitable error code.

#### 4.12.1.4.2.8 virtual telux::common::Status telux::tel::INetworkSelectionManager::performNetworkScan ( NetworkScanCallback *callback* ) [pure virtual]

Perform the network scan and returns a list of available networks.

On platforms with Access control enabled, Caller needs to have TELUX\_TEL\_NETWORK\_SELECTION\_OPS permission to invoke this API successfully.

**Parameters**

in	<i>callback</i>	Callback function to get the response of perform network scan request
----	-----------------	---

**Returns**

Status of performNetworkScan i.e. success or suitable error code.

**Deprecated**

Use [INetworkSelectionManager::performNetworkScan\( common::ResponseCallback callback\)](#) API instead

#### 4.12.1.4.2.9 virtual telux::common::Status telux::tel::INetworkSelectionManager::performNetworkScan ( NetworkScanInfo *info*, common::ResponseCallback *callback* = nullptr ) [pure virtual]

Perform the network scan. The available networks list is returned incrementally as they become available, without waiting for the entire scan to complete through the indication API ([INetworkSelectionListener::onNetworkScanResults](#)). The scan status in indication will indicate if its a partial result or complete result.

On platforms with Access control enabled, Caller needs to have TELUX\_TEL\_NETWORK\_SELECTION\_OPS permission to invoke this API successfully.



**Parameters**

in	<i>info</i>	Provides network scan type and if the network scan type is user preferred RAT, includes RAT(s) information. <a href="#">NetworkScanInfo</a>
in	<i>callback</i>	Callback function to get the response of network scan request

**Returns**

Status of performNetworkScan i.e. success or suitable error code.

#### 4.12.1.4.2.10 virtual telux::common::Status telux::tel::INetworkSelectionManager::registerListener ( std::weak\_ptr< INetworkSelectionListener > *listener* ) [pure virtual]

Register a listener for specific updates from network access service.

**Parameters**

in	<i>listener</i>	Pointer of <a href="#">INetworkSelectionListener</a> object that processes the notification
----	-----------------	---

**Returns**

Status of registerListener i.e success or suitable status code.

#### 4.12.1.4.2.11 virtual telux::common::Status telux::tel::INetworkSelectionManager::deregisterListener ( std::weak\_ptr< INetworkSelectionListener > *listener* ) [pure virtual]

Deregister the previously added listener.

**Parameters**

in	<i>listener</i>	Previously registered <a href="#">INetworkSelectionListener</a> that needs to be removed
----	-----------------	--

**Returns**

Status of removeListener success or suitable status code

### 4.12.1.5 class telux::tel::OperatorInfo

Operator Info class provides operator name, MCC, MNC and network status.

**Public member functions**

- [OperatorInfo](#) (std::string networkName, std::string mcc, std::string mnc, [OperatorStatus](#) operatorStatus)
- [OperatorInfo](#) (std::string networkName, std::string mcc, std::string mnc, [RadioTechnology](#) rat, [OperatorStatus](#) operatorStatus)

- `std::string getName ()`
- `std::string getMcc ()`
- `std::string getMnc ()`
- [RadioTechnology](#) `getRat ()`
- [OperatorStatus](#) `getStatus ()`

#### 4.12.1.5.1 Constructors and Destructors

**4.12.1.5.1.1** `telux::tel::OperatorInfo::OperatorInfo ( std::string networkName, std::string mcc, std::string mnc, OperatorStatus operatorStatus )`

**4.12.1.5.1.2** `telux::tel::OperatorInfo::OperatorInfo ( std::string networkName, std::string mcc, std::string mnc, RadioTechnology rat, OperatorStatus operatorStatus )`

#### 4.12.1.5.2 Member Function Documentation

**4.12.1.5.2.1** `std::string telux::tel::OperatorInfo::getName ( )`

Get Operator name or description

##### Returns

Operator name.

**4.12.1.5.2.2** `std::string telux::tel::OperatorInfo::getMcc ( )`

Get mcc from the operator numeric.

##### Returns

MCC.

**4.12.1.5.2.3** `std::string telux::tel::OperatorInfo::getMnc ( )`

Get mnc from operator numeric.

##### Returns

MNC.

**4.12.1.5.2.4** [RadioTechnology](#) `telux::tel::OperatorInfo::getRat ( )`

Get radio access technology.

##### Returns

Radio access technology(RAT) [RadioTechnology](#).

#### 4.12.1.5.2.5 OperatorStatus telux::tel::OperatorInfo::getStatus ( )

Get status of operator.

#### Returns

status of the operator [OperatorStatus](#).

#### 4.12.1.6 class telux::tel::INetworkSelectionListener

Listener class for getting network selection mode change notification.

The methods in listener can be invoked from multiple different threads. Client needs to make sure that implementation is thread-safe.

#### Public member functions

- virtual void [onSelectionModeChanged](#) ([NetworkSelectionMode](#) mode)
- virtual void [onNetworkScanResults](#) ([NetworkScanStatus](#) scanStatus, std::vector<[telux::tel::OperatorInfo](#) > operatorInfos)
- virtual [~INetworkSelectionListener](#) ()

#### 4.12.1.6.1 Constructors and Destructors

##### 4.12.1.6.1.1 virtual telux::tel::INetworkSelectionListener::~~INetworkSelectionListener ( ) [virtual]

Destructor of [INetworkSelectionListener](#)

#### 4.12.1.6.2 Member Function Documentation

##### 4.12.1.6.2.1 virtual void telux::tel::INetworkSelectionListener::onSelectionModeChanged ( [NetworkSelectionMode](#) mode ) [virtual]

This function is called whenever network selection mode is changed.

On platforms with Access control enabled, Caller needs to have TELUX\_TEL\_NETWORK\_SELECTION\_READ permission to receive this notification.

#### Parameters

in	<i>mode</i>	Network selection mode <a href="#">NetworkSelectionMode</a>
----	-------------	---

##### 4.12.1.6.2.2 virtual void telux::tel::INetworkSelectionListener::onNetworkScanResults ( [NetworkScanStatus](#) scanStatus, std::vector< [telux::tel::OperatorInfo](#) > operatorInfos ) [virtual]

This function is called in response to performNetworkScan API. This API will be invoked multiple times in case of partial network scan results. In case of network scan failure and network scan completed this API

will not be invoked further.

### Parameters

in	<i>scanStatus</i>	Status of the network scan results <a href="#">NetworkScanStatus</a>
in	<i>operatorInfos</i>	Operators info with details of network operator name, MCC, MNC, etc. In case of partial network scan results, the operator info will have the information of the new set of operator info along with previous partial network scan results.

## 4.12.2 Enumeration Type Documentation

### 4.12.2.1 enum telux::tel::RatType

Defines network RAT type for preferred networks. Each value represents corresponding bit for RatMask bitset.

#### Enumerator

**UMTS** UMTS

**LTE** LTE

**LTE**

**GSM** GSM

**GSM**

**NR5G** NR5G

**NR5G**

### 4.12.2.2 enum telux::tel::NetworkScanStatus [strong]

Defines the status of the network scan results

#### Enumerator

**COMPLETE** Network scan is successful and completed. No more indications are expected for the scan request

**PARTIAL** Network scan results are partial, further results are expected in subsequent indication

**FAILED** Network scan failed either due to radio link failure or it is aborted or due to problem in performing incremental search.

### 4.12.2.3 enum telux::tel::NetworkSelectionMode [strong]

Defines network selection mode

#### Enumerator

**UNKNOWN** Unknown

**AUTOMATIC** Device registers according to provisioned mcc and mnc

**MANUAL** Device registers to specified network as per provided mcc and mnc

#### 4.12.2.4 enum telux::tel::InUseStatus [strong]

Defines in-use status of network operator

##### Enumerator

**UNKNOWN** Unknown  
**CURRENT\_SERVING** Current serving  
**AVAILABLE** Available

#### 4.12.2.5 enum telux::tel::RoamingStatus [strong]

Defines roaming status of network operator

##### Enumerator

**UNKNOWN** Unknown  
**HOME** Home  
**ROAM** Roaming

#### 4.12.2.6 enum telux::tel::ForbiddenStatus [strong]

Defines forbidden status of network operator

##### Enumerator

**UNKNOWN** Unknown  
**FORBIDDEN** Forbidden  
**NOT\_FORBIDDEN** Not forbidden

#### 4.12.2.7 enum telux::tel::PreferredStatus [strong]

Defines preferred status of network operator

##### Enumerator

**UNKNOWN** Unknown  
**PREFERRED** Preferred  
**NOT\_PREFERRED** Not preferred

#### 4.12.2.8 enum telux::tel::NetworkScanType [strong]

Defines Network scan type

##### Enumerator

**CURRENT\_RAT\_PREFERENCE** Network scan based on current RAT preference  
**USER\_SPECIFIED\_RAT** Network scan based on user specified RAT(s)  
**ALL\_RATS** Network scan on GSM/WCDMA/LTE/NR5G

## 4.13 Serving System

Serving System Manager class provides the interface to request and set service domain preference and radio access technology mode preference for searching and registering (CS/PS domain, RAT and operation mode)

### 4.13.1 Data Structure Documentation

#### 4.13.1.1 struct telux::tel::ServingSystemInfo

Defines current serving system information

##### Data fields

Type	Field	Description
<a href="#">Radio↔ Technology</a>	rat	Current serving RAT
<a href="#">ServiceDomain</a>	domain	Current service domain registered on system for the serving RAT

#### 4.13.1.2 struct telux::tel::RFBandInfo

Defines information of RF bands.

##### Data fields

Type	Field	Description
<a href="#">RFBand</a>	band	Currently active band
uint32_t	channel	Currently active channel
<a href="#">RFBandWidth</a>	bandWidth	Bandwidth information

#### 4.13.1.3 struct telux::tel::DcStatus

Defines Dual Connectivity status

##### Data fields

Type	Field	Description
<a href="#">Endc↔ Availability</a>	endc↔ Availability	ENDC availability
<a href="#">DcnrRestriction</a>	dcnrRestriction	DCNR restriction

#### 4.13.1.4 struct telux::tel::NetworkTimeInfo

Defines Network time information

##### Data fields

Type	Field	Description
uint16_t	year	Year.
uint8_t	month	Month. 1 is January and 12 is December.

Type	Field	Description
uint8_t	day	Day. Range: 1 to 31.
uint8_t	hour	Hour. Range: 0 to 23.
uint8_t	minute	Minute. Range: 0 to 59.
uint8_t	second	Second. Range: 0 to 59.
uint8_t	dayOfWeek	Day of the week. 0 is Monday and 6 is Sunday.
int8_t	timeZone	Offset between UTC and local time in units of 15 minutes (signed value). Actual value = field value * 15 minutes.
uint8_t	dstAdj	Daylight saving adjustment in hours to obtain local time. Possible values: 0, 1, and 2.
string	nitzTime	Network Identity and Time Zone(NITZ) information in the form "yyyy/mm/dd,hh:mm:ss(+/-)tzh:tzm,dt

#### 4.13.1.5 class telux::tel::IServingSystemManager

##### Public member functions

- virtual bool `isSubsystemReady ()=0`
- virtual `std::future< bool > onSubsystemReady ()=0`
- virtual `telux::common::ServiceStatus getServiceStatus ()=0`
- virtual `telux::common::Status setRatPreference (RatPreference ratPref, common::ResponseCallback callback=nullptr)=0`
- virtual `telux::common::Status requestRatPreference (RatPreferenceCallback callback)=0`
- virtual `telux::common::Status setServiceDomainPreference (ServiceDomainPreference serviceDomain, common::ResponseCallback callback=nullptr)=0`
- virtual `telux::common::Status requestServiceDomainPreference (ServiceDomainPreferenceCallback callback)=0`
- virtual `telux::common::Status getSystemInfo (ServingSystemInfo &sysInfo)=0`
- virtual `telux::tel::DcStatus getDcStatus ()=0`
- virtual `telux::common::Status requestNetworkTime (NetworkTimeResponseCallback callback)=0`
- virtual `telux::common::Status requestRFBandInfo (RFBandInfoCallback callback)=0`
- virtual `telux::common::Status registerListener (std::weak_ptr< IServingSystemListener > listener, ServingSystemNotificationMask mask=ALL_NOTIFICATIONS)=0`
- virtual `telux::common::Status deregisterListener (std::weak_ptr< IServingSystemListener > listener, ServingSystemNotificationMask mask=ALL_NOTIFICATIONS)=0`
- virtual `~IServingSystemManager ()`

##### Static Public Attributes

- static const `uint32_t ALL_NOTIFICATIONS = 0xFFFFFFFF`

#### 4.13.1.5.1 Constructors and Destructors

**4.13.1.5.1.1** `virtual telux::tel::IServingSystemManager::~~IServingSystemManager ( ) [virtual]`

Destructor of [IServingSystemManager](#)

#### 4.13.1.5.2 Member Function Documentation

**4.13.1.5.2.1** `virtual bool telux::tel::IServingSystemManager::isSubsystemReady ( ) [pure virtual]`

Checks the status of serving subsystem and returns the result.

##### Returns

True if serving subsystem is ready for service otherwise false.

##### Deprecated

Use [IServingSystemManager::getServiceStatus\(\)](#) API.

**4.13.1.5.2.2** `virtual std::future<bool> telux::tel::IServingSystemManager::onSubsystemReady ( ) [pure virtual]`

Wait for serving subsystem to be ready.

##### Returns

A future that caller can wait on to be notified when serving subsystem is ready.

##### Deprecated

Use `InitResponseCb` in [PhoneFactory::getServingSystemManager](#) instead, to get notified about subsystem readiness.

**4.13.1.5.2.3** `virtual telux::common::ServiceStatus telux::tel::IServingSystemManager::getServiceStatus ( ) [pure virtual]`

This status indicates whether the [IServingSystemManager](#) object is in a usable state.

##### Returns

`SERVICE_AVAILABLE` - If Serving System manager is ready for service.  
`SERVICE_UNAVAILABLE` - If Serving System manager is temporarily unavailable.  
`SERVICE_FAILED` - If Serving System manager encountered an irrecoverable failure.



**4.13.1.5.2.4 virtual telux::common::Status telux::tel::IServingSystemManager::setRatPreference ( RatPreference *ratPref*, common::ResponseCallback *callback = nullptr* ) [pure virtual]**

Set the preferred radio access technology mode that the device should use to acquire service.

On platforms with Access control enabled, Caller needs to have TELUX\_TEL\_SRV\_SYSTEM\_CONFIG permission to invoke this API successfully.

**Parameters**

in	<i>ratPref</i>	Radio access technology mode preference.
in	<i>callback</i>	Callback function to get the response of set RAT mode preference.

**Returns**

Status of setRatPreference i.e. success or suitable error code.

**4.13.1.5.2.5 virtual telux::common::Status telux::tel::IServingSystemManager::requestRatPreference ( RatPreferenceCallback *callback* ) [pure virtual]**

Request for preferred radio access technology mode.

On platforms with Access control enabled, Caller needs to have TELUX\_TEL\_SRV\_SYSTEM\_READ permission to invoke this API successfully.

**Parameters**

in	<i>callback</i>	Callback function to get the response of request preferred RAT mode.
----	-----------------	--

**Returns**

Status of requestRatPreference i.e. success or suitable error code.

**4.13.1.5.2.6 virtual telux::common::Status telux::tel::IServingSystemManager::setServiceDomain↔ Preference ( ServiceDomainPreference *serviceDomain*, common::ResponseCallback *callback = nullptr* ) [pure virtual]**

Initiate service domain preference like CS, PS or CS\_PS and receive the response asynchronously.

On platforms with Access control enabled, Caller needs to have TELUX\_TEL\_SRV\_SYSTEM\_CONFIG permission to invoke this API successfully.

**Parameters**

in	<i>serviceDomain</i>	<a href="#">ServiceDomainPreference</a> .
in	<i>callback</i>	Callback function to get the response of set service domain preference request.

**Returns**

Status of setServiceDomainPreference i.e. success or suitable error code.

#### 4.13.1.5.2.7 **virtual telux::common::Status telux::tel::IServingSystemManager::requestServiceDomainPreference ( ServiceDomainPreferenceCallback *callback* ) [pure virtual]**

Request for Service Domain Preference asynchronously.

On platforms with Access control enabled, Caller needs to have TELUX\_TEL\_SRV\_SYSTEM\_READ permission to invoke this API successfully.

**Parameters**

in	<i>callback</i>	Callback function to get the response of request service domain preference.
----	-----------------	---

**Returns**

Status of requestServiceDomainPreference i.e. success or suitable error code.

#### 4.13.1.5.2.8 **virtual telux::common::Status telux::tel::IServingSystemManager::getSystemInfo ( ServingSystemInfo & *sysInfo* ) [pure virtual]**

Get the Serving system information. Supports only 3GPP RATs.

On platforms with Access control enabled, Caller needs to have TELUX\_TEL\_SRV\_SYSTEM\_READ permission to invoke this API successfully.

**Parameters**

out	<i>sysInfo</i>	Serving system information <a href="#">ServingSystemInfo</a>
-----	----------------	--

**Returns**

Status of getServingSystemInfo i.e. success or suitable error code.

#### 4.13.1.5.2.9 **virtual telux::tel::DcStatus telux::tel::IServingSystemManager::getDcStatus ( ) [pure virtual]**

Request for Dual Connectivity status on 5G NR.

On platforms with Access control enabled, Caller needs to have TELUX\_TEL\_SRV\_SYSTEM\_READ permission to invoke this API successfully.

**Returns**

[DcStatus](#)

#### 4.13.1.5.2.10 **virtual telux::common::Status telux::tel::IServingSystemManager::requestNetworkTime ( NetworkTimeResponseCallback *callback* ) [pure virtual]**

Get network time information asynchronously.

On platforms with Access control enabled, Caller needs to have TELUX\_TEL\_SRV\_SYSTEM\_READ permission to invoke this API successfully.

##### Parameters

in	<i>callback</i>	Callback function to get the response of get network time information request.
----	-----------------	--

##### Returns

Status of requestNetworkTime i.e. success or suitable error code.

#### 4.13.1.5.2.11 **virtual telux::common::Status telux::tel::IServingSystemManager::requestRFBandInfo ( RFBandInfoCallback *callback* ) [pure virtual]**

Get the information about the band that the device is currently using.

On platforms with Access control enabled, Caller needs to have TELUX\_TEL\_SRV\_SYSTEM\_READ permission to invoke this API successfully.

##### Parameters

in	<i>callback</i>	Callback function to get the response of get RF band information request.
----	-----------------	---

##### Returns

Status of requestRFBandInfo i.e. success or suitable error code.

#### 4.13.1.5.2.12 **virtual telux::common::Status telux::tel::IServingSystemManager::registerListener ( std::weak\_ptr< IServingSystemListener > *listener*, ServingSystemNotificationMask *mask* = ALL\_NOTIFICATIONS ) [pure virtual]**

Register a listener for specific updates from serving system.

**Parameters**

in	<i>listener</i>	Pointer of <a href="#">IServingSystemListener</a> object that processes the notification
in	<i>mask</i>	Bit mask representing a set of notifications that needs to be registered - <a href="#">ServingSystemNotificationMask</a> Notifications under <a href="#">IServingSystemListener</a> that are not listed in in <a href="#">ServingSystemNotificationType</a> would always be registered by default. All the notifications will be registered when the client provides ALL_NOTIFICATIONS as input. The bits that are not set in the mask are ignored and do not have any effect on registration. To deregister, the API <a href="#">deregisterListener</a> should be used.

**Returns**

Status of registerListener i.e success or suitable status code.

**4.13.1.5.2.13** `virtual telux::common::Status telux::tel::IServingSystemManager::deregisterListener ( std::weak_ptr< IServingSystemListener > listener, ServingSystemNotificationMask mask = ALL_NOTIFICATIONS ) [pure virtual]`

Deregister the previously added listener.

**Parameters**

in	<i>listener</i>	Previously registered <a href="#">IServingSystemListener</a> that needs to be removed
in	<i>mask</i>	Bit mask that denotes a set of notifications that needs to be de-registered - <a href="#">ServingSystemNotificationMask</a> Notifications under <a href="#">IServingSystemListener</a> that are not listed in <a href="#">ServingSystemNotificationType</a> will be de-registered only when ALL_NOTIFICATIONS is provided as input. The bits that are not set in the mask are ignored and does not have any effect on de-registration. However, providing an empty mask is an invalid operation. To register again, the API <a href="#">registerListener</a> should be used.

**Returns**

Status of removeListener i.e. success or suitable status code

**4.13.1.5.3 Field Documentation**

**4.13.1.5.3.1** `const uint32_t telux::tel::IServingSystemManager::ALL_NOTIFICATIONS = 0xFFFFFFFF [static]`

Represents the set of all notifications defined in [ServingSystemNotificationType](#). When this constant value is provided for registration or deregistration, all notifications will be registered or deregistered.

### 4.13.1.6 class telux::tel::IServingSystemListener

Listener class for getting notifications related to updates in radio access technology mode preference, service domain preference, serving system information, etc. Some notifications in this listener could be frequent in nature. When the system is in a suspended/low power state, those indications will wake the system up. This could result in increased power consumption by the system. If those notifications are not required in the suspended/low power state, it is recommended for the client to de-register specific notifications using the deregisterListener API.

The listener method can be invoked from multiple different threads. Client needs to make sure that implementation is thread-safe.

#### Public member functions

- virtual void [onRatPreferenceChanged](#) ([RatPreference](#) preference)
- virtual void [onServiceDomainPreferenceChanged](#) ([ServiceDomainPreference](#) preference)
- virtual void [onSystemInfoChanged](#) ([ServingSystemInfo](#) sysInfo)
- virtual void [onDcStatusChanged](#) ([DcStatus](#) dcStatus)
- virtual void [onNetworkTimeChanged](#) ([NetworkTimeInfo](#) info)
- virtual void [onRFBandInfoChanged](#) ([RFBandInfo](#) bandInfo)
- virtual [~IServingSystemListener](#) ()

#### 4.13.1.6.1 Constructors and Destructors

**4.13.1.6.1.1** virtual telux::tel::IServingSystemListener::~~IServingSystemListener ( ) [virtual]

Destructor of [IServingSystemListener](#)

#### 4.13.1.6.2 Member Function Documentation

**4.13.1.6.2.1** virtual void telux::tel::IServingSystemListener::onRatPreferenceChanged ( [RatPreference](#) *preference* ) [virtual]

This function is called whenever RAT mode preference is changed.

On platforms with Access control enabled, Caller needs to have TELUX\_TEL\_SRV\_SYSTEM\_READ permission to receive this notification.

#### Parameters

in	<i>preference</i>	<a href="#">RatPreference</a>
----	-------------------	-------------------------------

#### 4.13.1.6.2.2 virtual void telux::tel::IServingSystemListener::onServiceDomainPreferenceChanged ( ServiceDomainPreference *preference* ) [virtual]

This function is called whenever service domain preference is changed.

On platforms with Access control enabled, Caller needs to have TELUX\_TEL\_SRV\_SYSTEM\_READ permission to receive this notification.

##### Parameters

in	<i>preference</i>	<a href="#">ServiceDomainPreference</a>
----	-------------------	---

#### 4.13.1.6.2.3 virtual void telux::tel::IServingSystemListener::onSystemInfoChanged ( ServingSystemInfo *sysInfo* ) [virtual]

This function is called whenever the Serving System information is changed. Supports only 3GPP RATs.

To receive this notification, client needs to register a listener using registerListener API by setting the ServingSystemNotificationType::SYSTEM\_INFO bit in the bitmask.

On platforms with Access control enabled, Caller needs to have TELUX\_TEL\_SRV\_SYSTEM\_READ permission to receive this notification.

##### Parameters

in	<i>sysInfo</i>	<a href="#">ServingSystemInfo</a>
----	----------------	-----------------------------------

#### 4.13.1.6.2.4 virtual void telux::tel::IServingSystemListener::onDcStatusChanged ( DcStatus *dcStatus* ) [virtual]

This function is called whenever the Dual Connectivity status is changed on 5G NR.

To receive this notification, client needs to register a listener using registerListener API by setting the ServingSystemNotificationType::SYSTEM\_INFO bit in the bitmask.

On platforms with Access control enabled, Caller needs to have TELUX\_TEL\_SRV\_SYSTEM\_READ permission to receive this notification.

##### Parameters

in	<i>dcStatus</i>	<a href="#">DcStatus</a>
----	-----------------	--------------------------

#### 4.13.1.6.2.5 virtual void telux::tel::IServingSystemListener::onNetworkTimeChanged ( NetworkTimeInfo *info* ) [virtual]

This function is called whenever network time information is changed.

On platforms with Access control enabled, Caller needs to have TELUX\_TEL\_SRV\_SYSTEM\_READ permission to receive this notification.

**Parameters**

in	<i>info</i>	Network time information <a href="#">NetworkTimeInfo</a>
----	-------------	--

#### 4.13.1.6.2.6 virtual void telux::tel::IServingSystemListener::onRFBandInfoChanged ( RFBandInfo *bandInfo* ) [virtual]

This function is called whenever the RF band information changes.

To receive this notification, client needs to register a listener using registerListener API by setting the ServingSystemNotificationType::RF\_BAND\_INFO bit in the bitmask.

On platforms with Access control enabled, Caller needs to have TELUX\_TEL\_SRV\_SYSTEM\_READ permission to receive this notification.

**Parameters**

in	<i>bandInfo</i>	<a href="#">RFBandInfo</a>
----	-----------------	----------------------------

## 4.13.2 Enumeration Type Documentation

### 4.13.2.1 enum telux::tel::ServiceDomainPreference [strong]

Defines service domain preference

**Enumerator**

**UNKNOWN**  
**CS\_ONLY** Circuit-switched only  
**PS\_ONLY** Packet-switched only  
**CS\_PS** Circuit-switched and packet-switched

### 4.13.2.2 enum telux::tel::ServiceDomain [strong]

Defines service domain

**Enumerator**

**UNKNOWN** Unknown, when the information is not available  
**NO\_SRV** No Service  
**CS\_ONLY** Circuit-switched only  
**PS\_ONLY** Packet-switched only  
**CS\_PS** Circuit-switched and packet-switched  
**CAMPED** Device camped on the network according to its provisioning, but not registered

### 4.13.2.3 enum telux::tel::RFBand [strong]

Defines RF Bands.

**Enumerator**

**INVALID**  
**BC\_0**  
**BC\_1**  
**BC\_3**  
**BC\_4**  
**BC\_5**  
**BC\_6**  
**BC\_7**  
**BC\_8**  
**BC\_9**  
**BC\_10**  
**BC\_11**  
**BC\_12**  
**BC\_13**  
**BC\_14**  
**BC\_15**  
**BC\_16**  
**BC\_17**  
**BC\_18**  
**BC\_19**  
**GSM\_450**  
**GSM\_480**  
**GSM\_750**  
**GSM\_850**  
**GSM\_900\_EXTENDED**  
**GSM\_900\_PRIMARY**  
**GSM\_900\_RAILWAYS**  
**GSM\_1800**  
**GSM\_1900**  
**WCDMA\_2100**  
**WCDMA\_PCS\_1900**  
**WCDMA\_DCS\_1800**  
**WCDMA\_1700\_US**  
**WCDMA\_850**  
**WCDMA\_800**  
**WCDMA\_2600**  
**WCDMA\_900**  
**WCDMA\_1700\_JAPAN**  
**WCDMA\_1500\_JAPAN**  
**WCDMA\_850\_JAPAN**  
**E\_UTRA\_OPERATING\_BAND\_1**  
**E\_UTRA\_OPERATING\_BAND\_2**  
**E\_UTRA\_OPERATING\_BAND\_3**  
**E\_UTRA\_OPERATING\_BAND\_4**  
**E\_UTRA\_OPERATING\_BAND\_5**  
**E\_UTRA\_OPERATING\_BAND\_6**  
**E\_UTRA\_OPERATING\_BAND\_7**  
**E\_UTRA\_OPERATING\_BAND\_8**  
**E\_UTRA\_OPERATING\_BAND\_9**



**E\_UTRA\_OPERATING\_BAND\_10**  
**E\_UTRA\_OPERATING\_BAND\_11**  
**E\_UTRA\_OPERATING\_BAND\_12**  
**E\_UTRA\_OPERATING\_BAND\_13**  
**E\_UTRA\_OPERATING\_BAND\_14**  
**E\_UTRA\_OPERATING\_BAND\_17**  
**E\_UTRA\_OPERATING\_BAND\_33**  
**E\_UTRA\_OPERATING\_BAND\_34**  
**E\_UTRA\_OPERATING\_BAND\_35**  
**E\_UTRA\_OPERATING\_BAND\_36**  
**E\_UTRA\_OPERATING\_BAND\_37**  
**E\_UTRA\_OPERATING\_BAND\_38**  
**E\_UTRA\_OPERATING\_BAND\_39**  
**E\_UTRA\_OPERATING\_BAND\_40**  
**E\_UTRA\_OPERATING\_BAND\_18**  
**E\_UTRA\_OPERATING\_BAND\_19**  
**E\_UTRA\_OPERATING\_BAND\_20**  
**E\_UTRA\_OPERATING\_BAND\_21**  
**E\_UTRA\_OPERATING\_BAND\_24**  
**E\_UTRA\_OPERATING\_BAND\_25**  
**E\_UTRA\_OPERATING\_BAND\_41**  
**E\_UTRA\_OPERATING\_BAND\_42**  
**E\_UTRA\_OPERATING\_BAND\_43**  
**E\_UTRA\_OPERATING\_BAND\_23**  
**E\_UTRA\_OPERATING\_BAND\_26**  
**E\_UTRA\_OPERATING\_BAND\_32**  
**E\_UTRA\_OPERATING\_BAND\_125**  
**E\_UTRA\_OPERATING\_BAND\_126**  
**E\_UTRA\_OPERATING\_BAND\_127**  
**E\_UTRA\_OPERATING\_BAND\_28**  
**E\_UTRA\_OPERATING\_BAND\_29**  
**E\_UTRA\_OPERATING\_BAND\_30**  
**E\_UTRA\_OPERATING\_BAND\_66**  
**E\_UTRA\_OPERATING\_BAND\_250**  
**E\_UTRA\_OPERATING\_BAND\_46**  
**E\_UTRA\_OPERATING\_BAND\_27**  
**E\_UTRA\_OPERATING\_BAND\_31**  
**E\_UTRA\_OPERATING\_BAND\_71**  
**E\_UTRA\_OPERATING\_BAND\_47**  
**E\_UTRA\_OPERATING\_BAND\_48**  
**E\_UTRA\_OPERATING\_BAND\_67**  
**E\_UTRA\_OPERATING\_BAND\_68**  
**E\_UTRA\_OPERATING\_BAND\_49**  
**E\_UTRA\_OPERATING\_BAND\_85**  
**E\_UTRA\_OPERATING\_BAND\_72**  
**E\_UTRA\_OPERATING\_BAND\_73**  
**E\_UTRA\_OPERATING\_BAND\_86**  
**E\_UTRA\_OPERATING\_BAND\_53**  
**E\_UTRA\_OPERATING\_BAND\_87**  
**E\_UTRA\_OPERATING\_BAND\_88**

**E\_UTRA\_OPERATING\_BAND\_70****TDSCDMA\_BAND\_A****TDSCDMA\_BAND\_B****TDSCDMA\_BAND\_C****TDSCDMA\_BAND\_D****TDSCDMA\_BAND\_E****TDSCDMA\_BAND\_F****NR5G\_BAND\_1****NR5G\_BAND\_2****NR5G\_BAND\_3****NR5G\_BAND\_5****NR5G\_BAND\_7****NR5G\_BAND\_8****NR5G\_BAND\_20****NR5G\_BAND\_28****NR5G\_BAND\_38****NR5G\_BAND\_41****NR5G\_BAND\_50****NR5G\_BAND\_51****NR5G\_BAND\_66****NR5G\_BAND\_70****NR5G\_BAND\_71****NR5G\_BAND\_74****NR5G\_BAND\_75****NR5G\_BAND\_76****NR5G\_BAND\_77****NR5G\_BAND\_78****NR5G\_BAND\_79****NR5G\_BAND\_80****NR5G\_BAND\_81****NR5G\_BAND\_82****NR5G\_BAND\_83****NR5G\_BAND\_84****NR5G\_BAND\_85****NR5G\_BAND\_257****NR5G\_BAND\_258****NR5G\_BAND\_259****NR5G\_BAND\_260****NR5G\_BAND\_261****NR5G\_BAND\_12****NR5G\_BAND\_25****NR5G\_BAND\_34****NR5G\_BAND\_39****NR5G\_BAND\_40****NR5G\_BAND\_65****NR5G\_BAND\_86****NR5G\_BAND\_48****NR5G\_BAND\_14****NR5G\_BAND\_13****NR5G\_BAND\_18**

**NR5G\_BAND\_26**  
**NR5G\_BAND\_30**  
**NR5G\_BAND\_29**  
**NR5G\_BAND\_53**  
**NR5G\_BAND\_46**  
**NR5G\_BAND\_91**  
**NR5G\_BAND\_92**  
**NR5G\_BAND\_93**  
**NR5G\_BAND\_94**

#### 4.13.2.4 enum telux::tel::RFBandWidth [strong]

Defines RF Bandwidth Information.

##### Enumerator

**INVALID\_BANDWIDTH** Invalid Value  
**LTE\_BW\_NRB\_6** LTE 1.4  
**LTE\_BW\_NRB\_15** LTE 3  
**LTE\_BW\_NRB\_25** LTE 5  
**LTE\_BW\_NRB\_50** LTE 10  
**LTE\_BW\_NRB\_75** LTE 15  
**LTE\_BW\_NRB\_100** LTE 20  
**NR5G\_BW\_NRB\_5** NR5G 5  
**NR5G\_BW\_NRB\_10** NR5G 10  
**NR5G\_BW\_NRB\_15** NR5G 15  
**NR5G\_BW\_NRB\_20** NR5G 20  
**NR5G\_BW\_NRB\_25** NR5G 25  
**NR5G\_BW\_NRB\_30** NR5G 30  
**NR5G\_BW\_NRB\_40** NR5G 40  
**NR5G\_BW\_NRB\_50** NR5G 50  
**NR5G\_BW\_NRB\_60** NR5G 60  
**NR5G\_BW\_NRB\_80** NR5G 80  
**NR5G\_BW\_NRB\_90** NR5G 90  
**NR5G\_BW\_NRB\_100** NR5G 100  
**NR5G\_BW\_NRB\_200** NR5G 200  
**NR5G\_BW\_NRB\_400** NR5G 400  
**GSM\_BW\_NRB\_2** GSM 0.2  
**TDSCDMA\_BW\_NRB\_2** TDSCDMA 1.6  
**WCDMA\_BW\_NRB\_5** WCDMA 5  
**WCDMA\_BW\_NRB\_10** WCDMA 10  
**NR5G\_BW\_NRB\_70** NR5G 70

#### 4.13.2.5 enum telux::tel::RatPrefType

Defines the radio access technology mode preference.

##### Enumerator

**PREF\_CDMA\_1X** CDMA\_1X  
**PREF\_CDMA\_EVDO** CDMA\_EVDO

**PREF\_GSM** GSM  
**PREF\_WCDMA** WCDMA  
**PREF\_LTE** LTE  
**PREF\_TDSCDMA** TDSCDMA  
**PREF\_NR5G** NR5G

#### 4.13.2.6 enum telux::tel::EndcAvailability [strong]

Defines ENDC(E-UTRAN New Radio-Dual Connectivity) Availability status on 5G NR

##### Enumerator

**UNKNOWN** Status unknown  
**AVAILABLE** ENDC is Available  
**UNAVAILABLE** ENDC is not Available

#### 4.13.2.7 enum telux::tel::DcnrRestriction [strong]

Defines DCNR(Dual Connectivity with NR) Restriction status on 5G NR

##### Enumerator

**UNKNOWN** Status unknown  
**RESTRICTED** DCNR is Rescticted  
**UNRESTRICTED** DCNR is not Restricted

#### 4.13.2.8 enum telux::tel::ServingSystemNotificationType

Defines some of the notifications supported by [IServingSystemListener](#) which can be dynamically disabled/enabled. Each entry represents one or more listener callbacks in [IServingSystemListener](#)

##### Enumerator

**SYSTEM\_INFO**  
**RF\_BAND\_INFO**

## 4.14 Remote SIM Provisioning

This section contains APIs related to Remote SIM provisioning.

### 4.14.1 Data Structure Documentation

#### 4.14.1.1 struct telux::tel::CustomHeader

Header information to be sent along with HTTP post request.

##### Data fields

Type	Field	Description
string	name	Header name
string	value	Header value

#### 4.14.1.2 class telux::tel::IHttpTransactionListener

The interface listens for indication to perform HTTP request and send back the response for HTTP request to modem.

The methods in the listener can be invoked from multiple threads. It is client's responsibility to make sure the implementation is thread safe.

##### Public member functions

- virtual void [onNewHttpRequest](#) (const std::string &url, uint32\_t tokenId, const std::vector< [CustomHeader](#) > &headers, const std::vector< uint8\_t > &reqPayload)
- virtual [~IHttpTransactionListener](#) ()

##### 4.14.1.2.1 Constructors and Destructors

4.14.1.2.1.1 virtual telux::tel::IHttpTransactionListener::~IHttpTransactionListener ( ) [[virtual](#)]

Destructor of [IHttpTransactionListener](#)

##### 4.14.1.2.2 Member Function Documentation

4.14.1.2.2.1 virtual void telux::tel::IHttpTransactionListener::onNewHttpRequest ( const std::string & url, uint32\_t tokenId, const std::vector< [CustomHeader](#) > & headers, const std::vector< uint8\_t > & reqPayload ) [[virtual](#)]

An application handling this indication should perform the HTTP request and call the [IHttpTransactionManager::sendHttpRequest](#) to provide the result of the HTTP transaction.

On platforms with access control enabled, the client needs to have `TELUX_TEL_SIM_PROFILE_HTTP_PROXY` permission to invoke this API successfully.

**Parameters**

in	<i>url</i>	URL to sent HTTP post request.
in	<i>tokenId</i>	Token identifier.
in	<i>headers</i>	Header information to be sent along with HTTP post request.
in	<i>reqPayload</i>	Request payload.

**4.14.1.3 class telux::tel::IHttpTransactionManager**

[IHttpTransactionManager](#) is the interface to service HTTP related requests from the modem for SIM profile update related operations.

**Public member functions**

- virtual [telux::common::ServiceStatus](#) [getServiceStatus](#) ()=0
- virtual [telux::common::Status](#) [sendHttpTransactionResult](#) (uint32\_t token, [HttpResult](#) result, const std::vector< [CustomHeader](#) > &headers, const std::vector< uint8\_t > &response, [common::ResponseCallback](#) callback=nullptr)=0
- virtual [telux::common::Status](#) [registerListener](#) (std::weak\_ptr< [IHttpTransactionListener](#) > listener)=0
- virtual [telux::common::Status](#) [deregisterListener](#) (std::weak\_ptr< [IHttpTransactionListener](#) > listener)=0
- virtual [~IHttpTransactionManager](#) ()

**4.14.1.3.1 Constructors and Destructors**

**4.14.1.3.1.1** virtual [telux::tel::IHttpTransactionManager::~IHttpTransactionManager](#) ( ) [**virtual**]

Destructor for [IHttpTransactionManager](#)

**4.14.1.3.2 Member Function Documentation**

**4.14.1.3.2.1** virtual [telux::common::ServiceStatus](#) [telux::tel::IHttpTransactionManager::getServiceStatus](#) ( ) [**pure virtual**]

This status indicates whether the [IHttpTransactionManager](#) object is in a usable state.

**Returns**

- SERVICE\_AVAILABLE - If HTTP transaction manager is ready for service.
- SERVICE\_UNAVAILABLE - If HTTP transaction manager is temporarily unavailable.
- SERVICE\_FAILED - If HTTP transaction manager encountered an irrecoverable failure.

**4.14.1.3.2.2** `virtual telux::common::Status telux::tel::IHttpTransactionManager::sendHttpTransaction(←  
Result ( uint32_t token, HttpRequest result, const std::vector< CustomHeader > &  
headers, const std::vector< uint8_t > & response, common::ResponseCallback callback  
= nullptr ) [pure virtual]`

Send the result of HTTP Post request transaction to modem.

On platforms with access control enabled, caller needs to have  
TELUX\_TEL\_SIM\_PROFILE\_HTTP\_PROXY permission to invoke this API successfully.

#### Parameters

in	<i>token</i>	Token identifier for request and response pair.
in	<i>result</i>	HTTP transaction request result.
in	<i>headers</i>	Custom Headers in HTTP Response.
in	<i>response</i>	HTTP response payload.
in	<i>callback</i>	Callback function to get the result of send HTTP transaction request.

#### Returns

Status of send HTTP transaction result i.e. success or suitable error code.

**4.14.1.3.2.3** `virtual telux::common::Status telux::tel::IHttpTransactionManager::registerListener (←  
std::weak_ptr< IHttpTransactionListener > listener ) [pure virtual]`

Register a listener for specific events like perform HTTP Post request.

#### Parameters

in	<i>listener</i>	Pointer of <a href="#">IHttpTransactionListener</a> object that processes the notification.
----	-----------------	---

#### Returns

Status of registerHttpListener success or suitable status code.

**4.14.1.3.2.4** `virtual telux::common::Status telux::tel::IHttpTransactionManager::deregisterListener (←  
std::weak_ptr< IHttpTransactionListener > listener ) [pure virtual]`

De-register the listener.

#### Parameters

in	<i>listener</i>	Pointer of <a href="#">IHttpTransactionListener</a> object that needs to be deregistered.
----	-----------------	---

#### Returns

Status of deregisterHttpListener success or suitable status code.

#### 4.14.1.4 class telux::tel::SimProfile

[SimProfile](#) class represents single eUICC profile on the card.

##### Public member functions

- [SimProfile](#) (int profileId, [ProfileType](#) profileType, const std::string &iccid, bool [isActive](#), const std::string &nickName, const std::string &spn, const std::string &name, [IconType](#) iconType, std::vector< uint8\_t > icon, [ProfileClass](#) profileClass, [PolicyRuleMask](#) policyRuleMask, int slotId=DEFAULT\_SLOT\_ID)
- int [getSlotId](#) ()
- int [getProfileId](#) ()
- [ProfileType](#) [getType](#) ()
- const std::string & [getIccid](#) ()
- bool [isActive](#) ()
- const std::string & [getNickName](#) ()
- const std::string & [getSPN](#) ()
- const std::string & [getName](#) ()
- [IconType](#) [getIconType](#) ()
- std::vector< uint8\_t > [getIcon](#) ()
- [ProfileClass](#) [getClass](#) ()
- [PolicyRuleMask](#) [getPolicyRule](#) ()
- std::string [toString](#) ()

##### 4.14.1.4.1 Constructors and Destructors

4.14.1.4.1.1 **telux::tel::SimProfile::SimProfile** ( int *profileId*, [ProfileType](#) *profileType*, const std::string & *iccid*, bool *isActive*, const std::string & *nickName*, const std::string & *spn*, const std::string & *name*, [IconType](#) *iconType*, std::vector< uint8\_t > *icon*, [ProfileClass](#) *profileClass*, [PolicyRuleMask](#) *policyRuleMask*, int *slotId* = *DEFAULT\_SLOT\_ID* )

##### 4.14.1.4.2 Member Function Documentation

4.14.1.4.2.1 int telux::tel::SimProfile::getSlotId ( )

Get slot id associated for this profile

##### Returns

SlotId



**4.14.1.4.2.2 int telux::tel::SimProfile::getProfileId ( )**

Get profile identifier. The profile identifier is not persistently unique. It is unique for given snapshot of SIM profiles state. The profile identifier could change when any profile is deleted and added.

**Returns**

unique identifier for the profile

**4.14.1.4.2.3 ProfileType telux::tel::SimProfile::getType ( )**

Get profile Type.

**Returns**

profile type

**4.14.1.4.2.4 const std::string& telux::tel::SimProfile::getIccid ( )**

Get profile ICCID.

**Returns**

profile ICCID coded as in EF-ICCID

**4.14.1.4.2.5 bool telux::tel::SimProfile::isActive ( )**

Indicates the profile state whether active or not.

**Returns**

true if profile is Active

**4.14.1.4.2.6 const std::string& telux::tel::SimProfile::getNickName ( )**

Get profile nick name.

**Returns**

profile nick name

**4.14.1.4.2.7 const std::string& telux::tel::SimProfile::getSPN ( )**

Get profile service provider name.

**Returns**

profile service provider name.

**4.14.1.4.2.8 const std::string& telux::tel::SimProfile::getName ( )**

Get profile name.

**Returns**

profile name

**4.14.1.4.2.9 IconType telux::tel::SimProfile::getIconType ( )**

Get profile icon type.

**Returns**

profile icon type

**4.14.1.4.2.10 std::vector<uint8\_t> telux::tel::SimProfile::getIcon ( )**

Get profile icon content.

**Returns**

profile icon content

**4.14.1.4.2.11 ProfileClass telux::tel::SimProfile::getClass ( )**

Get profile class.

**Returns**

profile class

**4.14.1.4.2.12 PolicyRuleMask telux::tel::SimProfile::getPolicyRule ( )**

Get profile policy rules.

**Returns**

mask of profile policy rules

**4.14.1.4.2.13 std::string telux::tel::SimProfile::toString ( )**

Get the text related informative representation of this object.

**Returns**

String containing informative string.

#### 4.14.1.5 class telux::tel::ISimProfileListener

The interface listens for profile download indication and keep track of download and install progress of profile.

The methods in the listener can be invoked from multiple threads. It is client's responsibility to make sure the implementation is thread safe.

##### Public member functions

- virtual void [onDownloadStatus](#) (SlotId slotId, [DownloadStatus](#) status, [DownloadErrorCause](#) cause)
- virtual void [onUserDisplayInfo](#) (SlotId slotId, bool userConsentRequired, [PolicyRuleMask](#) mask)
- virtual void [onConfirmationCodeRequired](#) (SlotId slotId, std::string profileName)
- virtual [~ISimProfileListener](#) ()

#### 4.14.1.5.1 Constructors and Destructors

4.14.1.5.1.1 virtual telux::tel::ISimProfileListener::~~ISimProfileListener ( ) [virtual]

Destructor of [ISimProfileListener](#)

#### 4.14.1.5.2 Member Function Documentation

4.14.1.5.2.1 virtual void telux::tel::ISimProfileListener::onDownloadStatus ( SlotId *slotId*, [DownloadStatus](#) *status*, [DownloadErrorCause](#) *cause* ) [virtual]

This function is called when indication about status of profile download and installation comes.

On platforms with access control enabled, the client needs to have TELUX\_TEL\_SIM\_PROFILE\_OPS permission to invoke this API successfully.

##### Parameters

in	<i>slotId</i>	Slot on which profile get downloaded and installed.
in	<i>status</i>	<a href="#">telux::tel::DownloadStatus</a> .
in	<i>cause</i>	<a href="#">telux::tel::DownloadErrorCause</a> .

4.14.1.5.2.2 virtual void telux::tel::ISimProfileListener::onUserDisplayInfo ( SlotId *slotId*, bool *userConsentRequired*, [PolicyRuleMask](#) *mask* ) [virtual]

This function is invoked when information about user consent and profile policy rules is received. The client application is expected to provide user consent for download and install profile by calling [telux::tel::ISimProfileManager::provideUserConsent](#) if user consent is expected.

On platforms with access control enabled, the client needs to have TELUX\_TEL\_SIM\_PROFILE\_OPS permission to invoke this API successfully.

**Parameters**

in	<i>slotId</i>	Slot on which profile get downloaded and installed.
in	<i>userConsent↔ Required</i>	User consent required or not. If true it means user is expected to provide consent for download and install.
in	<i>mask</i>	<a href="#">telux::tel::PolicyRuleMask</a> (Profile policy rules Mask)

#### 4.14.1.5.2.3 virtual void telux::tel::ISimProfileListener::onConfirmationCodeRequired ( SlotId *slotId*, std::string *profileName* ) [virtual]

This function is invoked when confirmation code is required. The client application is expected to provide confirmation code for download and install profile by calling [telux::tel::ISimProfileManager::provideConfirmationCode](#).

On platforms with access control enabled, the client needs to have TELUX\_TEL\_SIM\_PROFILE\_OPS permission to invoke this API successfully.

**Parameters**

in	<i>slotId</i>	Slot on which profile get downloaded and installed.
in	<i>profileName</i>	Profile name corresponding to which confirmation code is required.

#### 4.14.1.6 class telux::tel::ISimProfileManager

[ISimProfileManager](#) is a primary interface for remote eUICCs (eSIMs or embedded SIMs) provisioning. This interface provides APIs to add, delete, set profile, update nickname, provide user consent, get Eid on the eUICC.

**Public member functions**

- virtual bool [isSubsystemReady](#) ()=0
- virtual std::future< bool > [onSubsystemReady](#) ()=0
- virtual [telux::common::ServiceStatus](#) [getServiceStatus](#) ()=0
- virtual [telux::common::Status](#) [addProfile](#) (SlotId slotId, const std::string &activationCode, const std::string &confirmationCode="", bool userConsentSupported=false, [common::ResponseCallback](#) callback=nullptr)=0
- virtual [telux::common::Status](#) [deleteProfile](#) (SlotId slotId, int profileId, [common::ResponseCallback](#) callback=nullptr)=0
- virtual [telux::common::Status](#) [setProfile](#) (SlotId slotId, int profileId, bool enable=false, [common::ResponseCallback](#) callback=nullptr)=0
- virtual [telux::common::Status](#) [updateNickName](#) (SlotId slotId, int profileId, const std::string &nickName, [common::ResponseCallback](#) callback=nullptr)=0
- virtual [telux::common::Status](#) [requestProfileList](#) (SlotId slotId, [ProfileListResponseCb](#) callback)=0
- virtual [telux::common::Status](#) [requestEid](#) (SlotId slotId, [EidResponseCb](#) callback)=0

- virtual [telux::common::Status provideUserConsent](#) (SlotId slotId, bool userConsent, [UserConsentReasonType](#) reason, [common::ResponseCallback](#) callback=nullptr)=0
- virtual [telux::common::Status provideConfirmationCode](#) (SlotId slotId, std::string code, [common::ResponseCallback](#) callback=nullptr)=0
- virtual [telux::common::Status requestServerAddress](#) (SlotId slotId, [ServerAddressResponseCb](#) callback)=0
- virtual [telux::common::Status setServerAddress](#) (SlotId slotId, const std::string &smdpAddress, [common::ResponseCallback](#) callback=nullptr)=0
- virtual [telux::common::Status memoryReset](#) (SlotId slotId, [ResetOptionMask](#) mask, [common::ResponseCallback](#) callback=nullptr)=0
- virtual [telux::common::Status registerListener](#) (std::weak\_ptr< [ISimProfileListener](#) > listener)=0
- virtual [telux::common::Status deregisterListener](#) (std::weak\_ptr< [ISimProfileListener](#) > listener)=0
- virtual [~ISimProfileManager](#) ()

#### 4.14.1.6.1 Constructors and Destructors

4.14.1.6.1.1 `virtual telux::tel::ISimProfileManager::~~ISimProfileManager ( ) [virtual]`

Destructor for [ISimProfileManager](#)

#### 4.14.1.6.2 Member Function Documentation

4.14.1.6.2.1 `virtual bool telux::tel::ISimProfileManager::isSubsystemReady ( ) [pure virtual]`

Checks if the eUICC subsystem is ready.

#### Deprecated

Use [ISimProfileManager::getServiceStatus\(\)](#) API.

#### Returns

True if [ISimProfileManager](#) is ready for service, otherwise returns false.

#### 4.14.1.6.2.2 `virtual std::future<bool> telux::tel::ISimProfileManager::onSubsystemReady ( ) [pure virtual]`

Wait for eUICC subsystem to be ready.

#### Deprecated

Use `InitResponseCb` in `PhoneFactory::getSimProfileManager` instead, to get notified about subsystem readiness.

#### Returns

A future that caller can wait on to be notified when card manager is ready.

#### 4.14.1.6.2.3 `virtual telux::common::ServiceStatus telux::tel::ISimProfileManager::getServiceStatus ( ) [pure virtual]`

This status indicates whether the `ISimProfileManager` object is in a usable state.

#### Returns

`SERVICE_AVAILABLE` - If `SimProfile` Manager is ready for service. `SERVICE_UNAVAILABLE` - If `SimProfile` Manager is temporarily unavailable. `SERVICE_FAILED` - If `SimProfile` Manager encountered an irrecoverable failure.

#### Note

Eval: This is a new API and is being evaluated. It is subject to change and could break backwards compatibility.

#### 4.14.1.6.2.4 `virtual telux::common::Status telux::tel::ISimProfileManager::addProfile ( SlotId slotId, const std::string & activationCode, const std::string & confirmationCode = "", bool userConsentSupported = false, common::ResponseCallback callback = nullptr ) [pure virtual]`

Add new profile to eUICC card and download and install the profile on eUICC.

On platforms with access control enabled, caller needs to have `TELUX_TEL_SIM_PROFILE_OPS` permission to invoke this API successfully.

#### Parameters

in	<i>slotId</i>	Slot identifier corresponding to the card.
in	<i>activationCode</i>	Activation code.
in	<i>confirmationCode</i>	Optional confirmation code required for downloading the profile.
in	<i>userConsentSupported</i>	Optional User consent supported or not.
in	<i>callback</i>	Optional callback function to get the result of add profile.

## Returns

Status of add profile i.e. success or suitable error code.

### 4.14.1.6.2.5 virtual telux::common::Status telux::tel::ISimProfileManager::deleteProfile ( SlotId *slotId*, int *profileId*, common::ResponseCallback *callback* = *nullptr* ) [pure virtual]

Delete profile from eUICC card.

1. Deletion of enabled profile a) This API will disable the profile first and then delete it. b) The profile is associated with profile policy rules (PPRs) so before disabling the profile, this API checks if the PPRs [telux::tel::PolicyRuleType](#) allow the operation. c) If the policy rules are not set, then first disabling of profile happens followed by deletion of profile. d) If disable succeeds but deletion fails, then the API attempts to roll back the profile back to the original (enabled) state. e) If rollback fails due to any reason such as eUICC being in incompatible state then the profile will be in disabled state and the API will return [telux::common::ErrorCode::ROLLBACK\\_FAILED](#)
2. Deletion of disabled profile a) This API checks the PPR [telux::tel::PolicyRuleType::PROFILE\\_DELETE\\_NOT\\_ALLOWED](#) before deletion of profile. b) If the PPR is not set, then deletion of profile is performed. If the PPR is set, then the API returns [telux::common::ErrorCode::OPERATION\\_NOT\\_ALLOWED](#).

On platforms with access control enabled, caller needs to have TELUX\_TEL\_SIM\_PROFILE\_OPS permission to invoke this API successfully.

## Parameters

in	<i>slotId</i>	Slot identifier corresponding to the card.
in	<i>profileId</i>	Profile identifier
in	<i>callback</i>	Optional callback function to get the result of delete profile.

## Returns

Status of delete profile i.e. success or suitable error code.

### 4.14.1.6.2.6 virtual telux::common::Status telux::tel::ISimProfileManager::setProfile ( SlotId *slotId*, int *profileId*, bool *enable* = *false*, common::ResponseCallback *callback* = *nullptr* ) [pure virtual]

Enable or disable profile which allows to switch to other profile on eUICC card.

On platforms with access control enabled, caller needs to have TELUX\_TEL\_SIM\_PROFILE\_OPS permission to invoke this API successfully.

## Parameters

in	<i>slotId</i>	Slot identifier corresponding to the card.
in	<i>profileId</i>	Profile identifier.
in	<i>enable</i>	Indicates whether a profile must be enabled or disabled. true - Enable and false - Disable.
in	<i>callback</i>	Optional callback function to get the result of set profile.

**Returns**

Status of set profile i.e. success or suitable error code.

**4.14.1.6.2.7** `virtual telux::common::Status telux::tel::ISimProfileManager::updateNickName ( SlotId slotId, int profileId, const std::string & nickName, common::ResponseCallback callback = nullptr ) [pure virtual]`

Update nick name of the profile.

On platforms with access control enabled, caller needs to have TELUX\_TEL\_SIM\_PROFILE\_OPS permission to invoke this API successfully.

**Parameters**

in	<i>slotId</i>	Slot identifier corresponding to the card.
in	<i>profileId</i>	Profile identifier
in	<i>nickName</i>	New nick name for profile.
in	<i>callback</i>	Optional callback function to get the result of update nickname.

**Returns**

Status of update nick name i.e. success or suitable error code.

**4.14.1.6.2.8** `virtual telux::common::Status telux::tel::ISimProfileManager::requestProfileList ( SlotId slotId, ProfileListResponseCb callback ) [pure virtual]`

Request list of profiles supported by the eUICC card.

On platforms with access control enabled, caller needs to have TELUX\_TEL\_SIM\_PROFILE\_READ permission to invoke this API successfully.

**Parameters**

in	<i>slotId</i>	Slot identifier corresponding to the card.
in	<i>callback</i>	Callback function to get the result of request profile list.

**Returns**

Status of request profile list i.e. success or suitable error code.

**4.14.1.6.2.9** `virtual telux::common::Status telux::tel::ISimProfileManager::requestEid ( SlotId slotId, EidResponseCb callback ) [pure virtual]`

Request eUICC identifier(EID) for the slot.

On platforms with access control enabled, caller needs to have TELUX\_TEL\_SIM\_PROFILE\_READ permission to invoke this API successfully.



**Parameters**

in	<i>slotId</i>	Slot identifier corresponding to the card.
in	<i>callback</i>	Callback function to get the result of request EID.

**Returns**

Status of request EID i.e. success or suitable error code.

**Deprecated**

Use [telux::tel::ICard::requestEid](#) API instead

**4.14.1.6.2.10** `virtual telux::common::Status telux::tel::ISimProfileManager::provideUserConsent ( SlotId slotId, bool userConsent, UserConsentReasonType reason, common::ResponseCallback callback = nullptr ) [pure virtual]`

Provide user consent required for downloading and installing profile. This API should be called in response to [telux::tel::ISimProfileListener::onUserDisplayInfo](#).

On platforms with access control enabled, caller needs to have TELUX\_TEL\_SIM\_PROFILE\_USER\_CONSENT permission to invoke this API successfully.

**Parameters**

in	<i>slotId</i>	Slot identifier corresponding to the card.
in	<i>userConsent</i>	Consent for profile download and install. True means user consent given to download and install.
in	<i>reason</i>	Reason for not providing user consent to download and install. <a href="#">telux::tel::UserConsentReasonType</a>
in	<i>callback</i>	Optional callback function to get the result of user consent request.

**Returns**

Status of user consent request i.e. success or suitable error code.

**4.14.1.6.2.11** `virtual telux::common::Status telux::tel::ISimProfileManager::provideConfirmationCode ( SlotId slotId, std::string code, common::ResponseCallback callback = nullptr ) [pure virtual]`

Provide confirmation code required for downloading and installing profile. This API should be called in response to [telux::tel::ISimProfileListener::onConfirmationCodeRequired](#).

On platforms with access control enabled, caller needs to have TELUX\_TEL\_SIM\_PROFILE\_OPS permission to invoke this API successfully.

**Parameters**

in	<i>slotId</i>	Slot identifier corresponding to the card.
----	---------------	--

in	<i>code</i>	Confirmation code for profile download and install.
in	<i>callback</i>	Optional callback function to get the result of confirmation request.

### Returns

Status of provide confirmation code i.e. success or suitable error code.

#### 4.14.1.6.2.12 **virtual telux::common::Status telux::tel::ISimProfileManager::requestServerAddress ( SlotId *slotId*, ServerAddressResponseCb *callback* ) [pure virtual]**

Get Subscription Manager Data Preparation (SM-DP+) address and the Subscription Manager Discovery Server (SMDS) address configured on the eUICC.

On platforms with access control enabled, caller needs to have TELUX\_TEL\_SIM\_PROFILE\_READ permission to invoke this API successfully.

### Parameters

in	<i>slotId</i>	Slot identifier corresponding to the card.
in	<i>callback</i>	Callback function to get the result of server address request.

### Returns

Status of server address request i.e. success or suitable error code.

#### 4.14.1.6.2.13 **virtual telux::common::Status telux::tel::ISimProfileManager::setServerAddress ( SlotId *slotId*, const std::string & *smdpAddress*, common::ResponseCallback *callback* = nullptr ) [pure virtual]**

Set Subscription Manager Data Preparation (SM-DP+) address on the eUICC. If SMDP+ address length is zero then the existing SM-DP+ address on the eUICC is removed.

On platforms with access control enabled, caller needs to have TELUX\_TEL\_SIM\_PROFILE\_CONFIG permission to invoke this API successfully.

### Parameters

in	<i>slotId</i>	Slot identifier corresponding to the card.
in	<i>smdpAddress</i>	SM-DP+ address to be configured on the eUICC.
in	<i>callback</i>	Optional Callback function to get the result of set SM-DP+ request.

### Returns

Status of set server address request i.e. success or suitable error code.

**4.14.1.6.2.14** `virtual telux::common::Status telux::tel::ISimProfileManager::memoryReset ( SlotId slotId, ResetOptionMask mask, common::ResponseCallback callback = nullptr ) [pure virtual]`

Resets the memory of the eUICC card based on [telux::tel::ResetOptionMask](#).

On platforms with access control enabled, caller needs to have TELUX\_TEL\_SIM\_PROFILE\_OPS permission to invoke this API successfully.

#### Parameters

in	<i>slotId</i>	Slot identifier corresponding to the card.
in	<i>mask</i>	Memory reset options mask <a href="#">telux::tel::ResetOptionMask</a>
in	<i>callback</i>	Optional Callback function to get the result of memory reset request.

#### Returns

Status of memory reset request i.e. success or suitable error code.

**4.14.1.6.2.15** `virtual telux::common::Status telux::tel::ISimProfileManager::registerListener ( std::weak_ptr< ISimProfileListener > listener ) [pure virtual]`

Register a listener to listen for status of specific events like download and installation of profile on eUICC.

#### Parameters

in	<i>listener</i>	Pointer of <a href="#">ISimProfileListener</a> object that processes the notification.
----	-----------------	--

#### Returns

Status of registerListener success or suitable status code

**4.14.1.6.2.16** `virtual telux::common::Status telux::tel::ISimProfileManager::deregisterListener ( std::weak_ptr< ISimProfileListener > listener ) [pure virtual]`

De-register the listener.

#### Parameters

in	<i>listener</i>	Pointer of <a href="#">ISimProfileListener</a> object that needs to be removed
----	-----------------	--

#### Returns

Status of deregisterListener success or suitable status code

## 4.14.2 Enumeration Type Documentation

### 4.14.2.1 enum telux::tel::HttpResult [strong]

Defines the HTTP request result.

#### Enumerator

**TRANSACTION\_SUCCESSFUL** HTTP request successful

**UNKNOWN\_ERROR** Unknown error

**HTTP\_SERVER\_ERROR** Server error

**HTTP\_TLS\_ERROR** TLS error

**HTTP\_NETWORK\_ERROR** Network error

### 4.14.2.2 enum telux::tel::ProfileType [strong]

Indicates profile type of card

#### Enumerator

**UNKNOWN**

**REGULAR** Regular profile

**EMERGENCY** Emergency profile

### 4.14.2.3 enum telux::tel::IconType [strong]

Indicates profile icon type.

#### Enumerator

**NONE** No icon information

**JPEG** JPEG icon

**PNG** PNG icon

### 4.14.2.4 enum telux::tel::ProfileClass [strong]

Indicates profile class.

#### Enumerator

**UNKNOWN** No info about profile class

**TEST** Test profile

**PROVISIONING** Provisioning profile

**OPERATIONAL** Operational profile

#### 4.14.2.5 enum telux::tel::DownloadStatus [strong]

Indicates profile download status.

##### Enumerator

**DOWNLOAD\_ERROR** Profile download error

**DOWNLOAD\_INSTALLATION\_COMPLETE** Profile download and installation is complete

#### 4.14.2.6 enum telux::tel::DownloadErrorCause [strong]

Indicates profile download error cause.

##### Enumerator

**GENERIC** Generic error

**SIM** Error from the SIM card

**NETWORK** Error from the network

**MEMORY** Error due to no memory

**UNSUPPORTED\_PROFILE\_CLASS** Unsupported profile class

**PPR\_NOT\_ALLOWED** Profile policy rules not allowed

**END\_USER\_REJECTION** End user rejection

**END\_USER\_POSTPONED** End user postponed

#### 4.14.2.7 enum telux::tel::UserConsentReasonType [strong]

Indicates the reason for user consent not provided.

##### Enumerator

**END\_USER\_REJECTION** End user rejection

**END\_USER\_POSTPONED** End user postponed

#### 4.14.2.8 enum telux::tel::PolicyRuleType

Defines profile policy rules(PPR). Each value represents corresponding bit for PprMask bitset.

##### Enumerator

**PROFILE\_DISABLE\_NOT\_ALLOWED** Disabling of the profile is not allowed

**PROFILE\_DELETE\_NOT\_ALLOWED** Deletion of the profile is not allowed

**PROFILE\_DELETE\_ON\_DISABLE** Deletion of the profile is required on successful disabling

#### 4.14.2.9 enum telux::tel::ResetOption

Defines memory reset options. Each value represents corresponding bit for ResetOptionMask bitset.

##### Enumerator

**TEST\_PROFILES** Delete all the test profiles

**OPERATIONAL\_PROFILE** Delete all operational profiles

**DEFAULT\_SMDP\_ADDRESS** Reset the default SM-DP+ address

## 4.15 Remote SIM

This section contains APIs related to Remote SIM operations.

### 4.15.1 Data Structure Documentation

#### 4.15.1.1 class telux::tel::IRemoteSimListener

A listener class for getting remote SIM notifications.

The methods in listener can be invoked from multiple different threads. The implementation should be thread safe.

#### Public member functions

- virtual void [onAduTransfer](#) (const unsigned int id, const std::vector< uint8\_t > &apdu)
- virtual void [onCardConnect](#) ()
- virtual void [onCardDisconnect](#) ()
- virtual void [onCardPowerUp](#) ()
- virtual void [onCardPowerDown](#) ()
- virtual void [onCardReset](#) ()
- virtual [~IRemoteSimListener](#) ()

#### 4.15.1.1.1 Constructors and Destructors

4.15.1.1.1.1 virtual telux::tel::IRemoteSimListener::~~IRemoteSimListener ( ) [virtual]

Destructor of [IRemoteSimListener](#)

#### 4.15.1.1.2 Member Function Documentation

4.15.1.1.2.1 virtual void telux::tel::IRemoteSimListener::onAduTransfer ( const unsigned int *id*, const std::vector< uint8\_t > & *apdu* ) [virtual]

This function is called when the modem wants to transmit a command APDU.

#### Parameters

in	<i>id</i>	Identifier for a command and response APDU pair
in	<i>apdu</i>	APDU request sent to the control point (max size = 261, per ETSI TS 102 221, section 10.1.4)

4.15.1.1.2.2 virtual void telux::tel::IRemoteSimListener::onCardConnect ( ) [virtual]

This function is called when the modem wants to establish a connection.

**4.15.1.1.2.3 virtual void telux::tel::IRemoteSimListener::onCardDisconnect ( ) [virtual]**

This function is called when the modem wants to tear down a connection.

**4.15.1.1.2.4 virtual void telux::tel::IRemoteSimListener::onCardPowerUp ( ) [virtual]**

This function is called when the modem wants to power up the card.

**4.15.1.1.2.5 virtual void telux::tel::IRemoteSimListener::onCardPowerDown ( ) [virtual]**

This function is called when the modem wants to power down the card.

**4.15.1.1.2.6 virtual void telux::tel::IRemoteSimListener::onCardReset ( ) [virtual]**

This function is called when the modem wants to warm reset the card.

**4.15.1.2 class telux::tel::IRemoteSimManager**

[IRemoteSimManager](#) provides APIs for remote SIM related operations. This allows a device to use a SIM card on another device for its WWAN modem functionality. The SIM provider service is the endpoint that interfaces with the SIM card (e.g. over bluetooth) and sends/receives data to the other endpoint, the modem. The modem sends requests to the SIM provider service to interact with the SIM card (e.g. power up, transmit APDU, etc.), and is notified of events (e.g. card errors, resets, etc.). This API is used by the SIM provider endpoint to provide a SIM card to the modem.

**Public member functions**

- virtual bool [isSubsystemReady](#) ()=0
- virtual std::future< bool > [onSubsystemReady](#) ()=0
- virtual [telux::common::ServiceStatus](#) [getServiceStatus](#) ()=0
- virtual [telux::common::Status](#) [sendReset](#) ([telux::common::ResponseCallback](#) callback=nullptr)=0
- virtual [telux::common::Status](#) [sendConnectionAvailable](#) ([telux::common::ResponseCallback](#) callback=nullptr)=0
- virtual [telux::common::Status](#) [sendConnectionUnavailable](#) ([telux::common::ResponseCallback](#) callback=nullptr)=0
- virtual [telux::common::Status](#) [sendCardReset](#) (const std::vector< uint8\_t > &atr, [telux::common::ResponseCallback](#) callback=nullptr)=0
- virtual [telux::common::Status](#) [sendCardError](#) (const [CardErrorCause](#) cause=[CardErrorCause::INVALID](#), [telux::common::ResponseCallback](#) callback=nullptr)=0
- virtual [telux::common::Status](#) [sendCardInserted](#) (const std::vector< uint8\_t > &atr, [telux::common::ResponseCallback](#) callback=nullptr)=0
- virtual [telux::common::Status](#) [sendCardRemoved](#) ([telux::common::ResponseCallback](#) callback=nullptr)=0
- virtual [telux::common::Status](#) [sendCardWakeup](#) ([telux::common::ResponseCallback](#)

callback=nullptr)=0

- virtual [telux::common::Status sendApdu](#) (const unsigned int id, const std::vector< uint8\_t > &apdu, const bool isSuccess=true, const unsigned int totalSize=0, const unsigned int offset=0, [telux::common::ResponseCallback](#) callback=nullptr)=0
- virtual [telux::common::Status registerListener](#) (std::weak\_ptr< [IRemoteSimListener](#) > listener)=0
- virtual [telux::common::Status deregisterListener](#) (std::weak\_ptr< [IRemoteSimListener](#) > listener)=0
- virtual int [getSlotId](#) ()=0
- virtual [~IRemoteSimManager](#) ()

#### 4.15.1.2.1 Constructors and Destructors

4.15.1.2.1.1 virtual [telux::tel::IRemoteSimManager::~~IRemoteSimManager](#) ( ) [[virtual](#)]

Destructor of [IRemoteSimManager](#)

#### 4.15.1.2.2 Member Function Documentation

4.15.1.2.2.1 virtual bool [telux::tel::IRemoteSimManager::isSubsystemReady](#) ( ) [[pure virtual](#)]

Checks the status of remote SIM subsystem and returns the result.

#### Deprecated

Use [IRemoteSimManager::getServiceStatus\(\)](#) API.

#### Returns

True if remote SIM subsystem is ready for service otherwise false.

4.15.1.2.2.2 virtual [std::future<bool>](#) [telux::tel::IRemoteSimManager::onSubsystemReady](#) ( ) [[pure virtual](#)]

Wait for remote SIM subsystem to be ready.

#### Deprecated

Use [InitResponseCb](#) in [PhoneFactory::getRemoteSimManager](#) instead, to get notified about subsystem readiness.

#### Returns

A future that caller can wait on to be notified when remote SIM subsystem is ready.



**4.15.1.2.2.3 virtual telux::common::ServiceStatus telux::tel::IRemoteSimManager::getServiceStatus ( ) [pure virtual]**

This status indicates whether the [IRemoteSimManager](#) object is in a usable state.

#### Returns

SERVICE\_AVAILABLE - If Remote Sim Manager is ready for service. SERVICE\_UNAVAILABLE - If Remote Sim Manager is temporarily unavailable. SERVICE\_FAILED - If Remote Sim Manager encountered an irrecoverable failure.

#### Note

Eval: This is a new API and is being evaluated. It is subject to change and could break backwards compatibility.

**4.15.1.2.2.4 virtual telux::common::Status telux::tel::IRemoteSimManager::sendReset ( telux::common::ResponseCallback *callback* = nullptr ) [pure virtual]**

Send reset command to the modem to reset state variables.

#### Parameters

out	<i>callback</i>	Callback function pointer to get the response of sendReset.
-----	-----------------	---

#### Returns

Status of sendReset i.e. success or suitable status code.

**4.15.1.2.2.5 virtual telux::common::Status telux::tel::IRemoteSimManager::sendConnectionAvailable ( telux::common::ResponseCallback *callback* = nullptr ) [pure virtual]**

Send connection available event to the modem.

#### Parameters

out	<i>callback</i>	Callback function pointer to get the response.
-----	-----------------	--

#### Returns

Status of sendConnectionAvailable i.e. success or suitable status code.

**4.15.1.2.2.6 virtual telux::common::Status telux::tel::IRemoteSimManager::sendConnectionUnavailable ( telux::common::ResponseCallback *callback* = nullptr ) [pure virtual]**

Send connection unavailable event to the modem.

**Parameters**

out	<i>callback</i>	Callback function pointer to get the response.
-----	-----------------	--

**Returns**

Status of sendConnectionUnavailable i.e. success or suitable status code.

**4.15.1.2.2.7** `virtual telux::common::Status telux::tel::IRemoteSimManager::sendCardReset ( const std::vector< uint8_t > & atr, telux::common::ResponseCallback callback = nullptr ) [pure virtual]`

Send card reset event to the modem.

**Parameters**

in	<i>atr</i>	Answer to Reset bytes (max size = 32, per ISO/IEC 7816-3:2006 section 8.1).
out	<i>callback</i>	Callback function pointer to get the response of sendCardReset.

**Returns**

Status of sendCardReset i.e. success or suitable status code.

**4.15.1.2.2.8** `virtual telux::common::Status telux::tel::IRemoteSimManager::sendCardError ( const CardErrorCause cause = CardErrorCause::INVALID, telux::common::ResponseCallback callback = nullptr ) [pure virtual]`

Send card error event to the modem.

**Parameters**

in	<i>cause</i>	Card Error cause.
out	<i>callback</i>	Callback function pointer to get the response of sendCardError.

**Returns**

Status of sendCardError i.e. success or suitable status code.

**4.15.1.2.2.9** `virtual telux::common::Status telux::tel::IRemoteSimManager::sendCardInserted ( const std::vector< uint8_t > & atr, telux::common::ResponseCallback callback = nullptr ) [pure virtual]`

Send card inserted event to the modem.

**Parameters**

in	<i>atr</i>	Answer to Reset bytes (max size = 32, per ISO/IEC 7816-3:2006 section 8.1).
----	------------	---

out	<i>callback</i>	Callback function pointer to get the response of sendCardInserted.
-----	-----------------	--

**Returns**

Status of sendCardInserted i.e. success or suitable status code.

#### 4.15.1.2.2.10 virtual telux::common::Status telux::tel::IRemoteSimManager::sendCardRemoved ( telux::common::ResponseCallback *callback* = nullptr ) [pure virtual]

Send card removed event to the modem.

**Parameters**

out	<i>callback</i>	Callback function pointer to get the response of sendCardRemoved.
-----	-----------------	---

**Returns**

Status of sendCardRemoved i.e. success or suitable status code.

#### 4.15.1.2.2.11 virtual telux::common::Status telux::tel::IRemoteSimManager::sendCardWakeup ( telux::common::ResponseCallback *callback* = nullptr ) [pure virtual]

Send card wakeup event to the modem.

**Parameters**

out	<i>callback</i>	Callback function pointer to get the response of sendCardWakeup.
-----	-----------------	--

**Returns**

Status of sendCardWakeup i.e. success or suitable status code.

#### 4.15.1.2.2.12 virtual telux::common::Status telux::tel::IRemoteSimManager::sendApdu ( const unsigned int *id*, const std::vector< uint8\_t > & *apdu*, const bool *isSuccess* = true, const unsigned int *totalSize* = 0, const unsigned int *offset* = 0, telux::common::ResponseCallback *callback* = nullptr ) [pure virtual]

Sends an APDU message to the modem, in response to a previous APDU sent by the modem.

**Parameters**

in	<i>id</i>	Identifier for command and response APDU pair.
in	<i>apdu</i>	Response APDU (max size = 1024).
in	<i>isSuccess</i>	Whether APDU transaction completed successfully.

in	<i>totalSize</i>	Total length of the APDU message (used when the response is larger than 1024 bytes and must be passed in multiple segments).
in	<i>offset</i>	Offset of this APDU segment in the original message.
out	<i>callback</i>	Callback function pointer to get the response of sendApdu.

**Returns**

Status of sendApdu i.e. success or suitable status code.

**4.15.1.2.2.13** `virtual telux::common::Status telux::tel::IRemoteSimManager::registerListener ( std::weak_ptr< IRemoteSimListener > listener ) [pure virtual]`

Register a listener for specific updates from the modem.

**Parameters**

in	<i>listener</i>	Pointer of <a href="#">IRemoteSimListener</a> object that processes the notification
----	-----------------	--

**Returns**

Status of registerListener i.e success or suitable status code.

**4.15.1.2.2.14** `virtual telux::common::Status telux::tel::IRemoteSimManager::deregisterListener ( std::weak_ptr< IRemoteSimListener > listener ) [pure virtual]`

Deregister the previously added listener.

**Parameters**

in	<i>listener</i>	Previously registered <a href="#">IRemoteSimListener</a> that needs to be deregistered
----	-----------------	--

**Returns**

Status of deregisterListener success or suitable status code

**4.15.1.2.2.15** `virtual int telux::tel::IRemoteSimManager::getSlotId ( ) [pure virtual]`

Get associated slot ID for the RemoteSimManager

**Returns**

The slot ID associated with this [IRemoteSimManager](#)

## 4.15.2 Enumeration Type Documentation

### 4.15.2.1 enum telux::tel::CardErrorCause [strong]

Defines the card error cause, sent to the modem by the SIM provider

#### Enumerator

**INVALID** Card error cause value will not be passed to modem

**UNKNOWN\_ERROR** Unknown error

**NO\_LINK\_ESTABLISHED** No link was established

**COMMAND\_TIMEOUT** Command timeout

**POWER\_DOWN** Error due to a card power down

## 4.16 Supplementary Services

This section contains APIs related to supplementary services to provide services like call forwarding, call waiting.

### 4.16.1 Data Structure Documentation

#### 4.16.1.1 class telux::tel::ISuppServicesListener

A listener class for receiving supplementary services notifications. The methods in listener can be invoked from multiple different threads. The implementation should be thread safe.

##### Public member functions

- virtual [~ISuppServicesListener](#) ()  
*Destroy the [ISuppServicesListener](#) object.*

##### 4.16.1.1.1 Constructors and Destructors

###### 4.16.1.1.1 virtual telux::tel::ISuppServicesListener::~~ISuppServicesListener ( ) [virtual]

Destroy the [ISuppServicesListener](#) object.

#### 4.16.1.2 struct telux::tel::ForwardInfo

Represents parameters for forwarding.

##### Data fields

Type	Field	Description
<a href="#">SuppServices↔ Status</a>	status	Status of the supplementary service
<a href="#">ServiceClass</a>	serviceClass	Service class
string	number	Phone number to which the call to be forwarded
uint8_t	noReplyTimer	No reply timer

#### 4.16.1.3 struct telux::tel::ForwardReq

Represents parameters required for forwarding request.

##### Data fields

Type	Field	Description
<a href="#">Forward↔ Operation</a>	operation	Type of operation for forwarding
<a href="#">ForwardReason</a>	reason	Reason for call forwarding <a href="#">telux::tel::ForwardReason</a>
<a href="#">ServiceClass</a>	serviceClass	Service Class for operation <a href="#">telux::tel::ServiceClass</a>

Type	Field	Description
string	number	Number to which call has to be forwarded. This parameter is required only for registration purpose only. <a href="#">telux::tel::ForwardOperation::REGISTER</a>
uint8_t	noReplyTimer	Timer for no reply operation. Required only for no reply forward reason. <a href="#">telux::tel::ForwardReason::NOREPLY</a> .

#### 4.16.1.4 class telux::tel::ISuppServicesManager

[ISuppServicesManager](#) is the interface to provide supplementary services like call forwarding and call waiting.

##### Public member functions

- virtual [telux::common::ServiceStatus](#) getServiceStatus ()=0
- virtual [telux::common::Status](#) setCallWaitingPref ([SuppServicesStatus](#) suppSvcStatus, [SetSuppSvcPrefCallback](#) callback=nullptr)=0
- virtual [telux::common::Status](#) requestCallWaitingPref ([GetCallWaitingPrefExCb](#) callback)=0
- virtual [telux::common::Status](#) setForwardingPref ([ForwardReq](#) forwardReq, [SetSuppSvcPrefCallback](#) callback=nullptr)=0
- virtual [telux::common::Status](#) requestForwardingPref ([ServiceClass](#) serviceClass, [ForwardReason](#) reason, [GetForwardingPrefExCb](#) callback)=0
- virtual [telux::common::Status](#) setOirPref ([ServiceClass](#) serviceClass, [SuppServicesStatus](#) suppSvcStatus, [SetSuppSvcPrefCallback](#) callback=nullptr)=0
- virtual [telux::common::Status](#) requestOirPref ([ServiceClass](#) serviceClass, [GetOirPrefCb](#) callback)=0
- virtual [telux::common::Status](#) registerListener (std::weak\_ptr< [ISuppServicesListener](#) > listener)=0
- virtual [telux::common::Status](#) removeListener (std::weak\_ptr< [ISuppServicesListener](#) > listener)=0
- virtual [~ISuppServicesManager](#) ()
- virtual [telux::common::Status](#) requestCallWaitingPref ([GetCallWaitingPrefCb](#) callback)=0
- virtual [telux::common::Status](#) requestForwardingPref ([ServiceClass](#) serviceClass, [ForwardReason](#) reason, [GetForwardingPrefCb](#) callback)=0

##### 4.16.1.4.1 Constructors and Destructors

4.16.1.4.1.1 virtual [telux::tel::ISuppServicesManager::~~ISuppServicesManager](#) ( ) [virtual]

Destructor for ISupplementaryServicesManager

##### 4.16.1.4.2 Member Function Documentation

**4.16.1.4.2.1 virtual telux::common::ServiceStatus telux::tel::ISuppServicesManager::getServiceStatus ( ) [pure virtual]**

This status indicates whether the [ISuppServicesManager](#) object is in a usable state.

**Returns**

SERVICE\_AVAILABLE - If [ISuppServicesManager](#) manager is ready for service.  
 SERVICE\_UNAVAILABLE - If [ISuppServicesManager](#) manager is temporarily unavailable.  
 SERVICE\_FAILED - If [ISuppServicesManager](#) manager encountered an irrecoverable failure.

**4.16.1.4.2.2 virtual telux::common::Status telux::tel::ISuppServicesManager::setCallWaitingPref ( SuppServicesStatus *suppSvcStatus*, SetSuppSvcPrefCallback *callback = nullptr* ) [pure virtual]**

Enable/disable call waiting on device.

On platforms with Access control enabled, Caller needs to have TELUX\_TEL\_SUPP\_SERVICES permissions to invoke this API successfully.

**Parameters**

in	<i>suppSvcStatus</i>	- Call waiting preference <a href="#">telux::tel::SuppServicesStatus</a> .
in	<i>callback</i>	- Callback function to get the response of setCallWaitingPref

**Returns**

Status of setCallWaitingPref i.e. success or suitable error code.

**4.16.1.4.2.3 virtual telux::common::Status telux::tel::ISuppServicesManager::requestCallWaitingPref ( GetCallWaitingPrefExCb *callback* ) [pure virtual]**

This API queries the preference for call waiting.

On platforms with Access control enabled, Caller needs to have TELUX\_TEL\_SUPP\_SERVICES permissions to invoke this API successfully.

**Parameters**

in	<i>callback</i>	- Callback function to get the response of call waiting preference.
----	-----------------	---

**Returns**

Status of requestCallWaitingPref i.e. success or suitable error code.



**4.16.1.4.2.4** `virtual telux::common::Status telux::tel::ISuppServicesManager::setForwardingPref ( ForwardReq forwardReq, SetSuppSvcPrefCallback callback = nullptr ) [pure virtual]`

To set call forwarding preference.

On platforms with Access control enabled, Caller needs to have TELUX\_TEL\_SUPP\_SERVICES permissions to invoke this API successfully.

#### Parameters

in	<i>forwardReq</i>	- Parameters for call forwarding operation. <a href="#">telux::tel::ForwardReq</a>
in	<i>callback</i>	- Callback function to get response of setForwardingPref API.

#### Returns

Status of setForwardingPref i.e. success or suitable error code.

**4.16.1.4.2.5** `virtual telux::common::Status telux::tel::ISuppServicesManager::requestForwardingPref ( ServiceClass serviceClass, ForwardReason reason, GetForwardingPrefExCb callback ) [pure virtual]`

This API queries preference for call forwarding supplementary service. If active, returns for which service classes and call forwarding number it is active. There is an option to configure for which service class the request is made, if the option is not configured it assumes that the request is made for all service classes.

On platforms with Access control enabled, Caller needs to have TELUX\_TEL\_SUPP\_SERVICES permissions to invoke this API successfully.

#### Parameters

in	<i>serviceClass</i>	- Service class <a href="#">telux::tel::ServiceClass</a> .
in	<i>callback</i>	- Callback function to get the response of request call forwarding preference.

#### Returns

Status of requestForwardingPref i.e. success or suitable error code.

**4.16.1.4.2.6** `virtual telux::common::Status telux::tel::ISuppServicesManager::setOirPref ( ServiceClass serviceClass, SuppServicesStatus suppSvcStatus, SetSuppSvcPrefCallback callback = nullptr ) [pure virtual]`

Activate/Deactivate originating identification restriction preference on the device. If the OIR service was activated, the original call number will be restricted to the target when a call is dialed to a subscriber.

On platforms with access control enabled, the caller must have TELUX\_TEL\_SUPP\_SERVICES permissions to invoke this API successfully.

**Parameters**

in	<i>serviceClass</i>	- Service class <a href="#">telux::tel::ServiceClass</a> .
in	<i>suppSvcStatus</i>	- OIR Status <a href="#">telux::tel::SuppServicesStatus</a> .
in	<i>callback</i>	- Callback function to get the response of setOIRPref

**Returns**

Status of setOirPref i.e. success or suitable error code.

#### 4.16.1.4.2.7 virtual telux::common::Status telux::tel::ISuppServicesManager::requestOirPref ( ServiceClass *serviceClass*, GetOirPrefCb *callback* ) [pure virtual]

This API queries the originating identification restriction preference.

On platforms with access control enabled, the caller must have TELUX\_TEL\_SUPP\_SERVICES permissions to invoke this API successfully.

**Parameters**

in	<i>serviceClass</i>	- Service class <a href="#">telux::tel::ServiceClass</a> .
in	<i>callback</i>	- Callback function to get the response of requestOIRPref

**Returns**

Status of requestOirPref i.e. success or suitable error code.

#### 4.16.1.4.2.8 virtual telux::common::Status telux::tel::ISuppServicesManager::registerListener ( std::weak\_ptr< ISuppServicesListener > *listener* ) [pure virtual]

Register a listener for supplementary services events.

**Parameters**

in	<i>listener</i>	Pointer to <a href="#">ISuppServicesListener</a> object that processes the notification.
----	-----------------	--

**Returns**

Status of registerListener i.e. success or suitable status code.

#### 4.16.1.4.2.9 virtual telux::common::Status telux::tel::ISuppServicesManager::removeListener ( std::weak\_ptr< ISuppServicesListener > *listener* ) [pure virtual]

Remove a previously added listener.

**Parameters**

in	<i>listener</i>	Pointer to <a href="#">ISuppServicesListener</a> object that needs to be removed.
----	-----------------	---

**Returns**

Status of removeListener i.e. success or suitable status code.

#### 4.16.1.4.2.10 **virtual telux::common::Status telux::tel::ISuppServicesManager::requestCallWaitingPref ( GetCallWaitingPrefCb *callback* ) [pure virtual]**

This API queries the preference for call waiting.

**Parameters**

in	<i>callback</i>	- Callback function to get the response of requestCallWaitingPref.
----	-----------------	--

**Returns**

Status of requestCallWaitingPref i.e. success or suitable error code.

**Deprecated**

This API is not being supported instead use requestCallWaitingPref( GetCallWaitingPrefExCb) API.

#### 4.16.1.4.2.11 **virtual telux::common::Status telux::tel::ISuppServicesManager::requestForwardingPref ( ServiceClass *serviceClass*, ForwardReason *reason*, GetForwardingPrefCb *callback* ) [pure virtual]**

This API queries preference for call forwarding supplementary service. If active, returns for which service classes and call forwarding number it is active. It also returns the provision status of the supplementary service. There is an option to configure for which service class the request is made, if the option is not configured it assumes that the request is made for all service classes.

**Parameters**

in	<i>serviceClass</i>	- Service class <a href="#">telux::tel::ServiceClass</a> .
in	<i>callback</i>	- Callback function to get the response of request call forwarding preference.

**Returns**

Status of requestForwardingPref i.e. success or suitable error code.

**Deprecated**

This API is not being supported instead use requestForwardingPref( ServiceClass *serviceClass*, ForwardReason *reason*, GetForwardingPrefExCb *callback*) API.

## 4.16.2 Enumeration Type Documentation

### 4.16.2.1 enum telux::tel::SuppServicesStatus [strong]

Defines supplementary services status.

#### Enumerator

**UNKNOWN** Supplementary service status unknown

**ENABLED** Supplementary service is enabled

**DISABLED** Supplementary service is disabled

### 4.16.2.2 enum telux::tel::SuppSvcProvisionStatus [strong]

Defines supplementary services provision status.

#### Enumerator

**UNKNOWN** Supplementary service provision status unknown

**NOT\_PROVISIONED** Supplementary service is not provisioned

**PROVISIONED** Supplementary service is provisioned

**PRESENTATION\_RESTRICTED** Supplementary service is presentation restricted

**PRESENTATION\_ALLOWED** Supplementary service is presentation allowed

### 4.16.2.3 enum telux::tel::ForwardOperation [strong]

Defines call forwarding operation.

#### Enumerator

**UNKNOWN** Status unknown

**ACTIVATE** To activate call forwarding

**DEACTIVATE** To deactivate call forwarding

**REGISTER** To register for call forwarding

**ERASE** To erase the previous registration

### 4.16.2.4 enum telux::tel::ForwardReason [strong]

Defines reasons for call forwarding.

#### Enumerator

**UNCONDITIONAL** Unconditional call forwarding

**BUSY** Forward when the device is busy on another call

**NOREPLY** Forward when there is no reply

**NOT\_REACHABLE** Forward when the device is unreachable

**NOT\_LOGGED\_IN** Forward when the device is not logged in

#### 4.16.2.5 enum telux::tel::ServiceClassType [strong]

Defines service class for telephony

##### Enumerator

**NONE** Service class not provided  
**VOICE** Service class voice

#### 4.16.2.6 enum telux::tel::FailureCause [strong]

Represents the cause for supplementary services failure.

##### Enumerator

**UNAVAILABLE**  
**OFFLINE**  
**CDMA\_LOCK**  
**NO\_SRV**  
**FADE**  
**INTERCEPT**  
**REORDER**  
**REL\_NORMAL**  
**REL\_SO\_REJ**  
**INCOM\_CALL**  
**ALERT\_STOP**  
**CLIENT\_END**  
**ACTIVATION**  
**MC\_ABORT**  
**MAX\_ACCESS\_PROBE**  
**PSIST\_N**  
**UIM\_NOT\_PRESENT**  
**ACC\_IN\_PROG**  
**ACC\_FAIL**  
**RETRY\_ORDER**  
**CCS\_NOT\_SUPPORTED\_BY\_BS**  
**NO\_RESPONSE\_FROM\_BS**  
**REJECTED\_BY\_BS**  
**INCOMPATIBLE**  
**ACCESS\_BLOCK**  
**ALREADY\_IN\_TC**  
**EMERGENCY\_FLASHED**  
**USER\_CALL\_ORIG\_DURING\_GPS**  
**USER\_CALL\_ORIG\_DURING\_SMS**  
**USER\_CALL\_ORIG\_DURING\_DATA**  
**REDIR\_OR\_HANDOFF**  
**ACCESS\_BLOCK\_ALL**  
**OTASP\_SPC\_ERR**  
**IS707B\_MAX\_ACC**  
**ACC\_FAIL\_REJ\_ORD**  
**ACC\_FAIL\_RETRY\_ORD**

**TIMEOUT\_T42**  
**TIMEOUT\_T40**  
**SRV\_INIT\_FAIL**  
**T50\_EXP**  
**T51\_EXP**  
**RL\_ACK\_TIMEOUT**  
**BAD\_FL**  
**TRM\_REQ\_FAIL**  
**TIMEOUT\_T41**  
**INCOM\_REJ**  
**SETUP\_REJ**  
**NETWORK\_END**  
**NO\_FUNDS**  
**NO\_GW\_SRV**  
**NO\_CDMA\_SRV**  
**NO\_FULL\_SRV**  
**MAX\_PS\_CALLS**  
**UNKNOWN\_SUBSCRIBER**  
**ILLEGAL\_SUBSCRIBER**  
**BEARER\_SERVICE\_NOT\_PROVISIONED**  
**TELE\_SERVICE\_NOT\_PROVISIONED**  
**ILLEGAL\_EQUIPMENT**  
**CALL\_BARRED**  
**ILLEGAL\_SS\_OPERATION**  
**SS\_ERROR\_STATUS**  
**SS\_NOT\_AVAILABLE**  
**SS\_SUBSCRIPTION\_VIOLATION**  
**SS\_INCOMPATIBILITY**  
**FACILITY\_NOT\_SUPPORTED**  
**ABSENT\_SUBSCRIBER**  
**SHORT\_TERM\_DENIAL**  
**LONG\_TERM\_DENIAL**  
**SYSTEM\_FAILURE**  
**DATA\_MISSING**  
**UNEXPECTED\_DATA\_VALUE**  
**PWD\_REGISTRATION\_FAILURE**  
**NEGATIVE\_PWD\_CHECK**  
**NUM\_OF\_PWD\_ATTEMPTS\_VIOLATION**  
**POSITION\_METHOD\_FAILURE**  
**UNKNOWN\_ALPHABET**  
**USSD\_BUSY**  
**REJECTED\_BY\_USER**  
**REJECTED\_BY\_NETWORK**  
**DEFLECTION\_TO\_SERVED\_SUBSCRIBER**  
**SPECIAL\_SERVICE\_CODE**  
**INVALID\_DEFLECTED\_TO\_NUMBER**  
**MPTY\_PARTICIPANTS\_EXCEEDED**  
**RESOURCES\_NOT\_AVAILABLE**  
**UNASSIGNED\_NUMBER**  
**NO\_ROUTE\_TO\_DESTINATION**

**CHANNEL\_UNACCEPTABLE**  
**OPERATOR\_DETERMINED\_BARRING**  
**NORMAL\_CALL\_CLEARING**  
**USER\_BUSY**  
**NO\_USER\_RESPONDING**  
**USER\_ALERTING\_NO\_ANSWER**  
**CALL\_REJECTED**  
**NUMBER\_CHANGED**  
**PREEMPTION**  
**DESTINATION\_OUT\_OF\_ORDER**  
**INVALID\_NUMBER\_FORMAT**  
**FACILITY\_REJECTED**  
**RESP\_TO\_STATUS\_ENQUIRY**  
**NORMAL\_UNSPECIFIED**  
**NO\_CIRCUIT\_OR\_CHANNEL\_AVAILABLE**  
**NETWORK\_OUT\_OF\_ORDER**  
**TEMPORARY\_FAILURE**  
**SWITCHING\_EQUIPMENT\_CONGESTION**  
**ACCESS\_INFORMATION\_DISCARDED**  
**REQUESTED\_CIRCUIT\_OR\_CHANNEL\_NOT\_AVAILABLE**  
**RESOURCES\_UNAVAILABLE\_OR\_UNSPECIFIED**  
**QOS\_UNAVAILABLE**  
**REQUESTED\_FACILITY\_NOT\_SUBSCRIBED**  
**INCOMING\_CALLS\_BARRED\_WITHIN\_CUG**  
**BEARER\_CAPABILITY\_NOT\_AUTH**  
**BEARER\_CAPABILITY\_UNAVAILABLE**  
**SERVICE\_OPTION\_NOT\_AVAILABLE**  
**ACM\_LIMIT\_EXCEEDED**  
**BEARER\_SERVICE\_NOT\_IMPLEMENTED**  
**REQUESTED\_FACILITY\_NOT\_IMPLEMENTED**  
**ONLY\_DIGITAL\_INFORMATION\_BEARER\_AVAILABLE**  
**SERVICE\_OR\_OPTION\_NOT\_IMPLEMENTED**  
**INVALID\_TRANSACTION\_IDENTIFIER**  
**USER\_NOT\_MEMBER\_OF\_CUG**  
**INCOMPATIBLE\_DESTINATION**  
**INVALID\_TRANSIT\_NW\_SELECTION**  
**SEMANTICALLY\_INCORRECT\_MESSAGE**  
**INVALID\_MANDATORY\_INFORMATION**  
**MESSAGE\_TYPE\_NON\_IMPLEMENTED**  
**MESSAGE\_TYPE\_NOT\_COMPATIBLE\_WITH\_PROTOCOL\_STATE**  
**INFORMATION\_ELEMENT\_NON\_EXISTENT**  
**CONDITONAL\_IE\_ERROR**  
**MESSAGE\_NOT\_COMPATIBLE\_WITH\_PROTOCOL\_STATE**  
**RECOVERY\_ON\_TIMER\_EXPIRED**  
**PROTOCOL\_ERROR\_UNSPECIFIED**  
**INTERWORKING\_UNSPECIFIED**  
**OUTGOING\_CALLS\_BARRED\_WITHIN\_CUG**  
**NO\_CUG\_SELECTION**  
**UNKNOWN\_CUG\_INDEX**  
**CUG\_INDEX\_INCOMPATIBLE**

**CUG\_CALL\_FAILURE\_UNSPECIFIED**  
**CLIR\_NOT\_SUBSCRIBED**  
**CCBS\_POSSIBLE**  
**CCBS\_NOT\_POSSIBLE**  
**IMSI\_UNKNOWN\_IN\_HLR**  
**ILLEGAL\_MS**  
**IMSI\_UNKNOWN\_IN\_VLR**  
**IMEI\_NOT\_ACCEPTED**  
**ILLEGAL\_ME**  
**PLMN\_NOT\_ALLOWED**  
**LOCATION\_AREA\_NOT\_ALLOWED**  
**ROAMING\_NOT\_ALLOWED\_IN\_THIS\_LOCATION\_AREA**  
**NO\_SUITABLE\_CELLS\_IN\_LOCATION\_AREA**  
**NETWORK\_FAILURE**  
**MAC\_FAILURE**  
**SYNCH\_FAILURE**  
**NETWORK\_CONGESTION**  
**GSM\_AUTHENTICATION\_UNACCEPTABLE**  
**SERVICE\_NOT\_SUBSCRIBED**  
**SERVICE\_TEMPORARILY\_OUT\_OF\_ORDER**  
**CALL\_CANNOT\_BE\_IDENTIFIED**  
**INCORRECT\_SEMANTICS\_IN\_MESSAGE**  
**MANDATORY\_INFORMATION\_INVALID**  
**ACCESS\_STRATUM\_FAILURE**  
**INVALID\_SIM**  
**WRONG\_STATE**  
**ACCESS\_CLASS\_BLOCKED**  
**NO\_RESOURCES**  
**INVALID\_USER\_DATA**  
**TIMER\_T3230\_EXPIRED**  
**NO\_CELL\_AVAILABLE**  
**ABORT\_MSG\_RECEIVED**  
**RADIO\_LINK\_LOST**  
**TIMER\_T303\_EXPIRED**  
**CNM\_MM\_REL\_PENDING**  
**ACCESS\_STRATUM\_REJ\_RR\_REL\_IND**  
**ACCESS\_STRATUM\_REJ\_RR\_RANDOM\_ACCESS\_FAILURE**  
**ACCESS\_STRATUM\_REJ\_RRC\_REL\_IND**  
**ACCESS\_STRATUM\_REJ\_RRC\_CLOSE\_SESSION\_IND**  
**ACCESS\_STRATUM\_REJ\_RRC\_OPEN\_SESSION\_FAILURE**  
**ACCESS\_STRATUM\_REJ\_LOW\_LEVEL\_FAIL**  
**ACCESS\_STRATUM\_REJ\_LOW\_LEVEL\_FAIL\_REDIAL\_NOT\_ALLOWED**  
**ACCESS\_STRATUM\_REJ\_LOW\_LEVEL\_IMMED\_RETRY**  
**ACCESS\_STRATUM\_REJ\_ABORT\_RADIO\_UNAVAILABLE**  
**SERVICE\_OPTION\_NOT\_SUPPORTED**  
**ACCESS\_STRATUM\_REJ\_CONN\_EST\_FAILURE\_ACCESS\_BARRED**  
**ACCESS\_STRATUM\_REJ\_CONN\_REL\_NORMAL**  
**ACCESS\_STRATUM\_REJ\_UL\_DATA\_CNF\_FAILURE\_CONN\_REL**  
**BAD\_REQ\_WAIT\_INVITE**  
**BAD\_REQ\_WAIT\_REINVITE**



**INVALID\_REMOTE\_URI**  
**REMOTE\_UNSUPP\_MEDIA\_TYPE**  
**PEER\_NOT\_REACHABLE**  
**NETWORK\_NO\_RESP\_TIME\_OUT**  
**NETWORK\_NO\_RESP\_HOLD\_FAIL**  
**DATA\_CONNECTION\_LOST**  
**UPGRADE\_DOWNGRADE\_REJ**  
**SIP\_403\_FORBIDDEN**  
**NO\_NETWORK\_RESP**  
**UPGRADE\_DOWNGRADE\_FAILED**  
**UPGRADE\_DOWNGRADE\_CANCELLED**  
**SSAC\_REJECT**  
**THERMAL\_EMERGENCY**  
**FAILURE\_1XCSFB\_SOFT**  
**FAILURE\_1XCSFB\_HARD**  
**CONNECTION\_EST\_FAILURE**  
**CONNECTION\_FAILURE**  
**RRC\_CONN\_REL\_NO\_MT\_SETUP**  
**ESR\_FAILURE**  
**MT\_CSFB\_NO\_RESPONSE\_FROM\_NW**  
**BUSY\_EVERYWHERE**  
**ANSWERED\_ELSEWHERE**  
**RLF\_DURING\_CC\_DISCONNECT**  
**TEMP\_REDIAL\_ALLOWED**  
**PERM\_REDIAL\_NOT\_NEEDED**  
**MERGED\_TO\_CONFERENCE**  
**LOW\_BATTERY**  
**CALL\_DEFLECTED**  
**RTP\_RTCP\_TIMEOUT**  
**RINGING\_RINGBACK\_TIMEOUT**  
**REG\_RESTORATION**  
**CODEC\_ERROR**  
**UNSUPPORTED\_SDP**  
**RTP\_FAILURE**  
**QoS\_FAILURE**  
**MULTIPLE\_CHOICES**  
**MOVED\_PERMANENTLY**  
**MOVED\_TEMPORARILY**  
**USE\_PROXY**  
**ALTERNATE\_SERVICE**  
**ALTERNATE\_EMERGENCY\_CALL**  
**UNAUTHORIZED**  
**PAYMENT\_REQUIRED**  
**METHOD\_NOT\_ALLOWED**  
**NOT\_ACCEPTABLE**  
**PROXY\_AUTHENTICATION\_REQUIRED**  
**GONE**  
**REQUEST\_ENTITY\_TOO\_LARGE**  
**REQUEST\_URI\_TOO\_LARGE**  
**UNSUPPORTED\_URI\_SCHEME**

**BAD\_EXTENSION**  
**EXTENSION\_REQUIRED**  
**INTERVAL\_TOO\_BRIEF**  
**CALL\_OR\_TRANS\_DOES\_NOT\_EXIST**  
**LOOP\_DETECTED**  
**TOO\_MANY\_HOPS**  
**ADDRESS\_INCOMPLETE**  
**AMBIGUOUS**  
**REQUEST\_TERMINATED**  
**NOT\_ACCEPTABLE\_HERE**  
**REQUEST\_PENDING**  
**UNDECIPHERABLE**  
**SERVER\_INTERNAL\_ERROR**  
**NOT\_IMPLEMENTED**  
**BAD\_GATEWAY**  
**SERVER\_TIME\_OUT**  
**VERSION\_NOT\_SUPPORTED**  
**MESSAGE\_TOO\_LARGE**  
**DOES\_NOT\_EXIST\_ANYWHERE**  
**SESS\_DESCR\_NOT\_ACCEPTABLE**  
**SRVCC\_END\_CALL**  
**INTERNAL\_ERROR**  
**SERVER\_UNAVAILABLE**  
**PRECONDITION\_FAILURE**  
**DRVCC\_IN\_PROG**  
**DRVCC\_END\_CALL**  
**CS\_HARD\_FAILURE**  
**CS\_ACQ\_FAILURE**  
**REJECTED\_ELSEWHERE**  
**CALL\_PULLED**  
**CALL\_PULL\_OUT\_OF\_SYNC**  
**HOLD\_RESUME\_FAILED**  
**HOLD\_RESUME\_CANCELED**  
**REINVITE\_COLLISION**  
**REDIAL\_SECONDARY\_LINE\_CS**  
**REDIAL\_SECONDARY\_LINE\_PS**  
**REDIAL\_SECONDARY\_LINE\_CS\_AUTO**  
**REDIAL\_SECONDARY\_LINE\_PS\_AUTO**

## 4.17 Location

- [Location Services](#)

This section contains APIs related to Location.

## 4.18 Location Services

This section contains APIs related to Location Services.

### 4.18.1 Data Structure Documentation

#### 4.18.1.1 class telux::loc::IDgnssStatusListener

Listener class for getting RTCM injection event notification information.

##### Public member functions

- virtual void [onDgnssStatusUpdate](#) ([DgnssStatus](#) status)
- virtual [~IDgnssStatusListener](#) ()

##### 4.18.1.1.1 Constructors and Destructors

###### 4.18.1.1.1.1 virtual telux::loc::IDgnssStatusListener::~~IDgnssStatusListener ( ) [virtual]

Destructor of IRTCMStatusListener

##### 4.18.1.1.2 Member Function Documentation

###### 4.18.1.1.2.1 virtual void telux::loc::IDgnssStatusListener::onDgnssStatusUpdate ( [DgnssStatus](#) status ) [virtual]

This function is called asynchronously to report RTCM injection status

##### Parameters

in	<i>status</i>	- the status enum.
----	---------------	--------------------

#### 4.18.1.2 class telux::loc::IDgnssManager

IRtcManager provides interface to inject RTCM data into modem, register event listener reported by cdfw(correction data framework).

##### Public member functions

- virtual bool [isSubsystemReady](#) ()=0
- virtual [telux::common::ServiceStatus](#) [getServiceStatus](#) ()=0
- virtual std::future< bool > [onSubsystemReady](#) ()=0
- virtual [telux::common::Status](#) [registerListener](#) (std::weak\_ptr< [IDgnssStatusListener](#) > listener)=0
- virtual [telux::common::Status](#) [deRegisterListener](#) (void)=0
- virtual [telux::common::Status](#) [createSource](#) ([DgnssDataFormat](#) dataFormat)=0

- virtual [telux::common::Status releaseSource](#) (void)=0
- virtual [telux::common::Status injectCorrectionData](#) (const uint8\_t \*buffer, uint32\_t bufferSize)=0
- virtual [~IDgnssManager](#) ()

#### 4.18.1.2.1 Constructors and Destructors

4.18.1.2.1.1 virtual [telux::loc::IDgnssManager::~~IDgnssManager](#) ( ) [**virtual**]

Destructor of IRtcmManager

#### 4.18.1.2.2 Member Function Documentation

4.18.1.2.2.1 virtual **bool** [telux::loc::IDgnssManager::isSubsystemReady](#) ( ) [**pure virtual**]

Checks the status of location subsystems and returns the result.

##### Returns

True if location subsystem is ready for service otherwise false.

##### Deprecated

use [getServiceStatus\(\)](#)

4.18.1.2.2.2 virtual **telux::common::ServiceStatus** [telux::loc::IDgnssManager::getServiceStatus](#) ( ) [**pure virtual**]

This status indicates whether the object is in a usable state.

##### Returns

**SERVICE\_AVAILABLE** - If Dgnss manager is ready for service. **SERVICE\_UNAVAILABLE** - If Dgnss manager is temporarily unavailable. **SERVICE\_FAILED** - If Dgnss manager encountered an irrecoverable failure.

4.18.1.2.2.3 virtual **std::future<bool>** [telux::loc::IDgnssManager::onSubsystemReady](#) ( ) [**pure virtual**]

Wait for location subsystem to be ready.

##### Returns

A future that caller can wait on to be notified when location subsystem is ready.

##### Deprecated

The callback mechanism introduced in the [LocationFactory::getDgnssManager\(\)](#) API will provide the

similar notification mechanism as [onSubsystemReady\(\)](#). This API will soon be removed from further releases.

**4.18.1.2.2.4** `virtual telux::common::Status telux::loc::IDgnssManager::registerListener ( std::weak_ptr< IDgnssStatusListener > listener ) [pure virtual]`

Register a listener for Dgnss injection status update.

#### Parameters

in	<i>listener</i>	- Pointer of <a href="#">IDgnssStatusListener</a> object that processes the notification.
----	-----------------	---

#### Returns

Status of registerListener i.e success or suitable status code.

**4.18.1.2.2.5** `virtual telux::common::Status telux::loc::IDgnssManager::deRegisterListener ( void ) [pure virtual]`

deRegister a listener for Dgnss injection status update.

#### Returns

Status of registerListener i.e success or suitable status code.

**4.18.1.2.2.6** `virtual telux::common::Status telux::loc::IDgnssManager::createSource ( DgnssDataFormat dataFormat ) [pure virtual]`

Create a Dgnss injection source. Only one source is permitted at any given time. If a new source is to be used, user must call [releaseSource\(\)](#) to release previous source before calling this function.

#### Parameters

in	<i>dataFormat</i>	Dgnss injection data format.
----	-------------------	------------------------------

#### Returns

Success of suitable status code

#### 4.18.1.2.2.7 virtual telux::common::Status telux::loc::IDgnssManager::releaseSource ( void ) [pure virtual]

Release current Dgnss injection source (previously created by [createSource\(\)](#) call) This function is to be called if it's determined that current injection data is not suitable anymore, and a new source will be created and used as injection source.

##### Returns

none

#### 4.18.1.2.2.8 virtual telux::common::Status telux::loc::IDgnssManager::injectCorrectionData ( const uint8\_t\* *buffer*, uint32\_t *bufferSize* ) [pure virtual]

Inject correction data This function is to be called when a source has been created, either through a explicit call to [createSource\(\)](#), or after DgnssManager object was instantiated through the factory method(The factory method create a default source for DgnssManager object).

##### Parameters

in	<i>buffer</i>	buffer contains the data to be injected.
in	<i>bufferSize</i>	size of the buffer.

##### Returns

success or suitable status code.

### 4.18.1.3 class telux::loc::ILocationConfigurator

[ILocationConfigurator](#) allows general engine configurations (example: TUNC, PACE etc), configuration of specific engines like SPE (example: minSVElevation, minGPSWeek etc) or DRE, deletion of warm and cold aiding data, NMEA configuration and support for XTRA feature. [ILocationConfigurator](#) APIs strictly adheres to the principle of single client per process.

##### Public Types

- using [GetSecondaryBandCallback](#) = std::function< void(const [telux::loc::ConstellationSet](#) set, [telux::common::ErrorCode](#) error)>
- using [GetMinGpsWeekCallback](#) = std::function< void(uint16\_t minGpsWeek, [telux::common::ErrorCode](#) error)>
- using [GetMinSVElevationCallback](#) = std::function< void(uint8\_t minSVElevation, [telux::common::ErrorCode](#) error)>
- using [GetRobustLocationCallback](#) = std::function< void(const [telux::loc::RobustLocationConfiguration](#) rLConfig, [telux::common::ErrorCode](#) error)>
- using [GetXtraStatusCallback](#) = std::function< void(const [telux::loc::XtraStatus](#) xtraStatus, [telux::common::ErrorCode](#) error)>

**Public member functions**

- virtual bool `isSubsystemReady` ()=0
- virtual `telux::common::ServiceStatus getServiceStatus` ()=0
- virtual `std::future< bool > onSubsystemReady` ()=0
- virtual `telux::common::Status configureCTunc` (bool enable, `telux::common::ResponseCallback` callback=nullptr, float timeUncertainty=DEFAULT\_TUNC\_THRESHOLD, uint32\_t energyBudget=DEFAULT\_TUNC\_ENERGY\_THRESHOLD)=0
- virtual `telux::common::Status configurePACE` (bool enable, `telux::common::ResponseCallback` callback=nullptr)=0
- virtual `telux::common::Status deleteAllAidingData` (`telux::common::ResponseCallback` callback=nullptr)=0
- virtual `telux::common::Status configureLeverArm` (const `LeverArmConfigInfo` &info, `telux::common::ResponseCallback` callback=nullptr)=0
- virtual `telux::common::Status configureConstellations` (const `SvBlackList` &list, `telux::common::ResponseCallback` callback=nullptr, bool resetToDefault=false)=0
- virtual `telux::common::Status configureSecondaryBand` (const `ConstellationSet` &set, `telux::common::ResponseCallback` callback=nullptr)=0
- virtual `telux::common::Status requestSecondaryBandConfig` (`GetSecondaryBandCallback` cb)=0
- virtual `telux::common::Status configureRobustLocation` (bool enable, bool enableForE911=false, `telux::common::ResponseCallback` callback=nullptr)=0
- virtual `telux::common::Status requestRobustLocation` (`GetRobustLocationCallback` cb)=0
- virtual `telux::common::Status configureMinGpsWeek` (uint16\_t minGpsWeek, `telux::common::ResponseCallback` callback=nullptr)=0
- virtual `telux::common::Status requestMinGpsWeek` (`GetMinGpsWeekCallback` cb)=0
- virtual `telux::common::Status configureMinSVElevation` (uint8\_t minSVElevation, `telux::common::ResponseCallback` callback=nullptr)=0
- virtual `telux::common::Status requestMinSVElevation` (`GetMinSVElevationCallback` cb)=0
- virtual `telux::common::Status deleteAidingData` (`AidingData` aidingDataMask, `telux::common::ResponseCallback` callback=nullptr)=0
- virtual `telux::common::Status configureDR` (const `DREngineConfiguration` &config, `telux::common::ResponseCallback` callback=nullptr)=0
- virtual `telux::common::Status configureEngineState` (const `EngineType` engineType, const `LocationEngineRunState` engineState, `telux::common::ResponseCallback` callback=nullptr)=0
- virtual `telux::common::Status provideConsentForTerrestrialPositioning` (bool userConsent, `telux::common::ResponseCallback` callback=nullptr)=0
- virtual `telux::common::Status configureNmeaTypes` (const `NmeaSentenceConfig` nmeaType, `telux::common::ResponseCallback` callback=nullptr)=0
- virtual `telux::common::Status configureNmea` (const `NmeaConfig` configParams,



`telux::common::ResponseCallback callback=nullptr)=0`

- virtual `telux::common::Status configureEngineIntegrityRisk` (const `EngineType` engineType, `uint32_t` integrityRisk, `telux::common::ResponseCallback` callback=nullptr)=0
- virtual `telux::common::Status configureXtraParams` (bool enable, const `XtraConfig` configParams, `telux::common::ResponseCallback` callback=nullptr)=0
- virtual `telux::common::Status requestXtraStatus` (`GetXtraStatusCallback` callback)=0
- virtual `telux::common::Status registerListener` (`LocConfigIndications` indicationList, `std::weak_ptr< ILocationConfigListener >` listener)=0
- virtual `telux::common::Status deRegisterListener` (`LocConfigIndications` indicationList, `std::weak_ptr< ILocationConfigListener >` listener)=0
- virtual `telux::common::Status injectMerkleTreeInformation` (`std::string` merkleTreeInfo, `telux::common::ResponseCallback` callback=nullptr)=0
- virtual `telux::common::Status configureOsma` (bool enable, `telux::common::ResponseCallback` callback=nullptr)=0
- virtual `~ILocationConfigurator` ()

#### 4.18.1.3.1 Member Typedef Documentation

**4.18.1.3.1.1** using `telux::loc::ILocationConfigurator::GetSecondaryBandCallback = std::function<void(const telux::loc::ConstellationSet set, telux::common::ErrorCode error)>`

This function is called with the response to `requestSecondaryBandConfig` API.

##### Parameters

in	<i>set</i>	- disabled secondary band constellation configuration used by the GNSS standard position engine (SPE).
in	<i>error</i>	- Return code which indicates whether the operation succeeded or not.

**4.18.1.3.1.2** using `telux::loc::ILocationConfigurator::GetMinGpsWeekCallback = std::function<void(uint16_t minGpsWeek, telux::common::ErrorCode error)>`

This function is called with the response to `requestMinGpsWeek` API.

##### Parameters

in	<i>minGpsWeek</i>	- minimum gps week.
in	<i>error</i>	- Return code which indicates whether the operation succeeded or not.

**4.18.1.3.1.3** using `telux::loc::ILocationConfigurator::GetMinSVElevationCallback = std::function<void(uint8_t minSVElevation, telux::common::ErrorCode error)>`

This function is called with the response to requestMinSVElevation API.

#### Parameters

in	<i>minSVElevation</i>	- minimum SV Elevation angle in units of degree.
in	<i>error</i>	- Return code which indicates whether the operation succeeded or not.

**4.18.1.3.1.4** using `telux::loc::ILocationConfigurator::GetRobustLocationCallback = std::function<void(const telux::loc::RobustLocationConfiguration rLConfig, telux::common::ErrorCode error)>`

This function is called with the response to requestRobustLocation API.

#### Parameters

in	<i>rLConfig</i>	- robust location settings information.
in	<i>error</i>	- Return code which indicates whether the operation succeeded or not.

**4.18.1.3.1.5** using `telux::loc::ILocationConfigurator::GetXtraStatusCallback = std::function<void(const telux::loc::XtraStatus xtraStatus, telux::common::ErrorCode error)>`

This function is called with the response to requestXtraStatus API.

#### Parameters

in	<i>xtraStatus</i>	- Information pertaining to Xtra assistance data.
in	<i>error</i>	- Return code which indicates whether the operation succeeded or not.

### 4.18.1.3.2 Constructors and Destructors

**4.18.1.3.2.1** virtual `telux::loc::ILocationConfigurator::~~ILocationConfigurator ( ) [virtual]`

Destructor of [ILocationConfigurator](#)

### 4.18.1.3.3 Member Function Documentation

**4.18.1.3.3.1 virtual bool telux::loc::ILocationConfigurator::isSubsystemReady ( ) [pure virtual]**

Checks the status of location configuration subsystems and returns the result.

**Returns**

True if location configuration subsystem is ready for service otherwise false.

**Deprecated**

use [getServiceStatus\(\)](#)

**4.18.1.3.3.2 virtual telux::common::ServiceStatus telux::loc::ILocationConfigurator::getServiceStatus ( ) [pure virtual]**

This status indicates whether the object is in a usable state.

**Returns**

SERVICE\_AVAILABLE - If location configurator is ready for service. SERVICE\_UNAVAILABLE - If location configurator is temporarily unavailable. SERVICE\_FAILED - If location configurator encountered an irrecoverable failure.

**4.18.1.3.3.3 virtual std::future<bool> telux::loc::ILocationConfigurator::onSubsystemReady ( ) [pure virtual]**

Wait for location configuration subsystem to be ready.

**Returns**

A future that caller can wait on to be notified when location configuration subsystem is ready.

**Deprecated**

The callback mechanism introduced in the [LocationFactory::getLocationConfigurator\(\)](#) API will provide the similar notification mechanism as [onSubsystemReady\(\)](#). This API will soon be removed from further releases.

**4.18.1.3.3.4 virtual telux::common::Status telux::loc::ILocationConfigurator::configureCTunc ( bool enable, telux::common::ResponseCallback callback = nullptr, float timeUncertainty = DEFAULT\_TUNC\_THRESHOLD, uint32\_t energyBudget = DEFAULT\_TUNC\_ENERGY\_THRESHOLD ) [pure virtual]**

This API enables or disables the constrained time uncertainty(C-TUNC) feature. When the vehicle is turned off this API helps to put constraint on the time uncertainty. For multiple invocations of this API, client should wait for the command to finish, e.g.: via ResponseCallback received before issuing a second configureCTunc command. Behavior is not defined if client issues a second request of configureCTunc without waiting for the finish of the previous configureCTunc request.

On platforms with Access control enabled, caller needs to have TELUX\_LOC\_CONFIG permission to invoke this API successfully.

### Parameters

in	<i>enable</i>	- true for enable C-TUNC feature and false for disable C-TUNC feature.
in	<i>callback</i>	- Optional callback to get the response of enablement/disablement of C-TUNC.
in	<i>timeUncertainty</i>	- specifies the time uncertainty threshold that gps engine needs to maintain, in unit of milli-seconds. This parameter is ignored when the request is to disable this feature.
in	<i>energyBudget</i>	- specifies the power budget that the GPS engine is allowed to spend to maintain the time uncertainty, in the unit of 100 micro watt second. If the power exceeds the energyBudget then this API is disabled. This is a cumulative energy budget. This parameter is ignored when the request is to disable this feature.

### Returns

Status of configureCTunc i.e. success or suitable status code.

#### 4.18.1.3.3.5 virtual telux::common::Status telux::loc::!LocationConfigurator::configurePACE ( bool *enable*, telux::common::ResponseCallback *callback* = nullptr ) [pure virtual]

This API enables or disables position assisted clock estimator feature. For multiple invocations of this API, client should wait for the command to finish, e.g.: via ResponseCallback received before issuing a second configurePACE command. Behavior is not defined if client issues a second request of configurePACE without waiting for the finish of the previous configurePACE request.

On platforms with Access control enabled, caller needs to have TELUX\_LOC\_CONFIG permission to invoke this API successfully.

### Parameters

in	<i>enable</i>	- to enable/disable position assisted clock estimator feature.
in	<i>callback</i>	- Optional callback to get the response of enablement/disablement of PACE.

#### 4.18.1.3.3.6 virtual telux::common::Status telux::loc::!LocationConfigurator::deleteAllAidingData ( telux::common::ResponseCallback *callback* = nullptr ) [pure virtual]

This API deletes all forms of aiding data from all position engines. This API deletes all assistance data used by GPS engine and force engine to do a cold start for next session. Invoking this API will trigger cold start of all position engines on the device and will cause significant delay for the position engines to produce next fix and may have other performance impact. So, this API should only be exercised with caution and only for very limited usage scenario, e.g.: for performance test and certification process.

On platforms with Access control enabled, caller needs to have TELUX\_LOC\_CONFIG permission to invoke this API successfully.

**Parameters**

in	<i>callback</i>	- Optional callback to get the response of delete aiding data.
----	-----------------	--

**4.18.1.3.3.7** `virtual telux::common::Status telux::loc::ILocationConfigurator::configureLeverArm ( const LeverArmConfigInfo & info, telux::common::ResponseCallback callback = nullptr ) [pure virtual]`

This API sets the lever arm parameters for the vehicle. LeverArm is system level parameters and it is not expected to change. So, it is needed to issue configureLeverArm once for every application processor boot-up. For multiple invocations of this API client should wait for the command to finish, e.g.: via ResponseCallback received before issuing a second configureLeverArm command. Behavior is not defined if client issues a second request of configureLeverArm without waiting for the finish of the previous configureLeverArm request.

On platforms with Access control enabled, caller needs to have TELUX\_LOC\_CONFIG permission to invoke this API successfully.

**Parameters**

in	<i>info</i>	- lever arm configuration info regarding below three types of lever arm info: a: GNSS Antenna with respect to the origin at the IMU (inertial measurement unit) for DR engine b: GNSS Antenna with respect to the origin at the IMU (inertial measurement unit) for VEPP engine c: VRP (Vehicle Reference Point) with respect to the origin (at the GNSS Antenna). Vehicle manufacturers prefer the position output to be tied to a specific point in the vehicle rather than where the antenna is placed (midpoint of the rear axle is typical).
in	<i>callback</i>	- Optional callback to get the response of configure lever arm.

**4.18.1.3.3.8** `virtual telux::common::Status telux::loc::ILocationConfigurator::configureConstellations ( const SvBlackList & list, telux::common::ResponseCallback callback = nullptr, bool resetToDefault = false ) [pure virtual]`

This API blacklists some constellations or subset of SVs from the constellation from being used by the GNSS standard position engine (SPE). Supported constellations for this API are GLONASS, QZSS, BEIDOU, GALILEO, SBAS and NAVIC. For other constellations NOTSUPPORTED status will be returned. For SBAS, SVs are not used in positioning by the GNSS standard position engine (SPE) by default. Blacklisting SBAS SV only blocks SBAS data demodulation and will not disable SBAS cross-correlation detection algorithms as they are necessary for optimal GNSS standard position engine (SPE) performance. When resetToDefault is false then the list is expected to contain the constellations or SVs that should be blacklisted. An empty list could be specified to allow all constellations/SVs (i.e. none will be blacklisted) in determining the fix. When resetToDefault is set to true, the device will revert to the default list of SV/ constellations to be blacklisted. For multiple invocations of this API, client should wait for the command to finish, e.g.: via ResponseCallback received before issuing a second configureConstellations command. Behavior is not defined if client issues a second request of configureConstellations without waiting for the finish of the previous configureConstellations request. This API call is not incremental and the new settings will completely overwrite the previous call.

On platforms with Access control enabled, caller needs to have TELUX\_LOC\_CONFIG permission to invoke this API successfully.

#### Parameters

in	<i>list</i>	- specify the set of constellations and SVs that should not be used by the GNSS engine on modem. Constellations and SVs not specified in blacklistedSvList could get used by the GNSS engine on modem.
in	<i>callback</i>	- Optional callback to get the response of configure constellations.
in	<i>resetToDefault</i>	- when set to true, the device will revert to the default list of SV/constellation to be blacklisted. When set to false, list will be inspected to determine what should be blacklisted.

#### 4.18.1.3.3.9 virtual telux::common::Status telux::loc::ILocationConfigurator::configureSecondaryBand ( const ConstellationSet & set, telux::common::ResponseCallback callback = nullptr ) [pure virtual]

This API configures the secondary band constellations used by the GNSS standard position engine. This API call is not incremental and the new settings will completely overwrite the previous call. The set specifies the supported constellations whose secondary band information should be disabled. The absence of a constellation in the set will result in the secondary band being enabled for that constellation. The modem has its own configuration in NV (persistent memory) about which constellation's secondary bands are allowed to be enabled. When a constellation is omitted when this API is invoked the secondary band for that constellation will only be enabled if the modem configuration allows it. If not allowed then this API would be a no-op for that constellation. Passing an empty set to this API will result in all constellations as allowed by the modem configuration to be enabled. For multiple invocations of this API, client should wait for the command to finish, e.g.: via ResponseCallback received, before issuing a second configureSecondaryBand command. Behavior is not defined if client issues a second request of configureSecondaryBand without waiting for the finish of the previous configureSecondaryBand request.

On platforms with Access control enabled, caller needs to have TELUX\_LOC\_CONFIG permission to invoke this API successfully.

#### Parameters

in	<i>set</i>	- specifies the set of constellations whose secondary bands need to be disabled.
in	<i>callback</i>	- Optional callback to get the response of configureSecondaryBand.

#### 4.18.1.3.3.10 virtual telux::common::Status telux::loc::ILocationConfigurator::requestSecondaryBandConfig ( GetSecondaryBandCallback cb ) [pure virtual]

This API retrieves the secondary band configurations for constellation used by the standard GNSS engine (SPE).

**Parameters**

in	<i>cb</i>	- callback to retrieve secondary band information about constellations.
----	-----------	---

**Returns**

Status of requestSecondaryBandConfig i.e. success or suitable status code.

**4.18.1.3.3.11 virtual telux::common::Status telux::loc::ILocationConfigurator::configureRobustLocation ( bool *enable*, bool *enableForE911* = *false*, telux::common::ResponseCallback *callback* = *nullptr* ) [pure virtual]**

This API enables/disables robust location 2.0 feature and enables/disables robust location while device is on E911. When this API is enabled it reports confidence of the GNSS spoofing by the getConformityIndex() API defined in the [ILocationInfoEx](#) class, which is a measure of robustness of the underlying navigation solution. It indicates how well the various input data considered for navigation solution conform to expectations. In the presence of detected spoofed inputs, the navigation solution may take corrective actions to mitigate the spoofed inputs and improve robustness of the solution.

On platforms with Access control enabled, caller needs to have TELUX\_LOC\_CONFIG permission to invoke this API successfully.

**Parameters**

in	<i>enable</i>	- true to enable robust location and false to disable robust location.
in	<i>enableForE911</i>	- true to enable robust location when the device is on E911 session and false to disable on E911 session. This parameter is only valid if robust location is enabled.
in	<i>callback</i>	- Optional callback to get the response of configure robust location.

**4.18.1.3.3.12 virtual telux::common::Status telux::loc::ILocationConfigurator::requestRobustLocation ( GetRobustLocationCallback *cb* ) [pure virtual]**

This API retrieves the robust location 2.0 settings and version info used by the GNSS standard position engine (SPE).

**Parameters**

in	<i>cb</i>	- callback to retrieve robust location information.
----	-----------	---

**Returns**

Status of requestRobustLocation i.e. success or suitable status code.

**4.18.1.3.3.13** `virtual telux::common::Status telux::loc::ILocationConfigurator::configureMinGpsWeek ( uint16_t minGpsWeek, telux::common::ResponseCallback callback = nullptr ) [pure virtual]`

This API configures the minimum GPS week used by the modem GNSS standard position engine (SPE) and shall not be called while GNSS SPE is in the middle of a session. Client needs to assure that there is no active GNSS SPE session prior to issuing this command. Client should wait for the command to finish, e.g.: via ResponseCallback received before issuing a second configureMinGpsWeek command. Behavior is not defined if client issues a second request of configureMinGpsWeek without waiting for the previous configureMinGpsWeek to finish. Additionally minimum GPS week number shall NEVER be in the future of the current GPS Week.

On platforms with Access control enabled, caller needs to have TELUX\_LOC\_CONFIG permission to invoke this API successfully.

#### Parameters

in	<i>minGpsWeek</i>	- minimum GPS week to be used by modem GNSS engine.
in	<i>callback</i>	- Optional callback to get the response of configure minimum GPS week.

#### Returns

Status of configureMinGpsWeek i.e. success or suitable status code.

**4.18.1.3.3.14** `virtual telux::common::Status telux::loc::ILocationConfigurator::requestMinGpsWeek ( GetMinGpsWeekCallback cb ) [pure virtual]`

This API retrieves the minimum GPS week configuration used by the modem GNSS standard position engine (SPE). If this API is called right after configureMinGpsWeek, the returned setting may not match the one specified in configureMinGpsWeek, as the setting configured via configureMinGpsWeek can not be applied to the GNSS standard position engine(SPE) when the engine is in middle of a session. In poor GPS signal condition, the session may take up to 255 seconds to finish. If after 255 seconds of invoking configureMinGpsWeek, the returned value still does not match, then the caller need to reapply the setting by invoking configureMinGpsWeek again.

#### Parameters

in	<i>cb</i>	- callback to retrieve the minimum gps week.
----	-----------	--

#### Returns

Status of requestMinGpsWeek i.e. success or suitable status code.

**4.18.1.3.3.15** `virtual telux::common::Status telux::loc::ILocationConfigurator::configureMinSVElevation ( uint8_t minSVElevation, telux::common::ResponseCallback callback = nullptr ) [pure virtual]`

This API configures the minimum SV elevation angle setting used by the GNSS standard position engine. Configuring minimum SV elevation setting will not cause SPE to stop tracking low elevation SVs. It only



controls the list of SVs that are used in the filtered position solution, so SVs with elevation below the setting will be excluded from use in the filtered position solution. Configuring this setting to large angle will cause more SVs to get filtered out in the filtered position solution and will have negative performance impact.

This setting does not impact the SV information and SV measurement reports retrieved from APIs such as `IGnssSvInfo::getSVInfoList`, `ILocationListener::onGnssMeasurementsInfo`.

To apply the setting, the GNSS standard position engine(SPE) will require GNSS measurement engine and position engine to be turned off briefly. This may cause glitch for on-going tracking session and may have other performance impact. So, it is advised to use this API with caution and only for very limited usage scenario, e.g.: for performance test and certification process and for one-time device configuration.

Client should wait for the command to finish, e.g.: via `ResponseCallback` received, before issuing a second `configureMinElevation` command. If this API is called while the GNSS Position Engine is in the middle of a session, `ResponseCallback` will still be invoked shortly to indicate the setting has been received by the SPE engine. However the actual setting can not be applied until the current session ends, and this may take up to 255 seconds in poor GPS signal condition.

On platforms with Access control enabled, caller needs to have `TELUX_LOC_CONFIG` permission to invoke this API successfully.

#### Parameters

in	<i>minSVElevation</i>	- minimum SV elevation to be used by GNSS standard position engine (SPE). Valid range is [0, 90] in unit of degree.
in	<i>callback</i>	- Optional callback to get the response of configure minimum SV Elevation angle.

#### Returns

Status of `configureMinSVElevation` i.e. success or suitable status code.

#### 4.18.1.3.3.16 virtual telux::common::Status telux::loc::ILocationConfigurator::requestMinSVElevation ( GetMinSVElevationCallback cb ) [pure virtual]

This API retrieves the minimum SV Elevation configuration used by the modem GNSS SPE engine. If this API is invoked right after the `configureMinSVElevation`, the returned setting may not match the one specified in `configureMinSVElevation`, as the setting received via `configureMinSVElevation` might not have been applied yet as it takes time to apply the setting if the GNSS SPE engine has an on-going session. In poor GPS signal condition, the session may take up to 255 seconds to finish. If after 255 seconds of invoking `configureMinSVElevation`, the returned value still does not match, then the caller need to reapply the setting by invoking `configureMinSVElevation` again.

#### Parameters

in	<i>cb</i>	- callback to retrieve the minimum SV elevation.
----	-----------	--

#### Returns

Status of `requestMinSVElevation` i.e. success or suitable status code.

**4.18.1.3.3.17** `virtual telux::common::Status telux::loc::ILocationConfigurator::deleteAidingData ( AidingData aidingDataMask, telux::common::ResponseCallback callback = nullptr ) [pure virtual]`

This API deletes specified aiding data from all position engines on the device. For example, removing ephemeris data may trigger GNSS engine to do a warm start. Invoking this API may cause noticeable delay for the position engine to produce first fix and may have other performance impact. So, this API should only be exercised with caution and only for very limited usage scenario, e.g.: for performance test and certification process.

On platforms with Access control enabled, caller needs to have TELUX\_LOC\_CONFIG permission to invoke this API successfully.

#### Parameters

in	<i>aidingDataMask</i>	- specify the set of aiding data to be deleted from all position engines. Currently, only ephemeris deletion is supported.
in	<i>callback</i>	- Optional callback to get the response of delete aiding data.

#### Returns

Status of deleteAidingData i.e. success or suitable status code.

**4.18.1.3.3.18** `virtual telux::common::Status telux::loc::ILocationConfigurator::configureDR ( const DREngineConfiguration & config, telux::common::ResponseCallback callback = nullptr ) [pure virtual]`

This API configures various parameters for dead reckoning position engine. Clients should wait for the command to finish e.g.: via ResponseCallback to be received before issuing a second configureDR command. Behavior is not defined if client issues a second request of configureDR without waiting for the completion of the previous configureDR request.

On platforms with Access control enabled, caller needs to have TELUX\_LOC\_CONFIG permission to invoke this API successfully.

#### Parameters

in	<i>config</i>	- specify dead reckoning engine configuration.
in	<i>callback</i>	- Optional callback to get the response of configureDR.

#### Returns

Status of configureDR i.e. success or suitable status code.

**4.18.1.3.3.19** `virtual telux::common::Status telux::loc::ILocationConfigurator::configureEngineState ( const EngineType engineType, const LocationEngineRunState engineState, telux::common::ResponseCallback callback = nullptr ) [pure virtual]`

This API is used to instruct the specified engine to be in the suspended/running state. When the engine is placed in suspended state, the engine will stop. If there is an on-going session, engine will no longer

produce fixes. In the suspended state, calling API to delete aiding data from the paused engine may not have effect. Request to delete Aiding data shall be issued after engine resume.

Currently, only DR engine will support this request. The request to suspend/running DR engine can be made with or without an on-going session. With DR engine, on resume, GNSS position & heading re-acquisition may be needed for DR to engage.

On platforms with Access control enabled, caller needs to have TELUX\_LOC\_CONFIG permission to invoke this API successfully.

### Parameters

in	<i>engineType</i>	- the engine that is instructed to change its run state.
in	<i>engineState</i>	- the new engine run state that the engine is instructed to be in.
in	<i>callback</i>	- Optional callback to get the response of configureEngineState.

### Returns

Status of configureEngineState i.e. success or suitable status code.

**4.18.1.3.3.20** `virtual telux::common::Status telux::loc::ILocationConfigurator::provideConsentForTerrestrialPositioning ( bool userConsent, telux::common::ResponseCallback callback = nullptr ) [pure virtual]`

Clients can request Terrestrial Positioning using [ILocationManager::getTerrestrialPosition](#). Terrestrial Positioning requires sending device data to the cloud to get the position. This functionality requires user consent. This API needs to be invoked to provide the user consent.

The consent will remain effective across power cycles, until this API is called with a different value.

On platforms with Access control enabled, caller needs to have TELUX\_LOC\_CONSENT permission to invoke this API successfully.

### Parameters

in	<i>userConsent</i>	- true indicates user consents to sending device data to cloud, false indicates user does not consent.
in	<i>callback</i>	- Optional callback to get the response of provideConsentForTerrestrialPositioning.

### Returns

Status of provideConsentForTerrestrialPositioning i.e. success or suitable status code.

**4.18.1.3.3.21** `virtual telux::common::Status telux::loc::ILocationConfigurator::configureNmeaTypes ( const NmeaSentenceConfig nmeaType, telux::common::ResponseCallback callback = nullptr ) [pure virtual]`

This API is used to configure the NMEA sentence types that clients will receive via [ILocationManager::startDetailedReports](#) or [ILocationManager::startDetailedEngineReports](#). Without prior invocation to this API, all NMEA sentences supported in the system will get generated and delivered to all

the clients that register to receive NMEA sentences. The NMEA sentence type configuration is common across all clients and updating it will affect all clients. This API call is not incremental and the new NMEA sentence types will completely overwrite the previous call to this API.

On platforms with Access control enabled, caller needs to have TELUX\_LOC\_CONFIG permission to invoke this API successfully.

### Parameters

in	<i>nmeaType</i>	- specify the set of NMEA sentences
in	<i>callback</i>	- Optional callback to get the response of configureNmeaTypes.

### Returns

Status of configureNmeaTypes i.e. success or suitable status code.

**4.18.1.3.3.22 virtual telux::common::Status telux::loc::ILocationConfigurator::configureNmea ( const NmeaConfig *configParams*, telux::common::ResponseCallback *callback* = nullptr ) [pure virtual]**

This API is used to configure the NMEA sentences that the clients will receive via [ILocationListener](#) class APIs. NMEA updates can be received by either: a) Setting the telux::loc::GnssReportType::NMEA bit in the reportMask passed as a paramter to [ILocationManager::startDetailedReports](#) OR [ILocationManager::startDetailedEngineReports](#) and receive the sentences via [ILocationListener::onGnssNmeaInfo](#). b) Setting the telux::loc::GnssReportType::ENGINE\_NMEA bit in the reportMask passed as a paramter to [ILocationManager::startDetailedEngineReports](#) and receive the sentences via [ILocationListener::onEngineNmeaInfo](#).

Further, the engines from which NMEA sentences will be received depends on the configuration made through this API AND the engine types chosen when starting the position reports via [ILocationManager::startDetailedEngineReports](#). Fused engine is always considered as set even if the client does not explicitly specify it.

Without prior invocation to this API, all NMEA sentences supported in the system will get generated and delivered to all the clients that register to receive NMEA sentences. The NMEA sentence type configuration is common across all clients and updating it will affect all clients.

Please note that for the NMEA datum type request to be successful, the nmea provider configuration in the GPS configuration file should be set to application processor.

This API call is not incremental and the new NMEA configuration will completely overwrite the previous call to this API.

Also refer to [ILocationManager::startDetailedEngineReports](#) to understand the types of NMEA updates to be received.

### Parameters

in	<i>configParams</i>	- Configuration Parameters for Nmea on the device.
in	<i>callback</i>	- Optional callback to get the response of configureNmea.

## Returns

Status of configureNmea i.e. success or suitable status code.

## Note

Eval: This is a new API and is being evaluated. It is subject to change and could break backwards compatibility.

**4.18.1.3.3.23 virtual telux::common::Status telux::loc::ILocationConfigurator::configure↔  
EngineIntegrityRisk ( const EngineType *engineType*, uint32\_t *integrityRisk*,  
telux::common::ResponseCallback *callback* = nullptr ) [pure virtual]**

This API is used to instruct the specified engine to use the provided integrity risk level for protection level calculation in position report. This API can be called when a position session is in progress. Prior to calling this API for a particular engine, the engine shall not calculate the protection levels and shall not include the protection levels in its position report. The implementation might not support protection levels across all engines. For engines that don't support it, [telux::common::ResponseCallback](#) will get invoked with [telux::common::ErrorCode::NOT\\_SUPPORTED](#).

On platforms with Access control enabled, caller needs to have TELUX\_LOC\_CONFIG permission to invoke this API successfully.

## Parameters

in	<i>engineType</i>	- the engine that is instructed to use the specified integrity risk level for protection level calculation.
in	<i>integrityRisk</i>	- the integrity risk level used for calculating protection level. The integrity risk is defined as a probability per epoch, in unit of 2.5e-10. The valid range for actual integrity is [2.5e-10, 1-2.5e-10]), this corresponds to range of [1,4e9-1] of this parameter.
in	<i>callback</i>	- Optional callback to get the response of configureEngineIntegrityRisk.

## Returns

Status of configureEngineIntegrityRisk i.e. success or suitable status code.

**4.18.1.3.3.24 virtual telux::common::Status telux::loc::ILocationConfigurator::configureXtraParams ( bool *enable*, const XtraConfig *configParams*, telux::common::ResponseCallback *callback* = nullptr ) [pure virtual]**

This API is used to enable/disable the XTRA (Predicted GNSS Satellite Orbit Data) feature on device. If XTRA feature is to be enabled, this API is also used to configure the various XTRA settings in device.

Clients need to note the below-

1. Wait for the ongoing request to finish prior to the next invocation else the behavior is undefined.
2. The API is non-incremental i.e. the second call will overwrite the first call. Also the configured

XTRA params will be persistent.

On platforms with Access control enabled, caller needs to have TELUX\_LOC\_CONFIG permission to invoke this API successfully.

#### Parameters

in	<i>enable</i>	- Enable XTRA Feature on the device. False would disable both the XTRA Assistance Data and NTP Time Download.
in	<i>configParams</i>	- Configuration Parameters for XTRA on the device.
in	<i>callback</i>	- Optional callback stating the response errorcode.

#### 4.18.1.3.3.25 virtual telux::common::Status telux::loc::ILocationConfigurator::requestXtraStatus ( GetXtraStatusCallback *callback* ) [pure virtual]

This API is used to query xtra feature setting and xtra assistance data status used by the GNSS standard position engine (SPE). If XTRA\_DATA\_STATUS\_UNKNOWN is returned but XTRA feature is enabled, the client shall wait a few seconds before calling this API again.

#### Parameters

in	<i>callback</i>	- Callback to get the Xtra data status information.
----	-----------------	---

#### 4.18.1.3.3.26 virtual telux::common::Status telux::loc::ILocationConfigurator::registerListener ( LocConfigIndications *indicationList*, std::weak\_ptr< ILocationConfigListener > *listener* ) [pure virtual]

This API is used to register a configuration listener for getting specific indications/updates.

#### Parameters

in	<i>indicationList</i>	- List of indications client wants to register under <a href="#">telux::loc::LocConfigIndicationsType</a> .
in	<i>listener</i>	- Pointer of <a href="#">ILocationConfigListener</a> object.

#### 4.18.1.3.3.27 virtual telux::common::Status telux::loc::ILocationConfigurator::deRegisterListener ( LocConfigIndications *indicationList*, std::weak\_ptr< ILocationConfigListener > *listener* ) [pure virtual]

This API is used to deregister a configuration listener from specific indications/updates.

#### Parameters

in	<i>indicationList</i>	- List of indications client wants to deregister from under <a href="#">telux::loc::LocConfigIndicationsType</a> .
in	<i>listener</i>	- Pointer of <a href="#">ILocationConfigListener</a> object.

**4.18.1.3.3.28** `virtual telux::common::Status telux::loc::ILocationConfigurator::injectMerkleTree↔  
Information ( std::string merkleTreeInfo, telux::common::ResponseCallback callback =  
nullptr ) [pure virtual]`

To support the Galileo OSNMA feature, this API is used to inject the Merkle Tree information via a XML configuration file. The XML configuration contains the Merkle root, Merkle nodes and information for upto 2 public keys.

On platforms with Access control enabled, caller needs to have TELUX\_LOC\_CONFIG permission to invoke this API successfully.

#### Parameters

in	<i>merkleTreeInfo</i>	- The XML content to be injected. For injecting the Merkle information, clients need to pass the XML content in the form of a std::string.
in	<i>callback</i>	- Optional callback to receive the result of the injection.

#### Returns

Status of the injection i.e. success or suitable status code.

**4.18.1.3.3.29** `virtual telux::common::Status telux::loc::ILocationConfigurator::configureOsnma ( bool  
enable, telux::common::ResponseCallback callback = nullptr ) [pure virtual]`

This API is used to enable/disable the OSNMA Feature in the Modem.

On platforms with Access control enabled, caller needs to have TELUX\_LOC\_CONFIG permission to invoke this API successfully.

#### Parameters

in	<i>enable</i>	- Enable/Disable the OSNMA Feature in the modem.
in	<i>callback</i>	- Optional callback to receive the result of the enablement/disablement.

#### Returns

Status of the enablement/disablement i.e. success or suitable status code.

### 4.18.1.4 struct telux::loc::GnssKinematicsData

Specifies kinematics related information related to device body frame parameters.

#### Data fields

Type	Field	Description
<a href="#">Kinematic↔ DataValidity</a>	<code>bodyFrame↔ DataMask</code>	Contains Body frame data valid bits.
float	<code>longAccel</code>	Forward Acceleration in body frame (meters/second <sup>2</sup> )

Type	Field	Description
float	latAccel	Sideward Acceleration in body frame (meters/second <sup>2</sup> )
float	vertAccel	Vertical Acceleration in body frame (meters/second <sup>2</sup> )
float	yawRate	Heading Rate (Radians/second)
float	pitch	Body pitch (Radians)
float	longAccelUnc	Uncertainty of Forward Acceleration in body frame (meters/second <sup>2</sup> ) Uncertainty is defined with 68% confidence level.
float	latAccelUnc	Uncertainty of Side-ward Acceleration in body frame meters/second <sup>2</sup> ) Uncertainty is defined with 68% confidence level.
float	vertAccelUnc	Uncertainty of Vertical Acceleration in body frame (meters/second <sup>2</sup> ) Uncertainty is defined with 68% confidence level.
float	yawRateUnc	Uncertainty of Heading Rate (Radians/second) Uncertainty is defined with 68% confidence level.
float	pitchUnc	Uncertainty of Body pitch (Radians) Uncertainty is defined with 68% confidence level.
float	pitchRate	Body pitch rate, in unit of radians/second.
float	pitchRateUnc	Uncertainty of pitch rate, in unit of radians/second. Uncertainty is defined with 68% confidence level.
float	roll	Roll of body frame, clockwise is positive, in unit of radian.
float	rollUnc	Uncertainty of roll, in unit of radian. Uncertainty is defined with 68% confidence level.
float	rollRate	Roll rate of body frame, clockwise is positive, in unit of radian/second.
float	rollRateUnc	Uncertainty of roll rate, in unit of radian/second. Uncertainty is defined with 68% confidence level.
float	yaw	Yaw of body frame, clockwise is positive, in unit of radian.
float	yawUnc	Uncertainty of yaw, in unit of radian. Uncertainty is defined with 68% confidence level.

#### 4.18.1.5 struct telux::loc::LLAInfo

The location info is calculated according to the vehicle's GNSS antenna where as Vehicle Reference Point(VRP) refers to a point on the vehicle where the display of the car sits. The VRP based info is calculated by adding that extra difference between GNSS antenna and the VRP on the top where the location info is recieved. The VRP parameters can be configured through [ILocationConfigurator::configureLeverArm](#). **LLAInfo** specifies latitude, longitude and altitude info of location for VRP-based.

##### Data fields

Type	Field	Description
double	latitude	Latitude, in unit of degrees, range [-90.0, 90.0].
double	longitude	Longitude, in unit of degrees, range [-180.0, 180.0].
float	altitude	Altitude above the WGS 84 reference ellipsoid, in unit of meters.



#### 4.18.1.6 struct telux::loc::TimeInfo

Specify non-Glonass Gns system time info.

##### Data fields

Type	Field	Description
<a href="#">GnsTime</a> ↔ <a href="#">Validity</a>	validityMask	Validity mask for below fields
uint16_t	systemWeek	Extended week number at reference tick. Unit: Week. Set to 65535 if week number is unknown. For GPS: Calculated from midnight, Jan. 6, 1980. OTA decoded 10 bit GPS week is extended to map between: [NV6264 to (NV6264 + 1023)]. For BDS: Calculated from 00:00:00 on January 1, 2006 of Coordinated Universal Time (UTC). For GAL: Calculated from 00:00 UT on Sunday August 22, 1999 (midnight between August 21 and August 22).
uint32_t	systemMsec	Time in to the current week at reference tick. Unit: Millisecond. Range: 0 to 604799999.
float	systemClk↔ TimeBias	System clock time bias Units: Millisecond Note: System time (TOW Millisecond) = systemMsec - systemClkTimeBias.
float	systemClk↔ TimeUncMs	Single sided maximum time bias uncertainty Units: Millisecond
uint32_t	refFCount	FCount (free running HW timer) value. Don't use for relative time purpose due to possible discontinuities. Unit: Millisecond
uint32_t	numClock↔ Resets	Number of clock resets/discontinuities detected, affecting the local hardware counter value.

#### 4.18.1.7 struct telux::loc::GlonassTimeInfo

Specifies Glonass system time info.

##### Data fields

Type	Field	Description
uint16_t	gloDays	GLONASS day number in four years. Refer to GLONASS ICD. Applicable only for GLONASS and shall be ignored for other constellations. If unknown shall be set to 65535
<a href="#">TimeValidity</a>	validityMask	Validity mask for <a href="#">GlonassTimeInfo</a> fields
uint32_t	gloMsec	GLONASS time of day in Millisecond. Refer to GLONASS ICD. Units: Millisecond.
float	gloClkTime↔ Bias	GLONASS clock time bias. Units: Millisecond Note: GLO time (TOD Millisecond) = gloMsec - gloClkTimeBias. Check for gloClkTimeUncMs before use.
float	gloClkTime↔ UncMs	Single sided maximum time bias uncertainty Units: Millisecond
uint32_t	refFCount	FCount (free running HW timer) value. Don't use for relative time purpose due to possible discontinuities. Unit: Millisecond
uint32_t	numClock↔ Resets	Number of clock resets/discontinuities detected, affecting the local hardware counter value.

Type	Field	Description
uint8_t	gloFourYear	GLONASS four year number from 1996. Refer to GLONASS ICD. Applicable only for GLONASS and shall be ignored for other constellations.

#### 4.18.1.8 union telux::loc::SystemTimeInfo

Union to hold GNSS system time from different constellations in [SystemTime](#).

##### Data fields

Type	Field	Description
<a href="#">TimeInfo</a>	gps	System time info from GPS constellation.
<a href="#">TimeInfo</a>	gal	System time info from GALILEO constellation.
<a href="#">TimeInfo</a>	bds	System time info from BEIDOU constellation.
<a href="#">TimeInfo</a>	qzss	System time info from QZSS constellation.
<a href="#">GlonassTimeInfo</a>	glo	System time info from GLONASS constellation.
<a href="#">TimeInfo</a>	navic	System time info from NAVIC constellation.

#### 4.18.1.9 struct telux::loc::SystemTime

GNSS system time in [ILocationInfoEx](#).

##### Data fields

Type	Field	Description
<a href="#">GnssSystem</a>	gnssSystem↔ TimeSrc	Specify the source constellation for GNSS system time.
<a href="#">SystemTimeInfo</a>	time	Specify the GNSS system time corresponding to the source.

#### 4.18.1.10 struct telux::loc::GnssMeasurementInfo

Specify the satellite vehicle measurements that are used to calculate location in [ILocationInfoEx](#).

##### Data fields

Type	Field	Description
<a href="#">GnssSignal</a>	gnssSignalType	GnssSignalType mask
<a href="#">GnssSystem</a>	gnss↔ Constellation	Specifies GNSS Constellation Type
uint16_t	gnssSvId	GNSS SV ID. For GPS: 1 to 32. For GLONASS: [65, 96] or [97, 110]. [65, 96] if orbital slot number(OSN) is known. [97, 110] as frequency channel number(FCN) [-7, 6] plus 104. i.e. encode FCN (-7) as 97, FCN (0) as 104, FCN (6) as 110. For SBAS: 120 to 158 and 183 to 191. For QZSS: 193 to 197. For BDS: 201 to 263. For GAL: 301 to 336. For NAVIC: 401 to 414.

#### 4.18.1.11 struct telux::loc::SvUsedInPosition

Specify the set of SVs that are used to calculate location in [ILocationInfoEx](#).

##### Data fields

Type	Field	Description
uint64_t	gps	Specify the set of SVs from GPS constellation that are used to compute the position. Bit 0 to Bit 31 corresponds to GPS SV id 1 to 32.
uint64_t	glo	Specify the set of SVs from GLONASS constellation that are used to compute the position. Bit 0 to Bit 31 corresponds to GLO SV id 65 to 96.
uint64_t	gal	Specify the set of SVs from GALILEO constellation that are used to compute the position. Bit 0 to Bit 35 corresponds to GAL SV id 301 to 336.
uint64_t	bds	Specify the set of SVs from BEIDOU constellation that are used to compute the position. Bit 0 to Bit 62 corresponds to BDS SV id 201 to 263.
uint64_t	qzss	Specify the set of SVs from QZSS constellation that are used to compute the position. Bit 0 to Bit 4 corresponds to QZSS SV id 193 to 197.
uint64_t	navic	Specify the set of SVs from NAVIC constellation that are used to compute the position. Bit 0 to Bit 13 corresponds to NAVIC SV id 401 to 414.

#### 4.18.1.12 struct telux::loc::GnssData

Specify the additional GNSS data that can be provided during a tracking session, currently jammer and automatic gain control data are available.

##### Data fields

Type	Field	Description
<a href="#">GnssData</a> ↔ <a href="#">Validity</a>	gnssData↔ Mask[Gnss↔ DataSignal↔ Types::GNSS↔ _DATA_MA↔ X_NUMBER↔ _OF_SIGNA↔ L_TYPES]	bitwise OR of GnssDataValidityType
double	jammer↔ Ind[GnssData↔ SignalTypes::↔ GNSS_DAT↔ A_MAX_NU↔ MBER_OF_↔ SIGNAL_TY↔ PES]	Jammer Indication for each signal type. Each index represents the signal type in GnssDataSignalTypes.

Type	Field	Description
double	agc[Gnss↔ DataSignal↔ Types::GNSS↔ _DATA_MA↔ X_NUMBER↔ _OF_SIGNA↔ L_TYPES]	Automatic gain control for each signal type. Each index corresponds to the signal type in GnssDataSignalTypes.

#### 4.18.1.13 struct telux::loc::SvBlackListInfo

Specify parameters related to enable/disable SVs

##### Data fields

Type	Field	Description
<a href="#">Gnss↔ Constellation↔ Type</a>	constellation	constellation for the sv
uint32_t	svId	sv id for the constellation: 0 means blacklist for all SVIds of a given constellation type GLONASS SV id range: 65 to 96 QZSS SV id range: 193 to 197 BDS SV id range: 201 to 237 GAL SV id range: 301 to 336 SBAS SV id range: 120 to 158 and 183 to 191 NAVIC SV id range: 401 to 414

#### 4.18.1.14 struct telux::loc::LeverArmParams

Specify parameters related to lever arm

##### Data fields

Type	Field	Description
float	forwardOffset	Offset along the vehicle forward axis, in unit of meters
float	sidewaysOffset	Offset along the vehicle starboard axis, in unit of meters
float	upOffset	Offset along the vehicle up axis, in unit of meters

#### 4.18.1.15 struct telux::loc::GnssMeasurementsData

Specify the signal measurement information such as satellite vehicle pseudo range, satellite vehicle time, carrier phase measurement etc. from GNSS positioning engine.

##### Data fields

Type	Field	Description
<a href="#">Gnss↔ Measurements↔ DataValidity</a>	valid	Bitwise OR of GnssMeasurementsDataValidityType to specify the valid fields in <a href="#">GnssMeasurementsData</a> .
int16_t	svId	Specify satellite vehicle ID number.

Type	Field	Description
<a href="#">Gnss↔ Constellation↔ Type</a>	svType	SV constellation type.
double	timeOffsetNs	Time offset when the measurement was taken, in unit of nanoseconds.
<a href="#">Gnss↔ Measurements↔ StateValidity</a>	stateMask	Bitwise OR of GnssMeasurementsStateValidityType to specify the GNSS measurement state.
int64_t	receivedSv↔ TimeNs	Received GNSS time of the week in nanoseconds when the measurement was taken. Total time is: receivedSvTimeNs+receivedSvTimeSubNs.
float	receivedSv↔ TimeSubNs	Sub nanoseconds portion of the received GNSS time of the week when the measurement was taken. Total time is: receivedSvTimeNs+receivedSvTimeSubNs.
int64_t	receivedSv↔ Time↔ UncertaintyNs	Satellite time. All SV times in the current measurement block are already propagated to a common reference time epoch, in unit of nano seconds.
double	carrierTo↔ NoiseDbHz	Signal strength, carrier to noise ratio, in unit of dB-Hz.
double	pseudorange↔ RateMps	Uncorrected pseudorange rate, in unit of metres/second.
double	pseudorange↔ Rate↔ Uncertainty↔ Mps	Uncorrected pseudorange rate uncertainty, in unit of meters/second.
<a href="#">Gnss↔ Measurements↔ AdrState↔ Validity</a>	adrStateMask	Bitwise OR of GnssMeasurementsAdrStateValidityType.
double	adrMeters	Accumulated delta range, in unit of meters.
double	adr↔ Uncertainty↔ Meters	Accumulated delta range uncertainty, in unit of meters.
float	carrier↔ FrequencyHz	Carrier frequency of the tracked signal, in unit of Hertz.
int64_t	carrierCycles	The number of full carrier cycles between the receiver and the satellite.
double	carrierPhase	The RF carrier phase that the receiver has detected.
double	carrierPhase↔ Uncertainty	The RF carrier phase uncertainty.
<a href="#">Gnss↔ Measurements↔ Multipath↔ Indicator</a>	multipath↔ Indicator	Multipath indicator, could be unknown, present or not present.
double	signalTo↔ NoiseRatioDb	Signal to noise ratio, in unit of dB.
double	agcLevelDb	Automatic gain control level, in unit of dB.
<a href="#">GnssSignal</a>	gnssSignalType	GnssSignalType mask

Type	Field	Description
double	baseband↔ CarrierToNoise	Carrier-to-noise ratio of the signal measured at baseband, in unit of dB-Hz.
double	fullInter↔ SignalBias	The full inter-signal bias (ISB) in nanoseconds. This value is the sum of the estimated receiver-side and the space-segment-side inter-system bias, inter-frequency bias and inter-code bias.
double	fullInter↔ SignalBias↔ Uncertainty	Uncertainty associated with the full inter-signal bias in nanoseconds.

#### 4.18.1.16 struct telux::loc::GnssMeasurementsClock

Specify GNSS measurements clock. The main equation describing the relationship between various components is:  $utcTimeNs = timeNs - (fullBiasNs + biasNs) - leapSecond * 1,000,000,000$

##### Data fields

Type	Field	Description
Gnss↔ Measurements↔ ClockValidity	valid	Bitwise OR of GnssMeasurementsClockValidityType.
int16_t	leapSecond	Leap second, in unit of seconds.
int64_t	timeNs	Time, monotonically increasing as long as the power is on, in unit of nanoseconds.
double	time↔ UncertaintyNs	Time uncertainty (one sigma), in unit of nanoseconds.
int64_t	fullBiasNs	Full bias, in unit of nanoseconds.
double	biasNs	Sub-nanoseconds bias, in unit of nanoseconds.
double	bias↔ UncertaintyNs	Bias uncertainty (one sigma), in unit of nanoseconds.
double	driftNsps	Clock drift, in unit of nanoseconds/second.
double	drift↔ Uncertainty↔ Nsps	Clock drift uncertainty (one sigma), in unit of nanoseconds/second.
uint32_t	hwClock↔ Discontinuity↔ Count	HW clock discontinuity count - incremented for each discontinuity in HW clock.

#### 4.18.1.17 struct telux::loc::GnssMeasurements

Specify GNSS measurements clock and data. [GnssMeasurementInfo](#) is used to convey the satellite vehicle info whose measurements are actually used to generate the current position report. While [GnssMeasurements](#) contains the satellite measurements that device observed during tracking session, regardless the measurement is used or not used to compute the fix. Furthermore [GnssMeasurements](#) contains much richer set of information which can enable other third party engines to utilize the measurements and compute the position by itself.

**Data fields**

Type	Field	Description
<a href="#">Gnss↔ Measurements↔ Clock</a>	clock	GNSS measurements clock info.
vector< <a href="#">Gnss↔ Measurements↔ Data</a> >	measurements	GNSS measurements data.
bool	isNHz	Indicates the frequency for GNSS measurements generated at NHz or not.

**4.18.1.18 struct telux::loc::GnssDisasterCrisisReport**

Specify the Disaster-crisis type and data payload received from the GNSS engine.

**Data fields**

Type	Field	Description
<a href="#">GnssReportD↔ CType</a>	dcReportType	Disaster and crisis report types supported by the GNSS Engine.
vector< uint8↔ _t >	dcReportData	The disaster crisis report data, packed into uint8_t. The bits in the payload are packed w.r.t the MSB First ordering.
uint16_t	numValidBits	Number of valid bits that client should use in the payload as per the dcReportData.

**4.18.1.19 struct telux::loc::LeapSecondChangeInfo**

Specify leap second change event info.

**Data fields**

Type	Field	Description
<a href="#">TimeInfo</a>	timeInfo	GPS timestamp that corresponds to the last known leap second change event. The info can be available on two scenario: 1: This leap second change event has been scheduled and yet to happen 2: This leap second change event has already happened and next leap second change event has not yet been scheduled.
uint8_t	leapSeconds↔ BeforeChange	Number of leap seconds prior to the leap second change event that corresponds to the timestamp at timeInfo.
uint8_t	leapSeconds↔ AfterChange	Number of leap seconds after the leap second change event that corresponds to the timestamp at timeInfo.

**4.18.1.20 struct telux::loc::LeapSecondInfo**

Specify leap second info, including current leap second and leap second change event info if available.

**Data fields**

Type	Field	Description
<a href="#">LeapSecondInfoValidity</a>	valid	Validity of <a href="#">LeapSecondInfo</a> fields.
uint8_t	current	Current leap seconds, in unit of seconds. This info will only be available only if the leap second change info is not available.
<a href="#">LeapSecondChangeInfo</a>	info	Leap second change event info. The info can be available on two scenario: 1: this leap second change event has been scheduled and yet to happen 2: this leap second change event has already happened and next leap second change event has not yet been scheduled. If leap second change info is available, to figure out the current leap second info, compare current gps time with <a href="#">LeapSecondChangeInfo::timeInfo</a> to know whether to choose <a href="#">LeapSecondBefore</a> or <a href="#">LeapSecondAfter</a> as current leap second.

**4.18.1.21 struct telux::loc::LocationSystemInfo**

Specify location system information.

**Data fields**

Type	Field	Description
<a href="#">LocationSystemInfoValidity</a>	valid	validity of <a href="#">LocationSystemInfo::info</a>
<a href="#">LeapSecondInfo</a>	info	Current leap second and leap second info.

**4.18.1.22 struct telux::loc::GnssEnergyConsumedInfo**

Specify the info regarding energy consumed by GNSS engine.

**Data fields**

Type	Field	Description
<a href="#">GnssEnergyConsumedInfoValidity</a>	valid	Bitwise OR of <a href="#">GnssEnergyConsumedInfoValidityType</a> to specify the valid fields in <a href="#">GnssEnergyConsumedInfo</a> .
uint64_t	<a href="#">energySinceFirstBoot</a>	Energy consumed by the modem GNSS engine since device first ever bootup, in unit of 0.1 milli watt seconds. For an invalid reading, <code>INVALID_ENERGY_CONSUMED</code> is returned.

**4.18.1.23 struct telux::loc::NmeaConfig**

Specify the Nmea Config Parameters



**Data fields**

Type	Field	Description
<a href="#">Nmea</a> ↔ <a href="#">SentenceConfig</a>	sentenceConfig	Specify the sentences to be configured.
<a href="#">Geodetic</a> ↔ <a href="#">DatumType</a>	datumType	Specify the datum type to be configured.
<a href="#">LocReqEngine</a>	engineType	Specify the Engine type for which Nmea sentences should be generated. Also refer to <a href="#">ILocationConfigurator::configureNmea</a> and <a href="#">ILocationManager::startDetailedEngineReports</a> to understand the usage further.

**4.18.1.24 struct telux::loc::RobustLocationVersion**

Specify the versioning info of robust location module for the GNSS standard position engine (SPE).

**Data fields**

Type	Field	Description
uint8_t	major	Major version number.
uint16_t	minor	Minor version number.

**4.18.1.25 struct telux::loc::RobustLocationConfiguration**

Specify the robust location configuration used by the GNSS standard position engine (SPE)

**Data fields**

Type	Field	Description
<a href="#">Robust</a> ↔ <a href="#">LocationConfig</a>	validMask	Validity mask
bool	enabled	Specify whether robust location feature is enabled or not.
bool	enabledFor↔ E911	Specify whether robust location feature is enabled or not when device is on E911 call.
<a href="#">Robust</a> ↔ <a href="#">Location</a> ↔ <a href="#">Version</a>	version	Specify the version info of robust location module used by the GNSS standard position engine (SPE).

**4.18.1.26 struct telux::loc::BodyToSensorMountParams**

Specify vehicle body-to-Sensor mount parameters for use by dead reckoning positioning engine.

**Data fields**

Type	Field	Description
float	rollOffset	The misalignment of the sensor board along the horizontal plane of the vehicle chassis measured looking from the vehicle to forward direction. In unit of degrees. Range: [-180.0, 180.0].

Type	Field	Description
float	yawOffset	The misalignment along the horizontal plane of the vehicle chassis measured looking from the vehicle to the right side. Positive pitch indicates vehicle is inclined such that forward wheels are at higher elevation than rear wheels. In unit of degrees. Range: [-180.0, 180.0].
float	pitchOffset	The angle between the vehicle forward direction and the sensor axis as seen from the top of the vehicle, and measured in counterclockwise direction. In unit of degrees. Range: [-180.0, 180.0].
float	offsetUnc	Single uncertainty number that may be the largest of the uncertainties for roll offset, pitch offset and yaw offset. In unit of degrees. Range: [-180.0, 180.0].

#### 4.18.1.27 struct telux::loc::DREngineConfiguration

Specify the dead reckoning engine configuration parameters.

##### Data fields

Type	Field	Description
<a href="#">DRConfig</a> ↔ <a href="#">Validity</a>	validMask	Specify the valid fields.
<a href="#">BodyTo</a> ↔ <a href="#">SensorMount</a> ↔ <a href="#">Params</a>	mountParam	Body to sensor mount parameters used by dead reckoning positioning engine.
float	speedFactor	Vehicle Speed Scale Factor configuration input for the dead reckoning positioning engine. The multiplicative scale factor is applied to the received Vehicle Speed value (in meter/second) to obtain the true Vehicle Speed. Range is [0.9 to 1.1]. Note: The scale factor is specific to a given vehicle make & model.
float	speedFactor↔ Unc	Vehicle Speed Scale Factor Uncertainty (68% confidence) configuration input for the dead reckoning positioning engine. Range is [0.0 to 0.1]. Note: The scale factor uncertainty is specific to a given vehicle make & model.
float	gyroFactor	Gyroscope Scale Factor configuration input for the dead reckoning positioning engine. The multiplicative scale factor is applied to received gyroscope value to obtain the true value. Range is [0.9 to 1.1]. Note: The scale factor is specific to the Gyroscope sensor and typically derived from either sensor data-sheet or from actual calibration.
float	gyroFactorUnc	Gyroscope Scale Factor uncertainty (68% confidence) configuration input for the dead reckoning positioning engine. Range is [0.0 to 0.1]. Note: The scale factor uncertainty is specific to the Gyroscope sensor and typically derived from either sensor data-sheet or from actual calibration.

### 4.18.1.28 struct telux::loc::XtraConfig

Xtra feature configuration parameters

#### Data fields

Type	Field	Description
uint32_t	download↔ IntervalMinute	Number of minutes between periodic, consecutive successful XTRA assistance data downloads.  If 0 is specified, modem default download for XTRA assistance data will be performed.
uint32_t	download↔ TimeoutSec	Connection timeout when connecting backend for both xtra assistance data download and NTP time download.  If 0 is specified, the download timeout value will use device default values.
uint32_t	download↔ RetryInterval↔ Minute	Interval to wait before retrying for xtra assistance data's download in case of failure.  If 0 is specified, XTRA download retry will follow device default behavior and downloadRetryAttempts will also use device default value.
uint32_t	download↔ RetryAttempts	Total number of allowed retry attempts for assistance data's download in case of failure.  If 0 is specified, XTRA download retry will follow device default behavior and downloadRetryIntervalMinute will also use device default value.
string	caPath	Path to the certificate authority (CA) repository that needs to be used for XTRA assistance data download. If empty string is specified, device default CA repository will be used.
vector< string >	serverURLs	URLs from which XTRA assistance data will be fetched. At least one and up to three URLs need to be configured when this API is used.  The URLs, if provided, shall include the port number to be used for download.  Valid xtra server URLs should start with "https://".  Example of a valid URL : <a href="https://path.exampleserver.net:443">https://path.exampleserver.net:443</a>
vector< string >	ntpServerURLs	URLs for NTP server to fetch current time.  If no NTP server URL is provided, then device will use the default NTP server.  The URLs, if provided, shall include the port number to be used for download.  Example of a valid ntp server URL is: ntp.exampleserver.com:123.
bool	isIntegrity↔ Download↔ Enabled	Enable or disable XTRA integrity download.  true: enable XTRA integrity download. false: disable XTRA integrity download.

Type	Field	Description
uint32_t	integrity↔ Download↔ IntervalMinute	Download interval for xtra integrity, only applicable if XTRA integrity download is enabled. If 0 is specified, the download timeout value will use device default value.
<a href="#">DebugLog↔ Level</a>	daemon↔ DebugLog↔ Level	Level of debug log messages that will be logged.
string	ntsServerURL	URL of NTS KE Server. The URL, if provided, shall be complete and shall include the port number. Max of 128 bytes, including null-terminating byte will be supported. Valid NTS KE server URL should start with "https://". If NTS KE server URL is not specified, then device will use the default URL of <a href="https://nts.xtracloud.net:4460">https://nts.xtracloud.net:4460</a> .
bool	isDiag↔ Logging↔ Enabled	Enable or disable diag logging for Xtra. false : disable the diag logging for Xtra. true : enable the diag logging for Xtra.

#### 4.18.1.29 struct telux::loc::XtraStatus

Specify Xtra assistant data's current status, validity and whether it is enabled.

##### Data fields

Type	Field	Description
bool	featureEnabled	XTRA assistance data and NTP time download is enabled or disabled.
<a href="#">XtraDataStatus</a>	xtraDataStatus	XTRA assistance data status. If XTRA assistance data download is not enabled, this field will be set to XTRA_DATA_STATUS_UNKNOWN.
uint32_t	xtraValidFor↔ Hours	Number of hours that xtra assistance data will remain valid. This field will be valid when xtraDataStatus is set to XTRA_DATA_STATUS_VALID. For all other XtraDataStatus, this field will be set to 0.

#### 4.18.1.30 class telux::loc::ILocationInfoBase

[ILocationInfoBase](#) provides interface to get basic position related information like latitude, longitude, altitude, timestamp.

##### Public member functions

- virtual [LocationInfoValidity](#) [getLocationInfoValidity](#) ()=0
- virtual [LocationTechnology](#) [getTechMask](#) ()=0
- virtual float [getSpeed](#) ()=0

- virtual double `getLatitude ()=0`
- virtual double `getLongitude ()=0`
- virtual double `getAltitude ()=0`
- virtual float `getHeading ()=0`
- virtual float `getHorizontalUncertainty ()=0`
- virtual float `getVerticalUncertainty ()=0`
- virtual uint64\_t `getTimeStamp ()=0`
- virtual float `getSpeedUncertainty ()=0`
- virtual float `getHeadingUncertainty ()=0`
- virtual uint64\_t `getElapsedRealTime ()=0`
- virtual uint64\_t `getElapsedRealTimeUncertainty ()=0`

#### 4.18.1.30.1 Member Function Documentation

##### 4.18.1.30.1.1 virtual LocationInfoValidity telux::loc::ILocationInfoBase::getLocationInfoValidity ( ) [pure virtual]

Retrieves the validity of the Location basic Info.

#### Returns

Location basic validity mask.

##### 4.18.1.30.1.2 virtual LocationTechnology telux::loc::ILocationInfoBase::getTechMask ( ) [pure virtual]

Retrieves technology used in computing this fix.

#### Returns

Location technology mask.

##### 4.18.1.30.1.3 virtual float telux::loc::ILocationInfoBase::getSpeed ( ) [pure virtual]

Retrieves Speed.

#### Returns

speed in meters per second.

**4.18.1.30.1.4 virtual double telux::loc::ILocationInfoBase::getLatitude ( ) [pure virtual]**

Retrieves latitude. Positive and negative values indicate northern and southern latitude respectively

- Units: Degrees
- Range: -90.0 to 90.0

**Returns**

Latitude if available else returns NaN.

**4.18.1.30.1.5 virtual double telux::loc::ILocationInfoBase::getLongitude ( ) [pure virtual]**

Retrieves longitude. Positive and negative values indicate eastern and western longitude respectively

- Units: Degrees
- Range: -180.0 to 180.0

**Returns**

Longitude if available else returns NaN.

**4.18.1.30.1.6 virtual double telux::loc::ILocationInfoBase::getAltitude ( ) [pure virtual]**

Retrieves altitude above the WGS 84 reference ellipsoid.

- Units: Meters

**Returns**

Altitude if available else returns NaN.

**4.18.1.30.1.7 virtual float telux::loc::ILocationInfoBase::getHeading ( ) [pure virtual]**

Retrieves heading/bearing.

- Units: Degrees
- Range: 0 to 359.999

**Returns**

Heading if available else returns NaN.

**4.18.1.30.1.8 virtual float telux::loc::ILocationInfoBase::getHorizontalUncertainty ( ) [pure virtual]**

Retrieves the horizontal uncertainty.

- Units: Meters Uncertainty is defined with 68% confidence level.

**Returns**

Horizontal uncertainty.

**4.18.1.30.1.9 virtual float telux::loc::ILocationInfoBase::getVerticalUncertainty ( ) [pure virtual]**

Retrieves the vertical uncertainty.

- Units: Meters Uncertainty is defined with 68% confidence level.

**Returns**

Vertical uncertainty if available else returns NaN.

**4.18.1.30.1.10 virtual uint64\_t telux::loc::ILocationInfoBase::getTimeStamp ( ) [pure virtual]**

Retrieves UTC timeInfo for the location fix.

- Units: Milliseconds since Jan 1, 1970

**Returns**

TimeStamp in milliseconds if available else returns UNKNOWN\_TIMESTAMP which is zero(as UTC timeStamp has elapsed since January 1, 1970, it cannot be 0)

**4.18.1.30.1.11 virtual float telux::loc::ILocationInfoBase::getSpeedUncertainty ( ) [pure virtual]**

Retrieves 3-D speed uncertainty/accuracy.

- Units: Meters per Second Uncertainty is defined with 68% confidence level.

**Returns**

Speed uncertainty if available else returns NaN.

**4.18.1.30.1.12 virtual float telux::loc::ILocationInfoBase::getHeadingUncertainty ( ) [pure virtual]**

Retrieves heading uncertainty.

- Units: Degrees
- Range: 0 to 359.999 Uncertainty is defined with 68% confidence level.

**Returns**

Heading uncertainty if available else returns NaN.

#### 4.18.1.30.1.13 `virtual uint64_t telux::loc::ILocationInfoBase::getElapsedRealTime ( ) [pure virtual]`

Boot timestamp corresponding to the UTC timestamp for Location fix.

- Units: Nano-second

#### Returns

elapsed real time.

#### 4.18.1.30.1.14 `virtual uint64_t telux::loc::ILocationInfoBase::getElapsedRealTimeUncertainty ( ) [pure virtual]`

Retrieves elapsed real time uncertainty.

- Units: Nano-second

#### Returns

elapsed real time uncertainty.

### 4.18.1.31 `class telux::loc::ILocationInfoEx`

[ILocationInfoEx](#) provides interface to get richer position related information like latitude, longitude, altitude and other information like time stamp, session status, dop, reliabilities, uncertainties etc.

#### Public member functions

- virtual [LocationInfoExValidity](#) `getLocationInfoExValidity ()=0`
- virtual float `getAltitudeMeanSeaLevel ()=0`
- virtual float `getPositionDop ()=0`
- virtual float `getHorizontalDop ()=0`
- virtual float `getVerticalDop ()=0`
- virtual float `getGeometricDop ()=0`
- virtual float `getTimeDop ()=0`
- virtual float `getMagneticDeviation ()=0`
- virtual [LocationReliability](#) `getHorizontalReliability ()=0`
- virtual [LocationReliability](#) `getVerticalReliability ()=0`
- virtual float `getHorizontalUncertaintySemiMajor ()=0`
- virtual float `getHorizontalUncertaintySemiMinor ()=0`
- virtual float `getHorizontalUncertaintyAzimuth ()=0`
- virtual float `getEastStandardDeviation ()=0`



- virtual float `getNorthStandardDeviation ()=0`
- virtual `uint16_t` `getNumSvUsed ()=0`
- virtual `SvUsedInPosition` `getSvUsedInPosition ()=0`
- virtual void `getSVIds (std::vector< uint16_t > &idsOfUsedSVs)=0`
- virtual `SbasCorrection` `getSbasCorrection ()=0`
- virtual `GnssPositionTech` `getPositionTechnology ()=0`
- virtual `GnssKinematicsData` `getBodyFrameData ()=0`
- virtual `std::vector< GnssMeasurementInfo >` `getmeasUsageInfo ()=0`
- virtual `SystemTime` `getGnssSystemTime ()=0`
- virtual float `getTimeUncMs ()=0`
- virtual `telux::common::Status` `getLeapSeconds (uint8_t &leapSeconds)=0`
- virtual `telux::common::Status` `getVelocityEastNorthUp (std::vector< float > &velocityEastNorthUp)=0`
- virtual `telux::common::Status` `getVelocityUncertaintyEastNorthUp (std::vector< float > &velocityUncertaintyEastNorthUp)=0`
- virtual `uint8_t` `getCalibrationConfidencePercent ()=0`
- virtual `DrCalibrationStatus` `getCalibrationStatus ()=0`
- virtual `DrSolutionStatus` `getSolutionStatus ()=0`
- virtual `LocationAggregationType` `getLocOutputEngType ()=0`
- virtual `PositioningEngine` `getLocOutputEngMask ()=0`
- virtual float `getConformityIndex ()=0`
- virtual `LLAInfo` `getVRPBasedLLA ()=0`
- virtual `std::vector< float >` `getVRPBasedENUVelocity ()=0`
- virtual `AltitudeType` `getAltitudeType ()=0`
- virtual `ReportStatus` `getReportStatus ()=0`
- virtual `uint32_t` `getIntegrityRiskUsed ()=0`
- virtual float `getProtectionLevelAlongTrack ()=0`
- virtual float `getProtectionLevelCrossTrack ()=0`
- virtual float `getProtectionLevelVertical ()=0`

#### 4.18.1.31.1 Member Function Documentation

**4.18.1.31.1.1 virtual LocationInfoExValidity telux::loc::ILocationInfoEx::getLocationInfoExValidity ( ) [pure virtual]**

Retrieves the validity of the location info ex. It provides the validity of various information like dop, reliabilities, uncertainties etc.

**Returns**

Location ex validity mask

**4.18.1.31.1.2 virtual float telux::loc::ILocationInfoEx::getAltitudeMeanSeaLevel ( ) [pure virtual]**

Retrieves the altitude with respect to mean sea level.

- Units: Meters

**Returns**

Altitude with respect to mean sea level if available else returns NaN.

**4.18.1.31.1.3 virtual float telux::loc::ILocationInfoEx::getPositionDop ( ) [pure virtual]**

Retrieves position dilution of precision.

**Returns**

Position dilution of precision if available else returns NaN. Range: 1 (highest accuracy) to 50 (lowest accuracy)

**4.18.1.31.1.4 virtual float telux::loc::ILocationInfoEx::getHorizontalDop ( ) [pure virtual]**

Retrieves horizontal dilution of precision.

**Returns**

Horizontal dilution of precision if available else returns NaN. Range: 1 (highest accuracy) to 50 (lowest accuracy)

**4.18.1.31.1.5 virtual float telux::loc::ILocationInfoEx::getVerticalDop ( ) [pure virtual]**

Retrieves vertical dilution of precision.

**Returns**

Vertical dilution of precision if available else returns NaN Range: 1 (highest accuracy) to 50 (lowest accuracy)

**4.18.1.31.1.6 virtual float telux::loc::ILocationInfoEx::getGeometricDop ( ) [pure virtual]**

Retrieves geometric dilution of precision.

**Returns**

geometric dilution of precision.

**4.18.1.31.1.7 virtual float telux::loc::ILocationInfoEx::getTimeDop ( ) [pure virtual]**

Retrieves time dilution of precision.

**Returns**

Time dilution of precision.

**4.18.1.31.1.8 virtual float telux::loc::ILocationInfoEx::getMagneticDeviation ( ) [pure virtual]**

Retrieves the difference between the bearing to true north and the bearing shown on magnetic compass. The deviation is positive when the magnetic north is east of true north.

- Units: Degrees

**Returns**

Magnetic Deviation if available else returns NaN

**4.18.1.31.1.9 virtual LocationReliability telux::loc::ILocationInfoEx::getHorizontalReliability ( ) [pure virtual]**

Specifies the reliability of the horizontal position.

**Returns**

[LocationReliability](#) of the horizontal position if available else returns UNKNOWN.

**4.18.1.31.1.10 virtual LocationReliability telux::loc::ILocationInfoEx::getVerticalReliability ( ) [pure virtual]**

Specifies the reliability of the vertical position.

**Returns**

[LocationReliability](#) of the vertical position if available else returns UNKNOWN.

**4.18.1.31.1.11 virtual float telux::loc::ILocationInfoEx::getHorizontalUncertaintySemiMajor ( ) [pure virtual]**

Retrieves semi-major axis of horizontal elliptical uncertainty.

- Units: Meters Uncertainty is defined with 39% confidence level.

**Returns**

Semi-major horizontal elliptical uncertainty if available else returns NaN.

**4.18.1.31.1.12 virtual float telux::loc::ILocationInfoEx::getHorizontalUncertaintySemiMinor ( ) [pure virtual]**

Retrieves semi-minor axis of horizontal elliptical uncertainty.

- Units: Meters Uncertainty is defined with 39% confidence level.

**Returns**

Semi-minor horizontal elliptical uncertainty if available else returns NaN.

**4.18.1.31.1.13 virtual float telux::loc::ILocationInfoEx::getHorizontalUncertaintyAzimuth ( ) [pure virtual]**

Retrieves elliptical horizontal uncertainty azimuth of orientation.

- Units: Decimal degrees
- Range: 0 to 180 Confidence for uncertainty is not specified.

**Returns**

Elliptical horizontal uncertainty azimuth of orientation if available else returns NaN.

**4.18.1.31.1.14 virtual float telux::loc::ILocationInfoEx::getEastStandardDeviation ( ) [pure virtual]**

Retrieves east standard deviation.

- Units: Meters Uncertainty is defined with 68% confidence level.

**Returns**

East Standard Deviation.

**4.18.1.31.1.15 virtual float telux::loc::ILocationInfoEx::getNorthStandardDeviation ( ) [pure virtual]**

Retrieves north standard deviation.

- Units: Meters Uncertainty is defined with 68% confidence level.

### Returns

North Standard Deviation.

**4.18.1.31.1.16** `virtual uint16_t telux::loc::ILocationInfoEx::getNumSvUsed ( ) [pure virtual]`

Retrieves number of satellite vehicles used in position report.

### Returns

number of Sv used.

**4.18.1.31.1.17** `virtual SvUsedInPosition telux::loc::ILocationInfoEx::getSvUsedInPosition ( ) [pure virtual]`

Retrives the set of satellite vehicles that are used to calculate position.

### Returns

set of satellite vehicles for different constellations.

**4.18.1.31.1.18** `virtual void telux::loc::ILocationInfoEx::getSVIds ( std::vector< uint16_t > & idsOfUsedSVs ) [pure virtual]`

Retrieves GNSS Satellite Vehicles used in position data.

### Parameters

out	<i>idsOfUsedSVs</i>	Vector of Satellite Vehicle identifiers.
-----	---------------------	--

**4.18.1.31.1.19** `virtual SbasCorrection telux::loc::ILocationInfoEx::getSbasCorrection ( ) [pure virtual]`

Retrieves navigation solution mask used to indicate SBAS corrections.

### Returns

- SBAS (Satellite Based Augmentation System) Correction mask used.

**4.18.1.31.1.20 virtual GnssPositionTech telux::loc::ILocationInfoEx::getPositionTechnology ( )**  
**[pure virtual]**

Retrieves position technology mask used to indicate which technology is used.

**Returns**

- Position technology used in computing this fix.

**4.18.1.31.1.21 virtual GnssKinematicsData telux::loc::ILocationInfoEx::getBodyFrameData ( )** **[pure virtual]**

Retrieves position related information.

**4.18.1.31.1.22 virtual std::vector<GnssMeasurementInfo> telux::loc::ILocationInfoEx::getmeas↔**  
**UsageInfo ( ) [pure virtual]**

Retrieves gnss measurement usage info.

**4.18.1.31.1.23 virtual SystemTime telux::loc::ILocationInfoEx::getGnssSystemTime ( )** **[pure virtual]**

Retrieves type of gnss system.

**Returns**

- Type of Gnss System.

**4.18.1.31.1.24 virtual float telux::loc::ILocationInfoEx::getTimeUncMs ( )** **[pure virtual]**

Retrieves time uncertainty. For PVT report from SPE engine, confidence level is at 99%. For PVT reports from other engines, confidence level is undefined.

**Returns**

- Time uncertainty in milliseconds.

**4.18.1.31.1.25 virtual telux::common::Status telux::loc::ILocationInfoEx::getLeapSeconds ( uint8\_t &**  
**leapSeconds ) [pure virtual]**

Retrieves leap seconds if available.

**Parameters**

out	<i>leapSeconds</i>	- leap seconds • Units: Seconds
-----	--------------------	------------------------------------

**Returns**

Status of leap seconds.

**4.18.1.31.1.26** `virtual telux::common::Status telux::loc::ILocationInfoEx::getVelocityEastNorthUp ( std::vector< float > & velocityEastNorthUp ) [pure virtual]`

Retrieves east, North, Up velocity if available.

**Parameters**

out	<i>velocityEastNorthUp</i>	- east, North, Up velocity • Units: Meters/second
-----	----------------------------	--

**Returns**

Status of availability of east, North, Up velocity.

**4.18.1.31.1.27** `virtual telux::common::Status telux::loc::ILocationInfoEx::getVelocityUncertainty↔ EastNorthUp ( std::vector< float > & velocityUncertaintyEastNorthUp ) [pure virtual]`

Retrieves east, North, Up velocity uncertainty if available. Uncertainty is defined with 68% confidence level.

**Parameters**

out	<i>velocity↔ UncertaintyEast↔ NorthUp</i>	- east, North, Up velocity uncertainty • Units: Meters/second
-----	---	--

**Returns**

Status of availability of east, North, Up velocity uncertainty.

**4.18.1.31.1.28** `virtual uint8_t telux::loc::ILocationInfoEx::getCalibrationConfidencePercent ( ) [pure virtual]`

Sensor calibration confidence percent, range [0, 100].

**Returns**

the percentage of calibration taking all the parameters into account.

**4.18.1.31.1.29 virtual DrCalibrationStatus telux::loc::ILocationInfoEx::getCalibrationStatus ( ) [pure virtual]**

Sensor calibration status.

#### Returns

mask indicating the calibration status with respect to different parameters.

**4.18.1.31.1.30 virtual DrSolutionStatus telux::loc::ILocationInfoEx::getSolutionStatus ( ) [pure virtual]**

DR solution status.

#### Returns

mask indicating the solution status with respect to the DR position engine.

**4.18.1.31.1.31 virtual LocationAggregationType telux::loc::ILocationInfoEx::getLocOutputEngType ( ) [pure virtual]**

Location engine type. When the type is set to LOC\_ENGINE\_SRC\_FUSED, the fix is the propagated/aggregated reports from all engines running on the system (e.g.: DR/SPE/PPE) based QTI algorithm. To check which location engine contributes to the fused output, check for locOutputEngMask.

#### Returns

the type of engine that was used for calculating the position fix.

**4.18.1.31.1.32 virtual PositioningEngine telux::loc::ILocationInfoEx::getLocOutputEngMask ( ) [pure virtual]**

When loc output eng type is set to fused, this field indicates the set of engines contribute to the fix.

#### Returns

the combination of position engines used in calculating the position report when the loc output end type is set to fused.

**4.18.1.31.1.33 virtual float telux::loc::ILocationInfoEx::getConformityIndex ( ) [pure virtual]**

When robust location is enabled, this field will indicate how well the various input data considered for navigation solution conforms to expectations.

#### Returns

values in the range [0.0, 1.0], with 0.0 for least conforming and 1.0 for most conforming.



**4.18.1.31.1.34** virtual LLAInfo telux::loc::ILocationInfoEx::getVRPBasedLLA ( ) [pure virtual]

Vehicle Reference Point(VRP) based latitude, longitude and altitude information.

**4.18.1.31.1.35** virtual std::vector<float> telux::loc::ILocationInfoEx::getVRPBasedENUVelocity ( ) [pure virtual]

VRP-based east, north and up velocity information.

#### Returns

- vector of directional velocities in this order {east velocity, north velocity, up velocity}

**4.18.1.31.1.36** virtual AltitudeType telux::loc::ILocationInfoEx::getAltitudeType ( ) [pure virtual]

Determination of altitude is assumed or calculated. ASSUMED means there may not be enough satellites to determine the precise altitude.

#### Returns

altitude type ASSUMED/CALCULATED or if not available then UNKNOWN.

**4.18.1.31.1.37** virtual ReportStatus telux::loc::ILocationInfoEx::getReportStatus ( ) [pure virtual]

Indicates the status of this report in terms of how optimally the report was calculated by the engine.

#### Returns

Status of the report. Returns [ReportStatus::UNKNOWN](#) if status is unavailable.

**4.18.1.31.1.38** virtual uint32\_t telux::loc::ILocationInfoEx::getIntegrityRiskUsed ( ) [pure virtual]

Integrity risk used for protection level parameters. Unit of 2.5e-10. Valid range is [1 to (4e9-1)]. Values other than valid range means integrity risk is disabled and [ILocationInfoEx::getProtectionLevelAlongTrack](#), [ILocationInfoEx::getProtectionLevelCrossTrack](#) and [ILocationInfoEx::getProtectionLevelVertical](#) will not be available.

**4.18.1.31.1.39** virtual float telux::loc::ILocationInfoEx::getProtectionLevelAlongTrack ( ) [pure virtual]

Along-track protection level at specified integrity risk, in unit of meter.

**4.18.1.31.1.40** virtual float telux::loc::ILocationInfoEx::getProtectionLevelCrossTrack ( ) [pure virtual]

Cross-track protection level at specified integrity risk, in unit of meter.

#### 4.18.1.31.1.41 virtual float telux::loc::!LocationInfoEx::getProtectionLevelVertical ( ) [pure virtual]

Vertical component protection level at specified integrity risk, in unit of meter.

#### 4.18.1.32 class telux::loc::!SVInfo

[ISVInfo](#) provides interface to retrieve information about Satellite Vehicles, their position and health status.

##### Public member functions

- virtual [GnssConstellationType](#) getConstellation ()=0
- virtual uint16\_t getId ()=0
- virtual [SVHealthStatus](#) getSVHealthStatus ()=0
- virtual [SVStatus](#) getStatus ()=0
- virtual [SVInfoAvailability](#) getHasEphemeris ()=0
- virtual [SVInfoAvailability](#) getHasAlmanac ()=0
- virtual [SVInfoAvailability](#) getHasFix ()=0
- virtual float getElevation ()=0
- virtual float getAzimuth ()=0
- virtual float getSnr ()=0
- virtual float getCarrierFrequency ()=0
- virtual [GnssSignal](#) getSignalType ()=0
- virtual uint16\_t getGlonassFcn ()=0
- virtual double getBasebandCnr ()=0

#### 4.18.1.32.1 Member Function Documentation

##### 4.18.1.32.1.1 virtual GnssConstellationType telux::loc::!SVInfo::getConstellation ( ) [pure virtual]

Indicates to which constellation this satellite vehicle belongs.

##### Returns

[GnssConstellationType](#) if available else returns UNKNOWN.

**4.18.1.32.1.2 virtual uint16\_t telux::loc::ISVInfo::getId ( ) [pure virtual]**

GNSS satellite vehicle ID. SV id range of each supported constellations mentioned in [GnssMeasurementInfo](#).

**Returns**

Identifier of the satellite vehicle otherwise 0(as 0 is not an ID for any of the SVs)

**4.18.1.32.1.3 virtual SVHealthStatus telux::loc::ISVInfo::getSVHealthStatus ( ) [pure virtual]**

Health status of satellite vehicle.

**Returns**

HealthStatus of Satellite Vehicle if available else returns UNKNOWN.

- [SVHealthStatus](#)

**Deprecated**

This API is not supported.

**4.18.1.32.1.4 virtual SVStatus telux::loc::ISVInfo::getStatus ( ) [pure virtual]**

Status of satellite vehicle.

**Note**

This API is work-in-progress and is subject to change.

**Returns**

Satellite Vehicle Status if available else returns UNKNOWN.

- [SVStatus](#)

**Deprecated**

This API is not supported.

**4.18.1.32.1.5 virtual SVInfoAvailability telux::loc::ISVInfo::getHasEphemeris ( ) [pure virtual]**

Indicates whether ephemeris information(which allows the receiver to calculate the satellite's position) is available.

**Returns**

[SVInfoAvailability](#) if Ephemeris exists or not else returns UNKNOWN.

**4.18.1.32.1.6 virtual SVInfoAvailability telux::loc::ISVInfo::getHasAlmanac ( ) [pure virtual]**

Indicates whether almanac information(which allows receivers to know which satellites are available for tracking) is available.

**Returns**

[SVInfoAvailability](#) if almanac exists or not else returns UNKNOWN.

**4.18.1.32.1.7 virtual SVInfoAvailability telux::loc::ISVInfo::getHasFix ( ) [pure virtual]**

Indicates whether the satellite is used in computing the fix.

**Returns**

[SVInfoAvailability](#), if satellite used or not else returns UNKNOWN.

**4.18.1.32.1.8 virtual float telux::loc::ISVInfo::getElevation ( ) [pure virtual]**

Retrieves satellite vehicle elevation angle.

- Units: Degrees
- Range: 0 to 90

**Returns**

Elevation if available else returns NaN.

**4.18.1.32.1.9 virtual float telux::loc::ISVInfo::getAzimuth ( ) [pure virtual]**

Retrieves satellite vehicle azimuth angle.

- Units: Degrees
- Range: 0 to 360

**Returns**

Azimuth if available else returns NaN.

**4.18.1.32.1.10 virtual float telux::loc::ISVInfo::getSnr ( ) [pure virtual]**

Retrieves signal-to-noise ratio of the signal measured at antenna of the satellite vehicle.

- Units: dB-Hz

**Returns**

SNR if available else returns 0.0 value.

**4.18.1.32.1.11 virtual float telux::loc::ISVInfo::getCarrierFrequency ( ) [pure virtual]**

Indicates the carrier frequency of the signal tracked.

**Returns**

carrier frequency in Hz else returns UNKNOWN\_CARRIER\_FREQ frequency when not supported.

**4.18.1.32.1.12 virtual GnssSignal telux::loc::ISVInfo::getSignalType ( ) [pure virtual]**

Indicates the validity for different types of signal for gps, galileo, beidou etc.

**Returns**

signalType mask else return UNKNOWN\_SIGNAL\_MASK when not supported.

**4.18.1.32.1.13 virtual uint16\_t telux::loc::ISVInfo::getGlonassFcn ( ) [pure virtual]**

Retrieves GLONASS frequency channel number in the range [1, 14] which is calculated as FCN [-7, 6] + 8.

**Returns**

GLONASS frequency channel number.

**4.18.1.32.1.14 virtual double telux::loc::ISVInfo::getBasebandCnr ( ) [pure virtual]**

Carrier-to-noise ratio of the signal measured at baseband.

- Units: dB-Hz

**Returns**

carrier-to-noise ratio at baseband else returns UNKNOWN\_BASEBAND\_CARRIER\_NOISE ratio when not supported.

**4.18.1.33 class telux::loc::IGnssSVInfo**

[IGnssSVInfo](#) provides interface to retrieve the list of SV info available and whether altitude is assumed or calculated.

**Public member functions**

- virtual [AltitudeType](#) [getAltitudeType](#) ()=0
- virtual std::vector< std::shared\_ptr< [ISVInfo](#) > > [getSVInfoList](#) ()=0

#### 4.18.1.33.1 Member Function Documentation

##### 4.18.1.33.1.1 virtual AltitudeType telux::loc::IGnssSVInfo::getAltitudeType ( ) [pure virtual]

Indicates whether altitude is assumed or calculated.

#### Returns

[AltitudeType](#) if available else returns UNKNOWN.

#### Deprecated

This API is not supported.

##### 4.18.1.33.1.2 virtual std::vector<std::shared\_ptr<ISVInfo> > telux::loc::IGnssSVInfo::getSVInfoList ( ) [pure virtual]

Pointer to satellite vehicles information for all GNSS constellations except GPS.

#### Returns

Vector of pointer of [ISVInfo](#) object if available else returns empty vector.

#### 4.18.1.34 class telux::loc::IGnssSignalInfo

[IGnssSignalInfo](#) provides interface to retrieve GNSS data information like jammer metrics and automatic gain control for satellite signal type.

#### Public member functions

- virtual [GnssData](#) getGnssData ()=0

#### 4.18.1.34.1 Member Function Documentation

##### 4.18.1.34.1.1 virtual GnssData telux::loc::IGnssSignalInfo::getGnssData ( ) [pure virtual]

Retrieves jammer metric and Automatic Gain Control(AGC) corresponding to signal types. Jammer metric is linearly proportional to the sum of jammer and noise power at the GNSS antenna port.

#### Returns

List of jammer metric and a list of automatic gain control for signal type.

#### 4.18.1.35 class telux::loc::LocationFactory

[LocationFactory](#) allows creation of location manager.

**Public member functions**

- virtual std::shared\_ptr< [ILocationManager](#) > [getLocationManager](#) (telux::common::InitResponseCb callback=nullptr)=0
- virtual std::shared\_ptr< [ILocationConfigurator](#) > [getLocationConfigurator](#) (telux::common::InitResponseCb callback=nullptr)=0
- virtual std::shared\_ptr< [IDgnssManager](#) > [getDgnssManager](#) (DgnssDataFormat dataFormat=[DgnssDataFormat::DATA\\_FORMAT\\_RTCM\\_3](#), telux::common::InitResponseCb callback=nullptr)=0

**Static Public Member Functions**

- static [LocationFactory](#) & [getInstance](#) ()

**4.18.1.35.1 Member Function Documentation****4.18.1.35.1.1 static [LocationFactory](#)& telux::loc::LocationFactory::getInstance ( ) [static]**

Get Location Factory instance.

**4.18.1.35.1.2 virtual std::shared\_ptr<[ILocationManager](#)> telux::loc::LocationFactory::get↔  
[LocationManager](#) ( telux::common::InitResponseCb *callback = nullptr* ) [pure  
virtual]**

Get instance of Location Manager

**Parameters**

in	<i>callback</i>	Optional callback to get the response of the manager initialization.
----	-----------------	--

**Returns**

Pointer of [ILocationManager](#) object.

**4.18.1.35.1.3 virtual std::shared\_ptr<[ILocationConfigurator](#)> telux::loc::LocationFactory::get↔  
[LocationConfigurator](#) ( telux::common::InitResponseCb *callback = nullptr* ) [pure  
virtual]**

Get instance of Location Configurator.

**Parameters**

in	<i>callback</i>	Optional callback pointer to get the response of the manager initialisation.
----	-----------------	--

**Returns**

Pointer of [ILocationConfigurator](#) object.

**4.18.1.35.1.4** `virtual std::shared_ptr<IDgnssManager> telux::loc::LocationFactory::getDgnssManager ( DgnssDataFormat dataFormat = DgnssDataFormat::DATA_FORMAT_RTCM_3, telux::common::InitResponseCb callback = nullptr ) [pure virtual]`

Get instance of Dgnss manager.

**Parameters**

in	<i>dataFormat</i>	<a href="#">DgnssDataFormat</a> RTCM injection data format
in	<i>callback</i>	Optional callback pointer to get the response of the manager initialisation.

**Returns**

Pointer of [IDgnssManager](#) object.

**4.18.1.36 class telux::loc::ILocationListener**

Listener class for getting location updates and satellite vehicle information.

The methods in listener can be invoked from multiple different threads. Client needs to make sure that implementation is thread-safe.

**Public member functions**

- virtual void [onBasicLocationUpdate](#) (const std::shared\_ptr< [ILocationInfoBase](#) > &locationInfo)
- virtual void [onDetailedLocationUpdate](#) (const std::shared\_ptr< [ILocationInfoEx](#) > &locationInfo)
- virtual void [onDetailedEngineLocationUpdate](#) (const std::vector< std::shared\_ptr< [ILocationInfoEx](#) > > &locationEngineInfo)
- virtual void [onGnssSVInfo](#) (const std::shared\_ptr< [IGnssSVInfo](#) > &gnssSVInfo)
- virtual void [onGnssSignalInfo](#) (const std::shared\_ptr< [IGnssSignalInfo](#) > &info)
- virtual void [onGnssNmeaInfo](#) (uint64\_t timestamp, const std::string &nmea)
- virtual void [onEngineNmeaInfo](#) ([LocationAggregationType](#) engineType, uint64\_t timestamp, const std::string &nmea)
- virtual void [onGnssMeasurementsInfo](#) (const [telux::loc::GnssMeasurements](#) &measurementInfo)
- virtual void [onGnssDisasterCrisisInfo](#) (const [telux::loc::GnssDisasterCrisisReport](#) &dcReportInfo)
- virtual void [onCapabilitiesInfo](#) (const [telux::loc::LocCapability](#) capabilityInfo)
- virtual [~ILocationListener](#) ()



### 4.18.1.36.1 Constructors and Destructors

#### 4.18.1.36.1.1 virtual telux::loc::ILocationListener::~~ILocationListener ( ) [virtual]

Destructor of [ILocationListener](#)

### 4.18.1.36.2 Member Function Documentation

#### 4.18.1.36.2.1 virtual void telux::loc::ILocationListener::onBasicLocationUpdate ( const std::shared\_ptr< ILocationInfoBase > & locationInfo ) [virtual]

This function is called when device receives location update. When there are multiple engines running on the system, the received location information is fused report from all engines.

On platforms with Access control enabled, the client needs to have TELUX\_LOC\_DATA permission for this listener API to be invoked.

#### Parameters

in	<i>locationInfo</i>	- Location information like latitude, longitude, timeInfo other information such as heading, altitude and velocity etc.
----	---------------------	---

#### 4.18.1.36.2.2 virtual void telux::loc::ILocationListener::onDetailedLocationUpdate ( const std::shared\_ptr< ILocationInfoEx > & locationInfo ) [virtual]

This function is called when device receives Gns location update. When there are multiple engines running on the system, the received location information is fused report from all engines.

On platforms with Access control enabled, the client needs to have TELUX\_LOC\_DATA permission for this listener API to be invoked.

#### Parameters

in	<i>locationInfo</i>	- Contains richer set of location information like latitude, longitude, timeInfo, heading, altitude, velocity and other information such as deviations, elliptical accuracies etc.
----	---------------------	--

#### 4.18.1.36.2.3 virtual void telux::loc::ILocationListener::onDetailedEngineLocationUpdate ( const std::vector< std::shared\_ptr< ILocationInfoEx > > & locationEngineInfo ) [virtual]

This function is called when device receives multiple Gns location update from the different engine types requested, which are SPE/PPE/FUSED. This API will be called ONLY if we use startDetailedEngineReports.

On platforms with Access control enabled, the client needs to have TELUX\_LOC\_DATA permission for this listener API to be invoked.

**Parameters**

in	<i>locationEngineInfo</i>	- Contains a list of location infos. Each element in the list corresponds to one of SPE/PPE/FUSED.
----	---------------------------	--

#### 4.18.1.36.2.4 virtual void telux::loc::ILocationListener::onGnssSVInfo ( const std::shared\_ptr< IGnssSVInfo > & gnssSVInfo ) [virtual]

This function is called when device receives GNSS satellite information.

On platforms with Access control enabled, the client needs to have TELUX\_LOC\_DATA permission for this listener API to be invoked.

**Parameters**

in	<i>gnssSVInfo</i>	- GNSS satellite information
----	-------------------	------------------------------

#### 4.18.1.36.2.5 virtual void telux::loc::ILocationListener::onGnssSignalInfo ( const std::shared\_ptr< IGnssSignalInfo > & info ) [virtual]

This function is called when device receives GNSS data information like jammer metrics and automatic gain control for satellite signal type.

On platforms with Access control enabled, the client needs to have TELUX\_LOC\_DATA permission for this listener API to be invoked.

**Parameters**

in	<i>info</i>	- GNSS signal info
----	-------------	--------------------

#### 4.18.1.36.2.6 virtual void telux::loc::ILocationListener::onGnssNmeaInfo ( uint64\_t timestamp, const std::string & nmea ) [virtual]

This function is called when device receives GNSS NMEA sentences from FUSED engine.

To receive these updates, clients need to set the `telux::loc::GnssReportType::NMEA` bit in the `reportMask` passed as a paramter to [ILocationManager::startDetailedReports](#) or [ILocationManager::startDetailedEngineReports](#).

Also refer to [ILocationManager::startDetailedEngineReports](#) to understand the usage further.

On platforms with Access control enabled, the client needs to have TELUX\_LOC\_DATA permission for this listener API to be invoked.

**Parameters**

in	<i>timestamp</i>	- Timestamp
in	<i>nmea</i>	- Nmea sentence

#### 4.18.1.36.2.7 **virtual void telux::loc::ILocationListener::onEngineNmeaInfo ( LocationAggregationType engineType, uint64\_t timestamp, const std::string & nmea ) [virtual]**

This function is called when device receives NMEA sentences from a specific engine.

To receive these updates, clients need to set the `telux::loc::GnssReportType::ENGINE_NMEA` bit in the `reportMask` passed as a paramter to [ILocationManager::startDetailedEngineReports](#).

Also refer to [ILocationManager::startDetailedEngineReports](#) to understand the usage further.

On platforms with Access control enabled, the client needs to have `TELUX_LOC_DATA` permission for this listener API to be invoked.

##### Parameters

in	<i>engineType</i>	- Engine Type used in generating the NMEA sentence.
in	<i>timestamp</i>	- Timestamp
in	<i>nmea</i>	- Nmea sentence

#### 4.18.1.36.2.8 **virtual void telux::loc::ILocationListener::onGnssMeasurementsInfo ( const telux::loc::GnssMeasurements & measurementInfo ) [virtual]**

This function is called when device receives signal measurement information such as satellite vehicle pseudo range, satellite vehicle clock time, carrier phase measurement etc. The frequency at which this API is called is determined by what was requested `telux::loc::GnssReportType::MEASUREMENT` or `telux::loc::GnssReportType::HIGH_RATE_MEASUREMENT` in [ILocationManager::startDetailedReports](#) and [ILocationManager::startDetailedEngineReports](#).

On platforms with Access control enabled, the client needs to have `TELUX_LOC_DATA` permission for this listener API to be invoked.

##### Parameters

in	<i>measurementInfo</i>	- GNSS measurement information
----	------------------------	--------------------------------

#### 4.18.1.36.2.9 **virtual void telux::loc::ILocationListener::onGnssDisasterCrisisInfo ( const telux::loc::GnssDisasterCrisisReport & dcReportInfo ) [virtual]**

This function is called during a disaster/crisis to update the disaster/crisis reports.

##### Parameters

in	<i>dcReportInfo</i>	- GNSS disaster/crisis report information. This includes the report type and data payload received from the GNSS engine.
----	---------------------	--

#### 4.18.1.36.2.10 virtual void telux::loc::ILocationListener::onCapabilitiesInfo ( const telux::loc::Loc↔ Capability *capabilityInfo* ) [virtual]

This function is called when the capabilities of the location stack gets updated.

On platforms with Access control enabled, the client needs to have TELUX\_LOC\_DATA permission for this listener API to be invoked.

##### Parameters

in	<i>capabilityInfo</i>	- <a href="#">telux::loc::LocCapability</a> , capability information
----	-----------------------	--

#### 4.18.1.37 class telux::loc::ILocationSystemInfoListener

##### Public member functions

- virtual void [onLocationSystemInfo](#) (const [LocationSystemInfo](#) &locationSystemInfo)
- virtual [~ILocationSystemInfoListener](#) ()

##### 4.18.1.37.1 Constructors and Destructors

#### 4.18.1.37.1.1 virtual telux::loc::ILocationSystemInfoListener::~~ILocationSystemInfoListener ( ) [virtual]

Destructor of [ILocationSystemInfoListener](#)

##### 4.18.1.37.2 Member Function Documentation

#### 4.18.1.37.2.1 virtual void telux::loc::ILocationSystemInfoListener::onLocationSystemInfo ( const [LocationSystemInfo](#) & *locationSystemInfo* ) [virtual]

This function is called when device receives location related system information such as leap second change.

On platforms with Access control enabled, the client needs to have TELUX\_LOC\_DATA permission for this listener API to be invoked.

##### Parameters

in	<i>locationSystemInfo</i>	- contains location system information such as current leap seconds change
----	---------------------------	--

### 4.18.1.38 class telux::loc::ILocationConfigListener

[ILocationConfigListener](#) interface is used to receive notifications related to configuration events.

Clients can register for updates via [ILocationConfigurator::registerListener](#) by passing the list of indications present under [telux::loc::LocConfigIndicationsType](#).

The listener method can be invoked from multiple different threads. Client needs to make sure that implementation is thread-safe.

#### Public member functions

- virtual void [onXtraStatusUpdate](#) (const [XtraStatus](#) xtraStatus)
- virtual void [onGnssSignalUpdate](#) (const [GnssSignal](#) gnssSignalMask)
- virtual [~ILocationConfigListener](#) ()

#### 4.18.1.38.1 Constructors and Destructors

4.18.1.38.1.1 virtual [telux::loc::ILocationConfigListener::~~ILocationConfigListener](#) ( ) [virtual]

#### 4.18.1.38.2 Member Function Documentation

4.18.1.38.2.1 virtual void [telux::loc::ILocationConfigListener::onXtraStatusUpdate](#) ( const [XtraStatus](#) *xtraStatus* ) [virtual]

The API is invoked when there is any update in the Xtra assistance data.

Clients need to register for this indication via [LocConfigIndicationsType::LOC\\_CONF\\_IND\\_XTRA\\_STATUS](#).

#### Parameters

in	<i>xtraStatus</i>	- Xtra assistant data's current status, validity and whether it is enabled.
----	-------------------	---

4.18.1.38.2.2 virtual void [telux::loc::ILocationConfigListener::onGnssSignalUpdate](#) ( const [GnssSignal](#) *gnssSignalMask* ) [virtual]

The API is invoked when there is any update in the Gnss Signal types supported by the modem.

When [ILocationConfigurator::configureSecondaryBand](#) is invoked, the supported signals would be updated and notified via this listener API.

Clients need to register for this indication via [LocConfigIndicationsType::LOC\\_CONF\\_IND\\_SIGNAL\\_UPDATE](#).

#### Parameters

in	<i>gnssSignalMask</i>	- Bitset to represent the Gnss signal types supported by the modem.
----	-----------------------	---

### 4.18.1.39 class telux::loc::ILocationManager

[ILocationManager](#) provides interface to register and remove listeners. It also allows to set and get configuration/ criteria for position reports. The new APIs([registerListenerEx](#), [deRegisterListenerEx](#), [startDetailedReports](#), [startBasicReports](#)) and old/deprecated APIs([registerListener](#), [removeListener](#), [setPositionReportTimeout](#), [setHorizontalAccuracyLevel](#), [setMinIntervalForReports](#)) should not be used interchangeably, either the new APIs should be used or the old APIs should be used.

#### Public Types

- using [GetEnergyConsumedCallback](#) = std::function< void([telux::loc::GnssEnergyConsumedInfo](#) energyConsumed, [telux::common::ErrorCode](#) error)>
- using [GetYearOfHwCallback](#) = std::function< void(uint16\_t yearOfHw, [telux::common::ErrorCode](#) error)>
- using [GetTerrestrialInfoCallback](#) = std::function< void(const std::shared\_ptr< [ILocationInfoBase](#) > terrestrialInfo)>

#### Public member functions

- virtual bool [isSubsystemReady](#) ()=0
- virtual [telux::common::ServiceStatus](#) [getServiceStatus](#) ()=0
- virtual std::future< bool > [onSubsystemReady](#) ()=0
- virtual [telux::common::Status](#) [registerListenerEx](#) (std::weak\_ptr< [ILocationListener](#) > listener)=0
- virtual [telux::common::Status](#) [deRegisterListenerEx](#) (std::weak\_ptr< [ILocationListener](#) > listener)=0
- virtual [telux::common::Status](#) [startDetailedReports](#) (uint32\_t interval, [telux::common::ResponseCallback](#) callback=nullptr, [GnssReportTypeMask](#) reportMask=DEFAULT\_GNSS\_REPORT)=0
- virtual [telux::common::Status](#) [startDetailedEngineReports](#) (uint32\_t interval, [LocReqEngine](#) engineType, [telux::common::ResponseCallback](#) callback=nullptr, [GnssReportTypeMask](#) reportMask=DEFAULT\_GNSS\_REPORT)=0
- virtual [telux::common::Status](#) [startBasicReports](#) (uint32\_t distanceInMeters, uint32\_t intervalInMs, [telux::common::ResponseCallback](#) callback=nullptr)=0
- virtual [telux::common::Status](#) [registerForSystemInfoUpdates](#) (std::weak\_ptr< [ILocationSystemInfoListener](#) > listener, [telux::common::ResponseCallback](#) callback=nullptr)=0
- virtual [telux::common::Status](#) [deRegisterForSystemInfoUpdates](#) (std::weak\_ptr< [ILocationSystemInfoListener](#) > listener, [telux::common::ResponseCallback](#) callback=nullptr)=0
- virtual [telux::common::Status](#) [requestEnergyConsumedInfo](#) ([GetEnergyConsumedCallback](#) cb)=0
- virtual [telux::common::Status](#) [stopReports](#) ([telux::common::ResponseCallback](#) callback=nullptr)=0
- virtual [telux::common::Status](#) [getYearOfHw](#) ([GetYearOfHwCallback](#) cb)=0
- virtual [telux::common::Status](#) [getTerrestrialPosition](#) (uint32\_t timeoutMsec, [TerrestrialTechnology](#) techMask, [GetTerrestrialInfoCallback](#) cb, [telux::common::ResponseCallback](#) callback=nullptr)=0
- virtual [telux::common::Status](#) [cancelTerrestrialPositionRequest](#) ([telux::common::ResponseCallback](#)

callback=nullptr)=0

- virtual [telux::loc::LocCapability](#) getCapabilities ()=0
- virtual [~ILocationManager](#) ()

#### 4.18.1.39.1 Member Typedef Documentation

**4.18.1.39.1.1** using [telux::loc::ILocationManager::GetEnergyConsumedCallback](#) = std::function<void([telux::loc::GnssEnergyConsumedInfo](#) energyConsumed, [telux::common::ErrorCode](#) error)>

This function is called with the response to getEnergyConsumedInfoUpdate API.

##### Parameters

in	<i>energyConsumed</i>	- Information regarding energy consumed by Gnss engine.
in	<i>error</i>	- Return code which indicates whether the operation succeeded or not.

**4.18.1.39.1.2** using [telux::loc::ILocationManager::GetYearOfHwCallback](#) = std::function<void(uint16\_t yearOfHw, [telux::common::ErrorCode](#) error)>

This function is called with the response to getYearOfHw API.

##### Parameters

in	<i>yearOfHw</i>	- Year of hardware information.
in	<i>error</i>	- Return code which indicates whether the operation succeeded or not.

**4.18.1.39.1.3** using [telux::loc::ILocationManager::GetTerrestrialInfoCallback](#) = std::function<void(const std::shared\_ptr<[ILocationInfoBase](#)> terrestrialInfo)>

This function is called with the response to getTerrestrialPosition API.

##### Parameters

in	<i>terrestrialInfo</i>	- basic position related information.
----	------------------------	---------------------------------------

#### 4.18.1.39.2 Constructors and Destructors

**4.18.1.39.2.1** virtual [telux::loc::ILocationManager::~ILocationManager](#) ( ) [virtual]

Destructor of [ILocationManager](#)

### 4.18.1.39.3 Member Function Documentation

#### 4.18.1.39.3.1 `virtual bool telux::loc::ILocationManager::isSubsystemReady ( ) [pure virtual]`

Checks the status of location subsystems and returns the result.

#### Returns

True if location subsystem is ready for service otherwise false.

#### Deprecated

use [getServiceStatus\(\)](#)

#### 4.18.1.39.3.2 `virtual telux::common::ServiceStatus telux::loc::ILocationManager::getServiceStatus ( ) [pure virtual]`

This status indicates whether the object is in a usable state.

#### Returns

SERVICE\_AVAILABLE - If location manager is ready for service. SERVICE\_UNAVAILABLE - If location manager is temporarily unavailable. SERVICE\_FAILED - If location manager encountered an irrecoverable failure.

#### 4.18.1.39.3.3 `virtual std::future<bool> telux::loc::ILocationManager::onSubsystemReady ( ) [pure virtual]`

Wait for location subsystem to be ready.

#### Returns

A future that caller can wait on to be notified when location subsystem is ready.

#### Deprecated

The callback mechanism introduced in the [LocationFactory::getLocationManager\(\)](#) API will provide the similar notification mechanism as [onSubsystemReady\(\)](#). This API will soon be removed from further releases.

#### 4.18.1.39.3.4 `virtual telux::common::Status telux::loc::ILocationManager::registerListenerEx ( std::weak_ptr< ILocationListener > listener ) [pure virtual]`

Register a listener for specific updates from location manager like location, jamming info and satellite vehicle info. If enhanced position, using Dead Reckoning etc., is enabled, enhanced fixes will be provided. Otherwise raw GNSS fixes will be provided. The position reports will start only when `startDetailedReports` or `startBasicReports` is invoked.



**Parameters**

in	<i>listener</i>	- Pointer of <a href="#">ILocationListener</a> object that processes the notification.
----	-----------------	--

**Returns**

Status of registerListener i.e success or suitable status code.

**4.18.1.39.3.5** `virtual telux::common::Status telux::loc::ILocationManager::deRegisterListenerEx ( std::weak_ptr< ILocationListener > listener ) [pure virtual]`

Remove a previously registered listener.

**Parameters**

in	<i>listener</i>	- Previously registered <a href="#">ILocationListener</a> that needs to be removed.
----	-----------------	---

**Returns**

Status of removeListener success or suitable status code

**4.18.1.39.3.6** `virtual telux::common::Status telux::loc::ILocationManager::startDetailedReports ( uint32_t interval, telux::common::ResponseCallback callback = nullptr, GnssReportTypeMask reportMask = DEFAULT_GNSS_REPORT ) [pure virtual]`

Starts the richer location reports by configuring the time between them as the interval. The reports generated after invoking this API are from the FUSED Engine type. Any of the 3 APIs that is startDetailedReports or startDetailedEngineReports or startBasicReports can be called one after the other irrespective of order, without calling stopReports in between any of them and the API which is called last will be honored for providing the callbacks. In case of multiple clients invoking this API with different intervals, if the platforms is configured, then the clients will receive the reports at their requested intervals. If not configured then all the clients will be serviced at the smallest interval among all clients' intervals. The supported periodicities are 100ms, 200ms, 500ms, 1sec, 2sec, nsec and a periodicity that a caller send which is not one of these will result in the implementation picking one of these periodicities. Calling this Api will result in [ILocationListener::onDetailedLocationUpdate](#), [ILocationListener::onGnssSVInfo](#), [ILocationListener::onGnssSignalInfo](#), [ILocationListener::onGnssNmeaInfo](#), [ILocationListener::onGnssMeasurementsInfo](#) and [ILocationListener::onGnssDisasterCrisisInfo](#) APIs on the listener being invoked, assuming they have not been disabled using the GnssReportTypeMask. If a client issues second request to this API then new request for GnssReportTypeMask will over write the previous call to this API.

The NMEA sentences received can be configured via [ILocationConfigurator::configureNmea](#).

On platforms with Access control enabled, caller needs to have TELUX\_LOC\_DATA permission to invoke this API successfully.

**Parameters**

in	<i>interval</i>	- Minimum time interval between two consecutive reports in milliseconds.
----	-----------------	--

E.g. If minInterval is 1000 milliseconds, reports will be provided with a periodicity of 1 second or more depending on the number of applications listening to location updates.

**Parameters**

in	<i>callback</i>	- Optional callback to get the response of set minimum interval for reports.
in	<i>reportMask</i>	- Optional field to specify which reports a client is interested in. By default all the reports will be enabled.

**Returns**

Status of startDetailedReports i.e. success or suitable status code.

```
4.18.1.39.3.7 virtual telux::common::Status telux::loc::ILocationManager::startDetailedEngineReports
( uint32_t interval, LocReqEngine engineType, telux::common::ResponseCallback
callback = nullptr, GnssReportTypeMask reportMask = DEFAULT_GNSS_REPORT )
[pure virtual]
```

Starts a session which may provide richer default combined position reports and position reports from specific engines. The fused position report type will always be supported if at least one engine in the system is producing valid report. Any of the 3 APIs that is startDetailedReports or startDetailedEngineReports or startBasicReports can be called one after the other irrespective of order, without calling stopReports in between any of them and the API which is called last will be honored for providing the callbacks. In case of multiple clients invoking this API with different intervals, if the platforms is configured, then the clients will receive the reports at their requested intervals. If not configured then all the clients will be serviced at the smallest interval among all clients' intervals. The supported periodicities are 100ms, 200ms, 500ms, 1sec, 2sec, nsec and a periodicity that a caller send which is not one of these will result in the implementation picking one of these periodicities. Calling this Api will result in [ILocationListener::onDetailedEngineLocationUpdate](#), [ILocationListener::onGnssSVInfo](#), [ILocationListener::onGnssSignalInfo](#), [ILocationListener::onGnssNmeaInfo](#), [ILocationListener::onEngineNmeaInfo](#), [ILocationListener::onGnssMeasurementsInfo](#) and [ILocationListener::onGnssDisasterCrisisInfo](#) APIs on the listener being invoked, assuming they have not been disabled using the GnssReportTypeMask. If a client issues second request to this API then new request for GnssReportTypeMask will over write the previous call to this API.

Usage of NMEA Sentences:

NMEA updates can be received by either: a) Setting the telux::loc::GnssReportType::NMEA bit in the reportMask passed as a paramter to this API and receive the sentences via [ILocationListener::onGnssNmeaInfo](#). b) Setting the telux::loc::GnssReportType::ENGINE\_NMEA bit in the reportMask passed as a paramter to this API and receive the sentences via [ILocationListener::onEngineNmeaInfo](#).

When clients set the GnssReportType::NMEA bit in the reportMask passed as a parameter to [ILocationManager::startDetailedEngineReports](#), the NMEA sentences are always generated by FUSED engine and are received via [ILocationListener::onGnssNmeaInfo](#). Clients can also configure the NMEA

sentences to be received via [ILocationConfigurator::configureNmea](#).

Additionally, clients have the ability to receive NMEA sentences for a specific engineType mask via [ILocationListener::onEngineNmeaInfo](#). To receive the NMEA updates for a specific engine type, clients should configure the NMEA sentences for the specific engineType mask via [ILocationConfigurator::configureNmea](#). Next, while invoking [ILocationManager::startDetailedEngineReports](#), clients need to set the `telux::loc::GnssReportType::ENGINE_NMEA` bit in the `reportMask`. The engineType mask passed as a parameter to this API should at least contain the engines configured via the [ILocationConfigurator::configureNmea](#) API. The intended NMEA updates will be received via [ILocationListener::onEngineNmeaInfo](#).

Understanding with an example - Client configures a few NMEA sentences via [ILocationConfigurator::configureNmea](#) with the engineType mask set as PPE and FUSED. [Fused engine is always considered as set even if the client does not explicitly specify it.] Client invokes [startDetailedEngineReports](#) via [ILocationManager::startDetailedEngineReports](#) by setting the `telux::loc::GnssReportType::NMEA` bit in the `reportMask` and setting the engineType mask as just PPE. Since both the engineType masks contain PPE, the NMEA updates generated by PPE will be received via [ILocationListener::onEngineNmeaInfo](#). However, NMEA updates from FUSED engine will not be received since the engine mask for this API is set to only PPE.

If client sets the engineType mask as SPE while trying to configure NMEA sentences and sets engineType mask as PPE while trying to invoke the detailed engine reports, no NMEA updates will be received via [ILocationListener::onEngineNmeaInfo](#) since there is NO intersection between the 2 masks.

On platforms with Access control enabled, caller needs to have `TELUX_LOC_DATA` permission to invoke this API successfully.

#### Parameters

in	<i>interval</i>	- Minimum time interval between two consecutive reports in milliseconds.
----	-----------------	--

E.g. If `minInterval` is 1000 milliseconds, reports will be provided with a periodicity of 1 second or more depending on the number of applications listening to location updates.

#### Parameters

in	<i>engineType</i>	- The type of engine requested for fixes such as SPE or PPE or FUSED. The FUSED includes all the engines that are running to generate the fixes such as reports from SPE, PPE and DRE.
in	<i>callback</i>	- Optional callback to get the response of set minimum interval for reports.
in	<i>reportMask</i>	- Optional field to specify which reports a client is interested in. By default all the reports will be enabled.

#### Returns

Status of `startDetailedEngineReports` i.e. success or suitable status code.

**4.18.1.39.3.8** `virtual telux::common::Status telux::loc::ILocationManager::startBasicReports ( uint32_t distanceInMeters, uint32_t intervalInMs, telux::common::ResponseCallback callback = nullptr ) [pure virtual]`

Starts the Location report by configuring the time and distance between the consecutive reports. Any of the 3 APIs that is startDetailedReports or startDetailedEngineReports or startBasicReports can be called one after the other irrespective of order, without calling stopReports in between any of them and the API which is called last will be honored for providing the callbacks. In case of multiple clients invoking this API with different intervals, if the platforms is configured, then the clients will receive the reports at their requested intervals. If not configured then all the clients will be serviced at the smallest interval among all clients' intervals. The supported periodicities are 100ms, 200ms, 500ms, 1sec, 2sec, nsec and a periodicity that a caller send which is not one of these will result in the implementation picking one of these periodicities. This Api enables the onBasicLocationUpdate Api on the listener. Please note that these reports are generated by FUSED Engine type.

On platforms with Access control enabled, caller needs to have TELUX\_LOC\_DATA permission to invoke this API successfully.

E.g. If intervalInMs is 1000 milliseconds and distanceInMeters is 100m, reports will be provided according to the condition that happens first. So we need to provide both the parameters for evaluating the report.

The underlying system may have a minimum distance threshold(e.g. 1 meter). Effective distance will not be smaller than this lower bound.

The effective distance may have a granularity level higher than 1 m, e.g. 5 m. So distanceInMeters being 59 may be honored at 60 m, depending on the system.

Where there is another application in the system having a session with shorter distance, this client may benefit and receive reports at that distance.

#### Parameters

in	<i>distanceInMeters</i>	- DistanceInMeters between two consecutive reports in meters. This parameter is not used.
in	<i>intervalInMs</i>	- Minimum time interval between two consecutive reports in milliseconds.
in	<i>callback</i>	- Optional callback to get the response of set minimum distance for reports.

#### Returns

Status of startBasicReports i.e. success or suitable status code.

**4.18.1.39.3.9** `virtual telux::common::Status telux::loc::ILocationManager::registerForSystemInfo↔ Updates ( std::weak_ptr< ILocationSystemInfoListener > listener, telux::common::↔ ResponseCallback callback = nullptr ) [pure virtual]`

This API registers a [ILocationSystemInfoListener](#) listener and will receive information related to location system that are not tied with location fix session, e.g.: next leap second event. The startBasicReports, startDetailedReports, startDetailedEngineReports does not need to be called before calling this API, in order to receive updates.

**Parameters**

in	<i>listener</i>	- Pointer of <a href="#">ILocationSystemInfoListener</a> object.
in	<i>callback</i>	- Optional callback to get the response of location system info.

**Returns**

Status of getLocationSystemInfo i.e success or suitable status code.

**4.18.1.39.3.10** `virtual telux::common::Status telux::loc::ILocationManager::deRegisterForSystemInfoUpdates ( std::weak_ptr< ILocationSystemInfoListener > listener, telux::common::ResponseCallback callback = nullptr ) [pure virtual]`

This API removes a previously registered listener and will also stop receiving informations related to location system for that particular listener.

**Parameters**

in	<i>listener</i>	- Previously registered <a href="#">ILocationSystemInfoListener</a> that needs to be removed.
in	<i>callback</i>	- Optional callback to get the response of location system info.

**Returns**

Status of deRegisterForSystemInfoUpdates success or suitable status code.

**4.18.1.39.3.11** `virtual telux::common::Status telux::loc::ILocationManager::requestEnergyConsumedInfo ( GetEnergyConsumedCallback cb ) [pure virtual]`

This API receives information on energy consumed by modem GNSS engine. If this API is called on this object while this is already a pending request, then it will overwrite the callback to be invoked and the callback from the previous invocation will not be called.

**Parameters**

in	<i>cb</i>	- callback to get the information of Gnss energy consumed.
----	-----------	--

**Returns**

Status of requestEnergyConsumedInfo i.e success or suitable status code.

**4.18.1.39.3.12** `virtual telux::common::Status telux::loc::ILocationManager::stopReports ( telux::common::ResponseCallback callback = nullptr ) [pure virtual]`

This API will stop reports started using startDetailedReports or startBasicReports or registerListener or setMinIntervalForReports.

On platforms with Access control enabled, caller needs to have TELUX\_LOC\_DATA permission to invoke this API successfully.

**Parameters**

in	<i>callback</i>	- Optional callback to get the response of stop reports.
----	-----------------	--

**Returns**

Status of stopReports i.e. success or suitable status code.

#### 4.18.1.39.3.13 virtual telux::common::Status telux::loc::ILocationManager::getYearOfHw ( GetYearOfHwCallback *cb* ) [pure virtual]

This API retrieves the year of hardware information.

**Parameters**

in	<i>cb</i>	- callback to get information of year of hardware.
----	-----------	--

**Returns**

Status of getYearOfHw i.e success or suitable status code.

#### 4.18.1.39.3.14 virtual telux::common::Status telux::loc::ILocationManager::getTerrestrialPosition ( uint32\_t *timeoutMsec*, TerrestrialTechnology *techMask*, GetTerrestrialInfoCallback *cb*, telux::common::ResponseCallback *callback = nullptr* ) [pure virtual]

This API retrieves single-shot terrestrial position using the set of specified terrestrial technologies. This API can be invoked even while there is an on-going tracking session that was started using startBasicReports/startDetailedReports/startDetailedEngineReports. If this API is invoked while there is already a pending request for terrestrial position, the request will fail and [telux::common::ResponseCallback](#) will get invoked with [telux::common::ErrorCode::OP\\_IN\\_PROGRESS](#). To cancel a pending request, use [ILocationManager::cancelTerrestrialPositionRequest](#). Before using this API, user consent needs to be set true via [ILocationConfigurator::provideConsentForTerrestrialPositioning](#).

On platforms with Access control enabled, caller needs to have TELUX\_LOC\_DATA permission to invoke this API successfully.

**Parameters**

in	<i>timeoutMsec</i>	- the time in milliseconds within which the client is expecting a response. If the system is unable to provide a report within this time, the <a href="#">telux::common::ResponseCallback</a> will be invoked with <a href="#">telux::common::ErrorCode::OPERATION_TIMEOUT</a> .
in	<i>techMask</i>	- the set of terrestrial technologies that are allowed to be used for producing the position.
in	<i>cb</i>	- callback to receive terrestrial position. This callback will only be invoked when ResponseCallback is invoked with SUCCESS.
in	<i>callback</i>	- Optional callback to get the response of getTerrestrialPosition.

**Returns**

Status of `getTerrestrialPosition` i.e success or suitable status code.

**4.18.1.39.3.15** `virtual telux::common::Status telux::loc::ILocationManager::cancelTerrestrialPositionRequest ( telux::common::ResponseCallback callback = nullptr ) [pure virtual]`

This API cancels the pending request invoked by `ILocationManager::getTerrestrialPosition`. If this API is invoked while there is no pending request for terrestrial position from `ILocationManager::getTerrestrialPosition`, then `telux::common::ResponseCallback` will be invoked with `telux::common::ErrorCode::INVALID_ARGUMENTS`.

On platforms with Access control enabled, caller needs to have `TELUX_LOC_DATA` permission to invoke this API successfully.

**Parameters**

in	<i>callback</i>	- Optional callback to get the response of <code>cancelTerrestrialPositionRequest</code> .
----	-----------------	--

**Returns**

Status of `cancelTerrestrialPositionRequest` i.e success or suitable status code.

**4.18.1.39.3.16** `virtual telux::loc::LocCapability telux::loc::ILocationManager::getCapabilities ( ) [pure virtual]`

This API retrieves capability information.

**Returns**

Status of `getCapabilities` i.e success or suitable status code.

**4.18.2 Enumeration Type Documentation****4.18.2.1 enum telux::loc::DgnssDataFormat [strong]**

Defines RTCM injection data format

**Enumerator**

***DATA\_FORMAT\_UNKNOWN*** Source data format is unknown

***DATA\_FORMAT\_RTCM\_3*** Source data format is RTCM\_3

***DATA\_FORMAT\_3GPP\_RTK\_R15*** Source data format is 3GPP RTK Rel-15

**4.18.2.2 enum telux::loc::DgnssStatus [strong]**

Defines status reported by cdfw for RTCM injection.

**Enumerator**

- DATA\_SOURCE\_NOT\_SUPPORTED** Dgnss subsystem doesn't support the data source
- DATA\_FORMAT\_NOT\_SUPPORTED** Dgnss subsystem doesn't support the data format
- OTHER\_SOURCE\_IN\_USE** After the source injects the data, dgnss subsystem discovers there is another higher priority source injecting the data at the same time, and the current injected data is dropped
- MESSAGE\_PARSE\_ERROR** There is a parsing error such as unrecognized format, CRC check failure, value range check failure, etc.; the injected data is dropped
- DATA\_SOURCE\_USABLE** Data source is usable
- DATA\_SOURCE\_NOT\_USABLE** Data source is not usable, for example, the reference station is too far away to improve the position accuracy
- CDFW\_STOP\_SOURCE\_INJECT** The CDFW service asks the source client to stop injecting the correction data

**4.18.2.3 enum telux::loc::HorizontalAccuracyLevel [strong]**

Defines the horizontal accuracy level of the fix.

**Enumerator**

- LOW** Client requires low horizontal accuracy
- MEDIUM** Client requires medium horizontal accuracy
- HIGH** Client requires high horizontal accuracy

**4.18.2.4 enum telux::loc::LocationReliability [strong]**

Specifies the reliability of the position.

**Enumerator**

- UNKNOWN** Unknown location reliability
- NOT\_SET** Location reliability is not set. The reliability of this position report could not be determined. It could be unreliable/reliable
- VERY\_LOW** Location reliability is very low
- LOW** Location reliability is low, little or no cross-checking is possible
- MEDIUM** Location reliability is medium, limited cross-check passed
- HIGH** Location reliability is high, strong cross-check passed

**4.18.2.5 enum telux::loc::SbasCorrectionType**

Specify set of navigation solutions that contribute to Gnss Location. Defines Satellite Based Augmentation System (SBAS) corrections. SBAS contributes to improve the performance of GNSS system.

**Enumerator**

- SBAS\_CORRECTION\_IONO** Bit mask to specify whether SBAS ionospheric correction is used
- SBAS\_CORRECTION\_FAST** Bit mask to specify whether SBAS fast correction is used
- SBAS\_CORRECTION\_LONG** Bit mask to specify whether SBAS long correction is used
- SBAS\_INTEGRITY** Bit mask to specify whether SBAS integrity information is used
- SBAS\_CORRECTION\_DGNSS** Bit mask to specify whether SBAS DGNSS correction is used
- SBAS\_CORRECTION\_RTK** Bit mask to specify whether SBAS RTK correction is used



**SBAS\_CORRECTION\_PPP** Bit mask to specify whether SBAS PPP correction is used  
**SBAS\_CORRECTION\_RTK\_FIXED** Bit mask to specify whether SBAS RTK fixed correction is used  
**SBAS\_CORRECTION\_ONLY\_SBAS\_CORRECTED\_SV\_USED** Bit mask to specify only SBAS corrected SV is used  
**SBAS\_COUNT** Bitset

#### 4.18.2.6 enum telux::loc::AltitudeType [strong]

Indicates whether altitude is assumed or calculated.

##### Enumerator

**UNKNOWN** Unknown altitude type  
**CALCULATED** Altitude is calculated  
**ASSUMED** Altitude is assumed, there may not be enough satellites to determine the precise altitude

#### 4.18.2.7 enum telux::loc::GnssConstellationType [strong]

Defines constellation type of GNSS.

##### Enumerator

**UNKNOWN** Unknown constellation type  
**GPS** GPS satellite  
**GALILEO** GALILEO satellite  
**SBAS** SBAS satellite  
**COMPASS** COMPASS satellite.

##### Deprecated

constellation type is not supported.

**GLONASS** GLONASS satellite  
**BDS** BDS satellite  
**QZSS** QZSS satellite  
**NAVIC** NAVIC satellite

#### 4.18.2.8 enum telux::loc::SVHealthStatus [strong]

Health status indicates whether satellite is operational or not. This information comes from the most recent data transmitted in satellite almanacs.

##### Enumerator

**UNKNOWN** Unknown sv health status  
**UNHEALTHY** satellite is not operational and cannot be used in position calculations  
**HEALTHY** satellite is fully operational

#### 4.18.2.9 enum telux::loc::SVStatus [strong]

Satellite vehicle processing status.

##### Enumerator

**UNKNOWN** Unknown sv status  
**IDLE** SV is not being actively processed  
**SEARCH** The system is searching for this SV  
**TRACK** SV is being tracked

#### 4.18.2.10 enum telux::loc::SVInfoAvailability [strong]

Indicates whether Satellite Vehicle info like ephemeris and almanac are present or not

##### Enumerator

**UNKNOWN** Unknown sv info availability  
**YES** Ephemeris or Almanac exists  
**NO** Ephemeris or Almanac doesn't exist

#### 4.18.2.11 enum telux::loc::GnssPositionTechType

Specifies which position technology was used to generate location information in the [ILocationInfoEx](#).

##### Enumerator

**GNSS\_DEFAULT** Technology used to generate location info is unknown.  
**GNSS\_SATELLITE** Satellites-based technology was used to generate location info.  
**GNSS\_CELLID** Cell towers were used to generate location info.  
**GNSS\_WIFI** Wi-Fi access points were used to generate location info.  
**GNSS\_SENSORS** Sensors were used to generate location info.  
**GNSS\_REFERENCE\_LOCATION** Reference location was used to generate location info.  
**GNSS\_INJECTED\_COARSE\_POSITION** Coarse position injected into the location engine was used to generate location info.  
**GNSS\_AFLT** AFLT was used to generate location info.  
**GNSS\_HYBRID** GNSS and network-provided measurements were used to generate location info.  
**GNSS\_PPE** Precise position engine was used to generate location info.  
**GNSS\_VEHICLE** Location was calculated using Vehicular data.  
**GNSS\_VISUAL** Location was calculated using Visual data.  
**GNSS\_PROPAGATED** Location was calculated using Propagation logic, which uses cached measurements.

#### 4.18.2.12 enum telux::loc::KinematicDataValidityType

Specifies related kinematics mask

**Enumerator**

**HAS\_LONG\_ACCEL** Navigation data has Forward Acceleration  
**HAS\_LAT\_ACCEL** Navigation data has Sideward Acceleration  
**HAS\_VERT\_ACCEL** Navigation data has Vertical Acceleration  
**HAS\_YAW\_RATE** Navigation data has Heading Rate  
**HAS\_PITCH** Navigation data has Body pitch  
**HAS\_LONG\_ACCEL\_UNC** Navigation data has Forward Acceleration  
**HAS\_LAT\_ACCEL\_UNC** Navigation data has Sideward Acceleration  
**HAS\_VERT\_ACCEL\_UNC** Navigation data has Vertical Acceleration  
**HAS\_YAW\_RATE\_UNC** Navigation data has Heading Rate  
**HAS\_PITCH\_UNC** Navigation data has Body pitch  
**HAS\_PITCH\_RATE\_BIT** Navigation data has Body pitch rate  
**HAS\_PITCH\_RATE\_UNC\_BIT** Navigation data has Body pitch rate uncertainty  
**HAS\_ROLL\_BIT** Navigation data has roll  
**HAS\_ROLL\_UNC\_BIT** Navigation data has roll uncertainty  
**HAS\_ROLL\_RATE\_BIT** Navigation data has roll rate  
**HAS\_ROLL\_RATE\_UNC\_BIT** Navigation data has roll rate uncertainty  
**HAS\_YAW\_BIT** Navigation data has yaw  
**HAS\_YAW\_UNC\_BIT** Navigation data has yaw uncertainty

**4.18.2.13 enum telux::loc::GnssSystem [strong]**

Specify the different types of constellation supported.

**Enumerator**

**GNSS\_LOC\_SV\_SYSTEM\_UNKNOWN** UNKNOWN satellite.  
**GNSS\_LOC\_SV\_SYSTEM\_GPS** GPS satellite.  
**GNSS\_LOC\_SV\_SYSTEM\_GALILEO** GALILEO satellite.  
**GNSS\_LOC\_SV\_SYSTEM\_SBAS** SBAS satellite.  
**GNSS\_LOC\_SV\_SYSTEM\_COMPASS** COMPASS satellite.

**Deprecated**

constellation type is not supported.

**GNSS\_LOC\_SV\_SYSTEM\_GLONASS** GLONASS satellite.  
**GNSS\_LOC\_SV\_SYSTEM\_BDS** BDS satellite.  
**GNSS\_LOC\_SV\_SYSTEM\_QZSS** QZSS satellite.  
**GNSS\_LOC\_SV\_SYSTEM\_NAVIC** NAVIC satellite.

**4.18.2.14 enum telux::loc::GnssTimeValidityType**

Validity field for different system time in struct [TimeInfo](#).

**Enumerator**

**GNSS\_SYSTEM\_TIME\_WEEK\_VALID** valid systemWeek.  
**GNSS\_SYSTEM\_TIME\_WEEK\_MS\_VALID** valid systemMsec  
**GNSS\_SYSTEM\_CLK\_TIME\_BIAS\_VALID** valid systemClkTimeBias  
**GNSS\_SYSTEM\_CLK\_TIME\_BIAS\_UNC\_VALID** valid systemClkTimeUncMs

***GNSS\_SYSTEM\_REF\_FCOUNT\_VALID*** valid refFCount  
***GNSS\_SYSTEM\_NUM\_CLOCK\_RESETS\_VALID*** valid numClockResets

#### 4.18.2.15 enum telux::loc::GlonassTimeValidity

Validity field for GLONASS time in struct [GlonassTimeInfo](#).

##### Enumerator

***GNSS\_CLO\_DAYS\_VALID*** valid gloDays  
***GNSS\_GLOS\_MSEC\_VALID*** valid gloMsec  
***GNSS\_GLO\_CLK\_TIME\_BIAS\_VALID*** valid gloClkTimeBias  
***GNSS\_GLO\_CLK\_TIME\_BIAS\_UNC\_VALID*** valid gloClkTimeUncMs  
***GNSS\_GLO\_REF\_FCOUNT\_VALID*** valid refFCount  
***GNSS\_GLO\_NUM\_CLOCK\_RESETS\_VALID*** valid numClockResets  
***GNSS\_GLO\_FOUR\_YEAR\_VALID*** valid gloFourYear

#### 4.18.2.16 enum telux::loc::GnssSignalType

Specify GNSS Signal Type and RF Band used in struct [GnssMeasurementInfo](#) and [ISVInfo](#) class.

##### Enumerator

***GPS\_L1CA*** Gnss signal is of GPS L1CA RF Band.  
***GPS\_L1C*** Gnss signal is of GPS L1C RF Band.  
***GPS\_L2*** Gnss signal is of GPS L2 RF Band.  
***GPS\_L5*** Gnss signal is of GPS L5 RF Band.  
***GLONASS\_G1*** Gnss signal is of GLONASS G1 (L1OF) RF Band.  
***GLONASS\_G2*** Gnss signal is of GLONASS G2 (L2OF) RF Band.  
***GALILEO\_E1*** Gnss signal is of GALILEO E1 RF Band.  
***GALILEO\_E5A*** Gnss signal is of GALILEO E5A RF Band.  
***GALILEO\_E5B*** Gnss signal is of GALILEO E5B RF Band.  
***BEIDOU\_B1*** Gnss signal is of BEIDOU B1 RF Band.  
***BEIDOU\_B2*** Gnss signal is of BEIDOU B2 RF Band.  
***QZSS\_L1CA*** Gnss signal is of QZSS L1CA RF Band.  
***QZSS\_L1S*** Gnss signal is of QZSS L1S RF Band.  
***QZSS\_L2*** Gnss signal is of QZSS L2 RF Band.  
***QZSS\_L5*** Gnss signal is of QZSS L5 RF Band.  
***SBAS\_L1*** Gnss signal is of SBAS L1 RF Band.  
***BEIDOU\_B1I*** Gnss signal is of BEIDOU B1I RF Band.  
***BEIDOU\_B1C*** Gnss signal is of BEIDOU B1C RF Band.  
***BEIDOU\_B2I*** Gnss signal is of BEIDOU B2I RF Band.  
***BEIDOU\_B2AI*** Gnss signal is of BEIDOU B2AI RF Band.  
***NAVIC\_L5*** Gnss signal is of NAVIC L5 RF Band.  
***BEIDOU\_B2AQ*** Gnss signal is of BEIDOU B2A\_Q RF Band.

#### 4.18.2.17 enum telux::loc::LocCapabilityType

Specify Location Capabilities Type.

**Enumerator**

- TIME\_BASED\_TRACKING** Support time based tracking session via [ILocationManager::startDetailedReports](#), [ILocationManager::startDetailedEngineReports](#) and [ILocationManager::startBasicReports](#) with `distanceInMeters` set to 0.
- DISTANCE\_BASED\_TRACKING** Support distance based tracking session via [ILocationManager::startBasicReports](#) with `distanceInMeters` specified.
- GNSS\_MEASUREMENTS** Support Gns Measurement data via [ILocationListener::onGnsMeasurementsInfo](#) when a tracking session is enabled.
- CONSTELLATION\_ENABLEMENT** Support configure constellations via [ILocationConfigurator::configureConstellations](#).
- CARRIER\_PHASE** Support carrier phase for Precise Positioning Measurement Engine (PPME).
- QWES\_GNSS\_SINGLE\_FREQUENCY** Support GNSS Single Frequency feature.
- QWES\_GNSS\_MULTI\_FREQUENCY** Supports GNSS Multi Frequency feature.
- QWES\_VPE** Support VEPP license bundle is enabled. VEPP bundle include Carrier Phase features.
- QWES\_CV2X\_LOCATION\_BASIC** Support for CV2X Location basic features. This includes features for GTS Time & Freq, [ILocationConfigurator::configureCTunc](#).
- QWES\_CV2X\_LOCATION\_PREMIUM** Support for CV2X Location premium features. This includes features for CV2X Location Basic features, QDR3 feature and [ILocationConfigurator::configurePACE](#).
- QWES\_PPE** Support PPE (Precise Positioning Engine) library is enabled or Precise Positioning Framework (PPF) is available. This includes features for Carrier Phase and SV Ephemeris.
- QWES\_QDR2** Support QDR2\_C license bundle is enabled.
- QWES\_QDR3** Support QDR3\_C license bundle is enabled.
- TIME\_BASED\_BATCHING** support time-based batching session.
- DISTANCE\_BASED\_BATCHING** support distance-based batching session.
- GEOFENCE** Support geofencing.
- OUTDOOR\_TRIP\_BATCHING** Support outdoor trip batching session.
- SV\_POLYNOMIAL** Support SV Polynomial
- NLOS\_ML20** Indicates presence of ML Inference capability for Pseudo Range Measurements.

**4.18.2.18 enum telux::loc::LocationTechnologyType**

Specify the set of technologies that contribute to [ILocationInfoBase](#).

**Enumerator**

- LOC\_GNSS** Location was calculated using GNSS-based technology.
- LOC\_CELL** Location was calculated using Cell-based technology.
- LOC\_WIFI** Location was calculated using WiFi-based technology.
- LOC\_SENSORS** Location was calculated using Sensors-based technology.
- LOC\_REFERENCE\_LOCATION** Location was calculated using Reference location.
- LOC\_INJECTED\_COARSE\_POSITION** Location was calculated using Coarse position injected into the location engine.
- LOC\_AFLT** Location was calculated using AFLT.
- LOC\_HYBRID** Location was calculated using GNSS and network-provided measurements.
- LOC\_PPE** Location was calculated using Precise position engine.
- LOC\_VEH** Location was calculated using Vehicular data.
- LOC\_VIS** Location was calculated using Visual data.
- LOC\_PROPAGATED** Location was calculated using Propagation logic, which uses cached measurements.

#### 4.18.2.19 enum telux::loc::LocationValidityType

Specify the valid fields in LocationInfoValidity User should determine whether a field in LocationInfoValidity is valid or not by checking the corresponding bit is set or not.

##### Enumerator

**HAS\_LAT\_LONG\_BIT** Location has valid latitude and longitude.  
**HAS\_ALTITUDE\_BIT** Location has valid altitude.  
**HAS\_SPEED\_BIT** Location has valid speed.  
**HAS\_HEADING\_BIT** Location has valid heading.  
**HAS\_HORIZONTAL\_ACCURACY\_BIT**  
**HAS\_VERTICAL\_ACCURACY\_BIT** Location has valid vertical accuracy.  
**HAS\_SPEED\_ACCURACY\_BIT** Location has valid speed accuracy.  
**HAS\_HEADING\_ACCURACY\_BIT** Location has valid heading accuracy.  
**HAS\_TIMESTAMP\_BIT** Location has valid timestamp.  
**HAS\_ELAPSED\_REAL\_TIME\_BIT** Location has valid elapsed real time.  
**HAS\_ELAPSED\_REAL\_TIME\_UNC\_BIT** Location has valid elapsed real time uncertainty.

#### 4.18.2.20 enum telux::loc::LocationInfoExValidityType

Specify the valid fields in LocationInfoExValidityType. User should determine whether a field in LocationInfoExValidityType is valid or not by checking the corresponding bit is set or not.

##### Enumerator

**HAS\_ALTITUDE\_MEAN\_SEA\_LEVEL** valid altitude mean sea level  
**HAS\_DOP** valid pdop, hdop, and vdop  
**HAS\_MAGNETIC\_DEVIATION** valid magnetic deviation  
**HAS\_HOR\_RELIABILITY** valid horizontal reliability  
**HAS\_VER\_RELIABILITY** valid vertical reliability  
**HAS\_HOR\_ACCURACY\_ELIP\_SEMI\_MAJOR** valid elipsode semi major  
**HAS\_HOR\_ACCURACY\_ELIP\_SEMI\_MINOR** valid elipsode semi minor  
**HAS\_HOR\_ACCURACY\_ELIP\_AZIMUTH** valid accuracy elipsode azimuth  
**HAS\_GNSS\_SV\_USED\_DATA** valid gnss sv used in pos data  
**HAS\_NAV\_SOLUTION\_MASK** valid navSolutionMask  
**HAS\_POS\_TECH\_MASK** valid LocPosTechMask  
**HAS\_SV\_SOURCE\_INFO** valid LocSvInfoSource  
**HAS\_POS\_DYNAMICS\_DATA** valid position dynamics data  
**HAS\_EXT\_DOP** valid gdop, tdop  
**HAS\_NORTH\_STD\_DEV** valid North standard deviation  
**HAS\_EAST\_STD\_DEV** valid East standard deviation  
**HAS\_NORTH\_VEL** valid North Velocity  
**HAS\_EAST\_VEL** valid East Velocity  
**HAS\_UP\_VEL** valid Up Velocity  
**HAS\_NORTH\_VEL\_UNC** valid North Velocity Uncertainty  
**HAS\_EAST\_VEL\_UNC** valid East Velocity Uncertainty  
**HAS\_UP\_VEL\_UNC** valid Up Velocity Uncertainty  
**HAS\_LEAP\_SECONDS** valid leap\_seconds  
**HAS\_TIME\_UNC** valid timeUncMs  
**HAS\_NUM\_SV\_USED\_IN\_POSITION** valid number of sv used

**HAS\_CALIBRATION\_CONFIDENCE\_PERCENT** valid sensor calibrationConfidencePercent  
**HAS\_CALIBRATION\_STATUS** valid sensor calibrationConfidence  
**HAS\_OUTPUT\_ENG\_TYPE** valid output engine type  
**HAS\_OUTPUT\_ENG\_MASK** valid output engine mask  
**HAS\_CONFORMITY\_INDEX\_FIX** valid conformity index  
**HAS\_LLA\_VRP\_BASED** valid lla vrp based  
**HAS\_ENU\_VELOCITY\_VRP\_BASED** valid enu velocity vrp based  
**HAS\_ALTITUDE\_TYPE** valid altitude type  
**HAS\_REPORT\_STATUS** valid report status  
**HAS\_INTEGRITY\_RISK\_USED** valid integrity risk  
**HAS\_PROTECT\_LEVEL\_ALONG\_TRACK** valid protect level along track  
**HAS\_PROTECT\_LEVEL\_CROSS\_TRACK** valid protect level cross track  
**HAS\_PROTECT\_LEVEL\_VERTICAL** valid protect level vertical  
**HAS\_SOLUTION\_STATUS** valid DR Solution status

#### 4.18.2.21 enum telux::loc::GnssDataSignalTypes

Specify the GNSS signal type and RF band for jammer info and automatic gain control metric in [GnssData](#).

##### Enumerator

**GNSS\_DATA\_SIGNAL\_TYPE\_GPS\_L1CA** GPS L1CA RF Band.  
**GNSS\_DATA\_SIGNAL\_TYPE\_GPS\_L1C** GPS L1C RF Band.  
**GNSS\_DATA\_SIGNAL\_TYPE\_GPS\_L2C\_L** GPS L2C\_L RF Band.  
**GNSS\_DATA\_SIGNAL\_TYPE\_GPS\_L5\_Q** GPS L5\_Q RF Band.  
**GNSS\_DATA\_SIGNAL\_TYPE\_GLONASS\_G1** GLONASS G1 (L1OF) RF Band.  
**GNSS\_DATA\_SIGNAL\_TYPE\_GLONASS\_G2** GLONASS G2 (L2OF) RF Band.  
**GNSS\_DATA\_SIGNAL\_TYPE\_GALILEO\_E1\_C** GALILEO E1\_C RF Band.  
**GNSS\_DATA\_SIGNAL\_TYPE\_GALILEO\_E5A\_Q** GALILEO E5A\_Q RF Band.  
**GNSS\_DATA\_SIGNAL\_TYPE\_GALILEO\_E5B\_Q** GALILEO E5B\_Q RF Band.  
**GNSS\_DATA\_SIGNAL\_TYPE\_BEIDOU\_B1\_I** BEIDOU B1\_I RF Band.  
**GNSS\_DATA\_SIGNAL\_TYPE\_BEIDOU\_B1C** BEIDOU B1C RF Band.  
**GNSS\_DATA\_SIGNAL\_TYPE\_BEIDOU\_B2\_I** BEIDOU B2\_I RF Band.  
**GNSS\_DATA\_SIGNAL\_TYPE\_BEIDOU\_B2A\_I** BEIDOU B2A\_I RF Band.  
**GNSS\_DATA\_SIGNAL\_TYPE\_QZSS\_L1CA** QZSS L1CA RF Band.  
**GNSS\_DATA\_SIGNAL\_TYPE\_QZSS\_L1S** QZSS L1S RF Band.  
**GNSS\_DATA\_SIGNAL\_TYPE\_QZSS\_L2C\_L** QZSS L2C\_L RF Band.  
**GNSS\_DATA\_SIGNAL\_TYPE\_QZSS\_L5\_Q** QZSS L5\_Q RF Band.  
**GNSS\_DATA\_SIGNAL\_TYPE\_SBAS\_L1\_CA** SBAS L1\_CA RF Band.  
**GNSS\_DATA\_SIGNAL\_TYPE\_NAVIC\_L5** NAVIC L5 RF Band.  
**GNSS\_DATA\_SIGNAL\_TYPE\_BEIDOU\_B2A\_Q** BEIDOU B2A\_Q RF Band. Maximum number of signal types.  
**GNSS\_DATA\_MAX\_NUMBER\_OF\_SIGNAL\_TYPES**

#### 4.18.2.22 enum telux::loc::GnssDataValidityType

Specify valid mask of data fields in [GnssData](#).

**Enumerator**

**HAS\_JAMMER** Jammer Indicator is available

**HAS\_AGC** AGC is available

**4.18.2.23 enum telux::loc::DrCalibrationStatusType**

Specify the sensor calibration status in [ILocationInfoEx](#).

**Enumerator**

**DR\_ROLL\_CALIBRATION\_NEEDED** Indicate that roll calibration is needed. Need to take more turns on level ground.

**DR\_PITCH\_CALIBRATION\_NEEDED** Indicate that pitch calibration is needed. Need to take more turns on level ground.

**DR\_YAW\_CALIBRATION\_NEEDED** Indicate that yaw calibration is needed. Need to accelerate in a straight line.

**DR\_ODO\_CALIBRATION\_NEEDED** Indicate that odo calibration is needed. Need to accelerate in a straight line.

**DR\_GYRO\_CALIBRATION\_NEEDED** Indicate that gyro calibration is needed. Need to take more turns on level ground.

**DR\_TURN\_CALIBRATION\_LOW** Lot more turns on level ground needed

**DR\_TURN\_CALIBRATION\_MEDIUM** Some more turns on level ground needed

**DR\_TURN\_CALIBRATION\_HIGH** Sufficient turns on level ground observed

**DR\_LINEAR\_ACCEL\_CALIBRATION\_LOW** Lot more accelerations in straight line needed

**DR\_LINEAR\_ACCEL\_CALIBRATION\_MEDIUM** Some more accelerations in straight line needed

**DR\_LINEAR\_ACCEL\_CALIBRATION\_HIGH** Sufficient acceleration events in straight line observed

**DR\_LINEAR\_MOTION\_CALIBRATION\_LOW** Lot more motion in straight line needed

**DR\_LINEAR\_MOTION\_CALIBRATION\_MEDIUM** Some more motion in straight line needed

**DR\_LINEAR\_MOTION\_CALIBRATION\_HIGH** Sufficient motion events in straight line observed

**DR\_STATIC\_CALIBRATION\_LOW** Lot more stationary events on level ground needed

**DR\_STATIC\_CALIBRATION\_MEDIUM** Some more stationary events on level ground needed

**DR\_STATIC\_CALIBRATION\_HIGH** Sufficient stationary events on level ground observed

**4.18.2.24 enum telux::loc::DrSolutionStatusType**

Specify various status that contributes to the DR position engine.

**Enumerator**

**VEHICLE\_SENSOR\_SPEED\_INPUT\_DETECTED** Vehicle sensor speed input was detected by the DR position engine.

**VEHICLE\_SENSOR\_SPEED\_INPUT\_USED** Vehicle sensor speed input was used by the DR position engine.

**WARNING\_UNCALIBRATED** DRE solution disengaged due to insufficient calibration

**WARNING\_GNSS\_QUALITY\_INSUFFICIENT** DRE solution disengaged due to bad GNSS quality

**WARNING\_FERRY\_DETECTED** DRE solution disengaged as ferry condition detected

**ERROR\_6DOF\_SENSOR\_UNAVAILABLE** DRE solution disengaged as 6DOF sensor inputs not available

**ERROR\_VEHICLE\_SPEED\_UNAVAILABLE** DRE solution disengaged as vehicle speed inputs not available



**ERROR\_GNSS\_EPH\_UNAVAILABLE** DRE solution disengaged as Ephemeris info not available

**ERROR\_GNSS\_MEAS\_UNAVAILABLE** DRE solution disengaged as GNSS measurement info not available

**WARNING\_INIT\_POSITION\_INVALID** DRE solution disengaged due non-availability of stored position from previous session

**WARNING\_INIT\_POSITION\_UNRELIABLE** DRE solution dis-engaged due to vehicle motion detected at session start

**WARNING\_POSITON\_UNRELIABLE** DRE solution dis-engaged due to unreliable position

**ERROR\_GENERIC** DRE solution dis-engaged due to a generic error

**WARNING\_SENSOR\_TEMP\_OUT\_OF\_RANGE** DRE solution dis-engaged due to Sensor Temperature being out of range

**WARNING\_USER\_DYNAMICS\_INSUFFICIENT** DRE solution dis-engaged due to insufficient user dynamics

**WARNING\_FACTORY\_DATA\_INCONSISTENT** DRE solution dis-engaged due to inconsistent factory data

#### 4.18.2.25 enum telux::loc::LocReqEngineType

Specifies the set of engines whose position reports are requested via startDetailedEngineReports.

##### Enumerator

**LOC\_REQ\_ENGINE\_FUSED\_BIT** Indicate that the fused/default position is needed to be reported back for the tracking sessions. The default position is the propagated/aggregated reports from all engines running on the system (e.g.: DR/SPE/PPE) according to QTI algorithm.

**LOC\_REQ\_ENGINE\_SPE\_BIT** Indicate that the unmodified SPE position is needed to be reported back for the tracking sessions.

**LOC\_REQ\_ENGINE\_PPE\_BIT** Indicate that the unmodified PPE position is needed to be reported back for the tracking sessions.

**LOC\_REQ\_ENGINE\_VPE\_BIT** Indicate that the unmodified VPE position is needed to be reported back for the tracking sessions.

#### 4.18.2.26 enum telux::loc::LocationAggregationType

Specifies the type of engine for the reported fixes

##### Enumerator

**LOC\_OUTPUT\_ENGINE\_FUSED** This is the propagated/aggregated report from the fixes of all engines running on the system (e.g.: DR/SPE/PPE).

**LOC\_OUTPUT\_ENGINE\_SPE** This fix is the unmodified fix from modem GNSS engine

**LOC\_OUTPUT\_ENGINE\_PPE** This is the unmodified fix from PPP engine

**LOC\_OUTPUT\_ENGINE\_VPE** This is the unmodified fix from VPE engine.

#### 4.18.2.27 enum telux::loc::PositioningEngineType

Specifies the type of engine responsible for fixes when the engine type is fused

##### Enumerator

**STANDARD\_POSITIONING\_ENGINE** For standard GNSS position engines.

**DEAD\_RECKONING\_ENGINE** For dead reckoning position engines.

**PRECISE\_POSITIONING\_ENGINE** For precise position engines.

**VP\_POSITIONING\_ENGINE** For VP position engine.

#### 4.18.2.28 enum telux::loc::LeverArmType

Lever ARM type

##### Enumerator

**LEVER\_ARM\_TYPE\_GNSS\_TO\_VRP** Lever arm parameters regarding the VRP (Vehicle Reference Point) w.r.t the origin (at the GNSS Antenna)

**LEVER\_ARM\_TYPE\_DR\_IMU\_TO\_GNSS** Lever arm regarding GNSS Antenna w.r.t the origin at the IMU (inertial measurement unit) for DR (dead reckoning engine)

**LEVER\_ARM\_TYPE\_VEPP\_IMU\_TO\_GNSS** Lever arm regarding GNSS Antenna w.r.t the origin at the IMU (inertial measurement unit) for VEPP (vision enhanced precise positioning engine)

##### Deprecated

enum type is not supported.

**LEVER\_ARM\_TYPE\_VPE\_IMU\_TO\_GNSS** Lever arm regarding GNSS Antenna w.r.t the origin at the IMU (inertial measurement unit) for VPE (vision positioning engine)

#### 4.18.2.29 enum telux::loc::GnssMeasurementsDataValidityType

Specify valid fields in [GnssMeasurementsData](#).

##### Enumerator

**SV\_ID\_BIT** Validity of svId.

**SV\_TYPE\_BIT** Validity of svType.

**STATE\_BIT** Validity of stateMask.

**RECEIVED\_SV\_TIME\_BIT** Validity of receivedSvTimeNs and receivedSvTimeSubNs.

**RECEIVED\_SV\_TIME\_UNCERTAINTY\_BIT** Validity of receivedSvTimeUncertaintyNs.

**CARRIER\_TO\_NOISE\_BIT** Validity of carrierToNoiseDbHz.

**PSEUDORANGE\_RATE\_BIT** Validity of pseudorangeRateMps.

**PSEUDORANGE\_RATE\_UNCERTAINTY\_BIT** Validity of pseudorangeRateUncertaintyMps.

**ADR\_STATE\_BIT** Validity of adrStateMask.

**ADR\_BIT** Validity of adrMeters.

**ADR\_UNCERTAINTY\_BIT** Validity of adrUncertaintyMeters.

**CARRIER\_FREQUENCY\_BIT** Validity of carrierFrequencyHz.

**CARRIER\_CYCLES\_BIT** Validity of carrierCycles.

**CARRIER\_PHASE\_BIT** Validity of carrierPhase.

**CARRIER\_PHASE\_UNCERTAINTY\_BIT** Validity of carrierPhaseUncertainty.

**MULTIPATH\_INDICATOR\_BIT** Validity of multipathIndicator.

**SIGNAL\_TO\_NOISE\_RATIO\_BIT** Validity of signalToNoiseRatioDb.

**AUTOMATIC\_GAIN\_CONTROL\_BIT** Validity of agcLevelDb.

**GNSS\_SIGNAL\_TYPE** Validity of signal type.

**BASEBAND\_CARRIER\_TO\_NOISE** Validity of basebandCarrierToNoise.

**FULL\_ISB** Validity of fullInterSignalBias.

**FULL\_ISB\_UNCERTAINTY** Validity of fullInterSignalBiasUncertainty.

#### 4.18.2.30 enum telux::loc::GnssMeasurementsStateValidityType

Specify GNSS measurement state in [GnssMeasurementsData::stateMask](#).

##### Enumerator

**UNKNOWN\_BIT** State is unknown.

**CODE\_LOCK\_BIT** State is "code lock".

**BIT\_SYNC\_BIT** State is "bit sync".

**SUBFRAME\_SYNC\_BIT** State is "subframe sync".

**TOW\_DECODED\_BIT** State is "tow decoded".

**MSEC\_AMBIGUOUS\_BIT** State is "msec ambiguous".

**SYMBOL\_SYNC\_BIT** State is "symbol sync".

**GLO\_STRING\_SYNC\_BIT** State is "GLONASS string sync".

**GLO\_TOD\_DECODED\_BIT** State is "GLONASS TOD decoded".

**BDS\_D2\_BIT\_SYNC\_BIT** State is "BDS D2 bit sync".

**BDS\_D2\_SUBFRAME\_SYNC\_BIT** State is "BDS D2 subframe sync".

**GAL\_E1BC\_CODE\_LOCK\_BIT** State is "Galileo E1BC code lock".

**GAL\_E1C\_2ND\_CODE\_LOCK\_BIT** State is "Galileo E1C second code lock".

**GAL\_E1B\_PAGE\_SYNC\_BIT** State is "Galileo E1B page sync".

**SBAS\_SYNC\_BIT** State is "SBAS sync".

#### 4.18.2.31 enum telux::loc::GnssMeasurementsAdrStateValidityType

Specify accumulated delta range state in [GnssMeasurementsData::adrStateMask](#).

##### Enumerator

**UNKNOWN\_STATE** State is unknown.

**VALID\_BIT** State is valid.

**RESET\_BIT** State is "reset".

**CYCLE\_SLIP\_BIT** State is "cycle slip".

#### 4.18.2.32 enum telux::loc::GnssMeasurementsMultipathIndicator

Specify the GNSS multipath indicator state in [GnssMeasurementsData::multipathIndicator](#).

##### Enumerator

**UNKNOWN\_INDICATOR** Multipath indicator is unknown.

**PRESENT** Multipath indicator is present.

**NOT\_PRESENT** Multipath indicator is not present.

#### 4.18.2.33 enum telux::loc::GnssMeasurementsClockValidityType

Specify the valid fields in [GnssMeasurementsClock](#).

**Enumerator**

**LEAP\_SECOND\_BIT** Validity of leapSecond.  
**TIME\_BIT** Validity of timeNs.  
**TIME\_UNCERTAINTY\_BIT** Validity of timeUncertaintyNs.  
**FULL\_BIAS\_BIT** Validity of fullBiasNs.  
**BIAS\_BIT** Validity of biasNs.  
**BIAS\_UNCERTAINTY\_BIT** Validity of biasUncertaintyNs.  
**DRIFT\_BIT** Validity of driftNsps.  
**DRIFT\_UNCERTAINTY\_BIT** Validity of driftUncertaintyNsps.  
**HW\_CLOCK\_DISCONTINUITY\_COUNT\_BIT** Validity of hwClockDiscontinuityCount.

**4.18.2.34 enum telux::loc::GnssReportDCType**

Disaster and crisis report types that are currently supported by the GNSS Engine.

**Enumerator**

**QZSS\_JMA\_DISASTER\_PREVENTION\_INFO** Disaster Prevention information provided by Japan Meteorological Agency.  
**QZSS\_NON\_JMA\_DISASTER\_PREVENTION\_INFO** Disaster Prevention information provided by other organizations.

**4.18.2.35 enum telux::loc::LeapSecondInfoValidityType**

Specify the valid fields in [LeapSecondInfo](#).

**Enumerator**

**LEAP\_SECOND\_SYS\_INFO\_CURRENT\_LEAP\_SECONDS\_BIT** Validity of [LeapSecondInfo::current](#).  
**LEAP\_SECOND\_SYS\_INFO\_LEAP\_SECOND\_CHANGE\_BIT** Validity of [LeapSecondInfo::info](#).

**4.18.2.36 enum telux::loc::LocationSystemInfoValidityType**

Specify the set of valid fields in [LocationSystemInfo](#)

**Enumerator**

**LOCATION\_SYS\_INFO\_LEAP\_SECOND** contains current leap second or leap second change info

**4.18.2.37 enum telux::loc::GnssEnergyConsumedInfoValidityType**

Specify the valid fields in [GnssEnergyConsumedInfo](#).

**Enumerator**

**ENERGY\_CONSUMED\_SINCE\_FIRST\_BOOT\_BIT** validity of [GnssEnergyConsumedInfo](#)

#### 4.18.2.38 enum telux::loc::AidingDataType

Specifies the set of aiding data. This is referenced in the deleteAidingData for deleting any aiding data.

##### Enumerator

**AIDING\_DATA\_EPHEMERIS** Mask to delete ephemeris aiding data

**AIDING\_DATA\_DR\_SENSOR\_CALIBRATION** Mask to delete calibration data from dead reckoning position engine

#### 4.18.2.39 enum telux::loc::TerrestrialTechnologyType

Specifies the set of terrestrial technologies.

##### Enumerator

**GTP\_WWAN** Cell-based technology

#### 4.18.2.40 enum telux::loc::NmeaSentenceType

Specifies the HLOS generated NMEA sentence types.

##### Enumerator

**GGA** GGA NMEA sentence

**RMC** RMC NMEA sentence

**GSA** GSA NMEA sentence

**VTG** VTG NMEA sentence

**GNS** GNS NMEA sentence

**DTM** DTM NMEA sentence

**GPGSV** GPGSV NMEA sentence for SVs from GPS constellation

**GLGSV** GLGSV NMEA sentence for SVs from GLONASS constellation

**GAGSV** GAGSV NMEA sentence for SVs from GALILEO constellation

**GQGSV** GQGSV NMEA sentence for SVs from QZSS constellation

**GBGSV** GBGSV NMEA sentence for SVs from BEIDOU constellation

**GIGSV** GIGSV NMEA sentence for SVs from NAVIC constellation

**ALL** All NMEA sentences

#### 4.18.2.41 enum telux::loc::GeodeticDatumType [strong]

Specify the Geodetic datum for NMEA sentence types that are generated.

##### Enumerator

**GEODETIC\_TYPE\_NONE** No type

**GEODETIC\_TYPE\_WGS\_84** Geodetic datum type to indicate the use of World Geodetic System 1984 (WGS84) system

**GEODETIC\_TYPE\_PZ\_90** Geodetic datum type to indicate the use of PZ90/GLONASS system

#### 4.18.2.42 enum telux::loc::RobustLocationConfigType

Specify the valid mask for robust location configuration used by the GNSS standard position engine (SPE).

##### Enumerator

**VALID\_ENABLED** Validity of enabled  
**VALID\_ENABLED\_FOR\_E911** Validity of enabledForE911.  
**VALID\_VERSION** Validity of version.

#### 4.18.2.43 enum telux::loc::DRConfigValidityType

Specify the valid mask for the configuration parameters of dead reckoning position engine

##### Enumerator

**BODY\_TO\_SENSOR\_MOUNT\_PARAMS\_VALID** Validity of body to sensor mount parameters.  
**VEHICLE\_SPEED\_SCALE\_FACTOR\_VALID** Validity of vehicle speed scale factor.  
**VEHICLE\_SPEED\_SCALE\_FACTOR\_UNC\_VALID** Validity of vehicle speed scale factor uncertainty.  
**GYRO\_SCALE\_FACTOR\_VALID** Validity of gyro scale factor.  
**GYRO\_SCALE\_FACTOR\_UNC\_VALID** Validity of gyro scale factor uncertainty.

#### 4.18.2.44 enum telux::loc::GnssReportType

Specifies the set of gnss reports.

##### Enumerator

**LOCATION** Location reports  
**SATELLITE\_VEHICLE** Satellite reports  
**NMEA** To receive updates via [ILocationListener::onGnssNmeaInfo](#), clients need to set this bit in the reportMask parameter passed to [ILocationManager::startDetailedReports](#) and [ILocationManager::startDetailedEngineReports](#).  
 Clients should set NMEA if they only need sentences from FUSED engine Or set ENGINE NMEA if they need sentences from specific engine types. Clients should never set both.  
 Also refer to [ILocationManager::startDetailedEngineReports](#) to understand the usage further.  
**DATA** Data reports  
**MEASUREMENT** Low rate measurement reports. Currently the rate is defined to be 1 Hz.  
**HIGH\_RATE\_MEASUREMENT** High rate measurement reports. Currently the rate is defined to be 10 Hz. Client cannot specify rates. The data in high rate would be different that from low rate. Also there might be difference in accuracy of fields for the both the rates.  
**DISASTER\_CRISIS**  
**ENGINE\_NMEA** To receive updates via [ILocationListener::onEngineNmeaInfo](#), clients need to set this bit in the reportMask parameter passed to [ILocationManager::startDetailedEngineReports](#).  
 Clients should set NMEA if they only need sentences from FUSED engine Or set ENGINE NMEA if they need sentences from specific engine types. Clients should never set both.  
 Also refer to [ILocationManager::startDetailedEngineReports](#) to understand the usage further.

#### 4.18.2.45 enum telux::loc::EngineType [strong]

Specify the position engine types

##### Enumerator

- UNKNOWN** Unknown engine type.
- SPE** Standard GNSS position engine.
- PPE** Precise position engine.
- DRE** Dead reckoning position engine.
- VPE** Vision positioning engine.

#### 4.18.2.46 enum telux::loc::LocationEngineRunState [strong]

Specify the position engine run state

##### Enumerator

- UNKNOWN** Unknown engine run state.
- SUSPENDED** Request the position engine to be put into suspended state. When put in this state the QDR engine will discard calibration data.
- RUNNING** Request the position engine to be put into running state.
- SUSPEND\_RETAIN** Request the position engine to be put into suspend state while retaining any calibration data. While configuring this engine state via [ILocationConfigurator::configure↔EngineState](#), the vehicle is expected to be stationary and should be set to **RUNNING** before the vehicle is expected to move (for example, on Ignition On). This state is applicable when the client expects QDR to retain necessary data for subsequent resume/reboot while being suspended.

#### 4.18.2.47 enum telux::loc::ReportStatus [strong]

Specify the status of the report

##### Enumerator

- UNKNOWN** Report status is unknown.
- SUCCESS** Report status is successful. The engine is able to calculate the desired fix. Most of the fields in [ILocationInfoEx](#) will be valid.
- INTERMEDIATE** Report is still in progress. The engine has not completed its calculations when this report was generated. Accuracy of various fields is non-optimal. Only some of the fields in [ILocationInfoEx](#) will be valid.
- FAILURE** Report status has failed. The engine is not able to calculate the fix. Most of the fields in [ILocationInfoEx](#) will be invalid.

#### 4.18.2.48 enum telux::loc::DebugLogLevel [strong]

Specify the logcat debug level during XTRA's param configuration. Currently, only XTRA daemon will support the runtime configuration of the debug log level.

**Enumerator**

**DEBUG\_LOG\_LEVEL\_NONE** No message is logged.

**DEBUG\_LOG\_LEVEL\_ERROR** Only error level debug messages will get logged.

**DEBUG\_LOG\_LEVEL\_WARNING** Only warning and error level debug messages will get logged.

**DEBUG\_LOG\_LEVEL\_INFO** Only info, warning and error level debug messages will get logged.

**DEBUG\_LOG\_LEVEL\_DEBUG** Only debug, info, warning and error level debug messages will get logged.

**DEBUG\_LOG\_LEVEL\_VERBOSE** Verbose, debug, info, warning and error level debug messages will get logged.

**4.18.2.49 enum telux::loc::XtraDataStatus [strong]**

Provides the status of the previously downloaded Xtra data.

**Enumerator**

**STATUS\_UNKNOWN** If XTRA feature is disabled or if XTRA feature is enabled, but XTRA daemon has not yet retrieved the assistance data status from modem on early stage of device bootup, xtra data status will be unknown.

**STATUS\_NOT\_AVAIL** If XTRA feature is enabled, but XTRA data is not present on the device.

**STATUS\_NOT\_VALID** If XTRA feature is enabled, XTRA data has been downloaded ever but no longer valid.

**STATUS\_VALID** If XTRA feature is enabled, XTRA data has been downloaded and is currently valid.

**4.18.2.50 enum telux::loc::LocConfigIndicationsType**

Enum of all the possible indications invoked by a Location Configurator listener.

**Enumerator**

**LOC\_CONF\_IND\_XTRA\_STATUS** Register to receive Xtra status updates. Register to receive Gnss signal updates.

**LOC\_CONF\_IND\_SIGNAL\_UPDATE**

**4.18.3 Variable Documentation**

**4.18.3.1 const float telux::loc::UNKNOWN\_CARRIER\_FREQ = -1**

**4.18.3.2 const int telux::loc::UNKNOWN\_SIGNAL\_MASK = 0**

**4.18.3.3 const double telux::loc::UNKNOWN\_BASEBAND\_CARRIER\_NOISE = 0.0**

**4.18.3.4 const uint64\_t telux::loc::UNKNOWN\_TIMESTAMP = 0**

**4.18.3.5 const float telux::loc::DEFAULT\_TUNC\_THRESHOLD = 0.0**

Default value for threshold of time uncertainty. Units: milli-seconds.



**4.18.3.6 const int telux::loc::DEFAULT\_TUNC\_ENERGY\_THRESHOLD = 0**

Default value for energy consumed of time uncertainty. The default here means that the engine is allowed to use infinite power. Units: 100 micro watt second.

**4.18.3.7 const uint64\_t telux::loc::INVALID\_ENERGY\_CONSUMED = 0xffffffffffffff**

0xffffffffffffff indicates an invalid reading for energy consumed info.

**4.18.3.8 const float telux::loc::UNKNOWN\_SV\_TIME\_SUB\_NS = -1**

Unknown Sub nanoseconds portion of the received GNSS time.

**4.18.3.9 const uint32\_t telux::loc::DEFAULT\_GNSS\_REPORT = (0xffffffff ^ ENGINE\_NMEA)**

## 4.19 Common

This section contains APIs related to Logger, Command Callbacks, Error Codes and [Version](#) information. Also contains Macros to print message at different log level.

### 4.19.1 Data Structure Documentation

#### 4.19.1.1 class telux::common::ICommandCallback

Base command callback class is responsible for single shot asynchronous callback. This callback will be invoked only once when the operation succeeds or fails.

##### Public member functions

- virtual [~ICommandCallback](#) ()

##### 4.19.1.1.1 Constructors and Destructors

4.19.1.1.1 virtual telux::common::ICommandCallback::~ICommandCallback ( ) [virtual]

#### 4.19.1.2 class telux::common::ICommandResponseCallback

General command response callback for most of the requests, client needs to implement this interface to get single shot response.

The methods in callback can be invoked from multiple different threads. The implementation should be thread safe.

##### Public member functions

- virtual void [commandResponse](#) (ErrorCode error)=0
- virtual [~ICommandResponseCallback](#) ()

##### 4.19.1.2.1 Constructors and Destructors

4.19.1.2.1 virtual telux::common::ICommandResponseCallback::~ICommandResponseCallback ( ) [virtual]

##### 4.19.1.2.2 Member Function Documentation

4.19.1.2.2.1 virtual void telux::common::ICommandResponseCallback::commandResponse ( ErrorCode *error* ) [pure virtual]

This function is called with the response to the command operation.

##### Parameters

in	<i>error</i>	- <a href="#">ErrorCode</a>
----	--------------	-----------------------------

### 4.19.1.3 class telux::common::DeviceConfig

#### Static Public Member Functions

- static bool [isMultiSimSupported](#) ()

#### 4.19.1.3.1 Member Function Documentation

##### 4.19.1.3.1.1 static bool telux::common::DeviceConfig::isMultiSimSupported ( ) [static]

Check whether multi SIM support available.

#### Returns

bool to determine multi SIM support

### 4.19.1.4 class telux::common::Log

#### Static Public Member Functions

- template<typename... MessageArgs>  
static void [logMessage](#) ([LogLevel](#) logLevel, const std::string &fileName, const std::string &lineNo, const int &component, MessageArgs...params)
- static void [logStream](#) (std::ostringstream &outputStream, [LogLevel](#) logLevel, const std::string &fileName, const std::string &lineNo, const int &component)

#### 4.19.1.4.1 Member Function Documentation

##### 4.19.1.4.1.1 template<typename... MessageArgs> static void telux::common::Log::logMessage ( [LogLevel](#) *logLevel*, const std::string & *fileName*, const std::string & *lineNo*, const int & *component*, MessageArgs... *params* ) [static]

Public API to log a message

#### Parameters

in	<i>logLevel</i>	Log level <a href="#">LogLevel</a>
in	<i>fileName</i>	File name from where log is getting printed
in	<i>lineNo</i>	Line number from where log is getting printed
in	<i>component</i>	Identifier, as listed in SDK configuration
in	<i>params</i>	Additional parameters to be logged

##### 4.19.1.4.1.2 static void telux::common::Log::logStream ( std::ostringstream & *outputStream*, [LogLevel](#) *logLevel*, const std::string & *fileName*, const std::string & *lineNo*, const int & *component* ) [static]

Public API to log a string stream

**Parameters**

in	<i>outputStream</i>	String stream which will be logged
in	<i>logLevel</i>	Log level <a href="#">LogLevel</a>
in	<i>fileName</i>	File name from where log is getting printed
in	<i>lineNo</i>	Line number from where log is getting printed
in	<i>component</i>	Identifier, as listed in SDK configuration

**4.19.1.5 struct telux::common::SdkVersion**

Structure of major, minor and patch version

**Data fields**

Type	Field	Description
int	major	Major <a href="#">Version</a> : This number will be incremented whenever significant changes or features are introduced
int	minor	Minor <a href="#">Version</a> : This number will be incremented when smaller features with some new APIs are introduced.
int	patch	Patch <a href="#">Version</a> : If the release only contains bug fixes, but no API change then the patch version would be incremented.

**4.19.1.6 class telux::common::Version**

Provides version of SDK.

**Static Public Member Functions**

- static std::string [getReleaseName](#) ()
- static [SdkVersion](#) [getSdkVersion](#) ()

**4.19.1.6.1 Member Function Documentation****4.19.1.6.1.1 static std::string telux::common::Version::getReleaseName ( ) [static]**

Get the release name.

**Returns**

String contains release name

**4.19.1.6.1.2 static SdkVersion telux::common::Version::getSdkVersion ( ) [static]**

Get the Telematics SDK version, for example: 01.00.00

**Returns**

[SdkVersion](#) structure of major, minor and patch version

## 4.19.2 Enumeration Type Documentation

### 4.19.2.1 enum telux::common::Status [strong]

Defines all the status codes that all Telematics SDK APIs can return

#### Enumerator

**SUCCESS** API processing is successful, returned parameters are valid  
**FAILED** API processing failure.  
**NOCONNECTION** Connection to Socket server has not been established  
**NOSUBSCRIPTION** Subscription not available  
**INVALIDPARAM** Input parameters are invalid  
**INVALIDSTATE** Invalid State  
**NOTREADY** Subsystem is not ready  
**NOTALLOWED** Operation not allowed  
**NOTIMPLEMENTED** Functionality not implemented  
**CONNECTIONLOST** Connection to Socket server lost  
**EXPIRED** Expired  
**ALREADY** Already registered handler  
**NOSUCH** No such object  
**NOTSUPPORTED** Not supported on target platform  
**NOMEMORY** Not sufficient memory to process the request  
**ACCESSDENIED** Permission denied

### 4.19.2.2 enum telux::common::ErrorCode [strong]

Generic Error code for each API responses

#### Enumerator

**SUCCESS** No error  
**RADIO\_NOT\_AVAILABLE** If radio did not start or is resetting  
**GENERIC\_FAILURE** Generic Failure  
**PASSWORD\_INCORRECT** For PIN/PIN2 methods only  
**SIM\_PIN2** Operation requires SIM PIN2 to be entered  
**SIM\_PUK2** Operation requires SIM PIN2 to be entered  
**REQUEST\_NOT\_SUPPORTED** Not Supported request  
**CANCELLED** Cancelled  
**OP\_NOT\_ALLOWED\_DURING\_VOICE\_CALL** Data operation are not allowed during voice call on a Class C GPRS device  
**OP\_NOT\_ALLOWED\_BEFORE\_REG\_TO\_NW** Data operation are not allowed before device registers in network  
**SMS\_SEND\_FAIL\_RETRY** Fail to send SMS and need retry  
**SIM\_ABSENT** Fail to set the location where CDMA subscription shall be retrieved because of SIM or RUIM are absent  
**SUBSCRIPTION\_NOT\_AVAILABLE** Fail to find CDMA subscription from specified location  
**MODE\_NOT\_SUPPORTED** Hardware does not support preferred network type  
**FDN\_CHECK\_FAILURE** Command failed because recipient is not on FDN list  
**ILLEGAL\_SIM\_OR\_ME** Network selection failed due to illegal SIM or ME  
**MISSING\_RESOURCE** No logical channel available

**NO\_SUCH\_ELEMENT** Application not found on SIM

**DIAL\_MODIFIED\_TO\_USSD** DIAL request modified to USSD

**DIAL\_MODIFIED\_TO\_SS** DIAL request modified to SS

**DIAL\_MODIFIED\_TO\_DIAL** DIAL request modified to DIAL with different data

**USSD\_MODIFIED\_TO\_DIAL** USSD request modified to DIAL

**USSD\_MODIFIED\_TO\_SS** USSD request modified to SS

**USSD\_MODIFIED\_TO\_USSD** USSD request modified to different USSD request

**SS\_MODIFIED\_TO\_DIAL** SS request modified to DIAL

**SS\_MODIFIED\_TO\_USSD** SS request modified to USSD

**SUBSCRIPTION\_NOT\_SUPPORTED** Subscription not supported

**SS\_MODIFIED\_TO\_SS** SS request modified to different SS request

**LCE\_NOT\_SUPPORTED** LCE service not supported

**NO\_MEMORY** Not sufficient memory to process the request

**INTERNAL\_ERR** Hit unexpected vendor internal error scenario

**SYSTEM\_ERR** Hit platform or system error

**MODEM\_ERR** Hit unexpected modem error

**INVALID\_STATE** Unexpected request for the current state

**NO\_RESOURCES** Not sufficient resource to process the request

**SIM\_ERR** Received error from SIM card

**INVALID\_ARGUMENTS** Received invalid arguments in request

**INVALID\_SIM\_STATE** Cannot process the request in current SIM state

**INVALID\_MODEM\_STATE** Cannot process the request in current Modem state

**INVALID\_CALL\_ID** Received invalid call id in request

**NO\_SMS\_TO\_ACK** ACK received when there is no SMS to ack

**NETWORK\_ERR** Received error from network

**REQUEST\_RATE\_LIMITED** Operation denied due to overly-frequent requests

**SIM\_BUSY** SIM is busy

**SIM\_FULL** The target EF is full

**NETWORK\_REJECT** Request is rejected by network

**OPERATION\_NOT\_ALLOWED** Not allowed the request now

**EMPTY\_RECORD** The request record is empty

**INVALID\_SMS\_FORMAT** Invalid SMS format

**ENCODING\_ERR** Message not encoded properly

**INVALID\_SMSC\_ADDRESS** SMSC address specified is invalid

**NO\_SUCH\_ENTRY** No such entry present to perform the request

**NETWORK\_NOT\_READY** Network is not ready to perform the request

**NOT\_PROVISIONED** Device does not have this value provisioned

**NO\_SUBSCRIPTION** Device does not have subscription

**NO\_NETWORK\_FOUND** Network cannot be found

**DEVICE\_IN\_USE** Operation cannot be performed because the device is currently in use

**ABORTED** Operation aborted

**INCOMPATIBLE\_STATE** Operation cannot be performed because the device is in incompatible state

**NO\_EFFECT** Given request had to no effect

**DEVICE\_NOT\_READY** Device not ready

**MISSING\_ARGUMENTS** Missing one or more arguments

**FILE\_NOT\_FOUND** Required configuration file is missing

**PIN\_PERM\_BLOCKED** PIN is permanently blocked. The SIM is unusable.

**PIN\_BLOCKED** PIN is blocked. Unblock operation must be issued.

**MALFORMED\_MSG** Message was not formulated correctly by the control point or the message was corrupted during transmission

**INTERNAL** Internal error

**CLIENT\_IDS\_EXHAUSTED** Client IDs exhausted

**UNABORTABLE\_TRANSACTION** The specified transaction could not be aborted

**INVALID\_CLIENT\_ID** Could not find client's request

**NO\_THRESHOLDS** No thresholds specified in enable signal strength

**INVALID\_HANDLE** Invalid client handle was received

**INVALID\_PROFILE** Invalid profile index specified

**INVALID\_PINID** PIN in the request is invalid.

**INCORRECT\_PIN** PIN in the request is incorrect.

**CALL\_FAILED** Call origination failed in the lower layers

**OUT\_OF\_CALL** Request issued when packet data session disconnected

**MISSING\_ARG** TLV was missing in the request.

**ARG\_TOO\_LONG** Path in the request was too long.

**INVALID\_TX\_ID** The transaction ID supplied in the request does not match any pending transaction  
i.e. either the transaction was not received or it is already executed by the device

**OP\_NETWORK\_UNSUPPORTED** Selected operation is not supported by the network

**OP\_DEVICE\_UNSUPPORTED** Operation is not supported by device or SIM card

**NO\_FREE\_PROFILE** Maximum number of profiles are stored in the device and there is no more storage available to create a new profile

**INVALID\_PDP\_TYPE** PDP type specified is not supported

**INVALID\_TECH\_PREF** Invalid technology preference

**INVALID\_PROFILE\_TYPE** Invalid profile type is specified

**INVALID\_SERVICE\_TYPE** Invalid service type

**INVALID\_REGISTER\_ACTION** Invalid register action value specified in request

**INVALID\_PS\_ATTACH\_ACTION** Invalid PS attach action value specified in request

**AUTHENTICATION\_FAILED** Authentication error.

**SIM\_NOT\_INITIALIZED** PIN is not yet initialized because the SIM initialization has not finished. Try the PIN operation later.

**MAX\_QOS\_REQUESTS\_IN\_USE** Maximum QoS requests in use

**INCORRECT\_FLOW\_FILTER** Incorrect flow filter

**NETWORK\_QOS\_UNAWARE** Network QoS unaware

**INVALID\_ID** Invalid call ID was sent in the request

**REQUESTED\_NUM\_UNSUPPORTED** Requested message ID is not supported by the currently running software

**INTERFACE\_NOT\_FOUND** Cannot retrieve the FMC interface

**FLOW\_SUSPENDED** Flow suspended

**INVALID\_DATA\_FORMAT** Invalid data format

**GENERAL** General error

**UNKNOWN** Unknown error

**INVALID\_ARG** Parameters passed as input were invalid

**INVALID\_INDEX** MIP profile index is not within the valid range

**NO\_ENTRY** No message exists at the specified memory storage designation

**DEVICE\_STORAGE\_FULL** Memory storage specified in the request is full

**CAUSE\_CODE** There was an error in the request

**MESSAGE\_NOT\_SENT** Message could not be sent

**MESSAGE\_DELIVERY\_FAILURE** Message could not be delivered

**INVALID\_MESSAGE\_ID** Message ID specified for the message is invalid

**ENCODING** Message is not encoded properly

**AUTHENTICATION\_LOCK** Maximum number of authentication failures has been reached

**INVALID\_TRANSITION** Selected operating mode transition from the current operating mode is invalid

**NOT\_A\_MCAST\_IFACE** Not a MCAST interface

**MAX\_MCAST\_REQUESTS\_IN\_USE** MCAST request in use

**INVALID\_MCAST\_HANDLE** An invalid MCAST handle

**INVALID\_IP\_FAMILY\_PREF** IP family preference is invalid

**SESSION\_INACTIVE** Session inactive

**SESSION\_INVALID** Session not valid

**SESSION\_OWNERSHIP** Session ownership error

**INSUFFICIENT\_RESOURCES** Response is longer than the maximum supported size

**DISABLED** Disabled

**INVALID\_OPERATION** Device is not expecting the request.

**INVALID\_QMI\_CMD** Invalid QMI command

**TPDU\_TYPE** Message in memory contains a TPDU type that cannot be read

**SMSC\_ADDR** SMSC address specified is invalid

**INFO\_UNAVAILABLE** Information is not available

**SEGMENT\_TOO\_LONG** PRL segment size is too large

**SEGMENT\_ORDER** PRL segment order is incorrect

**BUNDLING\_NOT\_SUPPORTED** Bundling not supported

**OP\_PARTIAL\_FAILURE** Some personalization codes were set but an error prevented

**POLICY\_MISMATCH** Network policy does not match a valid NAT

**SIM\_FILE\_NOT\_FOUND** File is not present on the card.

**EXTENDED\_INTERNAL** Error from the the DS profile module, the extended error

**ACCESS\_DENIED** Access to the requested file is denied. This can occur when there is an attempt to access a PIN-protected file.

**HARDWARE\_RESTRICTED** Selected operating mode is invalid with the current wireless disable setting

**ACK\_NOT\_SENT** ACK could not be sent

**INJECT\_TIMEOUT** Inject timeout

**FDN\_RESTRICT** FDN restriction

**SUPS\_FAILURE\_CAUSE** Indicates supplementary services failure information;

**NO\_RADIO** Radio is not available

**NOT\_SUPPORTED** Operation is not supported

**CARD\_CALL\_CONTROL\_FAILED** SIM/R-UIM call control failed

**NETWORK\_ABORTED** Operation was released abruptly by the network

**MSG\_BLOCKED** Message blocked

**INVALID\_SESSION\_TYPE** Invalid session type

**INVALID\_PB\_TYPE** Invalid Phone Book type

**NO\_SIM** Action is being performed on a SIM that is not initialized.

**PB\_NOT\_READY** Phone Book not ready

**PIN\_RESTRICTION** PIN restriction

**PIN2\_RESTRICTION** PIN2 restriction

**PUK\_RESTRICTION** PUK restriction

**PUK2\_RESTRICTION** PUK2 restriction

**PB\_ACCESS\_RESTRICTED** Phone Book access restricted

**PB\_DELETE\_IN\_PROG** Phone Book delete in progress

**PB\_TEXT\_TOO\_LONG** Phone Book text too long

**PB\_NUMBER\_TOO\_LONG** Phone Book number too long

**PB\_HIDDEN\_KEY\_RESTRICTION** Phone Book hidden key restriction

**PB\_NOT\_AVAILABLE** Phone Book not available

**DEVICE\_MEMORY\_ERROR** Device memory error

**NO\_PERMISSION** No permission



**TOO\_SOON** Too soon  
**TIME\_NOT\_ACQUIRED** Time not acquired  
**OP\_IN\_PROGRESS** Operation is in progress  
**DS\_PROFILE\_REG\_RESULT\_FAIL** General failure  
**DS\_PROFILE\_REG\_RESULT\_ERR\_INVALID\_HNDL** Request contains an invalid profile handle  
**DS\_PROFILE\_REG\_RESULT\_ERR\_INVALID\_OP** Invalid operation was requested  
**DS\_PROFILE\_REG\_RESULT\_ERR\_INVALID\_PROFILE\_TYPE** Request contains an invalid technology type  
**DS\_PROFILE\_REG\_RESULT\_ERR\_INVALID\_PROFILE\_NUM** Request contains an invalid profile number  
**DS\_PROFILE\_REG\_RESULT\_ERR\_INVALID\_IDENT** Request contains an invalid profile identifier  
**DS\_PROFILE\_REG\_RESULT\_ERR\_INVALID** Request contains an invalid argument other than profile number and profile identifier received  
**DS\_PROFILE\_REG\_RESULT\_ERR\_LIB\_NOT\_INITED** Profile registry has not been initialized yet  
**DS\_PROFILE\_REG\_RESULT\_ERR\_LEN\_INVALID** Request contains a parameter with invalid length  
**DS\_PROFILE\_REG\_RESULT\_LIST\_END** End of the profile list was reached while searching for the requested profile  
**DS\_PROFILE\_REG\_RESULT\_ERR\_INVALID\_SUBS\_ID** Request contains an invalid subscription identifier  
**DS\_PROFILE\_REG\_INVALID\_PROFILE\_FAMILY** Request contains an invalid profile family  
**DS\_PROFILE\_REG\_PROFILE\_VERSION\_MISMATCH** [Version](#) mismatch  
**REG\_RESULT\_ERR\_OUT\_OF\_MEMORY** Out of memory  
**DS\_PROFILE\_REG\_RESULT\_ERR\_FILE\_ACCESS** File access error  
**DS\_PROFILE\_REG\_RESULT\_ERR\_EOF** End of field  
**REG\_RESULT\_ERR\_VALID\_FLAG\_NOT\_SET** A valid flag is not set  
**REG\_RESULT\_ERR\_OUT\_OF\_PROFILES** Out of profiles  
**REG\_RESULT\_NO\_EMERGENCY\_PDN\_SUPPORT** No emergency PDN support  
**V2X\_ERR\_EXCEED\_MAX** Exceed max allowed number  
**V2X\_ERR\_V2X\_DISABLED** V2x mode was not enabled  
**V2X\_ERR\_UNKNOWN\_SERVICE\_ID** The service id unknown  
**V2X\_ERR\_SRV\_ID\_L2\_ADDRS\_NOT\_COMPATIBLE** The service Id mismatch with L2 addr  
**V2X\_ERR\_PORT\_UNAVAIL** The port was occupied by others  
**DS\_PROFILE\_3GPP\_INVALID\_PROFILE\_FAMILY** Request contains an invalid 3GPP profile family  
**DS\_PROFILE\_3GPP\_ACCESS\_ERR** Error was encountered while accessing the 3GPP profiles  
**DS\_PROFILE\_3GPP\_CONTEXT\_NOT\_DEFINED** Specified 3GPP profile does not have a valid context  
**DS\_PROFILE\_3GPP\_VALID\_FLAG\_NOT\_SET** Specified 3GPP profile is marked invalid  
**DS\_PROFILE\_3GPP\_READ\_ONLY\_FLAG\_SET** Specified 3GPP profile is marked read-only  
**DS\_PROFILE\_3GPP\_ERR\_OUT\_OF\_PROFILES** Creation of a new 3GPP profile failed because the limit of 16 profiles has already been reached  
**DS\_PROFILE\_3GPP2\_ERR\_INVALID\_IDENT\_FOR\_PROFILE** Invalid profile identifier was received as part of the 3GPP2 profile modification request  
**DS\_PROFILE\_3GPP2\_ERR\_OUT\_OF\_PROFILE** Creation of a new 3GPP2 profile failed because the limit has already been reached  
**INTERNAL\_ERROR** Internal error  
**SERVICE\_ERROR** Service error  
**TIMEOUT\_ERROR** Timeout error  
**EXTENDED\_ERROR** Extended error  
**PORT\_NOT\_OPEN\_ERROR** Port not open  
**MEMCOPY\_ERROR** Memory copy error  
**INVALID\_TRANSACTION** Invalid transaction

**ALLOCATION\_FAILURE** Allocation failure  
**TRANSPORT\_ERROR** Transport error  
**PARAM\_ERROR** Parameter error  
**INVALID\_CLIENT** Invalid client  
**FRAMEWORK\_NOT\_READY** Framework not ready  
**INVALID\_SIGNAL** Invalid signal  
**TRANSPORT\_BUSY\_ERROR** Transport busy error  
**SUBSYSTEM\_UNAVAILABLE** Underlying service currently unavailable  
**OPERATION\_TIMEOUT** Timeout error  
**ROLLBACK\_FAILED** Rollback to initial state failed  
**ROT\_ALREADY\_SET** Root of trust already configured  
**UNSUPPORTED\_PURPOSE** Unsupported use of the key  
**INCOMPATIBLE\_PURPOSE** Incompatible purpose  
**UNSUPPORTED\_ALGO** Unsupported algorithm  
**INCOMPATIBLE\_ALGO** Incompatible algorithm  
**UNSUPPORTED\_KEY\_SIZE** Unsupported key size  
**UNSUPPORTED\_BLOCK\_MODE** Unsupported block mode  
**INCOMPATIBLE\_BLOCK\_MODE** Incompatible block mode  
**UNSUPPORTED\_MAC\_LEN** Unsupported MAC length  
**UNSUPPORTED\_PADDING\_MODE** Unsupported padding mode  
**UNSUPPORTED\_DIGEST** Unsupported digest  
**INCOMPATIBLE\_DIGEST** Incompatible digest  
**INVAL\_EXP\_TIME** Invalid expiration time  
**INVAL\_USR\_ID** Invalid user ID  
**INVAL\_AUTH\_TIMEOUT** Invalid authorization timeout  
**UNSUPPORTED\_KEY\_FMT** Unsupported key format  
**INCOMPATIBLE\_KEY\_FMT** Incompatible key format  
**UNSUPPORTED\_KEY\_ENC\_ALGO** Unsupported key encryption algorithm (for PKCS8 & PKCS12)  
**UNSUPPORTED\_KEY\_VRFY\_ALGO** Unsupported key verification algorithm (for PKCS8 & PKCS12)  
**INVAL\_IN\_LEN** Invalid input length  
**INVAL\_KEY\_EXPRT\_OPTNS** Invalid oprions for key export  
**DELEGATION\_NOT\_ALLOWED** Delegation not allowed  
**KEY\_NOT\_YET\_VALID** Key still not valid  
**KEY\_EXPIRED** Key has expired  
**KEY\_USR\_NOT\_AUTHENTICATED** Key user not authenticated  
**OUT\_PARAMETER\_NULL** Null output argument  
**INVAL\_OPERATION\_HNDL** Invalid operation handle  
**INSUFFICIENT\_BUF\_SPACE** Insufficient buffer space  
**VERIFICATION\_FAILED** Verification failed  
**TOO\_MANY\_OPS** Too many operations  
**UNEXPECTED\_NULL\_PTR** Unexpected null pointer  
**INVAL\_KEY\_BLOB** Invalid key blob  
**IMPORTED\_KEY\_NOT\_ENC** Imported key not encrypted  
**IMPORTED\_KEY\_DEC\_FAIL** Imported key decryption failed  
**IMPORTED\_KEY\_NOT\_SIGNED** Imported key not signed  
**IMPORTED\_KEY\_VRFY\_FAIL** Imported key verification failed  
**UNSUPPORTED\_TAG** Unsupported tag  
**INVAL\_TAG** Invalid TAG  
**IMPORT\_PARAM\_MISMATCH** Mismatch in import parameters

**SEC\_HW\_ACCESS\_DENIED** Secure hardware access denied  
**CONCUR\_ACCESS\_CONFLICT** Concurrent access conflict  
**SEC\_HW\_BUSY** Secure hardware busy  
**SEC\_HW\_COM\_FAIL** Secure hardware communication failed  
**UNSUPPORTED\_EC\_FIELD** Unsupported EC field  
**MISSING\_NONCE** Missing nonce  
**INVAL\_NONCE** Invalid nonce  
**MISSING\_MAC\_LEN** Missing MAC length  
**KEY\_RATE\_LIMIT\_EXCEEDED** Key limit exceeded  
**CALLER\_NONCE\_PROHIBITED** Caller nonce prohibited  
**KEY\_MAX\_OPS\_EXCEEDED** Key maximum operations exceeded  
**INVAL\_MAC\_LEN** Invalid MAC length  
**MISSING\_MIN\_MAC\_LEN** Missing minimum MAC length  
**UNSUPPORTED\_MIN\_MAC\_LEN** Unsupported minimum MAC length  
**UNSUPPORTED\_KDF** Unsupported KDF  
**UNSUPPORTED\_EC\_CURVE** Unsupported EC curve  
**KEY\_REQ\_UPGRADE** Key requires upgrade  
**ATTESTATION\_CHLNG\_MIS** Attestation challenge missing  
**KM\_NOT\_CONFIGRD** Keymaster not configured  
**ATTESTATION\_APPID\_MIS** Attestation app ID missing  
**CANNOT\_ATTEST\_IDS** Can not attest IDs  
**UNIMPLEMENTED** Unimplemented  
**VER\_MISMATCH** [Version](#) mismatch  
**SOTER\_ERR** Soter error  
**DMA\_ERR** HSDMA error  
**DIV\_ERR** Divided by error  
**OVERFLOW\_UNDERFLOW** Arithmetic overflow or underflow  
**RNG\_UNSEEDED** Read from unseeded ring  
**MEM\_ERR** Memory read  
**MODULUS\_ERR** Modulus error  
**DECODING\_ERR** Decode error  
**INVALID\_LENGTH** Invalid length of data

#### 4.19.2.3 enum telux::common::ServiceStatus [strong]

Service status.

##### Enumerator

**SERVICE\_UNAVAILABLE**  
**SERVICE\_AVAILABLE**  
**SERVICE\_FAILED**

#### 4.19.2.4 enum telux::common::ProcType [strong]

This applies in system architectures where the modem is attached to an External Application Processor(EAP). The operations associated with the ProcType can be performed by SDK either on EAP or the modem's Internal Application Processor(IAP). This type specifies where the operation is carried out.

**Enumerator**

**LOCAL\_PROC** Perform the operation on the processor where the API is invoked.

**REMOTE\_PROC** Perform the operation on the application processor other than where the API is invoked.

**4.19.2.5 enum telux::common::LogLevel [strong]**

Indicates supported logging levels.

**Enumerator**

**LEVEL\_NONE**

**LEVEL\_PERF** Prints messages with nanoseconds precision timestamp

**LEVEL\_ERROR** Prints perf and error messages only

**LEVEL\_WARNING** Prints perf, error and warning messages

**LEVEL\_INFO** Prints perf, errors, warning and information messages

**LEVEL\_DEBUG** Full logging including debug messages

## 4.20 C APIs

- [C Common APIs](#)
- [C Kinematics APIs](#)
- [C Radio APIs](#)
- [C Vehicle APIs](#)
- [C Config APIs](#)
- [C Packet APIs](#)

This section contains C APIs related to Cellular-V2X operation.

## 4.21 C Common APIs

This section contains C Common APIs related to Cellular-V2X operation.

The following common typedefs and macros are used by the C-V2X C APIs.

### 4.21.1 Data Structure Documentation

#### 4.21.1.1 struct v2x\_api\_ver\_t

Contains retrieved information about the SDK API library that is called. Each SDK component (Kinematics, Radio, Vehicle Data) implements a method to return this structure.

##### Data fields

Type	Field	Description
uint32_t	version_num	Version number of the interface.
char	build_date_↔ str[128]	Date of the build (part of the data string).
char	build_time_↔ str[128]	Time of the build (part of the data string).
char	build_details↔ _str[128]	Build details (part of the data string).

### 4.21.2 Enumeration Type Documentation

#### 4.21.2.1 enum v2x\_status\_enum\_type

Valid types for subsystem status, and return status codes for API function calls and callbacks.

##### Enumerator

**V2X\_STATUS\_SUCCESS** Operation is successful.

**V2X\_STATUS\_FAIL** Operation is unsuccessful. This is a generic error failure status that can be due to radio hardware resource limitations, geofencing, and so on.

**V2X\_STATUS\_ENO\_MEMORY** Failure due to a memory allocation issue.

**V2X\_STATUS\_EBADPARAM** One of the supplied parameters is bad.

**V2X\_STATUS\_EALREADY** Attempted step was already issued, and this call is not required.

**V2X\_STATUS\_KINEMATICS\_PLACEHOLDER** Begin the return codes associated with the Kinematics interface.

**V2X\_STATUS\_RADIO\_PLACEHOLDER** Begin the return codes associated with the Radio interface.

**V2X\_STATUS\_ECHANNEL\_UNAVAILABLE** Requested radio frequency cannot be used at this time.

**V2X\_STATUS\_RADIO\_NOT\_READY** Radio initialization failed due to v2x status.

**V2X\_STATUS\_VEHICLE\_PLACEHOLDER** Begin the return codes associated with the Vehicle Data interface.

## 4.22 C Kinematics APIs

This section contains C Kinematics APIs related to Cellular-V2X operation. For any new CV2x development, it is recommended to use the C++ [telux::loc::ILocationManager](#) APIs.

Abstraction of the system GNSS + DR solution for returning precision fixes with low latency via callbacks. This solution is used each time a fix is available, and it supports multiple callbacks to a short list of clients.

Common types are used for the motion and location reporting system of the platform. These types include the structures that are used to both configure the Kinematics subsystem and to report periodic fixes. The fixes are combinations of inertial/motion data and GNSS solutions determined (possibly directly) from satellite processing or dead-reckoning in degraded SV reception.

### 4.22.1 Define Documentation

#### 4.22.1.1 #define V2X\_KINEMATICS\_HANDLE\_BAD (-1)

Invalid handle returned by [v2x\\_kinematics\\_init\(\)](#) upon an error.

### 4.22.2 Data Structure Documentation

#### 4.22.2.1 struct v2x\_GNSSstatus\_t

Contains status information for the GNSS satellite.

This structure is used for each reported fix to indicate the quality of the available constellation (or whether the constellation is not available).

#### Data fields

Type	Field	Description
bool	unavailable	Specifies whether a constellation is not equipped or is unavailable. <b>Supported values:</b> <ul style="list-style-type: none"> <li>• 0 – GNSS is available</li> <li>• 1 – GNSS is unavailable</li> </ul>
bool	aPDOPof↔ Under5	Specifies whether dilution of precision is greater than 5. <b>Supported values:</b> <ul style="list-style-type: none"> <li>• 0 – Not greater than 5</li> <li>• 1 – Greater than 5</li> </ul>
bool	inViewOf↔ Under5	Specifies whether fewer than five satellites are in view. <b>Supported values:</b> <ul style="list-style-type: none"> <li>• 0 – Five or more satellites are in view</li> <li>• 1 – Fewer than five satellites are in view</li> </ul>
bool	local↔ Corrections↔ Present	Specifies whether DGPS type corrections are used. <b>Supported values:</b> <ul style="list-style-type: none"> <li>• 0 – Not used</li> <li>• 1 – Used</li> </ul>

Type	Field	Description
bool	network↔ Corrections↔ Present	Specifies whether RTK type corrections are used.  <b>Supported values:</b> <ul style="list-style-type: none"> <li>• 0 – Not used</li> <li>• 1 – Used</li> </ul>

#### 4.22.2.2 struct v2x\_gnss\_fix\_rates\_supported\_list\_t

Defines supported GNSS fix generation rates (such as 1 Hz, 5 Hz, 10 Hz).

##### Data fields

Type	Field	Description
uint32_t	qty_rates_↔ supported	Specify whether the listing or discovery of the supported rates is supported.  <b>Supported values:</b> <ul style="list-style-type: none"> <li>• 0 – Not supported</li> <li>• 1 – Supported</li> </ul>
pb_size_t	rates_↔ supported_hz_↔ _array_count	Number of supported rates.
uint32_t	rates_↔ supported_hz_↔ _array[32]	Array of data rates supported by the API.

#### 4.22.2.3 struct v2x\_init\_t

Defines client initialization.

##### Data fields

Type	Field	Description
uint32_t	log_level_mask	Log levels as defined in syslog.h.
char	server_ip_↔ addr[32]	IP address of the server.



#### 4.22.2.4 struct v2x\_kinematics\_capabilities\_t feature\_flags\_t

Defines Kinematics features supported by the hardware.

##### Data fields

Type	Field	Description
bool	has_3_axis_↔ gyro	Specifies whether the hardware supports 3-axis gyro. <b>Supported values:</b> <ul style="list-style-type: none"> <li>• 0 – Not supported</li> <li>• 1 – Supported</li> </ul>
bool	has_3_axis_↔ accelerometer	Specifies whether the hardware supports the 3-axis accelerometer. <b>Supported values:</b> <ul style="list-style-type: none"> <li>• 0 – Not supported</li> <li>• 1 – Supported</li> </ul>
bool	has_imu_↔ supplemented_↔ _dead_↔ reckoning	Specifies whether a dead reckoning (DR) solution is available and enabled or only GNSS is the result. <b>Supported values:</b> <ul style="list-style-type: none"> <li>• 0 – GNSS is available</li> <li>• 1 – DR is available</li> </ul>
bool	has_yaw_rate_↔ _sensor	Specifies whether the IMU includes a yaw rate sensor. <b>Supported values:</b> <ul style="list-style-type: none"> <li>• 0 – Does not include sensor</li> <li>• 1 – Includes sensor</li> </ul>
bool	used_vehicle_↔ _speed	Specifies whether the DR algorithm uses the vehicle speed sensor. <b>Supported values:</b> <ul style="list-style-type: none"> <li>• 0 – Does not use sensor</li> <li>• 1 – Uses sensor</li> </ul>
bool	used_single_↔ wheel_ticks	Specifies whether the DR algorithm uses the single wheel ticks. <b>Supported values:</b> <ul style="list-style-type: none"> <li>• 0 – Does not use ticks</li> <li>• 1 – Uses ticks</li> </ul>
bool	used_front_↔ differential_↔ wheel_ticks	Specifies whether the DR algorithm uses two front differential wheel ticks. <b>Supported values:</b> <ul style="list-style-type: none"> <li>• 0 – Does not use ticks</li> <li>• 1 – Uses ticks</li> </ul>
bool	used_rear_↔ differential_↔ wheel_ticks	Specifies whether the DR algorithm uses two rear differential wheel ticks. <b>Supported values:</b> <ul style="list-style-type: none"> <li>• 0 – Does not use ticks</li> <li>• 1 – Uses ticks</li> </ul>

Type	Field	Description
bool	used_vehicle_↔ _dynamic_↔ model	Specifies whether the DR algorithm uses vehicle dynamic model factoring in differential ticks, steering, and so on. <b>Supported values:</b> <ul style="list-style-type: none"> <li>• 0 – Does not use factoring</li> <li>• 1 – Uses factoring</li> </ul>

#### 4.22.2.5 struct v2x\_rates\_t

Defines the rate type.

##### Data fields

Type	Field	Description
uint32_t	rate_report_hz	Requested or reported current number of fixes per second.
uint32_t	offset_↔ nanoseconds	Currently unsupported.

#### 4.22.2.6 struct v2x\_kinematics\_capabilities\_t

Returned via v2x\_kinematics\_get\_capabilities() for the client to discover the lower level function that this system supports.

##### Data fields

Type	Field	Description
v2x_↔ kinematics_↔ _capabilities_↔ _t_feature_↔ flags_t	feature_flags	Features supported by the API.
uint32_t	max_fix_rate_↔ _supported_hz	Highest rate platform that supports GNSS fix generation (in Hz).
v2x_gnss_↔ fix_rates_↔ supported_↔ list_t	rates_list	Supported fix rates.

### 4.22.2.7 struct v2x\_location\_fix\_t

Contains a standardized set of parameters that are used for ITS applications.

The contents of this structure do not include every possible GNSS element (for example, raw range data is not included). These fields are via low latency for safety applications, both to use locally and to load into a J2945/1 or ETSI G5 EN302.637-2 CAM. For example, the fields are used for CAM-type and BSM-type safety beacons.

This structure is populated for each location or dead-reckoning fix, and it is supplied on the fix available callback.

Predefined J2735s can be used to communicate raw SV observations and RTK correction data. Currently, however, they are not supplied from this structure.

#### Data fields

Type	Field	Description
double	utc_fix_time	UTC time in seconds.
<a href="#">v2x_fix_mode_t</a>	fix_mode	Location engine used to produce this record. <b>Supported values:</b> No fix, 2D, 3D, RTCM
double	latitude	Latitude in degrees.
double	longitude	Longitude in degrees.
double	altitude	Altitude in meters above the geoid (mean sea level).
uint32_t	qty_SV_in_view	Number of usable space vehicles (SV) that should be in view.
uint32_t	qty_SV_used	Actual number of SVs used in this fix calculation.
<a href="#">v2x_GNSS_status_t</a>	gnss_status	Status of the GNSS data.
bool	has_SemiMajorAxisAccuracy	Specifies whether the value of the SemiMajorAxisAccuracy field is valid. <b>Supported values:</b> <ul style="list-style-type: none"> <li>• 0 – Not valid</li> <li>• 1 – Valid</li> </ul>
double	SemiMajorAxisAccuracy	Accuracy of the major axis, in meters.
bool	has_SemiMinorAxisAccuracy	Specifies whether the value of the SemiMinorAxisAccuracy field is valid. <b>Supported values:</b> <ul style="list-style-type: none"> <li>• 0 – Not valid</li> <li>• 1 – Valid</li> </ul>
double	SemiMinorAxisAccuracy	Accuracy of the minor axis, in meters.
bool	has_SemiMajorAxisOrientation	Specifies whether the value of the SemiMajorAxisOrientation field is valid. <b>Supported values:</b> <ul style="list-style-type: none"> <li>• 0 – Not valid</li> <li>• 1 – Valid</li> </ul>

Type	Field	Description
double	SemiMajor↔ AxisOrientation	Orientation of the major axis, in meters.
bool	has_heading	Specifies whether the value of the heading field is valid. <b>Supported values:</b> <ul style="list-style-type: none"> <li>• 0 – Not valid</li> <li>• 1 – Valid</li> </ul>
double	heading	Track degrees relative to true north.
bool	has_velocity	Specifies whether the value of the velocity field is valid. <b>Supported values:</b> <ul style="list-style-type: none"> <li>• 0 – Not valid</li> <li>• 1 – Valid</li> </ul>
double	velocity	Speed over ground in meters/second.
bool	has_climb	Specifies whether the value of the climb field is valid. <b>Supported values:</b> <ul style="list-style-type: none"> <li>• 0 – Not valid</li> <li>• 1 – Valid</li> </ul>
double	climb	Vertical speed in meters/second.
bool	has_lateral_↔ acceleration	Specifies whether the value of the lateral_acceleration field is valid. <b>Supported values:</b> <ul style="list-style-type: none"> <li>• 0 – Not valid</li> <li>• 1 – Valid</li> </ul>
double	lateral_↔ acceleration	Acceleration in a latitudinal direction, in meters/second <sup>^2</sup> .
bool	has_↔ longitudinal_↔ acceleration	Specifies whether the value of the longitudinal acceleration field is valid. <b>Supported values:</b> <ul style="list-style-type: none"> <li>• 0 – Not valid</li> <li>• 1 – Valid</li> </ul>
double	longitudinal_↔ acceleration	Acceleration in a longitudinal direction, in meters/second <sup>^2</sup> .
bool	has_vehicle_↔ vertical_↔ acceleration	Specifies whether the value of the vehicle_vertical_acceleration field is valid. <b>Supported values:</b> <ul style="list-style-type: none"> <li>• 0 – Not valid</li> <li>• 1 – Valid</li> </ul>
double	vehicle_↔ vertical_↔ acceleration	Vertical acceleration of the vehicle in G force.
bool	has_yaw_rate↔ _degrees_per↔ _second	Specifies whether the value of the yaw_rate_degrees_per_second field is valid. <b>Supported values:</b> <ul style="list-style-type: none"> <li>• 0 – Not valid</li> <li>• 1 – Valid</li> </ul>

Type	Field	Description
double	yaw_rate_↔ degrees_per_↔ second	Yaw rate in degrees/second, per SAE J2735.
bool	has_yaw_rate↔ _95pct_↔ confidence	Specifies whether the value of the yaw_rate_95pct_confidence field is valid. <b>Supported values:</b> <ul style="list-style-type: none"> <li>• 0 – Not valid</li> <li>• 1 – Valid</li> </ul>
double	yaw_rate_↔ 95pct_↔ confidence	95% confidence (2 sigma) on the yaw rate in degrees/second.
bool	has_lane_↔ position_↔ number	Specifies whether the value of the lane_position_number field is valid. <b>Supported values:</b> <ul style="list-style-type: none"> <li>• 0 – Not valid</li> <li>• 1 – Valid</li> </ul>
double	lane_position↔ _number	Current lane number, where 0 is either the outer-most edge of the hard shoulder or off-road.
bool	has_lane_↔ position_↔ 95pct_↔ confidence	Specifies whether the value of the lane_position_95pct_confidence field is valid. <b>Supported values:</b> <ul style="list-style-type: none"> <li>• 0 – Not valid</li> <li>• 1 – Valid</li> </ul>
double	lane_position↔ _95pct_↔ confidence	95% confidence range on the lane position.
bool	has_time_↔ confidence	Specifies whether the value of the time_confidence field is valid. <b>Supported values:</b> <ul style="list-style-type: none"> <li>• 0 – Not valid</li> <li>• 1 – Valid</li> </ul>
float	time_↔ confidence	95% (2 sigma) confidence in number of seconds.
bool	has_heading_↔ confidence	Specifies whether the value of the heading_confidence field is valid. <b>Supported values:</b> <ul style="list-style-type: none"> <li>• 0 – Not valid</li> <li>• 1 – Valid</li> </ul>
float	heading_↔ confidence	95% heading confidence in degrees.
bool	has_velocity_↔ confidence	Specifies whether the value of the velocity_confidence field is valid. <b>Supported values:</b> <ul style="list-style-type: none"> <li>• 0 – Not valid</li> <li>• 1 – Valid</li> </ul>
float	velocity_↔ confidence	95% velocity confidence in meters/second.

Type	Field	Description
bool	has_elevation↔ _confidence	Specifies whether the value of the elevation_confidence field is valid. <b>Supported values:</b> <ul style="list-style-type: none"> <li>• 0 – Not valid</li> <li>• 1 – Valid</li> </ul>
float	elevation_↔ confidence	95% uncertainty range (2 sigma) confidence in meters.
uint32_t	leap_seconds	Indicates that both UTC and GPS are required because IEEE 1609.2 security requires operations to be performed in raw GPS time.

## 4.22.3 Enumeration Type Documentation

### 4.22.3.1 enum v2x\_fix\_mode\_t

Valid GNSS fix modes.

#### Enumerator

**V2X\_GNSS\_MODE\_NOT\_SEEN** SV is unavailable or not in view.

**V2X\_GNSS\_MODE\_NO\_FIX** No SV fix.

**V2X\_GNSS\_MODE\_2D** 2D fix with latitude and longitude information.

**V2X\_GNSS\_MODE\_3D** 3D fix with latitude, longitude, and altitude information.

## 4.22.4 Function Documentation

### 4.22.4.1 v2x\_api\_ver\_t v2x\_kinematics\_api\_version ( void )

Gets the compiled API version interface (as an integer number).

#### Returns

[v2x\\_api\\_ver\\_t](#) – Filled with the version number, build date, and detailed build information.

#### 4.22.4.2 `v2x_kinematics_handle_t v2x_kinematics_init ( v2x_init_t * param, v2x_kinematics_init_callback_t cb, void * context )`

Initializes the Kinematics library.

##### Associated data types

[v2x\\_init\\_t](#)

[v2x\\_kinematics\\_init\\_callback\\_t](#)

##### Parameters

in	<i>param</i>	Pointer to the structure that contains parameters for the IP address of the server, logging level, and so on.
in	<i>cb</i>	Callback function called when initialization is complete.
in	<i>context</i>	Pointer to the application context for use with the callbacks, which can help the caller code.

##### Returns

Handle number to use with subsequent calls.

[V2X\\_KINEMATICS\\_HANDLE\\_BAD](#) – Upon an error.

#### 4.22.4.3 `v2x_status_enum_type v2x_kinematics_start_rate_notification ( v2x_kinematics_handle_t handle, v2x_kinematics_rate_notification_listener_t cb, void * context )`

Gets the current rate and offset from the Kinematics library.

##### Associated data types

[v2x\\_kinematics\\_handle\\_t](#)

[v2x\\_kinematics\\_rate\\_notification\\_listener\\_t](#)

##### Parameters

in	<i>handle</i>	Handle number to use with subsequent calls. If there is an error in initialization, the value is -1.
in	<i>cb</i>	Callback function used to report rate notification changes.
in	<i>context</i>	Pointer to the application context for use with the callbacks, which can help the caller code.

##### Returns

Indication of success or failure from [v2x\\_status\\_enum\\_type](#).



#### 4.22.4.4 `v2x_status_enum_type v2x_kinematics_set_rate ( v2x_kinematics_handle_t handle, v2x_rates_t * rate, v2x_kinematics_set_rate_callback_t cb, void * context )`

Sets the current rate and offset from the Kinematics library.

##### Associated data types

[v2x\\_kinematics\\_handle\\_t](#)

[v2x\\_rates\\_t](#)

[v2x\\_kinematics\\_set\\_rate\\_callback\\_t](#)

##### Parameters

in	<i>handle</i>	Handle number to use with subsequent calls. If there is an error in initialization, the value is -1.
in	<i>rate</i>	Pointer to the rate structure filled with the fix timing parameters.
in	<i>cb</i>	Callback function called when rates and offsets are successfully set. This parameter can be NULL.
in	<i>context</i>	Pointer to the application context for use with the callbacks, which can help the caller code.

##### Returns

Indication of success or failure from [v2x\\_status\\_enum\\_type](#).

```
4.22.4.5 v2x_status_enum_type v2x_kinematics_register_listener ( v2x_kinematics_↔
    _handle_t handle, v2x_kinematics_newfix_listener_t listener, void * context
    )
```

Registers for a Kinematics result listener callback at the requested rate.

#### Associated data types

[v2x\\_kinematics\\_handle\\_t](#)

[v2x\\_kinematics\\_newfix\\_listener\\_t](#)

#### Parameters

in	<i>handle</i>	Handle number to use with subsequent calls. If there is an error in initialization, the value is -1.
in	<i>listener</i>	Callback function to use for this listener.
in	<i>context</i>	Pointer to the application context for use with the callbacks, which can help the caller code.

#### Detailed description

This function requests GNSS fix/motion callbacks at a specified rate (Hz) with a specified offset.

Only certain rates are supported (such as 1 Hz, 2 Hz, 5 Hz, 10 Hz), which are obtained from [v2x\\_kinematics\\_get\\_capabilities\(\)](#).

Currently, a request cannot be made for a rate slower than 1 Hz.

#### Returns

Indication of success or failure from [v2x\\_status\\_enum\\_type](#).

#### 4.22.4.6 `v2x_status_enum_type v2x_kinematics_deregister_listener ( v2x_kinematics_handle_t handle, v2x_kinematics_deregister_callback_t cb, void * context )`

Deregisters a previously registered GNSS fix that the listener established earlier via `v2x_kinematics_register_listener()`.

##### Associated data types

`v2x_kinematics_handle_t`  
`v2x_kinematics_deregister_callback_t`

##### Parameters

in	<i>handle</i>	Handle number of the registered fix.
in	<i>cb</i>	Callback function to use for this listener. This parameter can be NULL.
in	<i>context</i>	Pointer to the application context for use with the callbacks, which can help the caller code.

##### Returns

Indication of success or failure from `v2x_status_enum_type`.

#### 4.22.4.7 `v2x_status_enum_type v2x_kinematics_final ( v2x_kinematics_handle_t handle, v2x_kinematics_final_callback_t cb, void * context )`

Terminates the Kinematics library.

##### Associated data types

[v2x\\_kinematics\\_handle\\_t](#)

[v2x\\_kinematics\\_final\\_callback\\_t](#)

##### Parameters

in	<i>handle</i>	Handle number of the library.
in	<i>cb</i>	Callback function called when termination is complete. This parameter can be NULL.
in	<i>context</i>	Pointer to the application context for use with the callbacks, which can help the caller code.

##### Returns

Indication of success or failure from [v2x\\_status\\_enum\\_type](#).

#### 4.22.4.8 void v2x\_kinematics\_enable\_fixes ( v2x\_kinematics\_handle\_t *handle* )

Enables the Kinematics fixes from GNSS.

##### Associated data types

[v2x\\_kinematics\\_handle\\_t](#)

##### Parameters

in	<i>handle</i>	Unique identifier for the library.
----	---------------	------------------------------------

##### Returns

None.

#### 4.22.4.9 void v2x\_kinematics\_disable\_fixes ( v2x\_kinematics\_handle\_t *handle* )

Disables the Kinematics fixes from GNSS.

##### Associated data types

[v2x\\_kinematics\\_handle\\_t](#)

##### Parameters

in	<i>handle</i>	Unique identifier for the library.
----	---------------	------------------------------------

##### Returns

None.

## 4.23 C Radio APIs

This section contains C Radio APIs related to Cellular-V2X operation. Applications need to have "radio" Linux group permissions to be able to operate successfully with underlying services. For any new CV2x development, it is recommended to use the C++ [telux::cv2x::\\*](#) APIs.

Abstraction of the radio driver parameters for a V2X broadcast socket interface, including 3GPP CV2X QoS bandwidth contracts.

### 4.23.1 Define Documentation

#### 4.23.1.1 **#define V2X\_RADIO\_HANDLE\_BAD (-1)**

Invalid handle returned by [v2x\\_radio\\_init\(\)](#) and [v2x\\_radio\\_init\\_v2\(\)](#) upon an error.

#### 4.23.1.2 **#define V2X\_MAX\_RADIO\_SESSIONS (10)**

Limit on the number of simultaneous RmNet Radio interfaces this library can have open at once.

Typically, there are only a few actual radios. On the same radio however, one interface can be for IP traffic, and another interface can be for non-IP traffic.

#### 4.23.1.3 **#define V2X\_RX\_WILDCARD\_PORTNUM (9000)**

Wildcard value for a port number. When the wildcard is used, all V2X received traffic is routed.

#### 4.23.1.4 **#define MAX\_POOL\_IDS\_LIST\_LEN (20)**

Maximum length of the pool ID list that is returned in [v2x\\_iface\\_capabilities\\_t](#).

#### 4.23.1.5 **#define MAX\_MALICIOUS\_IDS\_LIST\_LEN (50)**

Maximum length of the malicious ID list that can be passed in [v2x\\_radio\\_update\\_trusted\\_ue\\_list\(\)](#).

#### 4.23.1.6 **#define MAX\_TRUSTED\_IDS\_LIST\_LEN (50)**

Maximum length of the trusted ID list that can be passed in [v2x\\_radio\\_update\\_trusted\\_ue\\_list\(\)](#).

#### 4.23.1.7 **#define MAX\_SUBSCRIBE\_SIDS\_LIST\_LEN (10)**

Maximum length for the subscribed service ID list that can be passed in [v2x\\_radio\\_rx\\_sock\\_create\\_and\\_bind\\_v2\(\)](#).

#### 4.23.1.8 **#define MAX\_FILTER\_IDS\_LIST\_LEN (50)**

Maximum length for the L2 ID list that can be passed in [v2x\\_set\\_l2\\_filters\(\)](#) and [v2x\\_cancel\\_l2\\_filters](#).

#### 4.23.1.9 **#define V2X\_MAX\_ANTENNAS\_SUPPORTED (2)**

Maximum number of antennas that is supported. Used in [v2x\\_tx\\_status\\_report\\_t](#)

**4.23.1.10 #define V2X\_MAX\_TX\_POOL\_NUM (2)**

Maximum number of V2X Tx pools that is supported. Used in [v2x\\_radio\\_status\\_ex\\_t](#)

**4.23.1.11 #define V2X\_MAX\_RX\_POOL\_NUM (4)**

Maximum number of V2X Rx pools that is supported. Used in [v2x\\_radio\\_status\\_ex\\_t](#)

**4.23.1.12 #define V2X\_MAX\_SLSS\_SYNC\_REF\_UE\_NUM (16)**

Maximum number of detected SLSS sync reference UEs. Used in [v2x\\_slss\\_rx\\_info\\_t](#)

**4.23.2 Data Structure Documentation****4.23.2.1 struct v2x\_status\_info\_t**

Encapsulates CV2X Tx/Rx status and cause of failure.

**Data fields**

Type	Field	Description
<a href="#">v2x_radio_status_type_t</a>	status	Tx/Rx status
<a href="#">v2x_radio_cause_type_t</a>	cause	Cause of failure

**4.23.2.2 struct v2x\_radio\_status\_t**

Encapsulates status of CV2X radio.

**Data fields**

Type	Field	Description
<a href="#">v2x_status_info_t</a>	tx_status	TX status
<a href="#">v2x_status_info_t</a>	rx_status	RX status

**4.23.2.3 struct v2x\_pool\_status\_t**

Encapsulates status for single TX/RX pool.

**Data fields**

Type	Field	Description
uint8_t	pool_id	pool ID
<a href="#">v2x_status_info_t</a>	status	Tx/Rx pool status

#### 4.23.2.4 struct v2x\_radio\_status\_ex\_t

V2X overall radio status and per pool status.

##### Data fields

Type	Field	Description
<a href="#">v2x_radio_status_t</a>	status	CV2X overall TX/RX status
uint8_t	tx_pool_size	Number of Tx pools in array of pool_status.
<a href="#">v2x_pool_status_t</a>	tx_pool_status[V2X_MAX_TX_POOL_NUM]	CV2X Tx pool status.
uint8_t	rx_pool_size	Number of Rx pools in array of pool_status.
<a href="#">v2x_pool_status_t</a>	rx_pool_status[V2X_MAX_RX_POOL_NUM]	CV2X Rx pool status.

#### 4.23.2.5 struct trusted\_ue\_info\_t

Contains time confidence, position confidence, and propagation delay for a trusted UE.

##### Data fields

Type	Field	Description
uint32_t	source_l2_id	L2 ID of the trusted source
float	time_uncertainty	Time uncertainty in milliseconds.
uint16_t	time_confidence_level	Deprecated. Use time_uncertainty instead. Confidence level of the time period. <b>Supported values:</b> 0 through 127, where 0 is invalid or unavailable and 127 is the most confident
uint16_t	position_confidence_level	Confidence level of the position. <b>Supported values:</b> 0 through 127, where 0 is invalid or unavailable and 127 is the most confident
uint32_t	propagation_delay	Propagation delay in microseconds.

#### 4.23.2.6 struct tx\_pool\_id\_info\_t

Contains minimum and maximum EARFCNs for a Tx pool ID. Multiple Tx Pools allow the same radio and overall frequency range to be shared for multiple types of traffic like V2V and V2X. Each pool ID and frequency range corresponds to a certain type of traffic. Both edge guard bands are not included in the EARFCN range reported. The calculation for the full bandwidth includes both edge guard bands is:  
bandwidth(MHz) = (max\_freq-min\_freq)/9. This struct is used in [v2x\\_iface\\_capabilities\\_t](#).



**Data fields**

<b>Type</b>	<b>Field</b>	<b>Description</b>
uint8_t	pool_id	ID of the Tx pool.
uint16_t	min_freq	Minimum EARFCN of this pool.
uint16_t	max_freq	Maximum EARFCN of this pool.

### 4.23.2.7 struct v2x\_iface\_capabilities\_t

Contains information on the capabilities of a Radio interface.

#### Data fields

Type	Field	Description
int	link_ip_MTU↔ _bytes	Maximum data payload length (in bytes) of a packet supported by the IP Radio interface.
int	link_non_ip↔ MTU_bytes	Maximum data payload length (in bytes) of a packet supported by the non-IP Radio interface.
v2x↔ concurrency↔ sel_t	max↔ supported↔ concurrency	Indicates whether this interface supports concurrent WWAN with V2X (PC5).
uint16_t	non_ip_tx↔ payload↔ offset_bytes	<p>Byte offset in a non-IP Tx packet before the actual payload begins. In 3GPP CV2X, the first byte after the offset is the 1-byte V2X Family ID.</p> <p>This offset is to the left for a per-packet Tx header that includes Tx information that might be inserted in front of the packet payload (in subsequent releases).</p> <p>An example of Tx information is MAC/Phy parameters (power, rate, retransmissions policy, and so on).</p> <p>Currently, this value is expected to be 0. But it is reserved to support possible per-packet Tx/Rx headers that might be added in future releases of this API.</p>
uint16_t	non_ip_rx↔ payload↔ offset_bytes	<p>Byte offset in a non-IP Rx packet before the actual payload begins. Initially, this value is zero. But it allows for later insertion of per-packet Rx information (sometimes called metadata) to be added to the front of the data payload. An example of Rx information is MAC/Phy measurements (receive signal strength, timestamps, and so on).</p> <p>The V2X Family ID is considered as part of the payload in the 3GPP CV2X. Higher layers (applications that are clients to this API) must remove or advance past that 1 byte to get to the more familiar actual WSMP/Geonetworking payload.</p>
uint16_t	int_min↔ periodicity↔ multiplier_ms	<p>Lowest number of milliseconds requested for a bandwidth.</p> <p>This value is also the basis for all possible bandwidth reservation periods. For example, if this multiplier=100 ms, applications can only reserve bandwidths of 100 ms, 200 ms, up to 1000 ms.</p>
uint16_t	int↔ maximum↔ periodicity_ms	Least frequent bandwidth periodicity that is supported. Above this value, use event-driven periodic messages of a period larger than this value.
unsigned	supports↔ 10ms↔ periodicity: 1	<p>Indicates whether n*10 ms periodicities are supported.</p> <p><b>Supported values:</b></p> <ul style="list-style-type: none"> <li>• 0 – Not supported</li> <li>• 1 – Supported</li> </ul>

Type	Field	Description
unsigned	supports_↔ 20ms_↔ periodicity: 1	Indicates whether an n*20 ms bandwidth reservation is supported. <b>Supported values:</b> <ul style="list-style-type: none"> <li>• 0 – Not supported</li> <li>• 1 – Supported</li> </ul>
unsigned	supports_↔ 50ms_↔ periodicity: 1	Indicates whether 50 ms periodicity is supported. <b>Supported values:</b> <ul style="list-style-type: none"> <li>• 0 – Not supported</li> <li>• 1 – Supported</li> </ul>
unsigned	supports_↔ 100ms_↔ periodicity: 1	Indicates whether the basic minimum periodicity of 100 ms is supported. <b>Supported values:</b> <ul style="list-style-type: none"> <li>• 0 – Not supported</li> <li>• 1 – Supported</li> </ul>
unsigned	max_quantity↔ _of_auto_↔ retrans: 4	Maximum number automatic retransmissions. <b>Supported values:</b> 0 through 15
unsigned	size_of_↔ layer2_mac_↔ address: 4	Size of the L2 MAC address. Different Radio Access Technologies have different-sized L2 MAC addresses: 802.11 has 6 bytes, whereas 3GPP PC5 has only 3 bytes. Because a randomized MAC address comes from an HSM with good pseudo random entropy, higher layers must know how many bytes of the MAC address to generate.
uint16_t	v2x_number_↔ of_priority_↔ levels	Number of different priority levels supported. For example, 8 is the current 3GPP standard (where a lower number means a higher priority).
uint16_t	highest_↔ priority_value	Least urgent priority number supported by this radio. Higher numbers are lower priority, so if the full range is supported, this value is <a href="#">V2X_PRIO_BACKGROUND</a> .
uint16_t	lowest_↔ priority_value	Highest priority value (most urgent traffic). Lower numbers are higher priority, so if the highest level supported this value is <a href="#">V2X_PRIO_MOST_URGENT</a> .
uint16_t	max_qty_SP↔ S_flows	Maximum number of supported SPS reservations.
uint16_t	max_qty_non↔ _SPS_flows	Maximum number of supported event flows (non-SPS ports).
int32_t	max_tx_pwr	Maximum supported transmission power in dBm.
int32_t	min_tx_pwr	Minimum supported transmission power in dBm.
uint32_t	tx_pool_ids_↔ supported_len	Length of the tx_pool_ids_supported array.
<a href="#">tx_pool_id_↔ info_t</a>	tx_pool_ids_↔ supported[M↔ <a href="#">AX_POOL_I↔ DS_LIST_L↔ EN]</a>	Array of Tx pool IDs and their associated minimum and maximum frequencies.

### 4.23.2.8 struct v2x\_tx\_bandwidth\_reservation\_t

Used when requesting a QoS bandwidth contract, which is implemented in PC5 3GPP V2-X radio as a *Semi Persistent Flow* (SPS).

The underlying radio providing the interface might support periodicities of various granularity in 100 ms integer multiples (such as 200 ms, 300 ms, and 400 ms).

The reservation is also used internally as a handle.

#### Data fields

Type	Field	Description
int	v2xid	Variable length 4-byte PSID or ITS_AID, or another application ID.
<a href="#">v2x_priority_et</a>	priority	Specifies one of the 3GPP levels of priority for the traffic that is pre-reserved on the SPS flow. Use <a href="#">v2x_radio_query_capabilities()</a> to get the exact number of supported priority levels.
int	period_↔ interval_ms	Bandwidth-reserved periodicity interval in milliseconds. There are limits on which intervals the underlying radio supports. Use the capabilities query method to discover the <code>int_min_periodicity_multiplier_ms</code> and <code>int_maximum_periodicity_ms</code> supported intervals.
int	tx_↔ reservation_↔ size_bytes	Number of Tx bandwidth bytes that are sent every periodicity interval.

### 4.23.2.9 struct v2x\_chan\_meas\_params\_t

Contains the measurement parameters for configuring the MAC/Phy radio channel measurements (such as CBR utilization).

The radio chip contains requests on radio measurement parameters that API clients can use to specify the following:

- How their higher-level application requires the CBR/CBP to be measured
- Over which time window
- When to send a report

#### Data fields

Type	Field	Description
int	channel_↔ measurement_↔ _interval_us	Duration in microseconds of the sliding window size.
int	rs_threshold_↔ decidbm	Parameter to the radio CBR measurement that is used for determining how busy the channel is. Signals weaker than the specified receive strength (RSRP, or RSSI) are not considered to be in use (busy).

### 4.23.2.10 struct v2x\_chan\_measurements\_t

Periodically returned by the radio with all measurements about the radio channel, such as the amount of noise and bandwidth saturation (channel\_busy\_percentage, or CBR).

#### Data fields

Type	Field	Description
float	channel_busy_↔ _percentage	No measurement parameters are supplied.
float	noise_floor	Measurement of the background noise for a quiet channel.
float	time_↔ uncertainty	V2X time uncertainty in milliseconds.

### 4.23.2.11 struct v2x\_radio\_calls\_t

Contains callback functions used in a v2x\_radio\_init() and v2x\_radio\_init\_v2 call.

The radio interface uses these callback functions for events such as completion of initialization, a Layer-02 MAC address change, or a status event (loss of sufficient GPS time precision to transmit).

These callbacks are related to a specific radio interface, and its MAC/Phy parameters, such as transmit power, bandwidth utilization, and changes in radio status.

#### Data Fields

- void(\* v2x\_radio\_init\_complete)(v2x\_status\_enum\_type status, void \*context)
- void(\* v2x\_radio\_status\_listener)(v2x\_event\_t event, void \*context)
- void(\* v2x\_radio\_chan\_meas\_listener)(v2x\_chan\_measurements\_t \*measurements, void \*context)
- void(\* v2x\_radio\_l2\_addr\_changed\_listener)(int new\_l2\_address, void \*context)
- void(\* v2x\_radio\_macphy\_change\_complete\_cb)(void \*context)
- void(\* v2x\_radio\_capabilities\_listener)(v2x\_iface\_capabilities\_t \*caps, void \*context)
- void(\* v2x\_service\_status\_listener)(v2x\_service\_status\_t status, void \*context)

#### 4.23.2.11.1 Field Documentation

##### 4.23.2.11.1.1 void(\* v2x\_radio\_calls\_t::v2x\_radio\_init\_complete)(v2x\_status\_enum\_type status, void \*context)

Callback that indicates initialization is complete.

#### Associated data types

[v2x\\_status\\_enum\\_type](#)

#### Parameters

in	<i>status</i>	Updated current radio status that indicates whether transmit and receive are ready.
in	<i>context</i>	Pointer to the context that was supplied during initial registration.

**4.23.2.11.1.2 void(\* v2x\_radio\_calls\_t::v2x\_radio\_status\_listener) (v2x\_event\_t event, void \*context)**

Callback made when the status in the radio changes. For example, in response to a fault when there is a loss of GPS timing accuracy.

**Deprecated**

This callback is deprecated, please consider use v2x\_ext\_radio\_status\_listener instead.

**Associated data types**

[v2x\\_event\\_t](#)

**Parameters**

in	<i>event</i>	Delivery of the event that just occurred, such losing the ability to transmit.
in	<i>context</i>	Pointer to the context of the caller who originally registered for this callback.

**4.23.2.11.1.3 void(\* v2x\_radio\_calls\_t::v2x\_radio\_chan\_meas\_listener) (v2x\_chan\_measurements\_t \*measurements, void \*context)**

Callback made from lower layers when periodic radio measurements are prepared.

**Associated data types**

[v2x\\_chan\\_measurements\\_t](#)

**Parameters**

in	<i>measurements</i>	Pointer to the periodic measurements.
in	<i>context</i>	Pointer to the context of the caller who originally registered for this callback.

**4.23.2.11.1.4 void(\* v2x\_radio\_calls\_t::v2x\_radio\_l2\_addr\_changed\_listener) (int new\_l2\_address, void \*context)**

Callback made by the platform SDK when the MAC address (L2 SRC address) changes.

**Parameters**

in	<i>new_l2_address</i>	New L2 source address as an integer (because the L2 address is 3 bytes).
in	<i>context</i>	Pointer to the context of the caller who originally registered for this callback.

**4.23.2.11.1.5 void(\* v2x\_radio\_calls\_t::v2x\_radio\_macphy\_change\_complete\_cb) (void \*context)**

Callback made to indicate that the requested radio MAC/Phy change (such as channel/frequency and power) has completed.

**Parameters**

in	<i>context</i>	Pointer to the context of the caller who originally registered for this callback.
----	----------------	---

**4.23.2.11.1.6 void(\* v2x\_radio\_calls\_t::v2x\_radio\_capabilities\_listener) (v2x\_iface\_capabilities\_t \*caps, void \*context)**

Callback made when V2X capabilities change.

**Associated data types**

[v2x\\_iface\\_capabilities\\_t](#)

**Parameters**

in	<i>caps</i>	Pointer to the capabilities of this interface.
in	<i>context</i>	Pointer to the context of the caller who originally registered for this callback.

**4.23.2.11.1.7 void(\* v2x\_radio\_calls\_t::v2x\_service\_status\_listener) (v2x\_service\_status\_t status, void \*context)**

Callback made when the service status changes.

**Associated data types**

[v2x\\_service\\_status\\_t](#)

**Parameters**

in	<i>status</i>	Service status.
in	<i>context</i>	Pointer to the context of the caller who originally registered for this callback.



### 4.23.2.12 struct v2x\_sps\_mac\_details\_t

Contains MAC information that is reported from the actual MAC SPS in the radio. The offsets can periodically change on any given transmission report.

#### Data fields

Type	Field	Description
uint32_t	periodicity_↔ in_use_ns	Actual transmission interval period (in nanoseconds) scheduled relative to 1PP 0:00.00 time.
uint16_t	currently_↔ reserved_↔ periodic_bytes	Actual number of bytes currently reserved at the MAC layer. This number can be slightly larger than original request.
uint32_t	tx_↔ reservation_↔ offset_ns	Actual offset, from a 1PPS pulse and Tx flow periodicity, that the MAC selected and is using for the transmit reservation.  If data goes to the radio with enough time, it can be transmitted on the medium in the next immediately scheduled slot.
uint64_t	utc_time_ns	Absolute UTC start time of next selected grant, in nanoseconds.

### 4.23.2.13 struct v2x\_per\_sps\_reservation\_calls\_t

Callback functions used in `v2x_radio_tx_sps_sock_create_and_bind()` calls.

#### Data Fields

- `void(* v2x_radio_l2_reservation_change_complete_cb)(void *context, v2x_sps_mac_details_t *details)`
- `void(* v2x_radio_sps_offset_changed)(void *context, v2x_sps_mac_details_t *details)`

#### 4.23.2.13.1 Field Documentation

##### 4.23.2.13.1.1 `void(* v2x_per_sps_reservation_calls_t::v2x_radio_l2_reservation_change_complete_cb)(void *context, v2x_sps_mac_details_t *details)`

Callback made upon completion of a reservation change that a `v2x_radio_tx_reservation_change()` call initiated for a MAC/Phy contention.

The current SPS offset and reservation parameter are passed in the details structure returned by the pointer details.

#### Associated data types

[v2x\\_sps\\_mac\\_details\\_t](#)

#### Parameters

in	<i>context</i>	Pointer to the application context.
in	<i>details</i>	Pointer to the MAC information.

#### 4.23.2.13.1.2 void(\* v2x\_per\_sps\_reservation\_calls\_t::v2x\_radio\_sps\_offset\_changed) (void \*context, v2x\_sps\_mac\_details\_t \*details)

Callback periodically made when the MAC SPS timeslot changes. The new reservation offset is in the details structure returned by pointer details.

#### Associated data types

[v2x\\_sps\\_mac\\_details\\_t](#)

#### Parameters

in	<i>measurements</i>	Pointer to the channel measurements.
in	<i>context</i>	Pointer to the context.

#### Detailed description

This callback can occur when a MAC contention triggers a new reservation time slot to be selected. It is relevant only to connections opened with [v2x\\_radio\\_tx\\_sps\\_sock\\_create\\_and\\_bind\(\)](#).

#### 4.23.2.14 struct v2x\_slss\_sync\_ref\_ue\_info\_t

Encapsulates parameters of an SLSS sync reference UE. Used in [v2x\\_slss\\_rx\\_info\\_t](#).

##### Data fields

Type	Field	Description
uint16_t	slss_id	The SLSS ID of the sync reference UE that is defined in 3GPP TS 36.331 chapter 6.3.8.
bool	in_coverage	Indicates whether or not the UE is in coverage of GNSS that is defined in 3GPP TS 36.331 chapter 6.5.2.
<a href="#">v2x_slss_sync_pattern_t</a>	pattern	Indicates the SLSS sync pattern of the UE that is defined in 3GPP TS 36.331 chapter 6.3.8.
uint8_t	rsrp	SLSS RSRP value of the UE in dBm is ((float)rsrp - 256)/2.
bool	selected	Indicates whether or not the sync reference UE has been selected as the timing source.

#### 4.23.2.15 struct v2x\_slss\_rx\_info\_t

Encapsulates parameters of CV2X SLSS Rx Information.

Used in [v2x\\_get\\_slss\\_rx\\_info](#) and [v2x\\_slss\\_rx\\_info\\_listener](#).

##### Data fields

Type	Field	Description
uint32_t	num_ue	The number of SLSS sync reference UEs in array ueInfo.
<a href="#">v2x_slss_sync_ref_ue_info_t</a>	ue_info[V2X_MAX_SLS_SYNC_REF_UE_NUM]	Array of detected SLSS sync reference UEs.

#### 4.23.2.16 struct v2x\_tx\_flow\_info\_t

Advanced parameters that can be specified for Tx SPS and event-driven flows.

##### Data fields

Type	Field	Description
<a href="#">v2x_auto_retransmit_policy_t</a>	retransmit_policy	V2X retransmit policy.
uint8_t	default_tx_power_valid	Indicates whether the default Tx power is specified. <b>Supported values:</b> <ul style="list-style-type: none"> <li>• 0 – Default power is not specified</li> <li>• 1 – Default power is specified and is valid</li> </ul>
int32_t	default_tx_power	Default power used for transmission.

Type	Field	Description
uint8_t	mcs_index_↔ valid	Indicates whether the MCS index is specified. <b>Supported values:</b> <ul style="list-style-type: none"> <li>• 0 – Index is not specified</li> <li>• 1 – Index is specified and is valid</li> </ul>
uint8_t	mcs_index	MCS index number
uint8_t	tx_pool_id_↔ valid	Indicates whether the Tx pool ID is valid. <b>Supported values:</b> <ul style="list-style-type: none"> <li>• 0 – ID is not specified</li> <li>• 1 – ID is specified and is valid</li> </ul>
uint8_t	tx_pool_id	ID of the Tx pool.
uint8_t	is_unicast_↔ valid	Indicates whether is_unicast is specified. <b>Supported values:</b> <ul style="list-style-type: none"> <li>• 0 – Is unicast is not specified</li> <li>• 1 – Is unicast is specified and is valid</li> </ul>
uint8_t	is_unicast	Non zero if requested flow is unicast. Note: Unicast flows ignore subscribed Service Ids

#### 4.23.2.17 struct v2x\_sock\_info\_t

Parameters to identify a Tx or Rx socket.

##### Data fields

Type	Field	Description
int	sock	Pointer to the file descriptor for the socket.
struct sockaddr_↔ in6	sockaddr	IPv6 socket address. The sockaddr_in6 buffer is initialized with the IPv6 source address and source port that are used for the bind() function.

#### 4.23.2.18 struct v2x\_sid\_list\_t

Parameters to identify a service ID list.

##### Data fields

Type	Field	Description
int	length	number of services IDs included in the array of sid.
uint32_t	sid[ <a href="#">MAX_S_↔</a> <a href="#">UBSCRIBE_↔</a> <a href="#">SIDS_LIST_↔</a> <a href="#">LEN</a> ]	array of service IDs.

#### 4.23.2.19 struct v2x\_tx\_sps\_flow\_info\_t

Advanced parameters that can be specified for Tx SPS flows.

##### Data fields

Type	Field	Description
<a href="#">v2x_tx_↔ bandwidth↔ _reservation_t</a>	reservation	Transmit reservation information.
<a href="#">v2x_tx_flow_↔ info_t</a>	flow_info	Transmit resource information about the SPS Tx flow.

#### 4.23.2.20 struct socket\_info\_t

Parameters that can be specified for the creation of CV2X socket.

##### Data fields

Type	Field	Description
uint32_t	service_id	V2X service ID bound to the CV2X socket.
uint16_t	local_port	Local port number of the CV2X socket used for binding.

#### 4.23.2.21 struct src\_l2\_filter\_info\_t

Contains remote UE source L2 ID that expecting to filter.

##### Data fields

Type	Field	Description
uint32_t	src_l2_id	< remote UE L2 addr to filter. Duration, in millisecond (resolution 100 msec).
uint32_t	duration_ms	/* Proximity service per packet priority (PPPP), packets with priority above this value will be dropped. Range 0-7, 0 mean all of the pkts will be dropped.
uint8_t	pppp	

#### 4.23.2.22 struct v2x\_rf\_tx\_info\_t

Tx status per Tx chain and Tx power per Tx antenna for a specific transport block.

##### Data fields

Type	Field	Description
<a href="#">rf_status_t</a>	status	Fault detection status for a specific Tx chain.
int32_t	power	The target Tx power after MPR/AMPR reduction for a specific Tx antenna in dBm*10 format. Invalid value is -700, it means the corresponding antenna is not being used for the transmission of this transport block.

### 4.23.2.23 struct v2x\_tx\_status\_report\_t

Information on Tx status of a V2X transport block that is reported from low layer.

1. A V2X Tx packet might trigger multiple reports because of the segmentaion and re-Tx in low layer.
2. If a transport block is dropped in low layer, no report will be triggered for that transport block.
3. The power in the array of rfInfo is the target Tx power value in dBm\*10 after MPR/AMPR reduction for a specific Tx antenna. The status in the array of rfInfo is the fault detection status for a specific Tx chain.
  - In CDD mode, two antennas have transmission for a specific transport block, both rfInfo[0].power and rfInfo[1].power are valid (not -700), rfInfo[i].status is reflecting the status of Tx chain/Tx antenna i.
  - In TXD mode, data transmission swtiches between two antennas/chains and only one antenna/chain has transmission for a specific transport block, the Tx antenna being used has valid power (not -700) in the array of rfInfo, rfInfo[i].status is reflecting the status of Tx chain i or the status of the Tx antenna i whose power is valid (not -700) in the array of rfInfo. Used in [v2x\\_tx\\_status\\_report\\_listener](#)

#### Data fields

Type	Field	Description
<a href="#">v2x_rf_tx_info_t</a>	<a href="#">rf_info[V2X_MAX_ANNAS_SUPPOTED]</a>	Tx status per Tx chain and Tx power per Tx antenna.
uint8_t	num_rb	Number of resource blocks used for the transport block.
uint8_t	start_rb	Start resource block index used for the transport block.
uint8_t	mcs	Modulation and coding scheme used for the transport block that is defined in 3GPP TS 36.213.
uint8_t	seg_num	Total number of segments of a V2X packet.
<a href="#">v2x_segment_type_t</a>	seg_type	Segment type of the transport block.
<a href="#">v2x_tx_type_t</a>	tx_type	Indication of new Tx or re-Tx of the transport block.
uint16_t	ota_timing	OTA timing in format of system frame number*10 + subframe number.
uint16_t	port	Port number that can be used to link the report to a specific Tx flow which has the same source port number.

## 4.23.3 Enumeration Type Documentation

### 4.23.3.1 enum v2x\_concurrency\_sel\_t

Describes whether the radio chip modem should attempt or support concurrent 3GPP CV2X operation with a WWAN 4G/5G data call.

Some chips are only capable of operating on CV2X. In this case:

- The callers can only request V2X\_WWAN\_NONCONCURRENT.

- The interface parameters that are returned list `v2x_concurrency_sel_t` as the value for `V2X_WAN_NONCONCURRENT`.

#### Enumerator

**`V2X_WWAN_NONCONCURRENT`** No simultaneous WWAN + CV2X on this interface.

**`V2X_WWAN_CONCURRENT`** Interface allows requests for concurrent support of WWAN + CV2X connections.

#### 4.23.3.2 enum `v2x_event_t`

Event indications sent asynchronously from the radio via callbacks that indicate the state of the radio. The state can change in response to the loss of timing precision or a geofencing change.

#### Deprecated

This enum type is deprecated, please consider use `v2x_radio_status_ex_t` instead.

#### Enumerator

**`V2X_INACTIVE`** V2X communication is disabled.

**`V2X_ACTIVE`** V2X communication is enabled. Transmit and receive are possible.

**`V2X_TX_SUSPENDED`** Small loss of timing precision occurred. Transmit is no longer supported.

**`V2X_RX_SUSPENDED`** Radio can no longer receive any messages.

**`V2X_TXRX_SUSPENDED`** Radio can no longer transmit or receive for some reason.



### 4.23.3.3 enum v2x\_priority\_et

Range of supported priority levels, where a lower number means a higher priority. For example, 8 is the current 3GPP standard.

#### Enumerator

**V2X\_PRIO\_MOST\_URGENT** Highest priority.  
**V2X\_PRIO\_1**  
**V2X\_PRIO\_2**  
**V2X\_PRIO\_3**  
**V2X\_PRIO\_4**  
**V2X\_PRIO\_5**  
**V2X\_PRIO\_6**  
**V2X\_PRIO\_BACKGROUND** Lowest priority.

### 4.23.3.4 enum v2x\_service\_status\_t

Valid service availability states.

#### Enumerator

**SERVICE\_UNAVAILABLE**  
**SERVICE\_AVAILABLE**  
**SERVICE\_FAILED**

### 4.23.3.5 enum v2x\_radio\_status\_type\_t

Defines possible values for CV2X radio RX/TX status.

1. If Rx is in inactive state, Tx should also be in inactive state.
2. If Rx is in active state, Tx should be in active(normal case) or suspended state(sensing or tunnel mode).
3. If Rx is in suspended state, Tx should be in suspended state. Used in [v2x\\_status\\_info\\_t](#)

#### Enumerator

**V2X\_RADIO\_STATUS\_INACTIVE** RX/TX is inactive  
**V2X\_RADIO\_STATUS\_ACTIVE** RX/TX is active  
**V2X\_RADIO\_STATUS\_SUSPENDED** RX/TX is suspended  
**V2X\_RADIO\_STATUS\_UNKNOWN** RX/TX status unknown

### 4.23.3.6 enum v2x\_radio\_cause\_type\_t

Defines possible values for cause of CV2X radio failure. The cause code is only associated with cv2x suspend/inactive status, if cv2x is active, the cause code has no meaning. Used in [v2x\\_status\\_info\\_t](#)

#### Enumerator

**V2X\_RADIO\_CAUSE\_TIMING** CV2X is suspended due to the outage of timing reference.  
**V2X\_RADIO\_CAUSE\_CONFIG** CV2X is inactive due to v2x.xml is missing, invalid, or expired.

- V2X\_RADIO\_CAUSE\_UE\_MODE** CV2X is inactive due to CV2X mode is not started.
- V2X\_RADIO\_CAUSE\_GEOPOLYGON** CV2X is inactive due to UE enters a geo-polygon that does not support cv2x.
- V2X\_RADIO\_CAUSE\_THERMAL** CV2X is suspended when the device's temperature is high.
- V2X\_RADIO\_CAUSE\_THERMAL\_ECALL** CV2X is suspended when the device's temperature is high and emergency call is ongoing.
- V2X\_RADIO\_CAUSE\_GEOPOLYGON\_SWITCH** CV2X is suspended when UE switches to a new geopolygon that also supports CV2X and UE is already in CV2X active status, CV2X status will change to active after the update is done.
- V2X\_RADIO\_CAUSE\_SENSING** CV2X Tx is suspended when GNSS signal recovers or CV2X mode just starts. UE needs sensing for 1 second before Tx can begin, Tx status will change to active after sensing is done.
- V2X\_RADIO\_CAUSE\_LPM** CV2X is inactive when UE enters Low Power Mode.
- V2X\_RADIO\_CAUSE\_DISABLED** CV2X is inactive due to CV2X is disabled in the EFS.
- V2X\_RADIO\_CAUSE\_NO\_GNSS** CV2X is inactive due to GNSS signal is not available when starting CV2X.
- V2X\_RADIO\_CAUSE\_INVALID\_LICENSE** CV2X is inactive due to invalid license.
- V2X\_RADIO\_CAUSE\_UNKNOWN** Invalid cause type only used internally.

#### 4.23.3.7 enum v2x\_auto\_retransmit\_policy\_t

V2X Tx retransmission policies supported by the modem.

##### Enumerator

- V2X\_AUTO\_RETRANSMIT\_DISABLED** Retransmit mode is disabled.
- V2X\_AUTO\_RETRANSMIT\_ENABLED** Retransmit mode is enabled.
- V2X\_AUTO\_RETRANSMIT\_DONT\_CARE** Modem falls back to its default behavior.

#### 4.23.3.8 enum v2x\_slss\_sync\_pattern\_t

Defines possible values for SLSS sync pattern. Used in [v2x\\_slss\\_sync\\_ref\\_ue\\_info\\_t](#)

##### Enumerator

- V2X\_SLSS\_SYNC\_PATTERN\_OFFSET\_IND\_1** UE transmits SLSS in subframes indicated by the syncOffsetIndicator1 specified in V2X configuration.
- V2X\_SLSS\_SYNC\_PATTERN\_OFFSET\_IND\_2** UE transmits SLSS in subframes indicated by the syncOffsetIndicator2 specified in V2X configuration.
- V2X\_SLSS\_SYNC\_PATTERN\_OFFSET\_IND\_3** UE transmits SLSS in subframes indicated by the syncOffsetIndicator3 specified in V2X configuration.
- V2X\_SLSS\_SYNC\_PATTERN\_ODD\_RESERVED** UE transmits SLSS in odd-numbered reserved subframes.
- V2X\_SLSS\_SYNC\_PATTERN\_EVEN\_RESERVED** UE transmits SLSS in even-numbered reserved subframes.
- V2X\_SLSS\_SYNC\_PATTERN\_UNKNOWN** Unkown SLSS sync pattern.

### 4.23.3.9 enum traffic\_ip\_type\_t

V2X Ip Types

#### Enumerator

**TRAFFIC\_IP** Use Ip type traffic.

**TRAFFIC\_NON\_IP** Use Non-Ip type traffic.

### 4.23.3.10 enum rf\_status\_t

Fault detection for Tx chain that including PA and front end.

#### Enumerator

- INACTIVE** The Tx chain is not working.
- OPERATIONAL** The Tx chain is operational.
- FAULT** Fault detected on the Tx chain.

### 4.23.3.11 enum v2x\_segment\_type\_t

Defines possible values for the segment type of a transport block.

#### Enumerator

- FIRST** V2X packet is segmented, it's the first transport block.
- LAST** V2X packet is segmented, it's the last transport block.
- MIDDLE** V2X packet is segmented, it's a transport block between first and last.
- ONLY\_ONE** V2X packet is not segmented, it's the only one transport block.

### 4.23.3.12 enum v2x\_tx\_type\_t

Defines new Tx or re-Tx type relevant to a transport block.

#### Enumerator

- V2X\_NEW\_TX** New Tx of the V2X transport block.
- V2X\_RE\_TX** Re-Tx of the V2X transport block.
- V2X\_SLSS\_TX** Tx of SLSS.

## 4.23.4 Function Documentation

### 4.23.4.1 uint16\_t v2x\_convert\_priority\_to\_traffic\_class ( v2x\_priority\_et priority )

Converts a traffic priority to one of the 255 IPv6 traffic class bytes that are used in the data plane to indicate per-packet priority on non-SPS (event driven) data ports.

#### Associated data types

[v2x\\_priority\\_et](#)

#### Parameters

in	<i>priority</i>	Packet priority that is to be converted to an IPv6 traffic class. This priority is between the lowest and highest priority values returned in <a href="#">v2x_iface_capabilities_t</a> .
----	-----------------	--

#### Detailed description

This function is symmetric and is a reverse operation.

The traffic priority is one of the values between `min_priority_value` and `max_priority_value` returned in the [v2x\\_iface\\_capabilities\\_t](#) query.

**Returns**

IPv6 traffic class for achieving the calling input parameter priority level.

#### 4.23.4.2 `v2x_priority_et v2x_convert_traffic_class_to_priority ( uint16_t traffic_class )`

Maps an IPv6 traffic class to a V2X priority value.

##### Parameters

in	<i>traffic_class</i>	IPv6 traffic classification that came in a packet from the radio.
----	----------------------	---

##### Detailed description

This function is the inverse of the `v2x_convert_priority_to_traffic_class()` function. It is symmetric and is a reverse operation.

##### Returns

Priority level (between highest and lowest priority values) equivalent to the input IPv6 traffic class parameter.

#### 4.23.4.3 `v2x_api_ver_t v2x_radio_api_version ( )`

Method used to query the platform SDK for its version number, build information, and build date.

##### Returns

`v2x_api_ver_t` – Contains the build date and API version number.

#### 4.23.4.4 `v2x_status_enum_type v2x_radio_query_capabilities ( v2x_iface_↔ capabilities_t * caps )`

Gets the capabilities of CV2X radio.

##### Associated data types

[v2x\\_iface\\_capabilities\\_t](#)

##### Parameters

out	<i>caps</i>	Pointer to the <a href="#">v2x_iface_capabilities_t</a> structure, which contains the capabilities of this specific interface.
-----	-------------	--

##### Returns

[V2X\\_STATUS\\_SUCCESS](#) – The radio is ready for data-plane sockets to be created and bound.

Error code – If there is a problem (see [v2x\\_status\\_enum\\_type](#)).

#### 4.23.4.5 `v2x_status_enum_type v2x_radio_deinit ( v2x_radio_handle_t handle )`

De-initializes a specific Radio interface.

##### Associated data types

[v2x\\_radio\\_handle\\_t](#)

##### Parameters

in	<i>handle</i>	Handle to the Radio that was initialized.
----	---------------	---

##### Returns

Indication of success or failure (see [v2x\\_status\\_enum\\_type](#)).

##### Dependencies

The interface must be pre-initialized with [v2x\\_radio\\_init\(\)](#) or [v2x\\_radio\\_init\\_v2\(\)](#). The handle from that function must be used as the parameter in this function.

#### 4.23.4.6 `int v2x_radio_rx_sock_create_and_bind ( v2x_radio_handle_t handle, int * sock, struct sockaddr_in6 * rx_sockaddr )`

Opens a new V2X radio receive socket, and initializes the given sockaddr buffer. The socket is also bound as an AF\_INET6 UDP type socket.

On platforms with access control enabled, the caller needs to have TELUX\_CV2X\_FLOW\_OPS permission to successfully invoke this API.

##### Associated data types

[v2x\\_radio\\_handle\\_t](#)

##### Parameters

in	<i>handle</i>	Identifies the initialized Radio interface.
out	<i>sock</i>	Pointer to the socket that, on success, returns the socket descriptor. The caller must release this socket with <a href="#">v2x_radio_sock_close()</a> .
out	<i>rx_sockaddr</i>	Pointer to the IPv6 UDP socket. The sockaddr_in6 buffer is initialized with the IPv6 source address and source port that are used for the bind.

##### Detailed description

You can execute any sockopts that are appropriate for this type of socket (AF\_INET6).

The port number for the receive path is not exposed, but it is in the sockaddr\_in6 structure (if the caller is interested).

##### Returns

0 – On success.

Otherwise:

- EPERM – Socket creation failed; for more details, check errno.h.
- EAFNOSUPPORT – On failure to find the interface.
- EACCES – On failure to get the MAC address of the device.

##### Dependencies

The interface must be pre-initialized with `v2x_radio_init()` or `v2x_radio_init_v2()`. The handle from that function must be used as the parameter in this function.



#### 4.23.4.7 int v2x\_radio\_rx\_sock\_create\_and\_bind\_v2 ( v2x\_radio\_handle\_t handle, int id\_ist\_len, uint32\_t \* id\_list, int \* sock, struct sockaddr\_in6 \* rx\_sockaddr )

Opens a new V2X radio receive socket with specific service IDs for subscription, and initializes the given sockaddr buffer. The socket is also bound as an AF\_INET6 UDP type socket.

On platforms with access control enabled, the caller needs to have TELUX\_CV2X\_FLOW\_OPS permission to successfully invoke this API.

##### Associated data types

[v2x\\_radio\\_handle\\_t](#)

##### Parameters

in	<i>handle</i>	Identifies the initialized Radio interface.
in	<i>id_ist_len</i>	Identifies the length of service ID list.
in	<i>id_list</i>	Pointer to the service ID list for subscription, subscribe wildcard if input nullptr.
out	<i>sock</i>	Pointer to the socket that, on success, returns the socket descriptor. The caller must release this socket with <a href="#">v2x_radio_sock_close()</a> .
out	<i>rx_sockaddr</i>	Pointer to the IPv6 UDP socket. The sockaddr_in6 buffer is initialized with the IPv6 source address and source port that are used for the bind.

##### Detailed description

You can execute any sockopts that are appropriate for this type of socket (AF\_INET6).

This API can be used to subscribe wildcard, catchall port, or specific service IDs. The Rx port should be set with `v2x_set_rx_port()` before any subscription via this API, otherwise a default port number 9000 will be used.

Wildcard is used to receive all traffic. Only one port can be registered as wildcard port. Once wildcard is registered successfully, all received packets will be directed to wildcard port, and any subscription for specific service IDs or catchall port at other ports will be invalid. The parameter `id_list` of this API should be set to a null list for wildcard subscription.

Catchall port is used to receive packets with non-registered service IDs (via specific service IDs subscription). Only one port can be registered as catchall port. If catchall port is registered successfully, received packets with non-registered service ID will be directed to catchall port. All specific service IDs subscription (if any) should be performed before catchall port subscription. The parameter `id_list` of this API should include all non-registered service IDs for catchall port subscription.

Any port different from catchall port can be used to receive packets with specific service IDs. Only one port can be registered for a single service ID, a list of service IDs can be registered at a single port. To subscribe specific service IDs at a given Rx port, a Tx flow must be pre-setup with the Tx service ID set to any service ID included in the list of specific service IDs and the Tx source port set to the same port number as Rx port. The parameter `id_list` of this API should include all interested service IDs for the given Rx port.

## Returns

0 – On success.

Otherwise:

- EPERM – Socket creation failed; for more details, check `errno.h`.
- EAFNOSUPPORT – On failure to find the interface.
- EACCES – On failure to get the MAC address of the device.

## Dependencies

The interface must be pre-initialized with `v2x_radio_init()`. The handle from that function must be used as the parameter in this function. The Rx port must be pre-set with `v2x_set_rx_port()`, otherwise a default port number will be used. For any specific service ID subscription, a Tx flow must be pre-setup using one of the following methods:

- [v2x\\_radio\\_tx\\_sps\\_sock\\_create\\_and\\_bind\(\)](#)
- [v2x\\_radio\\_tx\\_sps\\_sock\\_create\\_and\\_bind\\_v2\(\)](#)
- [v2x\\_radio\\_tx\\_sps\\_only\\_create\(\)](#)
- [v2x\\_radio\\_tx\\_sps\\_only\\_create\\_v2\(\)](#)
- [v2x\\_radio\\_tx\\_event\\_sock\\_create\\_and\\_bind\(\)](#)
- [v2x\\_radio\\_tx\\_event\\_sock\\_create\\_and\\_bind\\_v2\(\)](#)
- [v2x\\_radio\\_tx\\_event\\_sock\\_create\\_and\\_bind\\_v3\(\)](#)

#### 4.23.4.8 `int v2x_radio_rx_sock_create_and_bind_v3 ( v2x_radio_handle_t handle, uint16_t port_num, int id_ist_len, uint32_t * id_list, int * sock, struct sockaddr_in6 * rx_sockaddr )`

Opens a new V2X radio receive socket with specific service IDs for subscription and specific port number for the receive path, and initializes the given sockaddr buffer. The socket is also bound as an AF\_INET6 UDP type socket.

This `v2x_radio_rx_sock_create_and_bind_v3()` method differs from `v2x_radio_rx_sock_create_and_bind_v2()` in that you can use the `port_num` parameter to specify the port number for the receive path.

On platforms with access control enabled, the caller needs to have `TELUX_CV2X_FLOW_OPS` permission to successfully invoke this API.

#### Associated data types

[v2x\\_radio\\_handle\\_t](#)

#### Parameters

in	<i>handle</i>	Identifies the initialized Radio interface.
in	<i>port_num</i>	Identifies the port number for the receive path.
in	<i>id_ist_len</i>	Identifies the length of service ID list.
in	<i>id_list</i>	Pointer to the service ID list for subscription, subscribe wildcard if input nullptr.
out	<i>sock</i>	Pointer to the socket that, on success, returns the socket descriptor. The caller must release this socket with <a href="#">v2x_radio_sock_close()</a> .
out	<i>rx_sockaddr</i>	Pointer to the IPv6 UDP socket. The <code>sockaddr_in6</code> buffer is initialized with the IPv6 source address and source port that are used for the bind.

#### Detailed description

You can execute any sockopts that are appropriate for this type of socket (AF\_INET6).

This API can be used to subscribe wildcard, catchall port, or specific service IDs.

Wildcard is used to receive all traffic. Only one port can be registered as wildcard port. Once wildcard is registered successfully, all received packets will be directed to wildcard port, and any subscription for specific service IDs or catchall port at other ports will be invalid. The parameter `id_list` of this API should be set to a null list for wildcard subscription.

Catchall port is used to receive packets with non-registered service IDs (via specific service IDs subscription). Only one port can be registered as catchall port. If catchall port is registered successfully, received packets with non-registered service ID will be directed to catchall port. All specific service IDs subscription (if any) should be performed before catchall port subscription. The parameter `id_list` of this API should include all non-registered service IDs for catchall port subscription.

Any port different from catchall port can be used to receive packets with specific service IDs. Only one port can be registered for a single service ID, a list of service IDs can be registered at a single port. To

subscribe specific service IDs at a given Rx port, a Tx flow must be pre-setup with the Tx service ID set to any service ID included in the list of specific service IDs and the Tx source port set to the same port number as Rx port. The parameter `id_list` of this API should include all interested service IDs for the given Rx port.

### Returns

0 – On success.

Otherwise:

- `EPERM` – Socket creation failed; for more details, check `errno.h`.
- `EAFNOSUPPORT` – On failure to find the interface.
- `EACCES` – On failure to get the MAC address of the device.

### Dependencies

The interface must be pre-initialized with `v2x_radio_init()`. The handle from that function must be used as the parameter in this function. For any specific service ID subscription, a Tx flow must be pre-setup using one of the following methods:

- `v2x_radio_tx_sps_sock_create_and_bind()`
- `v2x_radio_tx_sps_sock_create_and_bind_v2()`
- `v2x_radio_tx_sps_only_create()`
- `v2x_radio_tx_sps_only_create_v2()`
- `v2x_radio_tx_event_sock_create_and_bind()`
- `v2x_radio_tx_event_sock_create_and_bind_v2()`
- `v2x_radio_tx_event_sock_create_and_bind_v3()`

#### 4.23.4.9 int v2x\_radio\_enable\_rx\_meta\_data ( v2x\_radio\_handle\_t handle, bool enable, int id\_list\_len, uint32\_t \* id\_list )

Enable or disable the meta data report for the packets corresponding to the service IDs.

If enabled, the meta data report would be generated in addition to the actual OTA payload packet, and it comes from the same data interface as the OTA packet itself, it consist of RF RSSI (received signal strength indicator) status, 32-bit SCI Format 1 (3GPP TS 36.213, section 14.1), packet delay estimation, L2 destination ID, and the resource blocks used for the packet's transmission: subframe, subchannel index.

On platforms with access control enabled, the caller needs to have TELUX\_CV2X\_INFO permission to successfully invoke this API.

##### Associated data types

[v2x\\_radio\\_handle\\_t](#)

##### Parameters

in	<i>handle</i>	Identifies the initialized Radio interface.
in	<i>enable</i>	enable or disable the meta data
in	<i>id_list_len</i>	number of the service IDs provided in the id_list
in	<i>id_list</i>	Pointer to the Rx service ID list

##### Detailed description

This function extracts the received packet's meta data from the payload, currently only NON-IP packets can have the meta data reported, it is not supported yet for IP packets.

If the meta data report is enabled for certain services, call [v2x\\_parse\\_rx\\_meta\\_data](#) to extract the meta data by providing a pointer to a object of type [rx\\_packet\\_meta\\_data\\_t](#), and the real payload.

##### Returns

0 – On success.

#### 4.23.4.10 int v2x\_radio\_sock\_create\_and\_bind ( v2x\_radio\_handle\_t handle, v2x\_tx\_sps\_flow\_info\_t \* tx\_flow\_info, v2x\_per\_sps\_reservation\_calls\_t \* calls, int tx\_sps\_portnum, int tx\_event\_portnum, int rx\_portnum, v2x\_sid\_list\_t \* rx\_id\_list, v2x\_sock\_info\_t \* tx\_sps\_sock, v2x\_sock\_info\_t \* tx\_event\_sock, v2x\_sock\_info\_t \* rx\_sock )

Creates Tx SPS socket, Tx Event socket and Rx socket with specified parameters. The socket is also bound as an AF\_INET6 UDP type socket.

This [v2x\\_radio\\_sock\\_create\\_and\\_bind\(\)](#) method is the combination of function [v2x\\_radio\\_tx\\_sps\\_sock\\_create\\_and\\_bind\\_v2\(\)](#)/[v2x\\_radio\\_tx\\_event\\_sock\\_create\\_and\\_bind\\_v2](#) in the transmit direction and function [v2x\\_radio\\_rx\\_sock\\_create\\_and\\_bind\\_v3\(\)](#) in the receiving direction.

On platforms with access control enabled, the caller needs to have TELUX\_CV2X\_FLOW\_OPS permission to successfully invoke this API.

**Associated data types**[v2x\\_radio\\_handle\\_t](#)**Parameters**

in	<i>handle</i>	Identifies the initialized Radio interface.
in	<i>tx_flow_info</i>	Pointer to the Tx SPS or event flow information. To create event flow, set reservation.v2xid and flow_info in this structure.
in	<i>calls</i>	Pointer to reservation callbacks or listeners. This parameter is called when underlying radio MAC parameters change related to the SPS bandwidth contract. For example, the callback after a reservation change, or if the timing offset of the SPS adjusts itself in response to traffic. This parameter passes NULL if no callbacks are required.
in	<i>tx_sps_portnum</i>	Requested Tx source port number for SPS transmissions, or -1 for no Tx sps flow.
in	<i>tx_event_portnum</i>	Requested Tx source port number for event transmissions, or -1 for no Tx event flow.
in	<i>rx_portnum</i>	Requested Rx destination port number, or -1 for no Rx subscription.
in	<i>rx_id_list</i>	Pointer to the Rx service ID list for subscription, subscribe wildcard if input nullptr.
out	<i>tx_sps_sock</i>	Pointer to the Tx sps socket that, on success, returns the socket descriptor and the IPv6 socket address. The caller must release this socket with <a href="#">v2x_radio_sock_close()</a> .
out	<i>tx_event_sock</i>	Pointer to the Tx event socket that, on success, returns the socket descriptor and the IPv6 socket address. The caller must release this socket with <a href="#">v2x_radio_sock_close()</a> .
out	<i>rx_sock</i>	Pointer to the Rx socket that, on success, returns the socket descriptor and the IPv6 socket address. The caller must release this socket with <a href="#">v2x_radio_sock_close()</a> .

**Detailed description**

You can execute any sockopts that are appropriate for this type of socket (AF\_INET6).

This API can be used for the registration of both Tx and Rx. It sets up sockets on the requested port numbers. A negative port number corresponds to no actions for Tx or Rx.

Wildcard is used to receive all traffic. Only one port can be registered as wildcard port. Once wildcard is registered successfully, all received packets will be directed to wildcard port, and any subscription for specific service IDs or catchall port at other ports will be invalid. The parameter rx\_id\_list of this API should be set to a null list for wildcard subscription.

Catchall port is used to receive packets with non-registered service IDs (via specific service IDs subscription). Only one port can be registered as catchall port. If catchall port is registered successfully, received packets with non-registered service ID will be directed to catchall port. All specific service IDs subscription (if any) should be performed before catchall port subscription. The parameter rx\_id\_list of this API should include all non-registered service IDs for catchall port subscription.

Any port different from catchall port can be used to receive packets with specific service IDs. Only one port can be registered for a single service ID, a list of service IDs can be registered at a single port. To subscribe specific service IDs at a given Rx port, a Tx flow should also be set up using this API. The parameter `rx_id_list` should include all interested service IDs for the given Rx port, the parameter `tx_flow_info.reservation.v2xid` should be set to one of the service ID included in `rx_id_list`, the parameter `tx_sps_portnum` or `tx_event_portnum` should be set to the same port number as `rx_portnum`.

### Returns

0 – On success.

Otherwise:

- EPERM – Socket creation failed; for more details, check `errno.h`.
- EAFNOSUPPORT – On failure to find the interface.
- EACCES – On failure to get the MAC address of the device.

### Dependencies

The interface must be pre-initialized with `v2x_radio_init()`. The handle from that function must be used as the parameter in this function.

**4.23.4.11** `int v2x_radio_tx_sps_sock_create_and_bind ( v2x_radio_handle_t handle, v2x_tx_bandwidth_reservation_t * res, v2x_per_sps_reservation_calls_t * calls, int sps_portnum, int event_portnum, int * sps_sock, struct sockaddr_in6 * sps_sockaddr, int * event_sock, struct sockaddr_in6 * event_sockaddr )`

Creates and binds a socket with a bandwidth-reserved (SPS) Tx flow with the requested ID, priority, periodicity, and size on a specified source port number. The socket is created as an IPv6 UDP socket.

On platforms with access control enabled, the caller needs to have TELUX\_CV2X\_FLOW\_OPS permission to successfully invoke this API.

#### Associated data types

[v2x\\_radio\\_handle\\_t](#)  
[v2x\\_tx\\_bandwidth\\_reservation\\_t](#)  
[v2x\\_per\\_sps\\_reservation\\_calls\\_t](#)

#### Parameters

in	<i>handle</i>	Identifies the initialized Radio interface on which this data connection is made.
in	<i>res</i>	Pointer to the parameter structure (how often the structure is sent, how many bytes are reserved, and so on).
in	<i>calls</i>	Pointer to reservation callbacks or listeners. This parameter is called when underlying radio MAC parameters change related to the SPS bandwidth contract. For example, the callback after a reservation change, or if the timing offset of the SPS adjusts itself in response to traffic. This parameter passes NULL if no callbacks are required.
in	<i>sps_portnum</i>	Requested source port number for the bandwidth reserved SPS transmissions.
in	<i>event_portnum</i>	Requested source port number for the bandwidth reserved event transmissions, or -1 for no event port.
out	<i>sps_sock</i>	Pointer to the socket that is bound to the requested port for Tx with reserved bandwidth.
out	<i>sps_sockaddr</i>	Pointer to the IPv6 UDP socket. The sockaddr_in6 buffer is initialized with the IPv6 source address and source port that are used for the bind() function. The caller can then use the buffer for subsequent sendto() function calls.
out	<i>event_sock</i>	Pointer to the socket that is bound to the event-driven transmission port.
out	<i>event_sockaddr</i>	Pointer to the IPV6 UDP socket. The sockaddr_in6 buffer is initialized with the IPv6 source address and source port that are used for the bind() function. The caller can then use the buffer for subsequent sendto() function calls.



## Detailed description

The radio attempts to reserve the flow with the specified size and rate passed in the request parameters.

This function is used only for Tx. It sets up two UDP sockets on the requested two HLOS port numbers.

For only a single SPS flow, indicate the event port number by using a negative number or NULL for the event\_sockaddr. For a single event-driven port, use [v2x\\_radio\\_tx\\_event\\_sock\\_create\\_and\\_bind\(\)](#) instead.

Because the modem endpoint requires a specific global address, all data sent on these sockets must have a configurable IPv6 destination address for the non-IP traffic.

The Priority parameter of the SPS reservation is used only for the reserved Tx bandwidth (SPS) flow. The non-SPS/event-driven data sent to the event\_portnum parameter is prioritized on the air, based on the IPv6 Traffic Class of the packet.

The caller is expected to identify two unused local port numbers to use for binding: one for the event-driven flow and one for the SPS flow.

This call is a blocking call. When it returns, the sockets are ready to use, assuming there is no error.

## Returns

0 – On success.

Otherwise:

- EPERM – Socket creation failed; for more details, check errno.h.
- EAFNOSUPPORT – On failure to find the interface.
- EACCES – On failure to get the MAC address of the device.

## Dependencies

The interface must be pre-initialized with [v2x\\_radio\\_init\(\)](#) or [v2x\\_radio\\_init\\_v2\(\)](#). The handle from that function must be used as the parameter in this function.

#### 4.23.4.12 `int v2x_radio_tx_sps_only_create ( v2x_radio_handle_t handle, v2x_tx_↔ bandwidth_reservation_t * res, v2x_per_sps_reservation_calls_t * calls, int sps_portnum, int * sps_sock, struct sockaddr_in6 * sps_sockaddr )`

Creates a socket with a bandwidth-reserved (SPS) Tx flow.

Only SPS transmissions are to be implemented for the socket, which is created as an IPv6 UDP socket.

On platforms with access control enabled, the caller needs to have TELUX\_CV2X\_FLOW\_OPS permission to successfully invoke this API.

#### Associated data types

[v2x\\_radio\\_handle\\_t](#)  
[v2x\\_tx\\_bandwidth\\_reservation\\_t](#)  
[v2x\\_per\\_sps\\_reservation\\_calls\\_t](#)

#### Parameters

in	<i>handle</i>	Identifies the initialized Radio interface on which this data connection is made.
in	<i>res</i>	Pointer to the parameter structure (how often the structure is sent, how many bytes are reserved, and so on).
in	<i>calls</i>	Pointer to reservation callbacks or listeners. This parameter is called when underlying radio MAC parameters change related to the SPS bandwidth contract. For example, the callback after a reservation change, or if the timing offset of the SPS adjusts itself in response to traffic. This parameter passes NULL if no callbacks are required.
in	<i>sps_portnum</i>	Requested source port number for the bandwidth reserved SPS transmissions.
out	<i>sps_sock</i>	Pointer to the socket that is bound to the requested port for Tx with reserved bandwidth.
out	<i>sps_sockaddr</i>	Pointer to the IPv6 UDP socket. The <code>sockaddr_in6</code> buffer is initialized with the IPv6 source address and source port that are used for the <code>bind()</code> function. The caller can then use the buffer for subsequent <code>sendto()</code> function calls.

#### Detailed description

The radio attempts to reserve the flow with the specified size and rate passed in the request parameters.

This function is used only for Tx. It sets up a UDP socket on the requested HLOS port number.

Because the modem endpoint requires a specific global address, all data sent on the socket must have a configurable IPv6 destination address for the non-IP traffic.

The Priority parameter of the SPS reservation is used only for the reserved Tx bandwidth (SPS) flow.

The caller is expected to identify an unused local port number for the SPS flow.

This call is a blocking call. When it returns, the socket is ready to use, assuming there is no error.

**Returns**

0 – On success.

Otherwise:

- EPERM – Socket creation failed; for more details, check `errno.h`.
- EINVAL – On failure to find the interface or get bad parameters.

**Dependencies**

The interface must be pre-initialized with `v2x_radio_init()` or `v2x_radio_init_v2()`. The handle from that function must be used as the parameter in this function.

#### 4.23.4.13 `v2x_status_enum_type v2x_radio_tx_reservation_change ( int * sps_sock, v2x_tx_bandwidth_reservation_t * updated_reservation )`

Adjusts the reservation for transmit bandwidth.

##### Associated data types

[v2x\\_tx\\_bandwidth\\_reservation\\_t](#)

##### Parameters

out	<i>sps_sock</i>	Pointer to the socket bound to the requested port.
in	<i>updated_reservation</i>	Pointer to a bandwidth reservation with new reservation information.

On platforms with access control enabled, the caller needs to have `TELUX_CV2X_FLOW_OPS` permission to successfully invoke this API.

##### Detailed description

This function will not update reservation priority. Can be used as follows:

- When the bandwidth requirement changes in periodicity (for example, due to an application layer DCC algorithm)
- Because the packet size is increasing (for example, due to a growing path history size in a BSM).

When the reservation change is complete, a callback to the structure is passed in a `v2x_radio_init()` or `v2x_radio_init_v2()` call.

##### Returns

[V2X\\_STATUS\\_SUCCESS](#).

Error code – If there is a problem (see [v2x\\_status\\_enum\\_type](#)).

##### Dependencies

An SPS flow must have been successfully initialized with the [v2x\\_radio\\_tx\\_sps\\_sock\\_create\\_and\\_bind\(\)](#).

#### 4.23.4.14 `int v2x_radio_tx_event_sock_create_and_bind ( const char * interface, int v2x_id, int event_portnum, struct sockaddr_in6 * event_sock_addr, int * sock )`

Opens and binds an event-driven socket (one with no bandwidth reservation). The socket is bound as an AF\_INET6 UDP type socket.

On platforms with access control enabled, the caller needs to have TELUX\_CV2X\_FLOW\_OPS permission to successfully invoke this API.

##### Parameters

in	<i>interface</i>	Pointer to the operating system name to use. This interface is an RmNet interface (HLOS).
in	<i>v2x_id</i>	Used for transmissions that are ultimately mapped to an L2 destination address.
in	<i>event_portnum</i>	Local port number to which the socket is bound. Used for transmissions of this ID.
out	<i>event_sock_addr</i>	Pointer to the sockaddr_ll structure buffer to be initialized.
out	<i>sock</i>	Pointer to the file descriptor. Loaded when the function is successful.

##### Detailed description

This function is used only for Tx when no periodicity is available for the application type. If you know your transmit data periodicity, use [v2x\\_radio\\_tx\\_sps\\_sock\\_create\\_and\\_bind\(\)](#) instead.

These event-driven sockets pay attention to QoS parameters in the IP socket.

##### Returns

0 – On success.

Otherwise:

- EPERM – Socket creation failed; for more details, check errno.h.
- EAFNOSUPPORT – On failure to find the interface.
- EACCES – On failure to get the MAC address of the device.

#### 4.23.4.15 `v2x_status_enum_type v2x_radio_start_measurements ( v2x_radio_↔ _handle_t handle, v2x_chan_meas_params_t * measure_this_way )`

Requests a channel utilization (CBP/CBR) measurement result on a channel.

##### Associated data types

[v2x\\_radio\\_handle\\_t](#)

[v2x\\_chan\\_meas\\_params\\_t](#)

##### Parameters

in	<i>handle</i>	Handle to the port.
in	<i>measure_this_way</i>	Indicates how and what to measure, and how often to send results. Some higher-level standards (like J2945/1 and ETSI TS102687 DCC) have specific time windows and items to measure.

##### Detailed description

This function uses the callbacks passed in during initialization to deliver the measurements. Measurement callbacks continue until the Radio interface is closed.

##### Returns

[V2X\\_STATUS\\_SUCCESS](#) – The radio is now ready for data-plane sockets to be created and bound.

[V2X\\_STATUS\\_FAIL](#) – CBR measurement is not supported yet.

##### Dependencies

The interface must be pre-initialized with `v2x_radio_init()` or `v2x_radio_init_v2()`. The handle from that function must be used as the parameter in this function.

#### 4.23.4.16 `v2x_status_enum_type v2x_radio_stop_measurements ( v2x_radio_handle_t handle )`

Discontinues any periodic MAC/Phy channel measurements and the reporting of them via listener calls.

##### Associated data types

[v2x\\_radio\\_handle\\_t](#)

##### Parameters

in	<i>handle</i>	Handle to the radio measurements to be stopped.
----	---------------	---

##### Returns

[V2X\\_STATUS\\_SUCCESS](#).

##### Dependencies

The measurements must have been started with [v2x\\_radio\\_start\\_measurements\(\)](#).

#### 4.23.4.17 int v2x\_radio\_sock\_close ( int \* sock\_fd )

Closes a specified socket file descriptor and deregisters any modem resources associated with it (such as reserved SPS bandwidth contracts).

On platforms with access control enabled, the caller needs to have TELUX\_CV2X\_FLOW\_OPS permission to successfully invoke this API.

##### Parameters

in	<i>sock_fd</i>	Socket file descriptor.
----	----------------	-------------------------

##### Detailed description

This function works on receive, SPS, or event-driven sockets.

The socket file descriptor must be closed when the client exits. We recommend using a trap to catch controlled shutdowns.

##### Returns

Integer value of the close(sock) operation.

##### Dependencies

The socket must have been opened with one of the following methods:

- [v2x\\_radio\\_rx\\_sock\\_create\\_and\\_bind\(\)](#)
- [v2x\\_radio\\_tx\\_sps\\_sock\\_create\\_and\\_bind\(\)](#)
- [v2x\\_radio\\_tx\\_sps\\_sock\\_create\\_and\\_bind\\_v2\(\)](#)
- [v2x\\_radio\\_tx\\_sps\\_only\\_create\(\)](#)
- [v2x\\_radio\\_tx\\_sps\\_only\\_create\\_v2\(\)](#)
- [v2x\\_radio\\_tx\\_event\\_sock\\_create\\_and\\_bind\(\)](#)
- [v2x\\_radio\\_tx\\_event\\_sock\\_create\\_and\\_bind\\_v2\(\)](#)
- [v2x\\_radio\\_tx\\_event\\_sock\\_create\\_and\\_bind\\_v3\(\)](#)



**4.23.4.18 void v2x\_radio\_set\_log\_level ( int *new\_level*, int *use\_syslog* )**

Configures the V2X log level and destination for SDK and lower layers.

**Parameters**

in	<i>new_level</i>	Log level to set to one of the standard syslog levels (LOG_ERR, LOG_INFO, and so on).
in	<i>use_syslog</i>	Destination: send to stdout (0) or syslog (otherwise).

**Returns**

None.

**4.23.4.19 v2x\_event\_t cv2x\_status\_poll ( uint64\_t \* *status\_age\_useconds* )**

Polls for the recent V2X status.

**Parameters**

out	<i>status_age_useconds</i>	Pointer to the age in microseconds of the last event (radio status) that is being reported.
-----	----------------------------	---

**Detailed description**

This function does not generate any modem control traffic. For efficiency, it simply returns the most recently cached value that was reported from the modem (often reported at a high rate or frequent rate from the modem).

**Returns**

Indication of success or failure (see [v2x\\_status\\_enum\\_type](#)).

#### 4.23.4.20 int v2x\_radio\_trigger\_l2\_update ( v2x\_radio\_handle\_t *handle* )

Triggers the modem to change its source L2 address by randomly generating a new address.

On platforms with access control enabled, the caller needs to have TELUX\_CV2X\_CONFIG permission to successfully invoke this API.

##### Associated data types

[v2x\\_radio\\_handle\\_t](#)

##### Parameters

in	<i>handle</i>	Initialized Radio interface on which this data connection is made.
----	---------------	--

##### Detailed description

When the change is complete, clients are notified of the new L2 address via the [v2x\\_radio\\_calls\\_t::v2x\\_radio\\_l2\\_addr\\_changed\\_listener\(\)](#) callback function.

##### Returns

0 – On success.

Otherwise:

- EPERM – Socket creation failed; for more details, check errno.h.
- EAFNOSUPPORT – On failure to find the interface.
- EACCES – On failure to get the MAC address of the device.

**4.23.4.21** `int v2x_radio_update_trusted_ue_list ( unsigned int malicious_list_len, unsigned int malicious_list[MAX_MALICIOUS_IDS_LIST_LEN], unsigned int trusted_list_len, trusted_ue_info_t trusted_list[MAX_TRUSTED_IDS_LIST_LEN] )`

Updates the list of malicious and trusted IDs tracked by the modem.

On platforms with access control enabled, the caller needs to have TELUX\_CV2X\_CONFIG permission to successfully invoke this API.

#### Associated data types

[trusted\\_ue\\_info\\_t](#)

#### Parameters

in	<i>malicious_list_len</i>	Number of malicious IDs in <i>malicious_list</i> .
in	<i>malicious_list</i>	List of malicious IDs.
in	<i>trusted_list_len</i>	Number of trusted IDs in <i>trusted_list</i> .
in	<i>trusted_list</i>	List of trusted IDs.

#### Returns

0 – On success.

Otherwise:

- EPERM – Socket creation failed; for more details, check `errno.h`.
- EAFNOSUPPORT – On failure to find the interface.
- EACCES – On failure to get the MAC address of the device.

**4.23.4.22** `int v2x_radio_tx_sps_sock_create_and_bind_v2 ( v2x_radio_handle_t handle, v2x_tx_sps_flow_info_t * sps_flow_info, v2x_per_sps_reservation_calls_t * calls, int sps_portnum, int event_portnum, int * sps_sock, struct sockaddr_in6 * sps_sockaddr, int * event_sock, struct sockaddr_in6 * event_sockaddr )`

Creates and binds a socket with a bandwidth-reserved (SPS) Tx flow with the requested ID, priority, periodicity, and size on a specified source port number. The socket is created as an IPv6 UDP socket.

This `v2x_radio_tx_sps_sock_create_and_bind_v2()` method differs from `v2x_radio_tx_sps_sock_create_and_bind()` in that you can use the `sps_flow_info` parameter to specify transmission resource information about the Tx flow.

On platforms with access control enabled, the caller needs to have `TELUX_CV2X_FLOW_OPS` permission to successfully invoke this API.

#### Associated data types

[v2x\\_radio\\_handle\\_t](#)  
[v2x\\_tx\\_sps\\_flow\\_info\\_t](#)  
[v2x\\_per\\_sps\\_reservation\\_calls\\_t](#)

#### Parameters

in	<i>handle</i>	Identifies the initialized Radio interface on which this data connection is made.
in	<i>sps_flow_info</i>	Pointer to the flow information in the <a href="#">v2x_tx_sps_flow_info_t</a> structure.
in	<i>calls</i>	Pointer to reservation callbacks or listeners. This parameter is called when underlying radio MAC parameters change related to the SPS bandwidth contract. For example, the callback after a reservation change, or if the timing offset of the SPS adjusts itself in response to traffic. This parameter passes NULL if no callbacks are required.
in	<i>sps_portnum</i>	Requested source port number for the bandwidth reserved SPS transmissions.
in	<i>event_portnum</i>	Requested source port number for the bandwidth reserved event transmissions, or -1 for no event port.
out	<i>sps_sock</i>	Pointer to the socket that is bound to the requested port for Tx with reserved bandwidth.
out	<i>sps_sockaddr</i>	Pointer to the IPv6 UDP socket. The <code>sockaddr_in6</code> buffer is initialized with the IPv6 source address and source port that are used for the <code>bind()</code> function. The caller can then use the buffer for subsequent <code>sendto()</code> function calls.
out	<i>event_sock</i>	Pointer to the socket that is bound to the event-driven transmission port.

out	<i>event_sockaddr</i>	Pointer to the IPV6 UDP socket. The sockaddr_in6 buffer is initialized with the IPv6 source address and source port that are used for the bind() function. The caller can then use the buffer for subsequent sendto() function calls.
-----	-----------------------	--

## Detailed description

The radio attempts to reserve the flow with the specified size and rate passed in the request parameters.

This function is used only for Tx. It sets up two UDP sockets on the requested two HLOS port numbers.

For only a single SPS flow, indicate the event port number by using a negative number or NULL for the event\_sockaddr. For a single event-driven port, use [v2x\\_radio\\_tx\\_event\\_sock\\_create\\_and\\_bind\(\)](#) or [v2x\\_radio\\_tx\\_event\\_sock\\_create\\_and\\_bind\\_v2\(\)](#) or [v2x\\_radio\\_tx\\_event\\_sock\\_create\\_and\\_bind\\_v3\(\)](#) instead.

Because the modem endpoint requires a specific global address, all data sent on these sockets must have a configurable IPv6 destination address for the non-IP traffic.

The Priority parameter of the SPS reservation is used only for the reserved Tx bandwidth (SPS) flow. The non-SPS/event-driven data sent to the event\_portnum parameter is prioritized on the air, based on the IPv6 Traffic Class of the packet.

The caller is expected to identify two unused local port numbers to use for binding: one for the event-driven flow and one for the SPS flow.

This call is a blocking call. When it returns, the sockets are ready to use, assuming there is no error.

## Returns

0 – On success.

Otherwise:

- EPERM – Socket creation failed; for more details, check errno.h.
- EAFNOSUPPORT – On failure to find the interface.
- EACCES – On failure to get the MAC address of the device.

## Dependencies

The interface must be pre-initialized with [v2x\\_radio\\_init\(\)](#) or [v2x\\_radio\\_init\\_v2\(\)](#). The handle from that function must be used as the parameter in this function.

**4.23.4.23** `int v2x_radio_tx_sps_only_create_v2 ( v2x_radio_handle_t handle, v2x_tx_sps_flow_info_t * sps_flow_info, v2x_per_sps_reservation_calls_t * calls, int sps_portnum, int * sps_sock, struct sockaddr_in6 * sps_sockaddr )`

Creates a socket with a bandwidth-reserved (SPS) Tx flow.

Only SPS transmissions are to be implemented for the socket, which is created as an IPv6 UDP socket.

This `v2x_radio_tx_sps_only_create_v2()` method differs from `v2x_radio_tx_sps_only_create()` in that you can use the `sps_flow_info` parameter to specify transmission resource information about the Tx flow.

On platforms with access control enabled, the caller needs to have `TELUX_CV2X_FLOW_OPS` permission to successfully invoke this API.

#### Associated data types

[v2x\\_radio\\_handle\\_t](#)  
[v2x\\_tx\\_sps\\_flow\\_info\\_t](#)  
[v2x\\_per\\_sps\\_reservation\\_calls\\_t](#)

#### Parameters

in	<i>handle</i>	Identifies the initialized Radio interface on which this data connection is made.
in	<i>sps_flow_info</i>	Pointer to the flow information in the <a href="#">v2x_tx_sps_flow_info_t</a> structure.
in	<i>calls</i>	Pointer to reservation callbacks or listeners. This parameter is called when underlying radio MAC parameters change related to the SPS bandwidth contract. For example, the callback after a reservation change, or if the timing offset of the SPS adjusts itself in response to traffic. This parameter passes NULL if no callbacks are required.
in	<i>sps_portnum</i>	Requested source port number for the bandwidth reserved SPS transmissions.
out	<i>sps_sock</i>	Pointer to the socket that is bound to the requested port for Tx with reserved bandwidth.
out	<i>sps_sockaddr</i>	Pointer to the IPv6 UDP socket. The <code>sockaddr_in6</code> buffer is initialized with the IPv6 source address and source port that are used for the <code>bind()</code> function. The caller can then use the buffer for subsequent <code>sendto()</code> function calls.

#### Detailed description

The radio attempts to reserve the flow with the specified size and rate passed in the request parameters.

This function is used only for Tx. It sets up a UDP socket on the requested HLOS port number.

Because the modem endpoint requires a specific global address, all data sent on the socket must have a configurable IPv6 destination address for the non-IP traffic.

The caller is expected to identify an unused local port number to use for binding the SPS flow.

This call is a blocking call. When it returns, the socket is ready to use, assuming there is no error.



**Returns**

0 – On success.

Otherwise:

- EPERM – Socket creation failed; for more details, check `errno.h`.
- EINVAL – On failure to find the interface or get bad parameters.

**Dependencies**

The interface must be pre-initialized with `v2x_radio_init()` or `v2x_radio_init_v2()`. The handle from that function must be used as the parameter in this function.

#### 4.23.4.24 `v2x_status_enum_type v2x_radio_tx_reservation_change_v2 ( int * sps_sock, v2x_tx_sps_flow_info_t * updated_flow_info )`

Adjusts the reservation for transmit bandwidth.

This `v2x_radio_tx_reservation_change_v2()` method differs from `v2x_radio_tx_reservation_change()` in that you can use the `updated_flow_info` parameter to specify transmission resource information about the Tx flow.

On platforms with access control enabled, the caller needs to have `TELUX_CV2X_FLOW_OPS` permission to successfully invoke this API.

##### Associated data types

[v2x\\_tx\\_sps\\_flow\\_info\\_t](#)

##### Parameters

out	<code>sps_sock</code>	Pointer to the socket bound to the requested port.
in	<code>updated_flow_info</code>	Pointer to the new reservation information.

##### Detailed description

This function will not update reservation priority. Can be used as follows:

- When the bandwidth requirement changes in periodicity (for example, due to an application layer DCC algorithm)
- Because the packet size is increasing (for example, due to a growing path history size in a BSM).

When the reservation change is complete, a callback to the structure is passed in a `v2x_radio_init()` or `v2x_radio_init_v2()` call.

##### Returns

[V2X\\_STATUS\\_SUCCESS](#).

Error code – On failure (see [v2x\\_status\\_enum\\_type](#)).

##### Dependencies

An SPS flow must have been successfully initialized with `v2x_radio_tx_sps_sock_create_and_bind()` or `v2x_radio_tx_sps_sock_create_and_bind_v2()`.

#### 4.23.4.25 `v2x_status_enum_type v2x_radio_tx_event_flow_info_change ( int * sock, v2x_tx_flow_info_t * updated_flow_info )`

Adjusts the flow parameters for an existing Tx event socket.

On platforms with access control enabled, the caller needs to have TELUX\_CV2X\_CONFIG permission to successfully invoke this API.

##### Associated data types

[v2x\\_tx\\_flow\\_info\\_t](#)

##### Parameters

out	<i>sock</i>	Pointer to the socket bound to the requested port.
in	<i>updated_flow_info</i>	Pointer to the new flow parameters.

##### Detailed description

When the reservation change is complete, a callback to the structure is passed in a [v2x\\_radio\\_init\(\)](#) or [v2x\\_radio\\_init\\_v2\(\)](#) call.

This call is a blocking call. When it returns, the socket is ready to be use, assuming there is no error.

##### Returns

[V2X\\_STATUS\\_SUCCESS](#).

Error code – On failure (see [v2x\\_status\\_enum\\_type](#)).

##### Dependencies

An event flow must have been successfully initialized with [v2x\\_radio\\_tx\\_event\\_socket\\_create\\_and\\_bind\(\)](#) or [v2x\\_radio\\_tx\\_event\\_socket\\_create\\_and\\_bind\\_v2\(\)](#) or [v2x\\_radio\\_tx\\_event\\_socket\\_create\\_and\\_bind\\_v3\(\)](#).

#### 4.23.4.26 `v2x_status_enum_type start_v2x_mode ( )`

Starts V2X mode.

The V2X radio status must be INACTIVE. If the status is ACTIVE or SUSPENDED (see [v2x\\_event\\_t](#)), call [stop\\_v2x\\_mode\(\)](#) first.

This call is a blocking call. When it returns, V2X mode has been started, assuming there is no error.

On platforms with access control enabled, the caller needs to have TELUX\_CV2X\_OPS permission to successfully invoke this API.

##### Returns

[V2X\\_STATUS\\_SUCCESS](#).

Otherwise:

- [V2X\\_STATUS\\_EALREADY](#) – Failure because V2X mode is already started.
- [V2X\\_STATUS\\_FAIL](#) – Other failure.

##### Dependencies

V2X radio status must be [V2X\\_INACTIVE](#) ([v2x\\_event\\_t](#)).

#### 4.23.4.27 `v2x_status_enum_type stop_v2x_mode ( )`

Stops V2X mode.

The V2X radio status must be ACTIVE or SUSPENDED (see [v2x\\_event\\_t](#)). If the status is INACTIVE, call [start\\_v2x\\_mode\(\)](#) first.

This call is a blocking call. When it returns, V2X mode has been stopped, assuming there is no error.

On platforms with access control enabled, the caller needs to have TELUX\_CV2X\_OPS permission to successfully invoke this API.

##### Returns

[V2X\\_STATUS\\_SUCCESS](#).

Otherwise:

- [V2X\\_STATUS\\_EALREADY](#) – Failure because V2X mode is already stopped.
- [V2X\\_STATUS\\_FAIL](#) – Other failure.

##### Dependencies

V2X radio status must be [V2X\\_ACTIVE](#), [V2X\\_TX\\_SUSPENDED](#), [V2X\\_RX\\_SUSPENDED](#), or [V2X\\_TXRX\\_SUSPENDED](#).

**4.23.4.28 v2x\_radio\_handle\_t v2x\_radio\_init\_v2 ( traffic\_ip\_type\_t ip\_type, v2x\_concurrency\_sel\_t mode, v2x\_radio\_calls\_t \* callbacks\_p, void \* ctx\_p )**

### Deprecated

This API has been deprecated. Please use [v2x\\_radio\\_init\\_v3\(\)](#) instead.

Initializes the Radio interface and sets the callback that will be used when events in the radio change (including when radio initialization is complete).

### Associated data types

[traffic\\_ip\\_type\\_t](#)  
[v2x\\_concurrency\\_sel\\_t](#)  
[v2x\\_radio\\_calls\\_t](#)

### Parameters

in	<i>ip_type</i>	The Ip or non-IP interface.
in	<i>mode</i>	WAN concurrency mode, although the radio might not support concurrency. Errors can be generated.
in	<i>callbacks_p</i>	Pointer to the <a href="#">v2x_radio_calls_t</a> structure that is prepopulated with function pointers used during radio events (such as loss of time synchronization or accuracy) for subscribers. This parameter also points to a callback for this initialization function.
in	<i>ctx_p</i>	Voluntary pointer to the first parameter on the callback.

### Detailed description

This function call is a blocking, and it is a control plane action.

Use [v2x\\_radio\\_deinit\(\)](#) when radio operations are complete.

Callback is made when initialization is complete.

### Returns

Handle to the specified initialized radio. The handle is used for reconfiguring, opening or changing, and closing reservations.

[V2X\\_RADIO\\_HANDLE\\_BAD](#) – If there is an error. No initialization callback is made.

**4.23.4.29** `int v2x_radio_init_v3 ( v2x_concurrency_sel_t mode, v2x_radio_calls_t * callbacks_p, void * ctx_p, v2x_radio_handle_t * ip_handle_p, v2x_radio_handle_t * non_ip_handle_p )`

Initializes Cv2x radio and sets the callback that will be used when events in the radio change (including when radio initialization is complete). The callers can get the handles of Cv2x IP and non-IP interface on success. The handle of interface is used for reconfiguring, opening or changing, and closing reservations.

#### Associated data types

[v2x\\_concurrency\\_sel\\_t](#)  
[v2x\\_radio\\_calls\\_t](#)

#### Parameters

in	<i>mode</i>	WAN concurrency mode, although the radio might not support concurrency. Errors can be generated.
in	<i>callbacks_p</i>	Pointer to the <a href="#">v2x_radio_calls_t</a> structure that is prepopulated with function pointers used during radio events (such as loss of time synchronization or accuracy) for subscribers. This parameter also points to a callback for this initialization function.
in	<i>ctx_p</i>	Voluntary pointer to the first parameter on the callback.
out	<i>ip_handle_p</i>	Pointer to the handle of IP interface. Pass nullptr if IP interface is not used.
out	<i>non_ip_handle_p</i>	Pointer to the handle of non-IP interface. Pass nullptr if non-IP interface is not used.

#### Detailed description

This function call is a blocking, and it is a control plane action.

Use [v2x\\_radio\\_deinit\(\)](#) with either IP or non-IP handle when radio operations are complete.

Callback is made when initialization is complete.

#### Returns

0 – On success.

Otherwise:

- EINVAL – Invalid input parameters.
- EPERM – Radio initialization failed.

#### Dependencies

This API might fail if the underlying Cv2x status is currently in an inactive state. Use [v2x\\_register\\_ext\\_radio\\_status\\_listener](#) to register a listener for CV2X overall Tx/Rx status, then use [v2x\\_get\\_ext\\_radio\\_status](#) to get current V2X overall radio status.

#### 4.23.4.30 `int v2x_radio_tx_event_sock_create_and_bind_v3 ( traffic_ip_type_t ip_type, int v2x_id, int event_portnum, v2x_tx_flow_info_t * event_flow_info, struct sockaddr_in6 * event_sockaddr, int * sock )`

Opens and binds an event-driven socket (one with no bandwidth reservation). The socket is bound as an AF\_INET6 UDP type socket.

On platforms with access control enabled, the caller needs to have TELUX\_CV2X\_FLOW\_OPS permission to successfully invoke this API.

This `v2x_radio_tx_event_sock_create_and_bind_v3()` method differs from `v2x_radio_tx_event_sock_create_and_bind_v2()` in that you can use the `traffic_ip_type_t` parameter to specify traffic ip type instead of requiring the interface name.

#### Associated data types

[v2x\\_tx\\_flow\\_info\\_t](#) [traffic\\_ip\\_type\\_t](#)

#### Parameters

in	<i>ip_type</i>	<code>traffic_ip_type</code> .
in	<i>v2x_id</i>	Used for transmissions that are ultimately mapped to an L2 destination address.
in	<i>event_portnum</i>	Local port number to which the socket is bound. Used for transmissions of this ID.
in	<i>event_flow_info</i>	Pointer to the event flow parameters.
out	<i>event_sockaddr</i>	Pointer to the <code>sockaddr_ll</code> structure buffer to be initialized.
out	<i>sock</i>	Pointer to the file descriptor. Loaded when the function is successful.

#### Detailed description

This function is used only for Tx when no periodicity is available for the application type. If you know your transmit data periodicity, use `v2x_radio_tx_sps_sock_create_and_bind()` or `v2x_radio_tx_sps_sock_create_and_bind_v2()` instead.

These event-driven sockets pay attention to QoS parameters in the IP socket.

#### Returns

0 – On success.

Otherwise:

- EPERM – Socket creation failed; for more details, check `errno.h`.
- EAFNOSUPPORT – On failure to find the interface.
- EACCES – On failure to get the MAC address of the device.

#### 4.23.4.31 v2x\_status\_enum\_type get\_iface\_name ( traffic\_ip\_type\_t *ip\_type*, char \* *iface\_name*, size\_t *buffer\_len* )

Returns interface name set during radio initialization.

##### Associated data types

traffic\_ip\_type\_t

##### Parameters

in	<i>ip_type</i>	traffic_ip_type_t
out	<i>iface_name</i>	pointer to buffer for interface name
in	<i>buffer_len</i>	length of the buffer passed for interface name. Must be at least the max buffer size for an interface name (IFNAMSIZE).

##### Detailed description

This function should only be called after successfully initializing a radio.

##### Returns

[V2X\\_STATUS\\_SUCCESS](#).

[V2X\\_STATUS\\_FAIL](#) – If there is an error. Interface name will be an empty string.



#### 4.23.4.32 `int v2x_radio_tcp_sock_create_and_bind ( v2x_radio_handle_t handle, const v2x_tx_flow_info_t * event_info, const socket_info_t * sock_info, int * sock_fd, struct sockaddr_in6 * sockaddr )`

Creates a TCP socket for event Tx and Rx. The socket is bound as an AF\_INET6 TCP type socket.

This `v2x_radio_tcp_sock_create_and_bind()` API creates a new TCP socket and binds the socket to the IPv6 address of local IP interface with specified source port. Additionally, this API also registers a Tx event flow and subscribes Rx with specified service ID to enable TCP control and data packets in both transmitting and receiving directions.

On platforms with access control enabled, the caller needs to have `TELUX_CV2X_FLOW_OPS` permission to successfully invoke this API.

If the created socket is expected to work as TCP client mode, the caller must establish a connection to the address specified using function `connect()`, and then use the socket for `send()` and `recv()` on successful connection. The caller must release the created socket and associated resources with `v2x_radio_sock_close()`.

If the created socket is expected to work as TCP server mode, the caller must mark the created socket as a listening socket with function `listen()`, that is, as a socket that will be used to accept incoming connection requests using `accept()`. The caller can then use the connected socket returned by `accept()` for `send()` and `recv()`. The caller must close all connected sockets returned by `accept()` with function `close()` first, and then release the listening socket and associated resources with `v2x_radio_sock_close()`.

This call is a blocking call. When it returns, the created TCP socket is ready to use, assuming there is no error.

#### Associated data types

[v2x\\_radio\\_handle\\_t](#)

#### Parameters

in	<i>handle</i>	Identifies the initialized Radio interface. The caller must specify IP interface for radio initialization.
in	<i>event_info</i>	Pointer to the Tx event flow information.
in	<i>sock_info</i>	Pointer to the TCP socket information.
out	<i>sock_fd</i>	Pointer to the socket that, on success, returns the TCP socket descriptor. The caller must release this socket with <a href="#">v2x_radio_sock_close()</a> .
out	<i>sockaddr</i>	Pointer to the address of TCP socket. The <code>sockaddr_in6</code> buffer is initialized with the IPv6 source address and source port that are used for the bind.

#### Detailed description

You can execute any socket ops that are appropriate for this type of socket (AF\_INET6).

**Returns**

0 – On success.

Otherwise:

- EINVAL – On failure to find the interface or get bad parameters.
- EPERM – Socket operation failed; for more details, check errno.h.

**Dependencies**

The interface used for IP communication must be pre-initialized with `v2x_radio_init()`. The handle from that function must be used as the parameter in this function.

#### 4.23.4.33 `v2x_status_enum_type v2x_set_peak_tx_power ( int8_t txPower )`

Set RF peak cv2x transmit power. This affects the power for all existing flows and for any flow created in the future.

On platforms with access control enabled, the caller needs to have TELUX\_CV2X\_CONFIG permission to successfully invoke this API.

Precondition – v2x mode enabled.

##### Parameters

in	<i>txPower</i>	Desired global Cv2x peak tx power in dbm
----	----------------	--

##### Returns

V2X\_STATUS\_SUCCESS on success. Error status otherwise.

#### 4.23.4.34 `v2x_status_enum_type v2x_set_l2_filters ( uint32_t list_len, src_l2_filter_info * list_array )`

Set src L2 ID list for filtering. This affects/disables receiving packets from the src L2 IDs in the list.

On platforms with access control enabled, the caller needs to have TELUX\_CV2X\_CONFIG permission to successfully invoke this API.

##### Parameters

in	<i>list_len</i>	number of rc L2 IDs, max value 50
in	<i>list_array</i>	array that stores the src L2 IDs, durations and pppp values for filter

##### Returns

V2X\_STATUS\_SUCCESS on success. Error status otherwise.

#### 4.23.4.35 `v2x_status_enum_type v2x_remove_l2_filters ( uint32_t list_len, uint32_t * l2_id_list )`

Remove specific src L2 ID list for filtering. This affects/enables receiving packets from the src L2 IDs in the list.

On platforms with access control enabled, the caller needs to have TELUX\_CV2X\_CONFIG permission to successfully invoke this API.

##### Parameters

in	<i>list_len</i>	number of rc L2 IDs, max value 50
in	<i>l2_id_list</i>	array that stores the src L2 IDs

**Returns**

V2X\_STATUS\_SUCCESS on success. Error status otherwise.

#### 4.23.4.36 **v2x\_status\_enum\_type v2x\_register\_tx\_status\_report\_listener ( uint16\_t port, v2x\_tx\_status\_report\_listener callback )**

Registers a listener for CV2X Tx status report.

**Associated data types**

v2x\_tx\_status\_report\_listener

**Parameters**

in	<i>port</i>	Set this value to the port number of registered Tx Flow if user wants to receive Tx status report associated with its own Tx flow. If user wants to receive Tx status report associated with all Tx flows in system, set this value to 0.
in	<i>callback</i>	Callback function of <a href="#">v2x_tx_status_report_listener</a> structure that is called on Tx status reports.

**Returns**

[V2X\\_STATUS\\_SUCCESS](#).

[V2X\\_STATUS\\_FAIL](#) – If there is an error.

**Dependencies**

CV2X radio must be pre-initialized with [v2x\\_radio\\_init\\_v2\(\)](#) or [v2x\\_radio\\_init\\_v3\(\)](#).

#### 4.23.4.37 **v2x\_status\_enum\_type v2x\_deregister\_tx\_status\_report\_listener ( uint16\_t port )**

Deregisters a listener for CV2X Tx status report.

**Associated data types**

v2x\_tx\_status\_report\_listener

**Parameters**

in	<i>port</i>	Port number of previously registered <a href="#">v2x_tx_status_report_listener</a> that is to be deregistered. If the listener is registered with port number 0, set this value to 0 to deregister the listener.
----	-------------	--

**Detailed description**

User will not receive Tx status reports after the deregistration.

**Returns**

[V2X\\_STATUS\\_SUCCESS](#).

[V2X\\_STATUS\\_FAIL](#) – If there is an error.

**Dependencies**

CV2X radio must be pre-initialized with [v2x\\_radio\\_init\\_v2\(\)](#) or [v2x\\_radio\\_init\\_v3\(\)](#).

#### 4.23.4.38 **v2x\_status\_enum\_type v2x\_set\_global\_IPaddr ( uint8\_t *prefix\_len*, uint8\_t \* *ipv6\_addr* )**

Set CV2X global IP address for the IP interface.

On platforms with access control enabled, the caller needs to have TELUX\_CV2X\_CONFIG permission to successfully invoke this API.

##### Parameters

in	<i>prefix_len</i>	CV2X global IP address prefix length in bits, range [64, 128]
in	<i>ipv6_addr</i>	CV2X global IP address.

##### Returns

V2X\_STATUS\_SUCCESS on success. Error status otherwise.

#### 4.23.4.39 **v2x\_status\_enum\_type v2x\_set\_ip\_routing\_info ( uint8\_t \* *dest\_mac\_addr* )**

Set CV2X IP interface global IP unicast routing information.

##### Parameters

in	<i>dest_mac_addr</i>	CV2X destination L2 address for unicast routing purpose. expecting a 6 bytes array address, in which the L2 addr stored in the last 3 entries in big endian order.
----	----------------------	--

##### Returns

V2X\_STATUS\_SUCCESS on success. Error status otherwise.

#### 4.23.4.40 **v2x\_status\_enum\_type v2x\_get\_ext\_radio\_status ( v2x\_radio\_status\_ex\_t \* *status* )**

Get current V2X overall radio status and per pool status.

##### Parameters

out	<i>status</i>	Pointer to structure <a href="#">v2x_radio_status_ex_t</a> , which contains V2X overall radio status and per pool status on success.
-----	---------------	--

##### Returns

V2X\_STATUS\_SUCCESS on success. Error status otherwise.

#### 4.23.4.41 **v2x\_status\_enum\_type v2x\_register\_ext\_radio\_status\_listener ( v2x\_ext\_radio\_status\_listener callback )**

Registers a listener for CV2X overall Tx/Rx status and per pool status.

##### Associated data types

v2x\_ext\_radio\_status\_listener

##### Parameters

in	<i>callback</i>	Callback function of <a href="#">v2x_ext_radio_status_listener</a> structure that is called on CV2X Tx/Rx status change.
----	-----------------	--

##### Returns

[V2X\\_STATUS\\_SUCCESS](#).

[V2X\\_STATUS\\_FAIL](#) – If there is an error.

#### 4.23.4.42 **v2x\_status\_enum\_type v2x\_get\_slss\_rx\_info ( v2x\_slss\_rx\_info\_t \* slss\_info )**

Get the current V2X SLSS Rx information.

##### Parameters

out	<i>slss_info</i>	Pointer to structure <a href="#">v2x_slss_rx_info_t</a> , which contains V2X SLSS Rx information on success.
-----	------------------	--

##### Returns

V2X\_STATUS\_SUCCESS on success. Error status otherwise.

#### 4.23.4.43 **v2x\_status\_enum\_type v2x\_register\_slss\_rx\_listener ( v2x\_slss\_rx\_listener callback )**

Registers a listener for CV2X SLSS Rx information.

##### Associated data types

v2x\_slss\_rx\_info\_listener

##### Parameters

in	<i>callback</i>	Callback function of <a href="#">v2x_slss_rx_listener</a> structure that is called on SLSS Rx information change.
----	-----------------	---

**Returns**

[V2X\\_STATUS\\_SUCCESS](#).

[V2X\\_STATUS\\_FAIL](#) – If there is an error.

#### 4.23.4.44 **v2x\_status\_enum\_type v2x\_deregister\_slss\_rx\_listener ( v2x\_slss\_rx\_listener callback )**

Deregisters a listener for CV2X SLSS Rx information.

**Associated data types**

[v2x\\_slss\\_rx\\_info\\_listener](#)

**Parameters**

in	<i>callback</i>	Previously registered <a href="#">v2x_slss_rx_listener</a> that is to be deregistered.
----	-----------------	--

**Returns**

[V2X\\_STATUS\\_SUCCESS](#).

[V2X\\_STATUS\\_FAIL](#) – If there is an error.

#### 4.23.4.45 **v2x\_status\_enum\_type v2x\_inject\_coarse\_utc\_time ( uint64\_t utc )**

Inject coarse UTC time when UE is synchronized to SLSS.

GNSS fix is not available when UE is synchronized to SLSS. To get accurate UTC time in this case, user can register a listener by invoking [v2x\\_register\\_utc\\_from\\_slss](#) and then inject coarse UTC time derived from received application messages using this API. The age of injected UTC time could be nearly 10 seconds at most. After that, accurate UTC time will be notified to user periodically through the registered listener.

On platforms with access control enabled, the caller needs to have `TELUX_CV2X_CONFIG` permission to successfully invoke this API.

**Parameters**

in	<i>utc</i>	UTC time since Jan. 1, 1970. Units: Milliseconds.
----	------------	---

**Returns**

[V2X\\_STATUS\\_SUCCESS](#) on success. Error status otherwise.



## 4.24 C Vehicle APIs

This section contains C Vehicle APIs related to Cellular-V2X operation. These APIs are provided as reference APIs to work with QTI reference hardware. Customers would need to modify the implementation of these APIs based on the specific H/W and CAN controller being used.

Abstraction of the vehicle system parameters required for CAM/BSM ITS beacons.

### 4.24.1 Define Documentation

#### 4.24.1.1 **#define V2X\_VDATA\_HANDLE\_BAD (-1)**

Invalid handle returned when there is an error.

#### 4.24.1.2 **#define V2X\_J2735\_TRACTION\_CONTROL\_MAX (4)**

Guard check value on [v2x\\_transmission\\_state\\_enum\\_type](#) for [V2X\\_TRANSMISSION\\_MAX](#). This value is used in a 3-bit bitfield in J2735.

#### 4.24.1.3 **#define V2X\_TRACTION\_CTRL\_MAX (4)**

Guard check value on [v2x\\_TractionControlStatus\\_enum\\_type](#) for [V2X\\_TRACTION\\_CTRL\\_MAX](#). This value is used in a 2-bit bitfield in J2735.

#### 4.24.1.4 **#define J2735\_ABS\_MAX (4)**

Guard check value on [v2x\\_AntiLockBrakeStatus\\_enum\\_type](#).

This value cannot be part of the enumeration because the value eventually ends up in 2-bit bitfield over the air.

#### 4.24.1.5 **#define V2X\_STABILITY\_CONTROL\_MAX (4)**

Guard check value on [v2x\\_StabilityControlStatus\\_enum\\_type](#).

This value is eventually used over the air in a 2-bit bitfield. The enumeration value must never be larger than 4.

#### 4.24.1.6 **#define V2X\_AUX\_BRAKE\_MAX (4)**

Guard check value on [v2x\\_AuxBrakeStatus\\_enum\\_type](#). This value must never be set this high.

## 4.24.2 Data Structure Documentation

### 4.24.2.1 union v2x\_control\_status\_ut

Contains information related to ABS, TCS, stability control state, and other vehicle output controls that might occur and be ongoing. This structure mirrors the J2735 bit frames.

#### Data fields

Type	Field	Description
struct <a href="#">v2x_control_status_ut</a>	bits	Bit values for control status information. Bit values for control status information.
unsigned short	word	Byte data access to the packed <a href="#">v2x_control_status</a> union structure.

### 4.24.2.2 struct v2x\_control\_status\_ut.bits

Bit values for control status information.

#### Data fields

Type	Field	Description
unsigned	unused_padding: 1	Reserved for 16-bit alignment. This field is critical because of 16-bit word access to the packed <a href="#">v2x_control_status_ut</a> union structure.
<a href="#">v2x_AuxBrakeStatus_enum_type</a>	aux_brake_status: 2	Indicates whether the auxiliary braking system is on. <b>Supported values:</b> <ul style="list-style-type: none"> <li>• 0 – Off</li> <li>• 1 – On</li> </ul>
<a href="#">v2x_BrakeBoostApplied_enum_type</a>	brake_boost_applied: 2	Indicates whether the brakes are actively being boosted. <b>Supported values:</b> <ul style="list-style-type: none"> <li>• 0 – Not boosted</li> <li>• 1 – Boosted</li> </ul>
<a href="#">v2x_StabilityControlStatus_enum_type</a>	stability_control_status: 2	Indicates whether stability control is on and engaged. <b>Supported values:</b> <ul style="list-style-type: none"> <li>• 0 – Off</li> <li>• 1 – On</li> </ul>
<a href="#">v2x_AntiLockBrakeStatus_enum_type</a>	antilock_brake_status: 2	Indicates the status of the ABS.
<a href="#">v2x_TractionControlStatus_enum_type</a>	traction_control_status: 2	Indicates whether status of the TCS.

Type	Field	Description
unsigned	rightRear: 1	Indicates whether the right rear brakes are actively being applied. <b>Supported values:</b> <ul style="list-style-type: none"> <li>• 0 – Not applied</li> <li>• 1 – Applied</li> </ul>
unsigned	rightFront: 1	Indicates whether the right front brakes are actively being applied. <b>Supported values:</b> <ul style="list-style-type: none"> <li>• 0 – Not applied</li> <li>• 1 – Applied</li> </ul>
unsigned	leftRear: 1	Indicates whether the left rear brakes are actively being applied <b>Supported values:</b> <ul style="list-style-type: none"> <li>• 0 – Not applied</li> <li>• 1 – Applied</li> </ul>
unsigned	leftFront: 1	Indicates whether the front left brakes are actively being applied. <b>Supported values:</b> <ul style="list-style-type: none"> <li>• 0 – Not applied</li> <li>• 1 – Applied</li> </ul>
unsigned	unavailable: 1	No information is available.

#### 4.24.2.3 union vehicleEventFlags\_ut

Contains critical events and communication of ongoing events. Also is used for combinations of critical and not critical (wipers) events

This typedef can match the J2735 2016 version or another version you are working with.

##### Data fields

Type	Field	Description
struct <a href="#">vehicle↔ EventFlags_ut</a>	bits	Bit values for vehicle event flags. A flag indicates the state of the event.Bit values for vehicle event flags.
unsigned short	data	Sixteen-bit word access to the packed vehicleEventFlags union structure.

#### 4.24.2.4 struct vehicleEventFlags\_ut.bits

Bit values for vehicle event flags. A flag indicates the state of the event.

##### Data fields

Type	Field	Description
unsigned	unused: 3	Reserved for 16-bit alignment in the union access.
unsigned	eventAirBag↔ Deployment: 1	Indicates whether the airbag is deployed. <b>Supported values:</b> <ul style="list-style-type: none"> <li>• 0 – Not deployed</li> <li>• 1 – Deployed</li> </ul>
unsigned	event↔ Disabled↔ Vehicle: 1	Indicates whether the vehicle is disabled. <b>Supported values:</b> <ul style="list-style-type: none"> <li>• 0 – Not disabled</li> <li>• 1 – Disabled</li> </ul>
unsigned	eventFlatTire: 1	Indicates whether the tire is flat. <b>Supported values:</b> <ul style="list-style-type: none"> <li>• 0 – Not flat</li> <li>• 1 – Flat</li> </ul>
unsigned	eventWipers↔ Changed: 1	Indicates the status of the windshield wipers. For more information, See the wiper state variables in <a href="#">current_dynamic_vehicle_state_t</a> .
unsigned	eventLights↔ Changed: 1	Indicates the status of one or more lights (such as blinkers and fog).
unsigned	eventHard↔ Braking: 1	Indicates whether hard braking is activated. <b>Supported values:</b> <ul style="list-style-type: none"> <li>• 0 – Not activated</li> <li>• 1 – Activated</li> </ul>
unsigned	event↔ Reserved1: 1	Event bit reserved for future use. Do not use.
unsigned	event↔ Hazardous↔ Materials: 1	Indicates whether a hazmat load is present. <b>Supported values:</b> <ul style="list-style-type: none"> <li>• 0 – Not present</li> <li>• 1 – Present</li> </ul>
unsigned	eventStability↔ Controlactivated↔ : 1	Indicates whether stability control is on. <b>Supported values:</b> <ul style="list-style-type: none"> <li>• 0 – Off</li> <li>• 1 – On</li> </ul>
unsigned	eventTraction↔ ControlLoss: 1	Indicates whether traction control is activated (1) or not (0). <b>Supported values:</b> <ul style="list-style-type: none"> <li>• 0 – Not applied</li> <li>• 1 – Applied</li> </ul>

Type	Field	Description
unsigned	eventAB↔ Sactivated: 1	Indicates whether ABS is activated.  <b>Supported values:</b> <ul style="list-style-type: none"> <li>• 0 – Not activated</li> <li>• 1 – Activated</li> </ul>
unsigned	eventStop↔ LineViolation: 1	Indicates whether the vehicle has detected that a violation of the Stop Line is imminent.  <b>Supported values:</b> <ul style="list-style-type: none"> <li>• 0 – Not imminent</li> <li>• 1 – Imminent</li> </ul>
unsigned	eventHazard↔ Lights: 1	Indicates whether the hazard lights are on.  <b>Supported values:</b> <ul style="list-style-type: none"> <li>• 0 – Off</li> <li>• 1 – On</li> </ul>

#### 4.24.2.5 union ExteriorLights\_ut

Contains information about the state of the exterior lights.

##### Data fields

Type	Field	Description
struct <a href="#">Exterior↔ Lights_ut</a>	bits	Bit values for exterior light flags.Bit values for exterior light flags.
unsigned short	data	16-bit short word access to the packed ExteriorLights union structure.

#### 4.24.2.6 struct ExteriorLights\_ut.bits

Bit values for exterior light flags.

##### Data fields

Type	Field	Description
unsigned	parking↔ LightsOn: 1	Indicates whether the parking lights are on.  <b>Supported values:</b> <ul style="list-style-type: none"> <li>• 0 – Off</li> <li>• 1 – On</li> </ul>
unsigned	fogLightOn: 1	Indicates whether the fog lights are on.  <b>Supported values:</b> <ul style="list-style-type: none"> <li>• 0 – Off</li> <li>• 1 – On</li> </ul>

Type	Field	Description
unsigned	daytime↔ Running↔ LightsOn: 1	Indicates whether the running lights are on. <b>Supported values:</b> • 0 – Off • 1 – On
unsigned	automatic↔ LightControl↔ On: 1	Indicates whether the automatic light control is on. <b>Supported values:</b> • 0 – Off • 1 – On
unsigned	hazardSignal↔ On: 1	Indicates whether the hazard lights are on. <b>Supported values:</b> • 0 – Off • 1 – On
unsigned	rightTurn↔ SignalOn: 1	Indicates whether the right turn light is on. <b>Supported values:</b> • 0 – Off • 1 – On
unsigned	leftTurn↔ SignalOn: 1	Indicates whether the left turn light is on. <b>Supported values:</b> • 0 – Off • 1 – On
unsigned	highBeam↔ HeadlightsOn: 1	Indicates whether the high beam headlights are on. <b>Supported values:</b> • 0 – Off • 1 – On
unsigned	lowBeam↔ HeadlightsOn: 1	Indicates whether the low beam headlights are on. <b>Supported values:</b> • 0 – Off • 1 – On
unsigned	unused: 7	Unused padding bits.

#### 4.24.2.7 struct high\_resolution\_motion\_t

Contains high-resolution motion parameters.

##### Data fields

Type	Field	Description
double	vehicle_speed	Vehicle speed in meters/second.
double	longitudinal_↔ acceleration	Acceleration in a longitudinal direction, in meters/second <sup>2</sup> .
double	yaw_rate	Yaw rate in degrees/second, per SAE J2735.

#### 4.24.2.8 struct current\_dynamic\_vehicle\_state\_t

Contains information about the dynamic state of the vehicle.

##### Data fields

Type	Field	Description
<a href="#">v2x_↔ transmission_↔ state_enum_↔ type</a>	prndl	Specifies the current state of the transmission gear: forward, reverse, and so on.
<a href="#">vehicleEvent↔ Flags_ut</a>	events	Flags all critical events and combinations of critical events.
double	throttle_↔ position	Per the J2735 definition, indicates the throttle position from 0% to 100%. However, this value is in double precision between 0 and 1.
double	throttle_↔ confidence	Per the J2735 definition, double precision degrees of confidence.
double	steering_↔ wheel_angle	Per the J2735 definition, double precision degrees of the wheel angle. <b>Supported values:</b> -192.0 through 189.0 degrees, with positive being turned to the right
<a href="#">v2x_control_↔ status_ut</a>	brake_status	Indicates whether brakes or emergency brakes (ABS) are activated. <b>Supported values:</b> <ul style="list-style-type: none"> <li>• 0 – Not activated</li> <li>• 1 – Activated</li> </ul>
<a href="#">Exterior↔ Lights_ut</a>	exterior_lights	Conglomeration of bits that indicate the status of the exterior lights, such as blinkers.
unsigned char	front_wiper_↔ status	Status of the front windshield wipers.
unsigned char	rear_wiper_↔ status	Status of the rear windshield wipers.

#### 4.24.2.9 struct static\_vehicle\_parameters\_t

Contains static vehicle parameters.

##### Data fields

Type	Field	Description
double	vehicle_↔ height_cm	Vehicle height in centimeters. This parameter is 0 if the value is not yet available from the vehicle network.
double	vehicle_↔ width_cm	Vehicle width in centimeters. This parameter is 0 if the value is not yet available from the vehicle network.
double	vehicle_↔ length_cm	Vehicle length in centimeters. This parameter is 0 if the value is not yet available from the vehicle network.

Type	Field	Description
double	front_bumper↔ _height_cm	Height of the front bumper, in centimeters. This parameter is 0 if the value is not yet available from the vehicle network.
double	rear_bumper↔ height_cm	Height of the rear bumper, in centimeters. This parameter is 0 if the value is not yet available from the vehicle network.
double	vehicle_mass↔ _kg	Mass of the vehicle, in kilograms. This parameter is 0 if the value is not yet available from the vehicle network.
double	trailer↔ weight_kg	Weight of a trailer connected to the vehicle, in kilograms. This parameter is 0 if the value is not yet available from the vehicle network.
char *	make	Pointer to the NULL-terminated string with the vehicle manufacturer that this software build supports (such as Ford and GM).
char *	model	Pointer to the NULL-terminated string with the vehicle model name that this software build supports (such as Prius, Mustang, Rogue).
unsigned short	begin_model↔ _year	Beginning of the model years that this software build supports.
unsigned short	end_model↔ _year	End of model year that this software build supports. This year might be the same as begin_model_year.



## 4.24.3 Enumeration Type Documentation

### 4.24.3.1 enum v2x\_transmission\_state\_enum\_type

Valid types for main transmission drive states.

#### Enumerator

**V2X\_TRANSMISSION\_NEUTRAL**  
**V2X\_TRANSMISSION\_PARK**  
**V2X\_TRANSMISSION\_FORWARD\_GEARs** One of the gears: D, 1, 2, 3, ... .  
**V2X\_TRANSMISSION\_REVERSE\_GEARs**  
**V2X\_TRANSMISSION\_RESERVED1**  
**V2X\_TRANSMISSION\_RESERVED2**  
**V2X\_TRANSMISSION\_RESERVED3**  
**V2X\_TRANSMISSION\_UNAVAILABLE** Status is unknown.  
**V2X\_TRANSMISSION\_MAX** Sentry variable that must not be exceeded.

### 4.24.3.2 enum v2x\_BrakeBoostApplied\_enum\_type

Valid types for brake boosting states.

#### Enumerator

**V2X\_BRAKEBOOST\_UNAVAIL** Status is unknown.  
**V2X\_BRAKEBOOST\_OFF**  
**V2X\_BRAKEBOOST\_ON**  
**V2X\_BRAKEBOOST\_MAX** Sentry variable that must not be exceeded.

### 4.24.3.3 enum v2x\_TractionControlStatus\_enum\_type

Valid types for traction control states.

This enumeration currently matches the J2735 2016 version for the Traction Control System (TCS).

#### Enumerator

**V2X\_TRACTION\_CTRL\_UNAVAIL** Status is unknown.  
**V2X\_TRACTION\_CTRL\_OFF**  
**V2X\_TRACTION\_CTRL\_ON** On but currently not engaged.  
**V2X\_TRACTION\_CTRL\_ENGAGED** Actively being engaged.

#### 4.24.3.4 enum v2x\_AntiLockBrakeStatus\_enum\_type

Valid types for antilock-braking states.

This enumeration matches the J2735 2016 version for the Antilock Braking System (ABS) to help BSM packing and unpacking.

##### Enumerator

**V2X\_ABS\_Unavailable** ABS is not equipped, or the status is unknown.

**V2X\_ABS\_Off**

**V2X\_ABS\_On** On but currently not active.

**V2X\_ABS\_Engaged** Actively being engaged on one or more wheels.

#### 4.24.3.5 enum v2x\_StabilityControlStatus\_enum\_type

Valid types for the stability control status. This enumeration should be equivalent to the J2735 BSM version you are working with.

##### Enumerator

**V2X\_STABILITY\_CONTROL\_UNAVAILBLE** Stability Control status is unknown.

**V2X\_STABILITY\_CONTROL\_OFF** Stability Control is not applied.

**V2X\_STABILITY\_CONTROL\_ON** Stability Control is on, but currently it is not engaged.

**V2X\_STABILITY\_CONTROL\_ENGAGED** Stability Control is actively being engaged.

#### 4.24.3.6 enum v2x\_AuxBrakeStatus\_enum\_type

Valid types for the auxiliary brake status.

This enumeration should match the J2735 2016 version or any other version you are working with.

##### Enumerator

**V2X\_AUX\_BRAKE\_UNAVAILBLE** Vehicle has no auxiliary brake equipment or the status is unknown.

**V2X\_AUX\_BRAKE\_OFF**

**V2X\_AUX\_BRAKE\_ON**

**V2X\_AUX\_BRAKE\_RESERVED**

## 4.24.4 Function Documentation

### 4.24.4.1 `v2x_api_ver_t v2x_vehicle_api_version ( void )`

Gets the compiled API version interface (as an integer number).

#### Returns

`v2x_api_ver_t` – Filled with the version number, build date, and detailed build information.

### 4.24.4.2 `v2x_status_enum_type v2x_vehicle_get_static_params ( static_vehicle_↔ parameters_t * parameters )`

Returns (via a reference pointer) the `static_vehicle_parameters_t` structure that enumerates static (unchanging) data items used by ITS stacks.

#### Associated data types

`static_vehicle_parameters_t`

#### Parameters

out	<i>parameters</i>	Pointer to the static vehicle parameters, including vehicle dimensions, make, model, and so on.
-----	-------------------	---

#### Detailed description

This call is a nonblocking call. If the values are not yet available from the vehicle, the data element is 0 (NULL).

Because this function is sometimes populated with data from an in-vehicle network, it might be incomplete and only partially populated early in a system start-up. However, all values can be statically compiled in or loaded from an initialization file. In this case, the data is fully provided on the first call.

#### Returns

`V2X_STATUS_SUCCESS` – This function is successfully populated with the results.

Error code – If there is a problem (see `v2x_status_enum_type`).

#### 4.24.4.3 `v2x_motion_data_handle_t v2x_high_res_motion_register_listener ( v2x_high_res_motion_listener_t cb )`

Registers for high-resolution motion callbacks from the vehicle data network (CAN bus) when the data changes.

##### Associated data types

[v2x\\_high\\_res\\_motion\\_listener\\_t](#)

##### Parameters

<code>in</code>	<code>cb</code>	Callback function to use for this listener.
-----------------	-----------------	---

##### Returns

Handle number to use with subsequent deregister calls.

-1 – If there is an error in registering a callback.

#### 4.24.4.4 `v2x_status_enum_type v2x_high_res_motion_deregister_listener ( v2x_motion_data_handle_t handle )`

Deregisters a previously registered high-resolution motion data callback that was requested via [v2x\\_high\\_res\\_motion\\_register\\_listener\(\)](#).

##### Associated data types

[v2x\\_motion\\_data\\_handle\\_t](#)

##### Parameters

<code>in</code>	<code>handle</code>	Handle of the listener callback previously set up.
-----------------	---------------------	--

##### Returns

[V2X\\_STATUS\\_SUCCESS](#).

##### Dependencies

The callback must have been previously registered with [v2x\\_high\\_res\\_motion\\_register\\_listener\(\)](#).

#### 4.24.4.5 `v2x_vehicle_handle_t v2x_vehicle_register_listener ( v2x_vehicle_event_listener_t cb, void * context )`

Registers for a callback for state updates from the vehicle data network (CAN bus). This function requests vehicle data callbacks when data changes or events occur.

##### Associated data types

[v2x\\_vehicle\\_event\\_listener\\_t](#)

##### Parameters

in	<i>cb</i>	Callback function to use for this listener.
in	<i>context</i>	Pointer to the application context for use with the callbacks, which can help the caller code.

##### Returns

Handle number to use with subsequent deregister calls.

-1 – If there is an error in registering a callback.

#### 4.24.4.6 `v2x_status_enum_type v2x_vehicle_deregister_for_callback ( v2x_vehicle_handle_t handle )`

Deregisters a previously registered dynamic event callback that was requested via [v2x\\_vehicle\\_register\\_listener\(\)](#).

##### Associated data types

[v2x\\_vehicle\\_handle\\_t](#)

##### Parameters

in	<i>handle</i>	Handle of the listener callback previously set up.
----	---------------	--

##### Returns

[V2X\\_STATUS\\_SUCCESS](#) – If the callback is successfully deregistered.

##### Dependencies

The callback must have been previously registered.

## 4.25 C Config APIs

This section contains C Config APIs related to Cellular-V2X operation. These APIs are provided as an abstraction of the CV2X configuration relevant interfaces.

Abstraction of the CV2X configuration relevant interfaces.

### 4.25.1 Data Structure Documentation

#### 4.25.1.1 struct v2x\_config\_event\_info\_t

Information about any update to a V2X config file.

##### Data fields

Type	Field	Description
<a href="#">v2x_config_source_t</a>	source	The type of the V2X config file.
<a href="#">v2x_config_event_t</a>	event	Config file event.

## 4.25.2 Enumeration Type Documentation

### 4.25.2.1 enum v2x\_config\_soure\_t

V2X configuration source types listed in ascending order of priority. The system always uses the V2X configuration with the highest priority if multiple V2X configuration sources exist.

#### Enumerator

**V2X\_CONFIG\_SOURCE\_UNKNOWN** V2X config file source is unknown  
**V2X\_CONFIG\_SOURCE\_PRECONFIG** V2X config file source is preconfig  
**V2X\_CONFIG\_SOURCE\_SIM\_CARD** V2X config file source is SIM card  
**V2X\_CONFIG\_SOURCE\_OMA\_DM** V2X config file source is OMA-DM

### 4.25.2.2 enum v2x\_config\_event\_t

Events relevant to CV2X config file.

#### Enumerator

**V2X\_CONFIG\_EVENT\_CHANGED** V2X config file is changed  
**V2X\_CONFIG\_EVENT\_EXPIRED** V2X config file is expired

## 4.25.3 Function Documentation

### 4.25.3.1 v2x\_status\_enum\_type v2x\_register\_for\_config\_change\_ind ( cv2x\_config↔ \_event\_listener callback )

Register listener for any updates to CV2X configuration.

#### Associated data types

cv2x\_config\_event\_listener

#### Parameters

in	<i>callback</i>	Callback function of <a href="#">cv2x_config_event_listener</a> structure that is used during CV2X config events (such as CV2X configuration expriy or changed).
----	-----------------	--

#### Detailed description

This function should be called before calling [v2x\\_update\\_configuration](#) or [v2x\\_retrieve\\_configuration](#) if the caller has interest in the notification of V2X configuration events.

**V2X\_CONFIG\_EVENT\_CHANGED** [v2x\\_config\\_event\\_t](#) is sent to registered CV2X configuration listeners if the content of the active V2X configuration file is changed by calling [v2x\\_update\\_configuration](#) or the active V2X configuration file source [v2x\\_config\\_soure\\_t](#) is changed from one type to another.

V2X\_CONFIG\_EVENT\_EXPIRED [v2x\\_config\\_event\\_t](#) is sent to registered CV2X configuration listeners when the active V2X configuration file is expired.

**Returns**

[V2X\\_STATUS\\_SUCCESS](#).

[V2X\\_STATUS\\_FAIL](#) – If there is an error.



### 4.25.3.2 `v2x_status_enum_type v2x_update_configuration ( const char * config_file_path )`

Updates the OMA-DM V2X radio configuration file.

On platforms with access control enabled, the caller needs to have `TELUX_CV2X_CONFIG` permission to successfully invoke this API.

#### Parameters

in	<i>config_file_path</i>	Pointer to the path of the configuration file.
----	-------------------------	--

#### Detailed description

The V2X radio status must be `INACTIVE`. If the V2X status is `ACTIVE` or `SUSPENDED` (see [v2x\\_event\\_t](#)), call `stop_v2x_mode()` first.

The functionality of V2X configuration expiration is supported by adding an expiration leaf to the V2X configuration file passed in. When the active configuration expires, the system fallbacks to a lower priority V2X configuration `v2x_config_soure_t` if existed. If the V2X status is active, it changes to suspended when the active V2X configuration expires and then changes to active after the system fallbacks to a lower priority V2X configuration or changes to inactive if no V2X configuration is available.

This call is a blocking call. When it returns the configuration has been updated, assuming no error.

#### Returns

[V2X\\_STATUS\\_SUCCESS](#).

Otherwise:

- [V2X\\_STATUS\\_EALREADY](#) – Failure because V2X status is not [V2X\\_INACTIVE](#).
- [V2X\\_STATUS\\_FAIL](#) – Other failure.

#### Dependencies

V2X radio status must be [V2X\\_INACTIVE](#) ([v2x\\_event\\_t](#)).

### 4.25.3.3 `v2x_status_enum_type v2x_retrieve_configuration ( const char * config_file_path )`

Retrieve the V2X radio configuration file.

On platforms with access control enabled, the caller needs to have `TELUX_CV2X_CONFIG` permission to successfully invoke this API.

#### Parameters

in	<code>config_file_path</code>	Pointer to the path of the configuration file.
----	-------------------------------	--

This call is a blocking call. When it returns the configuration has been read out, assuming no error.

#### Returns

[V2X\\_STATUS\\_SUCCESS](#).

Otherwise:

- [V2X\\_STATUS\\_FAIL](#) – Other failure.

## 4.26 C Packet APIs

This section contains C Packet APIs related to Cellular-V2X packet analysis operation.

Provide utilities and structures for CV2X packet analysis.

### 4.26.1 Define Documentation

#### 4.26.1.1 #define META\_DATA\_MASK\_SFN 0x01

meta data validity mask of each received packet, used by [rx\\_packet\\_meta\\_data\\_t](#)

#### 4.26.1.2 #define META\_DATA\_MASK\_SUB\_CHANNEL\_INDEX 0x02

#### 4.26.1.3 #define META\_DATA\_MASK\_SUB\_CHANNEL\_NUM 0x04

#### 4.26.1.4 #define META\_DATA\_MASK\_PRX\_RSSI 0x08

#### 4.26.1.5 #define META\_DATA\_MASK\_DRX\_RSSI 0x10

#### 4.26.1.6 #define META\_DATA\_MASK\_L2\_DEST 0x20

#### 4.26.1.7 #define META\_DATA\_MASK\_SCI\_FORMAT1 0x40

#### 4.26.1.8 #define META\_DATA\_MASK\_DELAY\_ESTI 0x80

### 4.26.2 Data Structure Documentation

#### 4.26.2.1 struct rx\_packet\_meta\_data\_t

Contains the detailed meta data report of a packet received.

##### Data fields

Type	Field	Description
uint32_t	validity	Validity of the meta data
uint16_t	sfn	System Frame Number * 10 + subframe number
uint8_t	sub_channel_↔ index	The subchannel used for transmission
uint8_t	sub_channel_↔ num	Number of subchannels in the Rx pool
int8_t	prx_rssi	RSSI of primary receive signal, in dBm
int8_t	drx_rssi	RSSI of diversity receive signal, in dBm
uint32_t	l2_↔ destination_id	L2 destination ID
uint32_t	sci_format1_↔ info	SCI format1, 3GPP TS 36.213 section 14.1
int32_t	delay_↔ estimation	Packet delay estimation, in Ts (1/(15000 * 2048) seconds)

## 4.26.3 Function Documentation

### 4.26.3.1 `v2x_status_enum_type v2x_parse_rx_meta_data ( const uint8_t * payload, uint32_t length, rx_packet_meta_data_t * meta_data, size_t * num, size_t * meta_data_len )`

Parse the received packet's meta data from the payload

#### Associated data types

[rx\\_packet\\_meta\\_data\\_t](#)

#### Parameters

in	<i>payload</i>	Pointer to the received message which may contains the meta data reports
in	<i>length</i>	Length of the received message in byte
out	<i>meta_data</i>	Pointer to the meta data structure array
in, out	<i>num</i>	array size of meta_data as input, be assigned to the number of meta data reports parsed out. The caller can use this value to index the array meta_data.
out	<i>meta_data_len</i>	length of the meta data in byte parsed out from the payload

#### Detailed description

This function extracts the received packet's meta data from the payload, there maybe several meta data reports in the received payload.

#### Returns

[V2X\\_STATUS\\_SUCCESS](#).

Otherwise:

- [V2X\\_STATUS\\_FAIL](#) – Other failure.

## 4.27 CPP APIs

This section contains C++ APIs related to Cellular-V2X operation. Applications need to have "radio" Linux group permissions to be able to operate successfully with underlying services.

•

### 4.27.1 Data Structure Documentation

#### 4.27.1.1 class telux::cv2x::ICv2xConfigListener

Listeners for [ICv2xConfig](#) must implement this interface.

##### Public member functions

- virtual void [onConfigChanged](#) (const [ConfigEventInfo](#) &info)
- virtual [~ICv2xConfigListener](#) ()

##### 4.27.1.1.1 Constructors and Destructors

4.27.1.1.1 virtual [telux::cv2x::ICv2xConfigListener::~~ICv2xConfigListener](#) ( ) [[virtual](#)]

Destructor for [ICv2xConfigListener](#)

##### 4.27.1.1.2 Member Function Documentation

4.27.1.1.2.1 virtual void [telux::cv2x::ICv2xConfigListener::onConfigChanged](#) ( const [ConfigEventInfo](#) &  
*info* ) [[virtual](#)]

Called when CV2X configuration has changed in the below scenarios:

1. The specified configuration source has expired.
2. The active configuration source has changed to the specified configuration source type due to the expiration of the configuration source being used.
3. The specified configuration source has been updated.

##### Parameters

in	<i>info</i>	- Information of CV2X configuration event.
----	-------------	--

#### 4.27.1.2 class telux::cv2x::ICv2xConfig

Cv2xConfig provide operations to update or request [cv2x](#) configuration.

**Public member functions**

- virtual `~ICv2xConfig ()`
- virtual `bool isReady ()=0`
- virtual `std::future< bool > onReady ()=0`
- virtual `telux::common::ServiceStatus getServiceStatus ()=0`
- virtual `telux::common::Status updateConfiguration (const std::string &configFilePath, telux::common::ResponseCallback cb)=0`
- virtual `telux::common::Status retrieveConfiguration (const std::string &configFilePath, telux::common::ResponseCallback cb)=0`
- virtual `telux::common::Status registerListener (std::weak_ptr< ICv2xConfigListener > listener)=0`
- virtual `telux::common::Status deregisterListener (std::weak_ptr< ICv2xConfigListener > listener)=0`

**4.27.1.2.1 Constructors and Destructors**

**4.27.1.2.1.1** `virtual telux::cv2x::ICv2xConfig::~~ICv2xConfig ( ) [virtual]`

**4.27.1.2.2 Member Function Documentation**

**4.27.1.2.2.1** `virtual bool telux::cv2x::ICv2xConfig::isReady ( ) [pure virtual]`

Checks if the Cv2x Config Manager is ready.

**Returns**

True if Cv2x Config is ready for service, otherwise returns false.

**Deprecated**

use `getServiceStatus` instead

**4.27.1.2.2.2** `virtual std::future<bool> telux::cv2x::ICv2xConfig::onReady ( ) [pure virtual]`

Wait for Cv2x Config to be ready.

**Returns**

A future that caller can wait on to be notified when Cv2x Radio Manager is ready.

**Deprecated**

the readiness can be notified via the callback passed to `Cv2xFactory::getCv2xConfig`.

#### 4.27.1.2.2.3 virtual telux::common::ServiceStatus telux::cv2x::ICv2xConfig::getServiceStatus ( ) [pure virtual]

This status indicates whether the Cv2xConfig is in a usable state.

#### Returns

SERVICE\_AVAILABLE - If cv2x config is ready for service. SERVICE\_UNAVAILABLE - If cv2x config is temporarily unavailable. SERVICE\_FAILED - If cv2x config encountered an irrecoverable failure.

#### 4.27.1.2.2.4 virtual telux::common::Status telux::cv2x::ICv2xConfig::updateConfiguration ( const std::string & configFilePath, telux::common::ResponseCallback cb ) [pure virtual]

Updates CV2X configuration. Requires CV2X TX/RX radio status be Inactive. If CV2X radio status is Active or Suspended, call [ICv2xRadioManager::stopCv2x](#) before trying to update configuration. The functionality of V2X configuration expiration is supported by adding an expiration leaf to the V2X configuration file passed in. When the active configuration expires, the system fallbacks to a lower priority V2X configuration [ConfigSourceType](#) if existed. If the V2X status is active, it changes to suspended when the active V2X configuration expires and then changes to active after the system fallbacks to a lower priority V2X configuration or changes to inactive if no V2X configuration is available.

On platforms with access control enabled, the caller needs to have TELUX\_CV2X\_CONFIG permission to successfully invoke this API.

#### Parameters

in	<i>configFilePath</i>	- Path to config file. This is the fully qualified file path including the name of the file.
in	<i>cb</i>	- Callback that is invoked when the send is complete. This may be null.

#### 4.27.1.2.2.5 virtual telux::common::Status telux::cv2x::ICv2xConfig::retrieveConfiguration ( const std::string & configFilePath, telux::common::ResponseCallback cb ) [pure virtual]

Retrieve active CV2X configuration. The calling application should have write access to the path specified by configFilePath. And if the v2x configuration retrieval request succeed, the file specified by configFilePath will be created and filled with the configuration contents. Otherwise, no file will be created.

On platforms with access control enabled, the caller needs to have TELUX\_CV2X\_CONFIG permission to successfully invoke this API.

#### Parameters

in	<i>configFilePath</i>	- Path to config file. This is the fully qualified file path including the name of the file.
in	<i>cb</i>	- Callback that is invoked when the configuration retrieval is complete. This may be null.

**4.27.1.2.2.6** `virtual telux::common::Status telux::cv2x::ICv2xConfig::registerListener ( std::weak_ptr< ICv2xConfigListener > listener ) [pure virtual]`

Registers a listener for this [ICv2xConfig](#).

#### Parameters

in	<i>listener</i>	- Listener that implements <a href="#">ICv2xConfigListener</a> interface.
----	-----------------	---

**4.27.1.2.2.7** `virtual telux::common::Status telux::cv2x::ICv2xConfig::deregisterListener ( std::weak_ptr< ICv2xConfigListener > listener ) [pure virtual]`

Deregisters a listener for this [ICv2xConfig](#).

#### Parameters

in	<i>listener</i>	- Previously registered <a href="#">ICv2xConfigListener</a> that is to be deregistered.
----	-----------------	---

### 4.27.1.3 class telux::cv2x::Cv2xFactory

[Cv2xFactory](#) is the factory that creates the Cv2x Radio.

#### Public member functions

- virtual `std::shared_ptr< ICv2xRadioManager > getCv2xRadioManager (telux::common::InitResponseCb cb=nullptr)`
- virtual `std::shared_ptr< ICv2xConfig > getCv2xConfig (telux::common::InitResponseCb cb=nullptr)`
- virtual `std::shared_ptr< ICv2xThrottleManager > getCv2xThrottleManager (telux::common::InitResponseCb cb=nullptr)`

#### Static Public Member Functions

- static `Cv2xFactory & getInstance ()`

#### 4.27.1.3.1 Member Function Documentation

**4.27.1.3.1.1** `static Cv2xFactory& telux::cv2x::Cv2xFactory::getInstance ( ) [static]`

Get [Cv2xFactory](#) instance

#### Returns

Reference to [Cv2xFactory](#) singleton.



**4.27.1.3.1.2** virtual std::shared\_ptr<ICv2xRadioManager> telux::cv2x::Cv2xFactory::getCv2xRadioManager ( telux::common::InitResponseCb cb = nullptr ) [virtual]

Get Cv2xRadioManager instance.

#### Parameters

in	cb	- Optional callback to get Cv2xRadioManager initialization status
----	----	---

#### Returns

shared pointer to Cv2x Radio Manager upon success. nullptr otherwise.

**4.27.1.3.1.3** virtual std::shared\_ptr<ICv2xConfig> telux::cv2x::Cv2xFactory::getCv2xConfig ( telux::common::InitResponseCb cb = nullptr ) [virtual]

Get Cv2xConfig instance.

#### Parameters

in	cb	- Optional callback to get Cv2xConfig initialization status
----	----	---

#### Returns

shared pointer to Cv2x Config upon success. nullptr otherwise.

**4.27.1.3.1.4** virtual std::shared\_ptr<ICv2xThrottleManager> telux::cv2x::Cv2xFactory::getCv2xThrottleManager ( telux::common::InitResponseCb cb = nullptr ) [virtual]

Get Cv2xThrottleManager instance.

#### Returns

shared pointer to Cv2x ThrottleManager upon success. nullptr otherwise.

### 4.27.1.4 class telux::cv2x::ICv2xRadio

This is class encapsulates a Cv2xRadio interface.

Returned from [ICv2xRadioManager::getCv2xRadio](#)

#### Public member functions

- virtual bool [isInitialized](#) () const =0
- virtual [telux::common::Status registerListener](#) (std::weak\_ptr< [ICv2xRadioListener](#) > listener)=0
- virtual [telux::common::Status deregisterListener](#) (std::weak\_ptr< [ICv2xRadioListener](#) > listener)=0
- virtual [telux::common::Status createRxSubscription](#) ([TrafficIpType](#) ipType, uint16\_t port,

- `CreateRxSubscriptionCallback` cb, `std::shared_ptr< std::vector< uint32_t >> idList=nullptr`)=0
- virtual `telux::common::ServiceStatus` `getServiceStatus` ()=0
  - virtual `telux::common::Status` `enableRxMetaDataReport` (`TrafficIpType` ipType, bool enable, `std::shared_ptr< std::vector< std::uint32_t >> idList`, `telux::common::ResponseCallback` cb)=0
  - virtual `telux::common::Status` `createTxSpsFlow` (`TrafficIpType` ipType, `uint32_t` serviceId, const `SpsFlowInfo` &spsInfo, `uint16_t` spsSrcPort, bool eventSrcPortValid, `uint16_t` eventSrcPort, `CreateTxSpsFlowCallback` cb)=0
  - virtual `telux::common::Status` `createTxEventFlow` (`TrafficIpType` ipType, `uint32_t` serviceId, `uint16_t` eventSrcPort, `CreateTxEventFlowCallback` cb)=0
  - virtual `telux::common::Status` `createTxEventFlow` (`TrafficIpType` ipType, `uint32_t` serviceId, const `EventFlowInfo` &flowInfo, `uint16_t` eventSrcPort, `CreateTxEventFlowCallback` cb)=0
  - virtual `telux::common::Status` `closeRxSubscription` (`std::shared_ptr< ICv2xRxSubscription >` rxSub, `CloseRxSubscriptionCallback` cb)=0
  - virtual `telux::common::Status` `closeTxFlow` (`std::shared_ptr< ICv2xTxFlow >` txFlow, `CloseTxFlowCallback` cb)=0
  - virtual `telux::common::Status` `changeSpsFlowInfo` (`std::shared_ptr< ICv2xTxFlow >` txFlow, const `SpsFlowInfo` &spsInfo, `ChangeSpsFlowInfoCallback` cb)=0
  - virtual `telux::common::Status` `requestSpsFlowInfo` (`std::shared_ptr< ICv2xTxFlow >` txFlow, `RequestSpsFlowInfoCallback` cb)=0
  - virtual `telux::common::Status` `changeEventFlowInfo` (`std::shared_ptr< ICv2xTxFlow >` txFlow, const `EventFlowInfo` &flowInfo, `ChangeEventFlowInfoCallback` cb)=0
  - virtual `telux::common::Status` `requestCapabilities` (`RequestCapabilitiesCallback` cb)=0
  - virtual `telux::common::Status` `requestDataSessionSettings` (`RequestDataSessionSettingsCallback` cb)=0
  - virtual `telux::common::Status` `updateSrcL2Info` (`UpdateSrcL2InfoCallback` cb)=0
  - virtual `telux::common::Status` `updateTrustedUEList` (const `TrustedUEInfoList` &infoList, `UpdateTrustedUEListCallback` cb)=0
  - virtual `~ICv2xRadio` ()
  - virtual `std::string` `getIfaceNameFromIpType` (`TrafficIpType` ipType)=0
  - virtual `telux::common::Status` `createCv2xTcpSocket` (const `EventFlowInfo` &eventInfo, const `SocketInfo` &sockInfo, `CreateTcpSocketCallback` cb)=0
  - virtual `telux::common::Status` `closeCv2xTcpSocket` (`std::shared_ptr< ICv2xTxRxSocket >` sock, `CloseTcpSocketCallback` cb)=0
  - virtual `telux::common::Status` `registerTxStatusReportListener` (`uint16_t` port, `std::shared_ptr< ICv2xTxStatusReportListener >` listener, `telux::common::ResponseCallback` cb)=0
  - virtual `telux::common::Status` `deregisterTxStatusReportListener` (`uint16_t` port, `telux::common::ResponseCallback` cb)=0
  - virtual `telux::common::Status` `setGlobalIPInfo` (const `IPv6AddrType` &ipv6Addr, `common::ResponseCallback` cb)=0

- virtual `telux::common::Status setGlobalIPUnicastRoutingInfo (const GlobalIPUnicastRoutingInfo &destL2Addr, common::ResponseCallback cb)=0`
- virtual `Cv2xRadioCapabilities getCapabilities () const =0`
- virtual `bool isReady () const =0`
- virtual `std::future< telux::common::Status > onReady ()=0`

#### 4.27.1.4.1 Constructors and Destructors

4.27.1.4.1.1 `virtual telux::cv2x::ICv2xRadio::~ICv2xRadio ( ) [virtual]`

Destructor for [ICv2xRadio](#)

#### 4.27.1.4.2 Member Function Documentation

4.27.1.4.2.1 `virtual bool telux::cv2x::ICv2xRadio::isInitialized ( ) const [pure virtual]`

Returns true if the radio interface has completed initialization.

##### Returns

True if initialized. False otherwise.

4.27.1.4.2.2 `virtual telux::common::Status telux::cv2x::ICv2xRadio::registerListener ( std::weak_ptr< ICv2xRadioListener > listener ) [pure virtual]`

Registers a listener for this Cv2xRadio.

##### Parameters

in	<i>listener</i>	- Listener that implements Cv2xRadioListener interface.
----	-----------------	---

4.27.1.4.2.3 `virtual telux::common::Status telux::cv2x::ICv2xRadio::deregisterListener ( std::weak_ptr< ICv2xRadioListener > listener ) [pure virtual]`

Deregisters a listener from this Cv2xRadio.

##### Parameters

in	<i>listener</i>	- Previously registered Cv2xRadioListener that is to be deregistered.
----	-----------------	---

4.27.1.4.2.4 `virtual telux::common::Status telux::cv2x::ICv2xRadio::createRxSubscription ( Traffic IpType ipType, uint16_t port, CreateRxSubscriptionCallback cb, std::shared_ptr< std::vector< uint32_t >> idList = nullptr ) [pure virtual]`

Creates and initializes a new Rx subscription which will be returned in the user-supplied callback.

**Parameters**

in	<i>ipType</i>	- IP traffic type (IP or NON-IP)
in	<i>port</i>	- Rx port number
in	<i>cb</i>	- Callback function that is invoked when socket creation is complete.
in	<i>idList</i>	- Service ID list to subscribe, optional parameter using nullptr by default. Subscribe wildcard if this parameter is set to nullptr.

On platforms with access control enabled, the caller needs to have TELUX\_CV2X\_FLOW\_OPS permission to successfully invoke this API.

**Returns**

SUCCESS on success. Error status otherwise.

**Dependencies** The interface must be pre-initialized with `init()`.

**4.27.1.4.2.5** `virtual telux::common::ServiceStatus telux::cv2x::ICv2xRadio::getServiceStatus ( )`  
`[pure virtual]`

This status indicates whether the Cv2xRadio is in a usable state.

**Returns**

SERVICE\_AVAILABLE - If `cv2x` radio is ready for service. SERVICE\_UNAVAILABLE - If `cv2x` radio is temporarily unavailable. SERVICE\_FAILED - If `cv2x` radio encountered an irrecoverable failure.

**4.27.1.4.2.6** `virtual telux::common::Status telux::cv2x::ICv2xRadio::enableRxMetaDataReport (`  
`TrafficIpType ipType, bool enable, std::shared_ptr< std::vector< std::uint32_t >> idList,`  
`telux::common::ResponseCallback cb ) [pure virtual]`

Enable or disable (depends on the parameter "bool enable") the received packets' meta data report for the service IDs provided.

The meta data consist of RF RSSI (received signal strength indicator) status, 32-bit SCI Format 1 (3GPP TS 36.213, section 14.1), packet delay estimation, L2 destination ID, and the resource blocks used for the packet's transmission: subframe, subchannel index.

On platforms with access control enabled, the caller needs to have TELUX\_CV2X\_INFO permission to successfully invoke this API.

**Parameters**

in	<i>ipType</i>	- IP traffic type (IP or NON-IP)
in	<i>enable</i>	- enable the rx meta data if set to true, otherwise disable
in	<i>idList</i>	- Service ID list of which the received packets' report are desired
in	<i>cb</i>	- Callback that is invoked when meta data is enabled or disabled.

**Returns**

SUCCESS if no error occurred

**Meta data report for IP packets is not supported yet, it will return NOSUPPORTED.**

**4.27.1.4.2.7** `virtual telux::common::Status telux::cv2x::ICv2xRadio::createTxSpsFlow ( TrafficIpType ipType, uint32_t serviceId, const SpsFlowInfo & spsInfo, uint16_t spsSrcPort, bool eventSrcPortValid, uint16_t eventSrcPort, CreateTxSpsFlowCallback cb ) [pure virtual]`

Creates a Tx SPS flow with the specified IP type, serviceId, and other parameters specified in reservation. Additionally, an option event flow will be created with the same IP type and serviceId. A Tx socket will be created and initialized for the SPS flow. A Tx socket will be created and initialized for the event flow if the optional event flow is specified.

On platforms with access control enabled, the caller needs to have TELUX\_CV2X\_FLOW\_OPS permission to successfully invoke this API.

**Parameters**

in	<i>ipType</i>	- IP traffic type (IP or NON-IP)
in	<i>serviceId</i>	- ID used for transmissions that will be mapped to an L2 destination address. Variable length 4-byte PSID or ITS_AID, or another service ID.
in	<i>spsInfo</i>	- SPS reservation parameters.
in	<i>spsSrcPort</i>	- Requested source port number for the bandwidth reserved SPS transmissions.
in	<i>eventSrcPortValid</i>	- True if an optional event flow is desired. If this field is left false, the event flow will not be created.
in	<i>eventSrcPort</i>	- Requested source port number for the optional event flow.
in	<i>cb</i>	- Callback function that is invoked when socket creation is complete. This must not be null.

**This caller is expected to identify two unused local port numbers**

to use for binding: one for the event-driven flow and one for the SPS flow.

**Returns**

SUCCESS upon success. Error status otherwise.

**4.27.1.4.2.8** `virtual telux::common::Status telux::cv2x::ICv2xRadio::createTxEventFlow ( TrafficIpType ipType, uint32_t serviceId, uint16_t eventSrcPort, CreateTxEventFlowCallback cb ) [pure virtual]`

Creates an event flow. An associated Tx socket will be created and initialized.

On platforms with access control enabled, the caller needs to have TELUX\_CV2X\_FLOW\_OPS permission to successfully invoke this API.

**Parameters**

in	<i>ipType</i>	- IP traffic type (IP or NON-IP)
in	<i>serviceId</i>	- ID used for transmissions that will be mapped to an L2 destination address. Variable length 4-byte PSID or ITS_AID, or another service ID.
in	<i>eventSrcPort</i>	- Local port number to which the socket is bound. Used for transmissions of this ID.
in	<i>cb</i>	- Callback function that is invoked when socket creation is complete. This must not be null.

**Detailed description This function is used only for TX when no periodicity is**

available for the application type. If your transmit data periodicity is known, use [createTxSpsFlow\(\)](#) instead.

**These even-driven sockets pay attention to the QoS parameters in**

the IP socket.

**Returns**

SUCCESS upon success. Error status otherwise.

**4.27.1.4.2.9** `virtual telux::common::Status telux::cv2x::ICv2xRadio::createTxEventFlow ( TrafficIpType ipType, uint32_t serviceId, const EventFlowInfo & flowInfo, uint16_t eventSrcPort, CreateTxEventFlowCallback cb ) [pure virtual]`

Creates an event flow. An associated Tx socket will be created and initialized.

On platforms with access control enabled, the caller needs to have TELUX\_CV2X\_FLOW\_OPS permission to successfully invoke this API.

**Parameters**

in	<i>ipType</i>	- IP traffic type (IP or NON-IP)
in	<i>serviceId</i>	- ID used for transmissions that will be mapped to an L2 destination address. Variable length 4-byte PSID or ITS_AID, or another service ID.
in	<i>flowInfo</i>	- Flow configuration parameters
in	<i>eventSrcPort</i>	- Local port number to which the socket is bound. Used for transmissions of this ID.
in	<i>cb</i>	- Callback function that is invoked when socket creation is complete. This must not be null.

**Detailed description This function is used only for TX when no periodicity is**

available for the application type. If your transmit data periodicity is known, use [createTxSpsFlow\(\)](#) instead.

**These even-driven sockets pay attention to the QoS parameters in**

the IP socket.

**Returns**

SUCCESS upon success. Error status otherwise.

**4.27.1.4.2.10** `virtual telux::common::Status telux::cv2x::ICv2xRadio::closeRxSubscription ( std::shared_ptr< ICv2xRxSubscription > rxSub, CloseRxSubscriptionCallback cb ) [pure virtual]`

Closes the RxSubscription and frees resources (such as the Rx socket) associated with it.

**Parameters**

in	<i>rxSub</i>	- RxSubscription to close
in	<i>cb</i>	- Callback that is invoked when socket close is complete. This may be null.

**Returns**

SUCCESS if no error occurred.

**4.27.1.4.2.11** `virtual telux::common::Status telux::cv2x::ICv2xRadio::closeTxFlow ( std::shared_ptr< ICv2xTxFlow > txFlow, CloseTxFlowCallback cb ) [pure virtual]`

Closes the TxFlow and frees resources associated with it (such as reserved SPS bandwidth contracts and sockets). This function works on both SPS and event flows.

On platforms with access control enabled, the caller needs to have TELUX\_CV2X\_FLOW\_OPS permission to successfully invoke this API.

**Parameters**

in	<i>txFlow</i>	- Tx (SPS or event) flow to close.
in	<i>cb</i>	- Callback that is invoked when Tx flow close is complete. This may be null.

**Returns**

SUCCESS if no error occurred.

**4.27.1.4.2.12** virtual telux::common::Status telux::cv2x::ICv2xRadio::changeSpsFlowInfo ( std::shared\_ptr< ICv2xTxFlow > *txFlow*, const SpsFlowInfo & *spsInfo*, ChangeSpsFlowInfoCallback *cb* ) [pure virtual]

Request to change TX SPS Flow reservation parameters.

**Parameters**

in	<i>txFlow</i>	- Tx SPS flow
in	<i>spsInfo</i>	- Desired SPS reservation parameters
in	<i>cb</i>	- Callback that is invoked upon reservation change. This may be null.

**Detailed description**

This function does not update reservation priority

**Returns**

SUCCESS if no error occurred.

**4.27.1.4.2.13** virtual telux::common::Status telux::cv2x::ICv2xRadio::requestSpsFlowInfo ( std::shared\_ptr< ICv2xTxFlow > *txFlow*, RequestSpsFlowInfoCallback *cb* ) [pure virtual]

Request SPS flow info.

**Parameters**

in	<i>txFlow</i>	- Tx SPS flow
in	<i>cb</i>	- Callback that will be invoked and returns the SPS info. Must not be null.

**Returns**

SUCCESS if no error occurred.



**4.27.1.4.2.14 virtual telux::common::Status telux::cv2x::ICv2xRadio::changeEventFlowInfo ( std::shared\_ptr< ICv2xTxFlow > txFlow, const EventFlowInfo & flowInfo, ChangeEventFlowInfoCallback cb ) [pure virtual]**

Request to change TX Event Flow reservation parameters.

On platforms with access control enabled, the caller needs to have TELUX\_CV2X\_FLOW\_OPS permission to successfully invoke this API.

#### Parameters

in	<i>txFlow</i>	- Tx Event flow
in	<i>flowInfo</i>	- Desired Event flow parameters
in	<i>cb</i>	- Callback that is invoked upon parameter change. This may be null.

#### Returns

SUCCESS if no error occurred.

**4.27.1.4.2.15 virtual telux::common::Status telux::cv2x::ICv2xRadio::requestCapabilities ( RequestCapabilitiesCallback cb ) [pure virtual]**

Request modem Cv2x capability information.

#### Parameters

in	<i>cb</i>	- Callback that will be invoked and returns the capability info. Must not be null.
----	-----------	--

#### Returns

SUCCESS if no error occurred.

**4.27.1.4.2.16 virtual telux::common::Status telux::cv2x::ICv2xRadio::requestDataSessionSettings ( RequestDataSessionSettingsCallback cb ) [pure virtual]**

Request data session settings currently in use.

#### Parameters

in	<i>cb</i>	- Callback that will be invoked and returns the data session settings. Must not be null.
----	-----------	--

#### Returns

SUCCESS if no error occurred.

#### 4.27.1.4.2.17 **virtual telux::common::Status telux::cv2x::ICv2xRadio::updateSrcL2Info ( UpdateSrcL2InfoCallback *cb* ) [pure virtual]**

Requests modem to change L2 info.

On platforms with access control enabled, the caller needs to have TELUX\_CV2X\_CONFIG permission to successfully invoke this API.

##### Parameters

in	<i>cb</i>	- Callback that will be invoked and returns status. Must not be null.
----	-----------	---

##### Returns

SUCCESS if no error occurred.

#### 4.27.1.4.2.18 **virtual telux::common::Status telux::cv2x::ICv2xRadio::updateTrustedUEList ( const TrustedUEInfoList & *infoList*, UpdateTrustedUEListCallback *cb* ) [pure virtual]**

Send request to modem to update the list of malicious UE source IDs and trusted UE source IDs with corresponding confidence information.

On platforms with access control enabled, the caller needs to have TELUX\_CV2X\_CONFIG permission to invoke this API successf

##### Parameters

in	<i>infoList</i>	- Trusted and malicious UE information list
in	<i>cb</i>	- Callback that will be invoked and returns status. Must not be null.

##### Returns

SUCCESS if no error occurred.

#### 4.27.1.4.2.19 **virtual std::string telux::cv2x::ICv2xRadio::getInterfaceNameFromIpType ( TrafficIpType *ipType* ) [pure virtual]**

Get interface name based on ipType.

##### Parameters

<i>ipType</i>	- IP traffic type (IP or NON-IP)
---------------	----------------------------------

##### Returns

Interface name as a string

**4.27.1.4.2.20 virtual telux::common::Status telux::cv2x::ICv2xRadio::createCv2xTcpSocket ( const EventFlowInfo & *eventInfo*, const SocketInfo & *sockInfo*, CreateTcpSocketCallback *cb* ) [pure virtual]**

Creates a CV2X TCP socket with specified event flow information and TCP socket information. The TCP socket will be created and bound to the IPv6 address of local IP interface with specified source port. Additionally, this API also registers a Tx event flow and subscribes Rx with specified service ID. If the created socket is expected to work as TCP client mode, the caller must connect the created socket to a destination using connect() and then use the socket for send() and recv() on successful connection. If the created socket is expected to work as TCP server mode, the caller must mark this socket as a listening socket using listen() and accept connections received from this listening socket using accept(), and then use the accepted sockets returned from accept() for send() or recv().

On platforms with access control enabled, the caller needs to have TELUX\_CV2X\_FLOW\_OPS permission to successfully invoke this API.

#### Parameters

in	<i>eventInfo</i>	- Information for the Event flow.
in	<i>sockInfo</i>	- Information for the TCP socket.
in	<i>cb</i>	- Callback function that is invoked when socket creation is complete. This must not be null.

**The caller is expected to identify an unused local port number as the source**

port number in structure [SocketInfo](#) to use for binding.

**The caller must release the created socket and associated resources with**

[closeCv2xTcpSocket](#). Additionally, if the created socket is marked as a listening socket, the caller must close all the accepted sockets returned by accept() using close() first, and then release the listening socket and associated resources by calling [closeCv2xTcpSocket](#).

#### Returns

SUCCESS upon success. Error status otherwise.

**4.27.1.4.2.21 virtual telux::common::Status telux::cv2x::ICv2xRadio::closeCv2xTcpSocket ( std::shared\_ptr< ICv2xTxRxSocket > *sock*, CloseTcpSocketCallback *cb* ) [pure virtual]**

Closes the CV2X TCP socket and frees resources associated with it (such as registered event Tx flow and subscribed Rx service ID and created TCP socket).

On platforms with access control enabled, the caller needs to have TELUX\_CV2X\_FLOW\_OPS permission to successfully invoke this API.

**Parameters**

in	<i>sock</i>	- CV2X TCP socket to close.
in	<i>cb</i>	- Callback that is invoked when CV2X TCP socket close is complete. This may be null.

**Returns**

SUCCESS if no error occurred.

**4.27.1.4.2.22** `virtual telux::common::Status telux::cv2x::ICv2xRadio::registerTxStatusReport↔  
Listener ( uint16_t port, std::shared_ptr< ICv2xTxStatusReportListener > listener,  
telux::common::ResponseCallback cb ) [pure virtual]`

Registers a listener for Tx status report.

**Parameters**

in	<i>port</i>	- Set this value to the port number of registered Tx Flow if user wants to receive Tx status report associated with its own Tx flow. If user wants to receive Tx status report associated with all Tx flows in system, set this value to 0.
in	<i>listener</i>	- Listener that implements <a href="#">ICv2xTxStatusReportListener</a> interface.
in	<i>cb</i>	- Callback that is invoked when the registration of CV2X Tx status report is complete.

**4.27.1.4.2.23** `virtual telux::common::Status telux::cv2x::ICv2xRadio::deregisterTxStatusReportListener  
( uint16_t port, telux::common::ResponseCallback cb ) [pure virtual]`

Deregisters a listener for Tx status report.

**Parameters**

in	<i>port</i>	- Port number of previously registered <a href="#">ICv2xTxStatusReport↔ Listener</a> that is to be deregistered. If the listener is registered with port number 0, set this value to 0 to deregister the listener.
in	<i>cb</i>	- Callback that is invoked when the deregistration of CV2X Tx status report is complete.

**4.27.1.4.2.24** `virtual telux::common::Status telux::cv2x::ICv2xRadio::setGlobalIPInfo ( const  
IPv6AddrType & ipv6Addr, common::ResponseCallback cb ) [pure virtual]`

Set CV2X global IP address for the IP interface.

Use case and Precondition: OBU: Registers a TX/RX *NON IP* flow for receiving the signed WSA/WRA for IP session initiation; Once receives the IP prefix in the WDS/WRA from RSU, call this method.

RSU: Specifies its own global prefix via this method, and creates/composes WSA/WRA advertising the IP

configs.

On platforms with access control enabled, the caller needs to have TELUX\_CV2X\_CONFIG permission to successfully invoke this API.

#### Parameters

in	<i>ipv6Addr</i>	- CV2X global IP address.
in	<i>cb</i>	- Callback that is invoked when set the global IP address complete. This may be null.

#### Returns

SUCCESS if no error occurred.

**4.27.1.4.2.25 virtual telux::common::Status telux::cv2x::!Cv2xRadio::setGlobalIPUnicastRoutingInfo ( const GlobalIPUnicastRoutingInfo & destL2Addr, common::ResponseCallback cb ) [pure virtual]**

Set CV2X IP interface global IP unicast routing information.

Use case and Precondition: OBU: Registers a TX/RX *NON IP* flow for receiving the signed WSA/WRA for IP session initiation; Once receives the IP prefix in the WSA/WRA from RSU, call the [setGlobalIPInfo](#) method to update the ip interface with global IP; Now call this method to set the routing information with dest L2 addr negotiated in WSA/WRA.

RSU: Specifies its own global prefix via [setGlobalIPInfo](#), and creates/composes WSA/WRA advertising the IP configs; Now set routing information of its own via this method.

On platforms with access control enabled, the caller needs to have TELUX\_CV2X\_CONFIG permission to successfully invoke this API.

#### Parameters

in	<i>destL2Addr</i>	- CV2X destination L2 address for unicast routing purpose.
in	<i>cb</i>	- Callback that is invoked when set global IP unicast routing information complete. This may be null.

#### Returns

SUCCESS if no error occurred.

**4.27.1.4.2.26** `virtual Cv2xRadioCapabilities telux::cv2x::ICv2xRadio::getCapabilities ( ) const [pure virtual]`

Get the capabilities of this Cv2xRadio.

#### Returns

[Cv2xRadioCapabilities](#) - Contains capabilities of this Cv2xRadio.

#### Deprecated

Use [requestCapabilities\(\)](#) API

**4.27.1.4.2.27** `virtual bool telux::cv2x::ICv2xRadio::isReady ( ) const [pure virtual]`

Returns true if the radio interface was successfully initialized.

#### Returns

True if ready. False otherwise.

#### Deprecated

use [getServiceStatus](#) instead

**4.27.1.4.2.28** `virtual std::future<telux::common::Status> telux::cv2x::ICv2xRadio::onReady ( ) [pure virtual]`

Returns a future that indicated if the radio interface is ready or if radio failed to initialize.

#### Returns

SUCCESS if Cv2xRadio initialization was successful. Otherwise it returns an Error Code.

#### Deprecated

the readiness can be notified via the callback passed to [ICv2xRadioManager::getCv2xRadio](#).

### 4.27.1.5 class telux::cv2x::ICv2xRadioListener

Listeners for Cv2xRadio must implement this interface.

#### Public member functions

- virtual void [onStatusChanged](#) (Cv2xStatus status)
- virtual void [onStatusChanged](#) (Cv2xStatusEx status)
- virtual void [onL2AddrChanged](#) (uint32\_t newL2Address)
- virtual void [onSpsOffsetChanged](#) (int spsId, [MacDetails](#) details)

- virtual void `onSpsSchedulingChanged` (const `SpsSchedulingInfo` &schedulingInfo)
- virtual void `onCapabilitiesChanged` (const `Cv2xRadioCapabilities` &capabilities)
- virtual void `onMacAddressCloneAttack` (const bool detected)
- virtual `~ICv2xRadioListener` ()

#### 4.27.1.5.1 Constructors and Destructors

**4.27.1.5.1.1** virtual `telux::cv2x::ICv2xRadioListener::~~ICv2xRadioListener` ( ) [`virtual`]

Destructor for `ICv2xRadioListener`

#### 4.27.1.5.2 Member Function Documentation

**4.27.1.5.2.1** virtual void `telux::cv2x::ICv2xRadioListener::onStatusChanged` ( `Cv2xStatus status` ) [`virtual`]

Called when the status of the CV2X radio has changed.

##### Parameters

<code>in</code>	<code>status</code>	- CV2X radio status.
-----------------	---------------------	----------------------

##### Deprecated

use `onStatusChanged` in `Cv2xListener`

**4.27.1.5.2.2** virtual void `telux::cv2x::ICv2xRadioListener::onStatusChanged` ( `Cv2xStatusEx status` ) [`virtual`]

Called when the status of the CV2X radio has changed.

##### Parameters

<code>in</code>	<code>status</code>	- CV2X radio status.
-----------------	---------------------	----------------------

##### Deprecated

use `onStatusChanged` in `Cv2xListener`

**4.27.1.5.2.3** virtual void `telux::cv2x::ICv2xRadioListener::onL2AddrChanged` ( `uint32_t newL2Address` ) [`virtual`]

Called when the L2 Address has changed.

**Parameters**

in	<i>newL2Address</i>	- The new L2 address.
----	---------------------	-----------------------

#### 4.27.1.5.2.4 virtual void telux::cv2x::ICv2xRadioListener::onSpsOffsetChanged ( int *spsId*, MacDetails *details* ) [virtual]

Called when SPS offset has changed.

**Parameters**

in	<i>spsId</i>	- SPS Id of the SPS flow
in	<i>details</i>	- new SPS MAC PHY details.

**Deprecated**

use onSpsSchedulingChanged

#### 4.27.1.5.2.5 virtual void telux::cv2x::ICv2xRadioListener::onSpsSchedulingChanged ( const SpsSchedulingInfo & *schedulingInfo* ) [virtual]

Called when SPS scheduling has changed.

**Parameters**

in	<i>schedulingInfo</i>	- SPS scheduling information .
----	-----------------------	--------------------------------

#### 4.27.1.5.2.6 virtual void telux::cv2x::ICv2xRadioListener::onCapabilitiesChanged ( const Cv2xRadioCapabilities & *capabilities* ) [virtual]

Called when Cv2x radio capabilities have changed.

**Parameters**

in	<i>capabilities</i>	- Capabilities of the CV2X radio .
----	---------------------	------------------------------------

#### 4.27.1.5.2.7 virtual void telux::cv2x::ICv2xRadioListener::onMacAddressCloneAttack ( const bool *detected* ) [virtual]

Called when a MAC address cloning attack is detected or cleared. MAC address collisions should be extremely rare. If they are happening frequently within a detection period, it will be identified as a MAC address cloning attack and users will be notified through this API. This API is also invoked when the attack is cleared. The collision count threshold and the detection period for MAC address cloning attack detection are configurable by setting parameter `cv2x.collision.threshold` and `cv2x.collision.window.size` in the file `/etc/tel.conf` on device.



**Parameters**

out	<i>detected</i>	- True when a MAC address cloning attack is detected. False when a MAC address cloning attack is cleared.
-----	-----------------	---

**4.27.1.6 class telux::cv2x::ICv2xRadioManager**

Cv2xRadioManager manages instances of Cv2xRadio.

**Public member functions**

- virtual bool `isReady` ()=0
- virtual std::future< bool > `onReady` ()=0
- virtual `telux::common::ServiceStatus` `getServiceStatus` ()=0
- virtual std::shared\_ptr< ICv2xRadio > `getCv2xRadio` (TrafficCategory category, `telux::common::InitResponseCb` cb=nullptr)=0
- virtual `telux::common::Status` `startCv2x` (StartCv2xCallback cb)=0
- virtual `telux::common::Status` `stopCv2x` (StopCv2xCallback cb)=0
- virtual `telux::common::Status` `requestCv2xStatus` (RequestCv2xStatusCallback cb)=0
- virtual `telux::common::Status` `requestCv2xStatus` (RequestCv2xStatusCallbackEx cb)=0
- virtual `telux::common::Status` `registerListener` (std::weak\_ptr< ICv2xListener > listener)=0
- virtual `telux::common::Status` `deregisterListener` (std::weak\_ptr< ICv2xListener > listener)=0
- virtual `telux::common::Status` `updateConfiguration` (const std::string &configFilePath, `UpdateConfigurationCallback` cb)=0
- virtual `telux::common::Status` `setPeakTxPower` (int8\_t txPower, `common::ResponseCallback` cb)=0
- virtual `telux::common::Status` `setL2Filters` (const std::vector< L2FilterInfo > &filterList, `common::ResponseCallback` cb)=0
- virtual `telux::common::Status` `removeL2Filters` (const std::vector< uint32\_t > &l2IdList, `common::ResponseCallback` cb)=0
- virtual `telux::common::Status` `getSlssRxInfo` (GetSlssRxInfoCallback cb)=0
- virtual `telux::common::Status` `injectCoarseUtcTime` (uint64\_t utc, `common::ResponseCallback` cb)=0
- virtual `~ICv2xRadioManager` ()

**4.27.1.6.1 Constructors and Destructors**

**4.27.1.6.1.1** virtual `telux::cv2x::ICv2xRadioManager::~~ICv2xRadioManager` ( ) [`virtual`]

**4.27.1.6.2 Member Function Documentation**

**4.27.1.6.2.1 virtual bool telux::cv2x::ICv2xRadioManager::isReady ( ) [pure virtual]**

Checks if the Cv2x Radio Manager is ready.

**Returns**

True if Cv2x Radio Manager is ready for service, otherwise returns false.

**Deprecated**

use getServiceStatus instead

**4.27.1.6.2.2 virtual std::future<bool> telux::cv2x::ICv2xRadioManager::onReady ( ) [pure virtual]**

Wait for Cv2x Radio Manager to be ready.

**Returns**

A future that caller can wait on to be notified when Cv2x Radio Manager is ready.

**Deprecated**

the readiness can be notified via the callback passed to [Cv2xFactory::getCv2xRadioManager](#).

**4.27.1.6.2.3 virtual telux::common::ServiceStatus telux::cv2x::ICv2xRadioManager::getServiceStatus ( ) [pure virtual]**

This status indicates whether the Cv2xRadioManager is in a usable state.

**Returns**

SERVICE\_AVAILABLE - If [cv2x](#) radio manager is ready for service. SERVICE\_UNAVAILABLE - If [cv2x](#) radio manager is temporarily unavailable. SERVICE\_FAILED - If [cv2x](#) radio manager encountered an irrecoverable failure.

**4.27.1.6.2.4 virtual std::shared\_ptr<ICv2xRadio> telux::cv2x::ICv2xRadioManager::getCv2xRadio ( TrafficCategory category, telux::common::InitResponseCb cb = nullptr ) [pure virtual]**

Get Cv2xRadio instance

**Parameters**

in	<i>category</i>	- Specifies the category of the client application. This field is currently unused.
in	<i>cb</i>	- Optional callback to get Cv2xRadio initialization status

**Returns**

Reference to Cv2xRadio interface that corresponds to the Cv2x Traffic Category specified.

#### 4.27.1.6.2.5 **virtual telux::common::Status telux::cv2x::ICv2xRadioManager::startCv2x ( StartCv2x↔ Callback *cb* ) [pure virtual]**

Put modem into CV2X mode.

On platforms with access control enabled, the caller needs to have TELUX\_CV2X\_OPS permission to successfully invoke this API.

**Parameters**

in	<i>cb</i>	- Callback that is invoked when Cv2x mode is started
----	-----------	--

**Returns**

SUCCESS on success. Error status otherwise.

#### 4.27.1.6.2.6 **virtual telux::common::Status telux::cv2x::ICv2xRadioManager::stopCv2x ( StopCv2x↔ Callback *cb* ) [pure virtual]**

Take modem out of CV2X mode

On platforms with access control enabled, the caller needs to have TELUX\_CV2X\_OPS permission to successfully invoke this API.

**Parameters**

in	<i>cb</i>	- Callback that is invoked when Cv2x mode is stopped
----	-----------	--

**Returns**

SUCCESS on success. Error status otherwise.

#### 4.27.1.6.2.7 **virtual telux::common::Status telux::cv2x::ICv2xRadioManager::requestCv2xStatus ( RequestCv2xStatusCallback *cb* ) [pure virtual]**

request CV2X status from modem

**Parameters**

in	<i>cb</i>	- Callback that is invoked when Cv2x status is retrieved
----	-----------	--

**Returns**

SUCCESS on success. Error status otherwise.

**Deprecated**

use requestCv2xStatus(RequestCv2xCallbackEx)

#### 4.27.1.6.2.8 virtual telux::common::Status telux::cv2x::ICv2xRadioManager::requestCv2xStatus ( RequestCv2xStatusCallbackEx *cb* ) [pure virtual]

request CV2X status from modem

**Parameters**

in	<i>cb</i>	- Callback that is invoked when Cv2x status is retrieved
----	-----------	--

**Returns**

SUCCESS on success. Error status otherwise.

#### 4.27.1.6.2.9 virtual telux::common::Status telux::cv2x::ICv2xRadioManager::registerListener ( std::weak\_ptr< ICv2xListener > *listener* ) [pure virtual]

Registers a listener for this manager.

**Parameters**

in	<i>listener</i>	- Listener that implements Cv2xListener interface.
----	-----------------	--

#### 4.27.1.6.2.10 virtual telux::common::Status telux::cv2x::ICv2xRadioManager::deregisterListener ( std::weak\_ptr< ICv2xListener > *listener* ) [pure virtual]

Deregisters a Cv2xListener for this manager.

**Parameters**

in	<i>listener</i>	- Previously registered CvListener that is to be deregistered.
----	-----------------	--

#### 4.27.1.6.2.11 virtual telux::common::Status telux::cv2x::ICv2xRadioManager::updateConfiguration ( const std::string & *configFilePath*, UpdateConfigurationCallback *cb* ) [pure virtual]

Updates CV2X configuration. Requires CV2X TX/RX radio status be Inactive. If CV2X radio status is Active or Suspended, call [stopCv2x](#) before updateConfiguration.

On platforms with access control enabled, the caller needs to have TELUX\_CV2X\_CONFIG permission to successfully invoke this API.

**Parameters**

in	<i>configFilePath</i>	- Path to config file.
in	<i>cb</i>	- Callback that is invoked when the send is complete. This may be null.

**Deprecated**

Use [ICv2xConfig](#) instead

#### 4.27.1.6.2.12 **virtual telux::common::Status telux::cv2x::ICv2xRadioManager::setPeakTxPower ( int8\_t txPower, common::ResponseCallback cb ) [pure virtual]**

Set RF peak *cv2x* transmit power. This affects the power for all existing flows and for any flow created in the future

On platforms with access control enabled, the caller needs to have TELUX\_CV2X\_CONFIG permission to successfully invoke this API.

**Parameters**

in	<i>txPower</i>	- Desired global Cv2x peak tx power in dbm
in	<i>cb</i>	- Callback that is invoked when Cv2x peak tx power is set

**Returns**

SUCCESS on success. Error status otherwise.

#### 4.27.1.6.2.13 **virtual telux::common::Status telux::cv2x::ICv2xRadioManager::setL2Filters ( const std::vector< L2FilterInfo > & filterList, common::ResponseCallback cb ) [pure virtual]**

Request to install remote UE src L2 filters. This affects receiving of the UEs' packets in specified period with specified PPPP

On platforms with access control enabled, the caller needs to have TELUX\_CV2X\_CONFIG permission to successfully invoke this API.

**Parameters**

in	<i>filterList</i>	- remote UE src L2 Id, filter duration and PPPP list, max size 50
in	<i>cb</i>	- Callback that is invoked when the request is sent

**Returns**

SUCCESS on success. Error status otherwise.

#### 4.27.1.6.2.14 **virtual telux::common::Status telux::cv2x::ICv2xRadioManager::removeL2Filters ( const std::vector< uint32\_t > & l2IdList, common::ResponseCallback cb ) [pure virtual]**

Remove the previously installed filters matching src L2 address list. Hence forth this would allow reception of packets from specified UE's

On platforms with access control enabled, the caller needs to have TELUX\_CV2X\_CONFIG permission to successfully invoke this API.

**Parameters**

in	<i>l2IdList</i>	- remote UE src L2 Id list, max size 50
in	<i>cb</i>	- Callback that is invoked when the request is sent

**Returns**

SUCCESS on success. Error status otherwise.

#### 4.27.1.6.2.15 **virtual telux::common::Status telux::cv2x::ICv2xRadioManager::getSlssRxInfo ( GetSlssRxInfoCallback *cb* ) [pure virtual]**

Get CV2X SLSS Rx information from modem.

On platforms with access control enabled, the caller needs to have TELUX\_CV2X\_INFO permission to successfully invoke this API.

**Parameters**

in	<i>cb</i>	- Callback that is invoked when Cv2x SLSS Rx information is retrieved.
----	-----------	--

**Returns**

SUCCESS on success. Error status otherwise.

#### 4.27.1.6.2.16 **virtual telux::common::Status telux::cv2x::ICv2xRadioManager::injectCoarseUtcTime ( uint64\_t *utc*, common::ResponseCallback *cb* ) [pure virtual]**

Inject coarse UTC time when UE is synchronized to SLSS.

GNSS fix is not available when UE is synchronized to SLSS. To get accurate UTC time in this case, user can register a listener by invoking [ICv2xRadioManager::registerListener](#) and then inject coarse UTC time derived from received application messages using this API. The age of injected UTC time could be nearly 10 seconds at most. After that, accurate UTC time will be notified to user periodically through the registered listener.

On platforms with access control enabled, the caller needs to have TELUX\_CV2X\_CONFIG permission to successfully invoke this API.

**Parameters**

in	<i>utc</i>	- UTC time since Jan. 1, 1970. Units: Milliseconds.
in	<i>cb</i>	- Callback that is invoked when UTC inject complete. This may be null.

**Returns**

SUCCESS if no error occurred.

#### 4.27.1.7 struct telux::cv2x::SyncRefUeInfo

Encapsulates parameters of an SLSS sync reference UE. Used in [SlssRxInfo](#).

##### Data fields

Type	Field	Description
uint16_t	slssId	The SLSS ID of the sync reference UE that is defined in 3GPP TS 36.331 chapter 6.3.8.
bool	inCoverage	Indicates whether or not the UE is in coverage of GNSS that is defined in 3GPP TS 36.331 chapter 6.5.2.
<a href="#">SlssSyncPattern</a>	pattern	Indicates the SLSS sync pattern of the UE that is defined in 3GPP TS 36.331 chapter 6.3.8.
uint8_t	rsrp	SLSS RSRP value of the UE in dBm is ((float)rsrp - 256)/2.
bool	selected	Indicates whether or not the sync reference UE has been selected as the timing source.

#### 4.27.1.8 struct telux::cv2x::SlssRxInfo

Encapsulates parameters of CV2X SLSS Rx Information.

Used in [telux::cv2x::ICv2xListener::onSlssRxInfoChanged](#).

##### Data fields

Type	Field	Description
vector< <a href="#">SyncRefUeInfo</a> >	ueInfo	Vector of detected SLSS sync reference UEs.

#### 4.27.1.9 struct telux::cv2x::SocketInfo

Encapsulates parameters of a CV2X socket.

Used in [ICv2xRadio::createCv2xTcpSocket](#).

##### Data fields

Type	Field	Description
uint32_t	serviceId	V2X service ID bound to the socket.
uint16_t	localPort	Local port number of the socket used for binding.

#### 4.27.1.10 struct telux::cv2x::Cv2xStatus

Encapsulates status of CV2X radio.

Used in [ICv2xRadioManager::requestCv2xStatus](#) and [ICv2xRadioListener](#).

**Data fields**

Type	Field	Description
<a href="#">Cv2xStatus</a> ↔ Type	rxStatus	RX status
<a href="#">Cv2xStatus</a> ↔ Type	txStatus	TX status
<a href="#">Cv2xCause</a> ↔ Type	rxCause	RX cause of failure
<a href="#">Cv2xCause</a> ↔ Type	txCause	TX cause of failure
uint8_t	cbrValue	Channel Busy Ratio
bool	cbrValueValid	CBR value is valid

**4.27.1.11 struct telux::cv2x::Cv2xPoolStatus**

Encapsulates status for single pool.

Used in [Cv2xStatusEx](#).

**Data fields**

Type	Field	Description
uint8_t	poolId	pool ID
<a href="#">Cv2xStatus</a>	status	status

**4.27.1.12 struct telux::cv2x::Cv2xStatusEx**

Encapsulates status of CV2X radio and per pool status.

Used in [ICv2xRadioManager::requestCv2xStatus](#) and [Cv2xRadioListener](#).

**Data fields**

Type	Field	Description
<a href="#">Cv2xStatus</a>	status	Overall Cv2x status
vector< <a href="#">Cv2xPool</a> ↔ <a href="#">Status</a> >	poolStatus	Multi pool status vector
bool	<a href="#">time</a> ↔ <a href="#">Uncertainty</a> ↔ Valid	Time uncertainty value is valid
float	<a href="#">time</a> ↔ Uncertainty	Time uncertainty value in milliseconds



#### 4.27.1.13 struct telux::cv2x::TxPoolIdInfo

Contains minimum and maximum EARFCNs for a given Tx pool ID. Multiple Tx Pools allow the same radio and overall frequency range to be shared for multiple types of traffic like V2V and V2X. Each pool ID and frequency range corresponds to a certain type of traffic. Both edge guard bands are not included in the EARFCN range reported. The calculation for the full bandwidth includes both edge guard bands is:  

$$\text{bandwidth(MHz)} = (\text{maxFreq} - \text{minFreq}) / 9.$$

Used in [Cv2xRadioCapabilities](#)

##### Data fields

Type	Field	Description
uint8_t	poolId	TX pool ID.
uint16_t	minFreq	Minimum EARFCN of this pool.
uint16_t	maxFreq	Maximum EARFCN of this pool.

#### 4.27.1.14 struct telux::cv2x::EventFlowInfo

Contains event flow configuration parameters.

Used in [ICv2xRadio::createTxEventFlow](#)

##### Data fields

Type	Field	Description
bool	autoRetrans↔ EnabledValid	Set to true if autoRetransEnabled field is specified. If false, the system will use the default setting.
bool	autoRetrans↔ Enabled	Used to enable automatic-retransmissions.
bool	peakTxPower↔ Valid	Set to true if peakTxPower is used. If false, the system will use the default setting.
int32_t	peakTxPower	Max Tx power setting in dBm.
bool	mcsIndexValid	Set to true if mcsIndex is used. If false, the system will use its default setting.
uint8_t	mcsIndex	Modulation and Coding Scheme Index to use.
bool	txPoolIdValid	Set to true if txPoolId is used. If false, the system will use its default setting.
uint8_t	txPoolId	Transmission Pool ID.
bool	isUnicast	Set to true if isUnicast flow. If false, Non-Unicast flow will be created. Note: Unicast flows ignore subscribed Service Ids

#### 4.27.1.15 struct telux::cv2x::SpsFlowInfo

Used to request the QoS bandwidth contract, implemented in PC5 3GPP V2X radio as a *Semi Persistent Flow* (SPS).

The underlying radio providing the interface might support periodicities of various granularity in 100ms integer multiples (e.g. 200ms, 300ms).

Used in [ICv2xRadio::createTxSpsFlow](#) and [ICv2xRadio::changeSpsFlowInfo](#)

**Data fields**

Type	Field	Description
<a href="#">Priority</a>	priority	Specifies one of the 3GPP levels of Priority for the traffic that is pre-reserved on the SPS flow. Default is PRIORITY_2. Use getCapabilities() to discover the supported priority levels.  <b>Deprecated</b>  : periodicity, Use new periodicityMs instead
<a href="#">Periodicity</a>	periodicity	
uint64_t	periodicityMs	This is the new interface to specify periodicity in milliseconds for <a href="#">SpsFlowInfo</a> . Enum Periodicity is deprecated and will be removed in future release. Bandwidth-reserved periodicity interval in interval in milliseconds.  There are limits on which intervals the underlying radio supports. Use getCapabilities() to discover minPeriodicityMultiplierMs and maximumPeriodicityMs.
uint32_t	nbytesReserved	Number of bytes of TX bandwidth that are sent every periodicity interval.
bool	autoRetrans↔ EnabledValid	Set to true if autoRetransEnabled field is specified. If false, the system will use the default setting.
bool	autoRetrans↔ Enabled	Used to enable automatic-retransmissions.
bool	peakTxPower↔ Valid	Set to true if peakTxPower is used. If false, the system will use the default setting.
int32_t	peakTxPower	Max Tx power setting in dBm.
bool	mcsIndexValid	Set to true if mcsIndex is used. If false, the system will use its default setting.
uint8_t	mcsIndex	Modulation and Coding Scheme Index to use.
bool	txPoolIdValid	Set to true if txPoolId is used. If false, the system will use its default setting.
uint8_t	txPoolId	Transmission Pool ID.

**4.27.1.16 struct telux::cv2x::Cv2xRadioCapabilities**

Contains capabilities of the Cv2xRadio.

Used in [ICv2xRadio::requestCapabilities](#) and [ICv2xRadioListener::onCapabilitiesChanged](#)

**Data fields**

Type	Field	Description
uint32_t	linkIpMtuBytes	Maximum data payload length (in bytes) of a packet supported by the IP Radio interface.
uint32_t	linkNonIp↔ MtuBytes	Maximum data payload length (in bytes) of a packet supported by the non-IP Radio interface.

Type	Field	Description
<a href="#">Radio↔ Concurrency↔ Mode</a>	max↔ Supported↔ Concurrency	Indicates whether this interface supports concurrent WWAN with V2X (PC5).
uint16_t	nonIpTx↔ Payload↔ OffsetBytes	Byte offset in a non-IP Tx packet before the actual payload begins.
uint16_t	nonIpRx↔ Payload↔ OffsetBytes	Byte offset in a non-IP Rx packet before the actual payload begins.  <b>Deprecated</b>  : periodicitiesSupported, Use new periodicities instead
bitset< 8 >	periodicities↔ Supported	
vector< uint64_t >	periodicities	Specifies the periodicities supported
uint8_t	maxNum↔ Auto↔ Retransmissions	Least frequent bandwidth periodicity that is supported. Above this value, use event-driven periodic messages of a period larger than this value.
uint8_t	layer2Mac↔ AddressSize	Size of the L2 MAC address.  Different Radio Access Technologies have different-sized L2 MAC addresses: 802.11 has 6 bytes, whereas 3GPP PC5 has only 3 bytes. Because a randomized MAC address comes from an HSM with good pseudo random entropy, higher layers must know how many bytes of the MAC address to generate.
bitset< 8 >	priorities↔ Supported	Bit set of different priority levels supported by this Cv2xRadio. Refer to <a href="#">Priority</a>
uint16_t	maxNumSps↔ Flows	Maximum number of supported SPS reservations.
uint16_t	maxNumNon↔ SpsFlows	Maximum number of supported event flows (non-SPS ports).
int32_t	maxTxPower	Maximum supported transmission power.
int32_t	minTxPower	Minimum supported transmission power.
vector< <a href="#">Tx↔ PoolIdInfo</a> >	txPoolIds↔ Supported	Vector of supported transmission pool IDs.
uint8_t	isUnicast↔ Supported	Non zero value if UDP event unicast is supported.

#### 4.27.1.17 struct telux::cv2x::MacDetails

Contains MAC information that is reported from the actual MAC SPS in the radio. The offsets can periodically change on any given transmission report.

##### Data fields

Type	Field	Description
uint32_t	periodicityIn↔ UseNs	Actual transmission interval period (in nanoseconds) scheduled relative to 1PP 0:00.00 time

Type	Field	Description
uint16_t	currently↔ Reserved↔ PeriodicBytes	Actual number of bytes currently reserved at the MAC layer. This number can be slightly larger than original request.
uint32_t	txReservation↔ OffsetNs	Actual offset, from a 1PPS pulse and TX flow periodicity, that the MAC selected and is using for the transmit reservation. If the data goes to the radio with enough time, it can be transmitted on the medium in the next immediately scheduled slot.

#### 4.27.1.18 struct telux::cv2x::SpsSchedulingInfo

Contains SPS packet scheduling information that is reported from the radio.

Used in [ICv2xRadioListener::onSpsSchedulingChanged](#)

##### Data fields

Type	Field	Description
uint8_t	spsId	SPS ID
uint64_t	utcTime	Absolute UTC start time of next selected grant in nanoseconds.
uint32_t	periodicity	Periodicity of the grant in milliseconds.

#### 4.27.1.19 struct telux::cv2x::TrustedUEInfo

Contains time confidence, position confidence, and propagation delay for a trusted UE.

Used in [TrustedUEInfo](#)

##### Data fields

Type	Field	Description
uint32_t	sourceL2Id	Trusted Source L2 ID
float	time↔ Uncertainty	Time uncertainty value in milliseconds.
uint16_t	time↔ Confidence↔ Level	<b>Deprecated</b>  Use timeUncertainty Time confidence level. Range from 0 to 127 with 0 being invalid/unavailable and 127 being the most confident.
uint16_t	position↔ Confidence↔ Level	Position confidence level. Range from 0 to 127 with 0 being invalid/unavailable and 127 being the most confident.
uint32_t	propagation↔ Delay	Propagation delay in microseconds.

#### 4.27.1.20 struct telux::cv2x::TrustedUEInfoList

Contains list of malicious UE source L2 IDs. Contains list of trusted UE source L2 IDs and associated confidence values.

Used in [ICv2xRadio::updateTrustedUEList](#)

##### Data fields

Type	Field	Description
bool	maliciousIds↔ Valid	Malicious remote UE sources are valid.
vector< uint32_t >	maliciousIds	Malicious remote UE source L2 IDs.
bool	trustedUEs↔ Valid	Trusted remote UE sources are valid.
vector< <a href="#">TrustedUE↔ Info</a> >	trustedUEs	Trusted remote UE sources.

#### 4.27.1.21 struct telux::cv2x::IPv6Address

Contains IPv6 address.

Used in [DataSessionSettings](#)

##### Data fields

Type	Field	Description
uint8_t	addr[16]	

#### 4.27.1.22 struct telux::cv2x::DataSessionSettings

Contains packet data session settings.

Used in [ICv2xRadio::requestDataSessionSettings](#)

##### Data fields

Type	Field	Description
bool	mtuValid	Set to true if mtu is valid.
uint32_t	mtu	MTU size.
bool	ipv6AddrValid	Set to true if ipv6 address is valid.
<a href="#">IPv6Address</a>	ipv6Addr	IPv6 address.

#### 4.27.1.23 struct telux::cv2x::ConfigEventInfo

Information about any update to a CV2X config file.

Used in [ICv2xConfigListener::onConfigChanged](#)

**Data fields**

Type	Field	Description
<a href="#">ConfigSourceType</a>	source	The type of the V2X config file.
<a href="#">ConfigEvent</a>	event	V2X config event.

**4.27.1.24 struct telux::cv2x::L2FilterInfo**

Contains remote UE source L2 ID that modem will drop on Rx.

Used in [ICv2xRadioManager::setL2Filters](#)

**Data fields**

Type	Field	Description
uint32_t	srcL2Id	< remote UE L2 MAC addr to filter. Duration, in millisecond (resolution 100 msec). 0 means delete the filter.
uint32_t	durationMs	/* Proximity service per packet priority (PPPP), packets with priority above this value will be dropped. Range 0-7, 0 mean all priority pkts from that UE would be dropped.
uint8_t	pppp	

**4.27.1.25 struct telux::cv2x::RFTxInfo**

Tx status per Tx chain and Tx power per Tx antenna for a specific transport block.

Used in [TxStatusReport](#)

**Data fields**

Type	Field	Description
<a href="#">RFTxStatus</a>	status	Fault detection status for a specific Tx chain.
int32_t	power	The target Tx power after MPR/AMPR reduction for a specific Tx antenna in dBm*10 format. Invalid value is -700, it means the corresponding antenna is not being used for the transmission of this transport block.

**4.27.1.26 struct telux::cv2x::TxStatusReport**

Information on Tx status of a V2X transport block that is reported from low layer.

1. A V2X packet might trigger multiple reports because of the segmentation and re-Tx in low layer.
2. If a transport block is dropped in low layer, no report will be triggered for that transport block.
3. The power in the array of rfInfo is the target Tx power value in dBm\*10 after MPR/AMPR reduction for a specific Tx antenna. The status in the array of rfInfo is the fault detection status for a specific Tx chain.
  - In CDD mode, two antennas are being used for a specific transport block, both rfInfo[0].power

and `rfInfo[1].power` are valid (not -700), `rfInfo[i].status` is reflecting the status of Tx chain/Tx antenna `i`.

- In TXD mode, data transmission switches between two antennas/chains and only one antenna/chain is being used for a specific transport block, the Tx antenna being used has valid power (not -700) in the array of `rfInfo`, `rfInfo[i].status` is reflecting the status of Tx chain `i` or the status of the Tx antenna `i` whose power is valid (not -700) in the array of `rfInfo`. Used in [ICv2xTxStatusReportListener::onTxStatusReport](#)

#### Data fields

Type	Field	Description
<a href="#">RFTxInfo</a>	<code>rfInfo[<a href="#">MAX_↔ ANTENNAS_↔ _SUPPORT_↔ ED</a>]</code>	Tx status per Tx chain and Tx power per Tx antenna.
<code>uint8_t</code>	<code>numRb</code>	Number of resource blocks used for the transport block.
<code>uint8_t</code>	<code>startRb</code>	Start resource block index used for the transport block.
<code>uint8_t</code>	<code>mcs</code>	Modulation and coding scheme used for the transport block that is defined in 3GPP TS 36.213.
<code>uint8_t</code>	<code>segNum</code>	Total number of segments of a V2X packet.
<a href="#">SegmentType</a>	<code>segType</code>	Segment type of the transport block.
<a href="#">TxType</a>	<code>txType</code>	Indication of new Tx or re-Tx of the transport block.
<code>uint16_t</code>	<code>otaTiming</code>	OTA timing in format of system frame number*10 + subframe number.
<code>uint16_t</code>	<code>port</code>	Port number that can be used to link the report to a specific Tx flow which has the same source port number.

#### 4.27.1.27 struct `telux::cv2x::IPv6AddrType`

Encapsulates ipv6 prefix length in bits and ipv6 prefix.

Used in [ICv2xRadio::setGlobalIPInfo](#).

#### Data fields

Type	Field	Description
<code>uint8_t</code>	<code>prefixLen</code>	< ipv6 address prefix length in bits, range [64, 128]
<code>uint8_t</code>	<code>ipv6Addr[<a href="#">C_↔ V2X_IPV6_↔ ADDR_ARR_↔ AY_LEN</a>]</code>	

#### 4.27.1.28 struct `telux::cv2x::GlobalIPUnicastRoutingInfo`

Encapsulates destination L2 address.

Used in [ICv2xRadio::setGlobalIPUnicastRoutingInfo](#).

**Data fields**

Type	Field	Description
uint8_t	destMac↔ Addr[CV2X_↔ MAC_ADD↔ R_LEN]	< Array that stores CV2X L2 MAC address at the last 3 bytes in big endian order.

**4.27.1.29 struct telux::cv2x::RxPacketMetaDataReport**

Contains the detailed meta data report of a packet received.

The meta data report comes from the same data interface as the packet itself, it consist of RF RSSI (received signal strength indicator) status, 32-bit SCI Format 1 (3GPP TS 36.213, section 14.1), packet delay estimation, L2 destination ID, and the resource blocks used for the packet's transmission: subframe, subchannel index.

The meta data is always received after the successful receipt of the corresponding packet. In order to associate the meta data report with the specific packet, the sfn and subChannelIndex should be present in the packet's payload and the meta data report, so the meta data report can be matched up to the packet.

There is no guarantee that all items listed above will be presented, [metaDataMask](#) need to be used for the validity. Use [telux::cv2x::Cv2xRxMetaDataHelper::getRxMetaDataInfo](#) to extract the meta data.

**Data fields**

Type	Field	Description
<a href="#">RxMetaData↔ Validity</a>	metaDataMask	
uint16_t	sfn	
uint8_t	subChannel↔ Index	
uint8_t	subChannel↔ Num	
int8_t	prxRssi	
int8_t	drxRssi	
uint32_t	l2DestinationId	
uint32_t	sciFormat1Info	
int32_t	delay↔ Estimation	

**4.27.1.30 class telux::cv2x::Cv2xRxMetaDataHelper****Static Public Member Functions**

- static [telux::common::Status](#) [getRxMetaDataInfo](#) (const uint8\_t \*payload, uint32\_t payloadLength, size\_t &metaDataLen, std::shared\_ptr< std::vector< [RxPacketMetaDataReport](#) >> metaDatas)



### 4.27.1.30.1 Member Function Documentation

4.27.1.30.1.1 `static telux::common::Status telux::cv2x::Cv2xRxMetaDataHelper::getRxMetaDataInfo ( const uint8_t * payload, uint32_t payloadLength, size_t & metaDataLen, std::shared_ptr< std::vector< RxPacketMetaDataReport >> metaDatas ) [static]`

### 4.27.1.31 class telux::cv2x::ICv2xRxSubscription

This class encapsulates a Cv2xRadio Rx Subscription. It contains the Rx socket associated with the subscription from which client applications can read data. This class is referenced in [ICv2xRadio::createRxSubscription](#) and [ICv2xRadio::closeRxSubscription](#).

#### Public member functions

- virtual `uint32_t getSubscriptionId () const =0`
- virtual `TrafficIpType getIpType () const =0`
- virtual `int getSock () const =0`
- virtual `struct sockaddr_in6 getSockAddr () const =0`
- virtual `uint16_t getPortNum () const =0`
- virtual `std::shared_ptr< std::vector< uint32_t >> getServiceIDList () const =0`
- virtual `void setServiceIDList (const std::shared_ptr< std::vector< uint32_t >> idList)=0`
- virtual `~ICv2xRxSubscription ()`

### 4.27.1.31.1 Constructors and Destructors

4.27.1.31.1.1 `virtual telux::cv2x::ICv2xRxSubscription::~ICv2xRxSubscription ( ) [virtual]`

### 4.27.1.31.2 Member Function Documentation

4.27.1.31.2.1 `virtual uint32_t telux::cv2x::ICv2xRxSubscription::getSubscriptionId ( ) const [pure virtual]`

Accessor for Rx subscription ID

#### Returns

subscription ID

4.27.1.31.2.2 `virtual TrafficIpType telux::cv2x::ICv2xRxSubscription::getIpType ( ) const [pure virtual]`

Accessor for IP traffic type

#### Returns

The Rx subscriptions's IP traffic type (IP or NON-IP)

**4.27.1.31.2.3** `virtual int telux::cv2x::ICv2xRxSubscription::getSock ( ) const [pure virtual]`

Accessor for the socket file descriptor

**Returns**

The Rx subscriptions's socket fd.

**4.27.1.31.2.4** `virtual struct sockaddr_in6 telux::cv2x::ICv2xRxSubscription::getSockAddr ( ) const [pure virtual]`

Accessor for the socket address description

**Returns**

The Rx subscriptions's socket address

**4.27.1.31.2.5** `virtual uint16_t telux::cv2x::ICv2xRxSubscription::getPortNum ( ) const [pure virtual]`

Accessor for the subscriptions's port number

**Returns**

The Rx subscriptions's port num

**4.27.1.31.2.6** `virtual std::shared_ptr<std::vector<uint32_t> > telux::cv2x::ICv2xRxSubscription::getServiceIDList ( ) const [pure virtual]`

Get subscriptions's service ID list

**Returns**

The Rx subscriptions's service ID list

**4.27.1.31.2.7** `virtual void telux::cv2x::ICv2xRxSubscription::setServiceIDList ( const std::shared_ptr<std::vector< uint32_t >> idList ) [pure virtual]`

Set subscriptions's service ID list

**Parameters**

in	<i>idList</i>	- the subscriptions's service ID list
----	---------------	---------------------------------------

**4.27.1.32** `class telux::cv2x::ICv2xThrottleManagerListener`

Listener class for getting filter rate update notification.

**Public member functions**

- virtual void [onFilterRateAdjustment](#) (int rate)
- virtual void [onServiceStatusChange](#) ([telux::common::ServiceStatus](#) status)
- virtual void [onSanityStateUpdate](#) (bool state)
- virtual [~ICv2xThrottleManagerListener](#) ()

**4.27.1.32.1 Constructors and Destructors**

**4.27.1.32.1.1** virtual [telux::cv2x::ICv2xThrottleManagerListener::~~ICv2xThrottleManagerListener](#) ( )  
[virtual]

Destructor of [ICv2xThrottleManagerListener](#)

**4.27.1.32.2 Member Function Documentation**

**4.27.1.32.2.1** virtual void [telux::cv2x::ICv2xThrottleManagerListener::onFilterRateAdjustment](#) ( int *rate* ) [virtual]

This API is invoked to advise the client to adjust the incoming message filtering rate by *rate* messages/second. If the *rate* is positive, it indicates the client to filter *rate* more messages/second. If the *rate* is negative, it indicates the client to filter *rate* less messages/second.

**Parameters**

in	<i>rate</i>	the reported filter rate adjustment value.
----	-------------	--

**4.27.1.32.2.2** virtual void [telux::cv2x::ICv2xThrottleManagerListener::onServiceStatusChange](#) ( [telux::common::ServiceStatus](#) *status* ) [virtual]

This API is invoked when the service status changes for example when a subsystem restart (SSR) occurs

**Parameters**

in	<i>status</i>	- <a href="#">telux::common::ServiceStatus</a>
----	---------------	--

**4.27.1.32.2.3** virtual void [telux::cv2x::ICv2xThrottleManagerListener::onSanityStateUpdate](#) ( bool *state* ) [virtual]

This API is invoked when capacity of underlying message verification module is tampered

**Parameters**

in	<i>state</i>	- mvm state, true if mvm is in good state, otherwise false.
----	--------------	---

**Note**

Eval: This is a new API and is being evaluated. It is subject to change and could break backwards compatibility.

**4.27.1.33 class telux::cv2x::ICv2xThrottleManager**

ThrottleManager provides throttle manager client interface.

ThrottleManager provides APIs that allows applications to specify the incoming verification load on the system. This is used to make decisions on how to optimally use the resources available in the system. The API also provides feedback to clients on the suggested filtering that needs to be done when the incoming message verification rate exceeds the instantaneous system capacity.

**Public member functions**

- virtual [telux::common::ServiceStatus](#) [getServiceStatus](#) ()=0
- virtual [telux::common::Status](#) [registerListener](#) (std::weak\_ptr< [ICv2xThrottleManagerListener](#) > listener)=0
- virtual [telux::common::Status](#) [deregisterListener](#) (std::weak\_ptr< [ICv2xThrottleManagerListener](#) > listener)=0
- virtual [telux::common::Status](#) [setVerificationLoad](#) (int load, [setVerificationLoadCallback](#) cb)=0
- virtual [~ICv2xThrottleManager](#) ()

**4.27.1.33.1 Constructors and Destructors**

**4.27.1.33.1.1** virtual [telux::cv2x::ICv2xThrottleManager::~ICv2xThrottleManager](#) ( ) [[virtual](#)]

**4.27.1.33.2 Member Function Documentation**

**4.27.1.33.2.1** virtual [telux::common::ServiceStatus](#) [telux::cv2x::ICv2xThrottleManager::getService↔Status](#) ( ) [[pure virtual](#)]

This status indicates whether the object is in a usable state.

**Returns**

SERVICE\_AVAILABLE - If location manager is ready for service. SERVICE\_UNAVAILABLE - If location manager is temporarily unavailable. SERVICE\_FAILED - If location manager encountered an irrecoverable failure.

**4.27.1.33.2.2** virtual [telux::common::Status](#) [telux::cv2x::ICv2xThrottleManager::registerListener](#) ( std::weak\_ptr< [ICv2xThrottleManagerListener](#) > *listener* ) [[pure virtual](#)]

Registers a listener to receive the updated filer rate adjustment data.

**Parameters**

in	<i>listener</i>	- Listener that implement <a href="#">ICv2xThrottleManagerListener</a> interface.
----	-----------------	---

**4.27.1.33.2.3** virtual `telux::common::Status telux::cv2x::ICv2xThrottleManager::deregisterListener ( std::weak_ptr< ICv2xThrottleManagerListener > listener ) [pure virtual]`

Deregister a [ICv2xThrottleManagerListener](#).

**Parameters**

in	<i>listener</i>	- Previously registered <code>Cv2xThrottleManagerListener</code> that is deregistered.
----	-----------------	--

**4.27.1.33.2.4** virtual `telux::common::Status telux::cv2x::ICv2xThrottleManager::setVerificationLoad ( int load, setVerificationLoadCallback cb ) [pure virtual]`

Set current measured/average verification load.

**Parameters**

in	<i>load</i>	- current measured verification load(verification/second).
in	<i>cb</i>	- callack for indicating the result of set verification load.

**4.27.1.34 class telux::cv2x::ICv2xTxFlow**

This is class encapsulates a `Cv2xRadio` Tx flows. It contains the Tx socket associated with the flow through which client applications can send data. This class is referenced in [ICv2xRadio::createTxSpsFlow](#), [ICv2xRadio::createTxEventFlow](#), and [ICv2xRadio::closeTxFlow](#)

**Public member functions**

- virtual `uint32_t getFlowId () const =0`
- virtual `TrafficIpType getIpType () const =0`
- virtual `uint32_t getServiceId () const =0`
- virtual `int getSock () const =0`
- virtual `struct sockaddr_in6 getSockAddr () const =0`
- virtual `uint16_t getPortNum () const =0`
- virtual `~ICv2xTxFlow ()`

#### 4.27.1.34.1 Constructors and Destructors

4.27.1.34.1.1 `virtual telux::cv2x::ICv2xTxFlow::~~ICv2xTxFlow ( ) [virtual]`

#### 4.27.1.34.2 Member Function Documentation

4.27.1.34.2.1 `virtual uint32_t telux::cv2x::ICv2xTxFlow::getFlowId ( ) const [pure virtual]`

Accessor for flow ID. The flow ID should be unique within a process but will not be unique between processes.

##### Returns

flow ID

4.27.1.34.2.2 `virtual TrafficIpType telux::cv2x::ICv2xTxFlow::getIpType ( ) const [pure virtual]`

Accessor for IP traffic type

##### Returns

The flow's IP traffic type (IP or NON-IP)

4.27.1.34.2.3 `virtual uint32_t telux::cv2x::ICv2xTxFlow::getServiceId ( ) const [pure virtual]`

Accessor for service ID

##### Returns

The flow's Service ID.

4.27.1.34.2.4 `virtual int telux::cv2x::ICv2xTxFlow::getSock ( ) const [pure virtual]`

Accessor for the socket file descriptor

##### Returns

The flow's socket fd.

4.27.1.34.2.5 `virtual struct sockaddr_in6 telux::cv2x::ICv2xTxFlow::getSockAddr ( ) const [pure virtual]`

Accessor for the socket address description

##### Returns

The flow's socket address

#### 4.27.1.34.2.6 virtual uint16\_t telux::cv2x::ICv2xTxFlow::getPortNum ( ) const [pure virtual]

Accessor for the flow's source port number

#### Returns

The flow's source port num

#### 4.27.1.35 class telux::cv2x::ICv2xTxRxSocket

This class encapsulates a Cv2xRadio socket for both Tx and Rx. It contains the socket through which client applications can send and receive data. This class is referenced in [ICv2xRadio::createCv2xTcpSocket](#) and [ICv2xRadio::closeCv2xTcpSocket](#).

#### Public member functions

- virtual uint32\_t [getId](#) ( ) const =0
- virtual uint32\_t [getServiceId](#) ( ) const =0
- virtual int [getSocket](#) ( ) const =0
- virtual struct sockaddr\_in6 [getSocketAddr](#) ( ) const =0
- virtual uint16\_t [getPortNum](#) ( ) const =0
- virtual [~ICv2xTxRxSocket](#) ( )

#### 4.27.1.35.1 Constructors and Destructors

##### 4.27.1.35.1.1 virtual telux::cv2x::ICv2xTxRxSocket::~~ICv2xTxRxSocket ( ) [virtual]

#### 4.27.1.35.2 Member Function Documentation

##### 4.27.1.35.2.1 virtual uint32\_t telux::cv2x::ICv2xTxRxSocket::getId ( ) const [pure virtual]

Accessor for Cv2xRadio socket ID. The socket ID should be unique within a process but will not be unique between processes.

#### Returns

Cv2xRadio socket ID

##### 4.27.1.35.2.2 virtual uint32\_t telux::cv2x::ICv2xTxRxSocket::getServiceId ( ) const [pure virtual]

Accessor for service ID

#### Returns

The Service ID bound to the socket.

#### 4.27.1.35.2.3 `virtual int telux::cv2x::ICv2xTxRxSocket::getSocket ( ) const [pure virtual]`

Accessor for the socket file descriptor

##### Returns

The socket fd.

#### 4.27.1.35.2.4 `virtual struct sockaddr_in6 telux::cv2x::ICv2xTxRxSocket::getSocketAddr ( ) const [pure virtual]`

Accessor for the socket address description

##### Returns

The socket address

#### 4.27.1.35.2.5 `virtual uint16_t telux::cv2x::ICv2xTxRxSocket::getPortNum ( ) const [pure virtual]`

Accessor for the local port number bound to the socket

##### Returns

The local port number

### 4.27.1.36 `class telux::cv2x::ICv2xTxStatusReportListener`

Listeners for CV2X Tx status report must implement this interface.

#### Public member functions

- virtual void `onTxStatusReport` (const `TxStatusReport` &info)
- virtual `~ICv2xTxStatusReportListener` ()

#### 4.27.1.36.1 Constructors and Destructors

##### 4.27.1.36.1.1 `virtual telux::cv2x::ICv2xTxStatusReportListener::~~ICv2xTxStatusReportListener ( ) [virtual]`

Destructor for `ICv2xTxStatusReportListener`

#### 4.27.1.36.2 Member Function Documentation



#### 4.27.1.36.2.1 virtual void telux::cv2x::ICv2xTxStatusReportListener::onTxStatusReport ( const TxStatusReport & *info* ) [virtual]

Called when a CV2X transport block is transmitted in low layer if a listener for Tx status report has been registered by calling [ICv2xRadio::registerTxStatusReportListener](#).

##### Parameters

<i>in</i>	<i>info</i>	- Tx status of the transport block.
-----------	-------------	-------------------------------------

#### 4.27.1.37 class telux::cv2x::Cv2xUtil

Cv2x utility class

##### Static Public Member Functions

- static uint8\_t [priorityToTrafficClass](#) (Priority priority)
- static Priority [TrafficClassToPriority](#) (uint8\_t trafficClass)

#### 4.27.1.37.1 Member Function Documentation

##### 4.27.1.37.1.1 static uint8\_t telux::cv2x::Cv2xUtil::priorityToTrafficClass ( Priority *priority* ) [static]

This function is called to convert [cv2x](#) flow priority to traffic class. The Traffic Class indicates class or priority of IPv6 packet. If congestion occurs then packets with least priority will be discarded(See RFC2460 section-7). The result of this method is to fill the IPv6 header traffic class field, it is usually called just before sending IPv6 packet.

##### Parameters

<i>in</i>	<i>priority</i>	- <a href="#">cv2x</a> flow priority
-----------	-----------------	--------------------------------------

##### Returns

uint8\_t to indicate the result of traffic class

##### 4.27.1.37.1.2 static Priority telux::cv2x::Cv2xUtil::TrafficClassToPriority ( uint8\_t *trafficClass* ) [static]

This function is called to convert IPv6 packet traffic class to [cv2x](#) flow priority. The Traffic Class indicates class or priority of IPv6 packet. If congestion occurs then packets with least priority will be discarded(See RFC2460 section-7). It is to get the corresponding [cv2x](#) flow priority of the received packets, which usually being called when a new IPv6 packet received.

##### Parameters

<i>in</i>	<i>trafficClass</i>	- class or priority of IPv6 packet(See RFC2460 section-7)
-----------	---------------------	---

**Returns**

`cv2x` flow priority

**4.27.1.38 struct telux::cv2x::prop::Position**

**Position** in terms of latitude, longitude, and elevation along with its heading.

**Data fields**

Type	Field	Description
double	posLat	Latitude, in unit of degrees, range [-90.0, 90.0].
double	posLong	Longitude, in unit of degrees, range [-180.0, 180.0].
double	heading	Heading, in unit of degrees, range [0 to 359.999].
double	elev	Altitude above the WGS 84 reference ellipsoid, in unit of meters.

**4.27.1.39 struct telux::cv2x::prop::SubPERInterData**

sub per interval data (5 times per RV)

**Data fields**

Type	Field	Description
uint64_t	msgCntFirst	First message count of a vehicle in a PacketErrorRate sub interval
uint64_t	msgCntLast	Last message count of a vehicle in a PacketErrorRate sub interval
uint64_t	rxCnt	Total number of recieved messages of a vehicle in a PacketErrorRate sub interval
bool	isValid	Specifies if the remote vehicle's data is still valid for PER calculation

**4.27.1.40 struct telux::cv2x::prop::PERInterData**

per interval data (1 time per RV)

**Data fields**

Type	Field	Description
uint64_t	msgCntFirst	First message count of a vehicle in a PacketErrorRate interval
uint64_t	msgCntLast	Last message count of a vehicle in a PacketErrorRate interval
uint64_t	msgCntCurr	Current message count of a vehicle in a PacketErrorRate interval
uint64_t	totalExpect↔ Msgs	Total number of expected messages from a Remote Vehicle this PacketErrorRate interval
uint64_t	totalRxMsgs	Total actually received messages from a Remote Vehicle in a PacketErrorRate interval
uint64_t	totalMissMsgs	Total calculated missed messages from a Remote Vehicle in a PacketErrorRate interval
double	packetErrRate	Calculated Packet Error Rate for a Remote Vehicle based on totalExpectMsgs, totalRxMsgs, totalMissMsgs in this PacketErrorRate interval

Type	Field	Description
double	lastPacketErr↔ Rate	The most recent PacketErrorRate

#### 4.27.1.41 struct telux::cv2x::prop::CongestionControlData

data for each vehicle general information provided from the sender's message contents and also contains information updated while congestion control is running such as packet error rate (per) data

##### Data fields

Type	Field	Description
<a href="#">Position</a>	pos	Latest position of this vehicle
double	speed	Latest speed of this vehicle
uint64_t	rxTimeStamp	Latest received message time stamp of this vehicle
uint64_t	currMsgCnt	Latest msg cnt of this per interval (filled by the client)
vector< struct <a href="#">SubPERInter↔ Data</a> >	subPERInter↔ Data	Packet error rate data for this vehicle updated every PER sub interval
<a href="#">PERInterData</a>	packetErr↔ InterData	Packet error rate data for this vehicle updated every PER interval
bool	newPERSub↔ Interval	Flag indicating a new packet error rate (PER) sub interval is occurring
bool	inRange	Flag indicating this vehicle is in range within a specified threshold
uint64_t	lastTxMsgTime	Timestamp of last sent message
uint64_t	lastGnssFix↔ Time	Latest GNSS fix time
double	trackingErr	Latest calculated tracking error. The difference between the last assumed known position and the assumed estimated position.

#### 4.27.1.42 struct telux::cv2x::prop::ChannelData

channel quality related data

##### Data fields

Type	Field	Description
double	rawCbp	Unfiltered channel busy percentage
double	channBusy↔ Ratio	Filtered and calculated channel busy ratio
double	lastChann↔ BusyRatio	Last channel busy ratio
double	packetError↔ Rate	Latest interval's packet error rate
double	channQualInd	Latest channel quality indication value

**4.27.1.43 struct telux::cv2x::prop::SpsEnhanceData**

Output for sps enhancements

**Data fields**

Type	Field	Description
uint64_t	upperHyst↔ Thresh	Upper hysteresis-based SPS periodicity threshold
uint64_t	lowerHyst↔ Thresh	Lower hysteresis-based SPS periodicity threshold
uint64_t	roundedSps↔ Interval	SPS periodicity rounded to nearest valid periodicity
double	hysteresis	Percentage of hysteresis for threshold calculation

**4.27.1.44 struct telux::cv2x::prop::TrackingErrorData**

Data for tracking error calculation

**Data fields**

Type	Field	Description
<a href="#">Position</a>	lastPosSent	Last position sent out via message
double	lastSpeedSent	Last speed sent out via message
double	lastHeading↔ Sent	Last heading sent out via message
<a href="#">Position</a>	currPos	Current position
double	currSpeed	Current speed
double	currHeading	Current heading

**4.27.1.45 struct telux::cv2x::prop::CongestionControlCalculations**

Output of congestion control

**Data fields**

Type	Field	Description
bool	updateMaxITT	Alert the user to update their max ITT value if it needs to be
uint64_t	maxITT	Current max Inter-Transmit Time
bool	sendCritical↔ Msg	Alert the user to send a critical BSM via event flow
bool	sendNow	Alert the user to send at this moment
uint64_t	priority	New priority for the next packet sent OTA *
uint64_t	txPower	New transmit power
double	trackingError	Latest calculated tracking error
double	smoothDens	Latest calculated smoothed average density
int	totalRvsIn↔ Range	Latest unsmoothed density in range

Type	Field	Description
shared_ptr< <a href="#">ChannelData</a> >	channData	Latest calculated channel quality indicator and packet error rates
shared_ptr< <a href="#">SpsEnhanceData</a> >	spsEnhanceData	SPS flow changes that may need to be made for congestion control

#### 4.27.1.46 struct telux::cv2x::prop::CongestionControlUserData

User-provided struct for congestion control outputs Will contain the relevant information to let user know when to TX and also other settings/data that it should change/use for congestion control.

##### Data fields

Type	Field	Description
void *	spsTransmit	Pointer to be set to a TransmitFlow based class or data struct
bool	spsEnhancementsEnabled	Flag to let the manager know that sps enhancements are enabled
shared_ptr < <a href="#">CongestionControlCalculations</a> >	congestionControlCalculations	Output for the congestion control algorithm for user
sem_t *	congestionControlSem	Semaphore to prevent any race conditions when using output

#### 4.27.1.47 struct telux::cv2x::prop::SPSEnhanceConfig

Config for all SPS Enhancements

##### Data fields

Type	Field	Description
uint64_t	spsPeriodicity	The current SPS periodicity Supported values are 20, 50, and multiples of 100
uint64_t	changeFrequency	The chance for actually updating maximum inter-transmit time and also the SPS periodicity of the current SPS flow.
double	hysterPercent	A percentage which expands the range of hysteresis thresholds to prevent volatile changes in maximum inter-transmit time and SPS periodicity.

#### 4.27.1.48 struct telux::cv2x::prop::DensityConfig

Config for density calculation

**Data fields**

Type	Field	Description
double	densWeight↔ Factor	Density weight factor for lambda parameterized smoothing function
uint64_t	distThresh	Minimum distance threshold to consider a vehicle relevant for PER calculations.
double	densCoeff	Density coefficient constant which is part of maximum Inter-Transmit Time calculations. The smaller the value, the more sensitive the calculation.

**4.27.1.49 struct telux::cv2x::prop::PERConfig**

Config for packet error rate calculation

**Data fields**

Type	Field	Description
int	packetError↔ Interval	Time interval between each periodic packet error rate calculation
int	packetError↔ SubInterval	Each subinterval time period for packet error rate calculation
int	maxPER↔ Subinters	Numer of subintervals per Packet Error rATE interval. Equivalent to the interval time divided by subinterval time
double	maxPacket↔ ErrorRate	Maximum packet error rate threshold. Anything above is capped to this.

**4.27.1.50 struct telux::cv2x::prop::CQIConfig**

Config for channel quality calculation

**Data fields**

Type	Field	Description
uint64_t	threshold	Channel quality indication threshold

**4.27.1.51 struct telux::cv2x::prop::CBPConfig**

Config for channel busy percentage

**Data fields**

Type	Field	Description
double	cbpWeight↔ Factor	Weight factor in calculating the CBP from raw CBP
uint64_t	cbpInterval	Time interval between each periodic CBP calculation

#### 4.27.1.52 struct telux::cv2x::prop::TEConfig

Config for tracking error (TE).

##### Data fields

Type	Field	Description
uint64_t	txCtrlInterval	Interval for calculating the tracking error and determining new Inter-Transmit Time (ITT)
uint64_t	hvMinTimeDiff	Minimum HV position estimate delay used to calculate the HV local estimate
uint64_t	hvMaxTimeDiff	Maximum HV position estimate delay used to calculate the HV local estimate
uint64_t	rvMinTimeDiff	Minimum delay used to calculate the where RV estimates the HV to be
uint64_t	rvMaxTimeDiff	Maximum delay used to calculate the where RV estimates the HV to be
double	teLowerThresh	Minimum communications-based error threshold
double	teUpperThresh	Maximum tracking error upper threshold. Used to determine whether to send a BSM or not
uint64_t	errSensitivity	For calculating the probability of transmission based on tracking error

#### 4.27.1.53 struct telux::cv2x::prop::ITTConfig

Config for inter-transmit time

##### Data fields

Type	Field	Description
uint64_t	reschedThresh	Threshold for making decision to update ITT or not
uint64_t	timeAccuracy	Time resolution in time
uint64_t	minIttThresh	Minimum Inter-transmit time threshold
uint64_t	maxIttThresh	Maximum Inter-transmit time threshold
uint64_t	txRand	Random chance for not sending

#### 4.27.1.54 struct telux::cv2x::prop::PowerConfig

Config for power

##### Data fields

Type	Field	Description
uint64_t	minRadiPwr	Minimum permitted radiated power
uint64_t	maxRadiPwr	Maximum permitted radiated power

### 4.27.1.55 struct telux::cv2x::prop::CongestionControlConfig

Config for congestion control which contains sub-config items

#### Data fields

Type	Field	Description
<a href="#">PowerConfig</a>	pwrConfig	Power calculation Configuration parameters
<a href="#">CBPConfig</a>	cbpConfig	Channel Busy Percentage calculation Configuration parameters
<a href="#">CQIConfig</a>	cqiConfig	Channel Quality Indication calculation Configuration parameters
<a href="#">PERConfig</a>	perConfig	Packet Error Rate calculation Configuration parameters
<a href="#">DensityConfig</a>	densConfig	Smoothed In-Range Density calculation Configuration parameters
<a href="#">TEConfig</a>	teConfig	Tracking Error calculation Configuration parameters
<a href="#">ITTConfig</a>	ittConfig	Inter-Transmit Time calculation Configuration parameters
bool	enableSps↔ Enhance	Flag to enable SPS enhancements
<a href="#">SPSEnhance↔ Config</a>	spsEnhance↔ Config	SPS Enhancements Configuration parameters
<a href="#">Congestion↔ ControlType</a>	congestion↔ ControlType	Type of congestion control to be used. SAE only supported today

### 4.27.1.56 class telux::cv2x::prop::CongestionControlUtility

Utility class for congestion control logging and testing purposes.

#### Static Public Member Functions

- static void [setLoggingLevel](#) (uint8\_t loggingLevelIn)
- static uint8\_t [getLoggingLevel](#) ()
- static void [addDensity](#) (uint64\_t density, uint64\_t initDistance)

#### 4.27.1.56.1 Member Function Documentation

##### 4.27.1.56.1.1 static void telux::cv2x::prop::CongestionControlUtility::setLoggingLevel ( uint8\_t loggingLevelIn ) [static]

Sets the logging level

#### Parameters

in	<i>loggingLevel</i>	- value to indicate level of console logging
----	---------------------	--

#### Note

- Eval: This is a new API and is being evaluated. It is subject to change and could break backwards compatibility.



**4.27.1.56.1.2** `static uint8_t telux::cv2x::prop::CongestionControlUtility::getLoggingLevel ( )`  
`[static]`

Gets the logging level

**Note**

- Eval: This is a new API and is being evaluated. It is subject to change and could break backwards compatibility.

**Returns**

uin8\_t - the current logging level

**4.27.1.56.1.3** `static void telux::cv2x::prop::CongestionControlUtility::addDensity ( uint64_t density, uint64_t initDistance )` `[static]`

Adds an artificial density over time

**Parameters**

in	<i>density</i>	- artificial density that should be incorporated
in	<i>initDistance</i>	- the initial distance from host vehicle to artificial density

**Note**

- Eval: This is a new API and is being evaluated. It is subject to change and could break backwards compatibility.

**4.27.1.57 class telux::cv2x::prop::ICongestionControlListener**

Congestion Control listeners implement this interface.

**Public member functions**

- virtual void [onCongestionControlDataReady](#) (std::shared\_ptr< [CongestionControlUserData](#) > congestionControlUserData, bool critEvent)
- virtual [~ICongestionControlListener](#) ()

**4.27.1.57.1 Constructors and Destructors**

**4.27.1.57.1.1** `virtual telux::cv2x::prop::ICongestionControlListener::~~ICongestionControlListener ( )`  
`[virtual]`

Destructor for [ICongestionControlListener](#)

#### 4.27.1.57.2 Member Function Documentation

**4.27.1.57.2.1** virtual void telux::cv2x::prop::ICongestionControlListener::onCongestionControlDataReady ( std::shared\_ptr< CongestionControlUserData > *congestionControlUserData*, bool *critEvent* ) [virtual]

Called when the new congestion control data is available.

##### Parameters

in	<i>congestionControlUserData</i>	- pointer to output user data which manager will fill. Lets the user know they should immediately send a new message. If SPS enhancements are enabled, they may also need to perform SPS periodicity change.
in	<i>critEvent</i>	- tells the listener that there is a critical event

##### Note

- Eval: This is a new API and is being evaluated. It is subject to change and could break backwards compatibility.

#### 4.27.1.58 class telux::cv2x::prop::ICongestionControlManager

CongestionControl Manager is a primary interface for CongestionControl related functionality.

##### Public member functions

- virtual [CCErrorCode](#) updateCongestionControlConfig (std::shared\_ptr< [CongestionControlConfig](#) > congestionControlConfigIn)=0
- virtual [CCErrorCode](#) updateCongestionControlType ([CongestionControlType](#) congestionControlType)=0
- virtual [CCErrorCode](#) startCongestionControl ()=0
- virtual [CCErrorCode](#) stopCongestionControl ()=0
- virtual [CCErrorCode](#) registerListener (std::weak\_ptr< [ICongestionControlListener](#) > congCtrlListener)=0
- virtual [CCErrorCode](#) deregisterListener (std::weak\_ptr< [ICongestionControlListener](#) > congCtrlListener)=0
- virtual std::shared\_ptr< [CongestionControlUserData](#) > getCongestionControlUserData ()=0
- virtual [CCErrorCode](#) updateCbpConfig (double cbpWeightFactor, uint64\_t cbpInterval)=0
- virtual [CCErrorCode](#) updatePERConfig (double maxPacketErrorRate, int packetErrorRateInterval, int packetErrorRateSubInterval)=0
- virtual [CCErrorCode](#) updateDensConfig (double densCoeff, double densWeightFactor, uint64\_t distThresh)=0
- virtual [CCErrorCode](#) updateTeConfig (uint64\_t txCtrlInterval, uint64\_t hvMinTimeDiff, uint64\_t hvMaxTimeDiff, uint64\_t rvMinTimeDiff, uint64\_t rvMaxTimeDiff, uint64\_t teLowerThresh,

- uint64\_t teUpperThresh, uint64\_t errSensitivity)=0
- virtual [CCErrorCode updateIttConfig](#) (uint64\_t reschedThresh, uint64\_t timeAccuracy, uint64\_t minIttThresh, uint64\_t maxIttThresh, uint64\_t txRand)=0
- virtual [CCErrorCode updateTxRateCtrlInterval](#) (uint64\_t txCtrlInterval)=0
- virtual [CCErrorCode updateSpsEnhanceConfig](#) (uint64\_t spsPeriodicity, uint64\_t changeFrequency, double hysterPercent)=0
- virtual void [enableSpsEnhancements](#) (bool enable)=0
- virtual bool [isSpsEnhanceEnabled](#) ()=0
- virtual [CCErrorCode updateHostVehicleData](#) ([Position](#) &pos, double speed)=0
- virtual [CCErrorCode updateLastTxTime](#) (uint64\_t lastTxTime)=0
- virtual [CCErrorCode updateHvGnssFixTime](#) (uint64\_t gnssFixTimestamp)=0
- virtual [CCErrorCode updateChannelBusyRate](#) (double channBusyRatio)=0
- virtual [CCErrorCode notifyCriticalEvent](#) ()=0
- virtual [CCErrorCode disableCriticalEvent](#) ()=0
- virtual [CCErrorCode addCongestionControlData](#) (uint64\_t id, double latitude, double longitude, double heading, double speed, uint64\_t timestamp, uint64\_t msgCount)=0
- virtual [CCErrorCode removeCongestionControlData](#) (uint64\_t id)=0
- virtual std::shared\_ptr< [CongestionControlData](#) > [getCongestionControlData](#) (uint64\_t id)=0
- [ICongestionControlManager](#) ()
- [~ICongestionControlManager](#) ()

#### 4.27.1.58.1 Constructors and Destructors

4.27.1.58.1.1 `telux::cv2x::prop::ICongestionControlManager::ICongestionControlManager ( )`

4.27.1.58.1.2 `telux::cv2x::prop::ICongestionControlManager::~~ICongestionControlManager ( )`

#### 4.27.1.58.2 Member Function Documentation

4.27.1.58.2.1 `virtual CCErrorCode telux::cv2x::prop::ICongestionControlManager::updateCongestionControlConfig ( std::shared_ptr< CongestionControlConfig > congestionControlConfigIn ) [pure virtual]`

Called to update the internal config parameters with custom values

#### Parameters

in	<i>congestionControlConfigIn</i>	- a struct that holds various smaller config structs for each component of congestion control
----	----------------------------------	---

**Note**

- Eval: This is a new API and is being evaluated. It is subject to change and could break backwards compatibility.

**Returns**

CCErrorCode code meaning success or reason for error, if any

**4.27.1.58.2.2** `virtual CCErrorCode telux::cv2x::prop::ICongestionControlManager::update↔  
CongestionControlType ( CongestionControlType congestionControlType ) [pure  
virtual]`

Called to update the type of congestion control

**Parameters**

in	<i>congestionControl↔ Type</i>	- type of congestion control to be performed
----	------------------------------------	--

**Note**

- Eval: This is a new API and is being evaluated. It is subject to change and could break backwards compatibility.

**Returns**

CCErrorCode code meaning success or reason for error, if any

**4.27.1.58.2.3** `virtual CCErrorCode telux::cv2x::prop::ICongestionControlManager::startCongestion↔  
Control ( ) [pure virtual]`

The primary congestion control driver to be called after initialization. Launches various threads for different components of congestion control. Including channel quality, packet error rate, density, and inter-transmit time calculations.

**Note**

- Eval: This is a new API and is being evaluated. It is subject to change and could break backwards compatibility.

**Returns**

CCErrorCode code meaning success or reason for error, if any

**4.27.1.58.2.4** `virtual CCErrorCode telux::cv2x::prop::ICongestionControlManager::stopCongestion↔  
Control ( ) [pure virtual]`

Gracefully closes any lingering threads, semaphores, and cleans up any allocated data.

**Note**

- Eval: This is a new API and is being evaluated. It is subject to change and could break backwards compatibility.

**Returns**

CCErrorCode code meaning success or reason for error, if any

**4.27.1.58.2.5** `virtual CCErrorCode telux::cv2x::prop::ICongestionControlManager::registerListener ( std::weak_ptr< ICongestionControlListener > congCtrlListener ) [pure virtual]`

Called to register a [ICongestionControlListener](#), which will be notified when new congestion control data is ready.

**Parameters**

in	<i>congCtrlListener</i>	- user-implemented class to listen for output user data which manager will fill. Lets the user know they should immediately send a new message. If SPS enhancements are enabled, they may perform SPS periodicity change.
----	-------------------------	---

**Note**

- Eval: This is a new API and is being evaluated. It is subject to change and could break backwards compatibility.

**Returns**

CCErrorCode code meaning success or reason for error, if any

**4.27.1.58.2.6** `virtual CCErrorCode telux::cv2x::prop::ICongestionControlManager::deregisterListener ( std::weak_ptr< ICongestionControlListener > congCtrlListener ) [pure virtual]`

Called to deregister a [ICongestionControlListener](#) implementation

**Parameters**

in	<i>congCtrlListener</i>	- user-implemented class to be deregistered
----	-------------------------	---

**Note**

- Eval: This is a new API and is being evaluated. It is subject to change and could break backwards compatibility.

**Returns**

CCErrorCode code meaning success or reason for error, if any

**4.27.1.58.2.7** `virtual std::shared_ptr<CongestionControlUserData> telux::cv2x::prop::lCongestionControlManager::getCongestionControlUserData ( ) [pure virtual]`

Called to get a shared pointer to the results of the Congestion Control periodic calculations.

#### Note

- Eval: This is a new API and is being evaluated. It is subject to change and could break backwards compatibility.

#### Returns

`std::shared_ptr<CongestionControlUserData>` - shared pointer reference to the [CongestionControlUserData](#) that the manager will update.

**4.27.1.58.2.8** `virtual CCErrCode telux::cv2x::prop::lCongestionControlManager::updateCbpConfig ( double cbpWeightFactor, uint64_t cbpInterval ) [pure virtual]`

Update the channel busy percentage related configs

#### Parameters

in	<i>cbpWeightFactor</i>	- weight factor for channel busy percentage calculation
in	<i>cbpInterval</i>	- interval for channel busy percentage calculation

#### Note

- Eval: This is a new API and is being evaluated. It is subject to change and could break backwards compatibility.

#### Returns

CCErrCode code meaning success or reason for error, if any

**4.27.1.58.2.9** `virtual CCErrCode telux::cv2x::prop::lCongestionControlManager::updatePERConfig ( double maxPacketErrorRate, int packetErrorRateInterval, int packetErrorRateSubInterval ) [pure virtual]`

Update the packet error rate related configs

#### Parameters

in	<i>maxPacketErrorRate</i>	- maximum packet error rate
in	<i>packetErrorRateInterval</i>	- overall interval time for packet error calculation
in	<i>packetErrorRateSubInterval</i>	- sub interval time for packet error rate calculation

**Note**

- Eval: This is a new API and is being evaluated. It is subject to change and could break backwards compatibility.

**Returns**

CCErrorCode code meaning success or reason for error, if any

**4.27.1.58.2.10** virtual CCErrorCode telux::cv2x::prop::ICongestionControlManager::updateDensConfig ( double *densCoeff*, double *densWeightFactor*, uint64\_t *distThresh* ) [pure virtual]

Update the density related configs

**Parameters**

in	<i>densCoeff</i>	- density coefficient for evaluating maximum inter-transmit time
in	<i>densWeightFactor</i>	- weight factor coefficient for smoothed density
in	<i>distThresh</i>	- threshold for minimal distance between host and remote vehicles

**Note**

- Eval: This is a new API and is being evaluated. It is subject to change and could break backwards compatibility.

**Returns**

CCErrorCode code meaning success or reason for error, if any

**4.27.1.58.2.11** virtual CCErrorCode telux::cv2x::prop::ICongestionControlManager::updateTeConfig ( uint64\_t *txCtrlInterval*, uint64\_t *hvMinTimeDiff*, uint64\_t *hvMaxTimeDiff*, uint64\_t *rv↔MinTimeDiff*, uint64\_t *rvMaxTimeDiff*, uint64\_t *teLowerThresh*, uint64\_t *teUpperThresh*, uint64\_t *errSensitivity* ) [pure virtual]

Update the tracking error related configs

**Parameters**

in	<i>txCtrlInterval</i>	- interval for transmit rate control
in	<i>hvMinTimeDiff</i>	- min time difference between hv last known position and current
in	<i>hvMaxTimeDiff</i>	- max time difference between hv last known position and current
in	<i>rvMinTimeDiff</i>	- min time difference between rv last known position and current
in	<i>rvMaxTimeDiff</i>	- max time difference between rv last known position and current
in	<i>teLowerThresh</i>	- tracking error lower threshold

in	<i>teUpperThresh</i>	- tracking error upper threshold
in	<i>errSensitivity</i>	- tracking error sensitivity

**Note**

- Eval: This is a new API and is being evaluated. It is subject to change and could break backwards compatibility.

**Returns**

CCErrorCode code meaning success or reason for error, if any

**4.27.1.58.2.12** `virtual CCErrorCode telux::cv2x::prop::ICongestionControlManager::updateIttConfig ( uint64_t reschedThresh, uint64_t timeAccuracy, uint64_t minIttThresh, uint64_t maxIttThresh, uint64_t txRand ) [pure virtual]`

Update the inter-transmit time related configs

**Parameters**

in	<i>reschedThresh</i>	- threshold for rescheduling frequency
in	<i>timeAccuracy</i>	- accuracy of time
in	<i>minIttThresh</i>	- minimum inter-transmit time
in	<i>maxIttThresh</i>	- maximum inter-transmit time
in	<i>txRand</i>	- transmission chance randomness

**Note**

- Eval: This is a new API and is being evaluated. It is subject to change and could break backwards compatibility.

**Returns**

CCErrorCode code meaning success or reason for error, if any

**4.27.1.58.2.13** `virtual CCErrorCode telux::cv2x::prop::ICongestionControlManager::updateTxRateCtrlInterval ( uint64_t txCtrlInterval ) [pure virtual]`

Update the transmit rate control related configs

**Parameters**

in	<i>txCtrlInterval</i>	- time interval for periodic calculations of tracking error and inter-transmit time.
----	-----------------------	--

**Note**

- Eval: This is a new API and is being evaluated. It is subject to change and could break backwards compatibility.



**Returns**

CCErrorCode code meaning success or reason for error, if any

**4.27.1.58.2.14** `virtual CCErrorCode telux::cv2x::prop::ICongestionControlManager::updateSps↔  
EnhanceConfig ( uint64_t spsPeriodicity, uint64_t changeFrequency, double  
hysterPercent ) [pure virtual]`

Update the sps enhancements related config

**Parameters**

in	<i>spsPeriodicity</i>	- New periodicity of sps flow to be set by user
in	<i>changeFrequency</i>	- Random chance to not change sps flow periodicity and inter-transmit time
in	<i>hysterPercent</i>	- Hysteresis percentage for choosing the inter-transmit time thresholds. Used to prevent frequent changes to sps flow periodicity.

**Note**

- Eval: This is a new API and is being evaluated. It is subject to change and could break backwards compatibility.

**Returns**

CCErrorCode code meaning success or reason for error, if any

**4.27.1.58.2.15** `virtual void telux::cv2x::prop::ICongestionControlManager::enableSpsEnhancements (   
bool enable ) [pure virtual]`

Enables sps enhancements

**Parameters**

in	<i>enable</i>	- Boolean to enable or disable sps enhancements
----	---------------	---

**Note**

- Eval: This is a new API and is being evaluated. It is subject to change and could break backwards compatibility.

**4.27.1.58.2.16** `virtual bool telux::cv2x::prop::ICongestionControlManager::isSpsEnhanceEnabled ( )   
[pure virtual]`

Used to check if sps enhancements are enabled

**Note**

- Eval: This is a new API and is being evaluated. It is subject to change and could break backwards compatibility.

**Returns**

CCErrorCode code meaning success or reason for error, if any

**4.27.1.58.2.17** `virtual CCErrorCode telux::cv2x::prop::ICongestionControlManager::updateHostVehicleData ( Position & pos, double speed ) [pure virtual]`

Used whenever the user needs to update latest host vehicle information to manager

**Parameters**

in	<i>pos</i>	- latest position (lat, long, elevation) of host vehicle
in	<i>speed</i>	- latest speed of host vehicle

**Note**

- Eval: This is a new API and is being evaluated. It is subject to change and could break backwards compatibility.

**Returns**

CCErrorCode code meaning success or reason for error, if any

**4.27.1.58.2.18** `virtual CCErrorCode telux::cv2x::prop::ICongestionControlManager::updateLastTxTime ( uint64_t lastTxTime ) [pure virtual]`

Used whenever the user needs to update latest host vehicle information to manager

**Parameters**

in	<i>lastTxTime</i>	- latest tx time of host vehicle (if any) used for scheduling
----	-------------------	---

**Note**

- Eval: This is a new API and is being evaluated. It is subject to change and could break backwards compatibility.

**Returns**

CCErrorCode code meaning success or reason for error, if any

**4.27.1.58.2.19** `virtual CCErrorCode telux::cv2x::prop::ICongestionControlManager::updateHvGnssFixTime ( uint64_t gnssFixTimestamp ) [pure virtual]`

Update the host vehicle gnss fix time

**Parameters**

in	<i>gnssFixTimestamp</i>	- the new host vehicle gnss fix timestamp
----	-------------------------	---

**Note**

- Eval: This is a new API and is being evaluated. It is subject to change and could break backwards compatibility.

**Returns**

CCErrorCode code meaning success or reason for error, if any

**4.27.1.58.2.20** `virtual CCErrorCode telux::cv2x::prop::ICongestionControlManager::updateChannel(↔  
BusyRate ( double channBusyRatio ) [pure virtual]`

Update the channel busy ratio

**Parameters**

in	<i>channBusyRatio</i>	- current channel busy ratio of host vehicle
----	-----------------------	--

**Note**

- Eval: This is a new API and is being evaluated. It is subject to change and could break backwards compatibility.

**Returns**

CCErrorCode code meaning success or reason for error, if any

**4.27.1.58.2.21** `virtual CCErrorCode telux::cv2x::prop::ICongestionControlManager::notifyCriticalEvent ( ) [pure virtual]`

Should be called when user detects a critical event. This function notifies the congestion control manager about the critical event. This is important so that the manager can update the internal transmit schedule for a specified time.

**Note**

- Eval: This is a new API and is being evaluated. It is subject to change and could break backwards compatibility.

**Returns**

CCErrorCode code meaning success or reason for error, if any

**4.27.1.58.2.22** `virtual CCErrorCode telux::cv2x::prop::ICongestionControlManager::disableCriticalEvent ( ) [pure virtual]`

Called when user needs to notify congestion control to disable critical event

**Note**

- Eval: This is a new API and is being evaluated. It is subject to change and could break backwards compatibility.

**Returns**

CCErrorCode code meaning success or reason for error, if any

**4.27.1.58.2.23** virtual CCErrorCode telux::cv2x::prop::ICongestionControlManager::addCongestionControlData ( uint64\_t *id*, double *latitude*, double *longitude*, double *heading*, double *speed*, uint64\_t *timestamp*, uint64\_t *msgCount* ) [pure virtual]

Called whenever there is a packet received from new vehicle nearby

**Parameters**

in	<i>id</i>	- A remote vehicle identity
in	-	latitude - latitude of the vehicle
in	-	longitude - longitude of the vehicle
in	-	heading - heading of the vehicle
in	-	speed - speed of the vehicle
in	-	timestamp - timestamp at which the message was received
in	-	msgCount - Current message count taken from the decoded message

**Note**

- Eval: This is a new API and is being evaluated. It is subject to change and could break backwards compatibility.

**Returns**

CCErrorCode code meaning success or reason for error, if any

**4.27.1.58.2.24** virtual CCErrorCode telux::cv2x::prop::ICongestionControlManager::removeCongestionControlData ( uint64\_t *id* ) [pure virtual]

Called when we need to remove data related to a vehicle

**Parameters**

in	<i>id</i>	- A remote vehicle identity whose <a href="#">CongestionControlData</a> will be removed from the manager. This API is called when a remote vehicle has left a specified range or is no longer important for congestion control.
----	-----------	---

**Note**

- Eval: This is a new API and is being evaluated. It is subject to change and could break backwards compatibility.

**Returns**

CCErrorCode code meaning success or reason for error, if any

#### 4.27.1.58.2.25 virtual std::shared\_ptr<CongestionControlData> telux::cv2x::prop::ICongestionControlManager::getCongestionControlData ( uint64\_t id ) [pure virtual]

Called when user needs to access a nearby vehicle's latest congestion control data

##### Parameters

in	<i>id</i>	- A remote vehicle identity
----	-----------	-----------------------------

##### Note

- Eval: This is a new API and is being evaluated. It is subject to change and could break backwards compatibility.

##### Returns

[CongestionControlData](#) copy of the data the manager has and uses for a given vehicle id, if any.

#### 4.27.1.59 class telux::cv2x::prop::CongestionControlUtil

##### Public member functions

- uint64\_t [timestamp\\_now](#) (void)
- uint64\_t [timestamp\\_now\\_ms](#) (void)
- uint64\_t [timestamp\\_now\\_ns](#) (void)

##### 4.27.1.59.1 Member Function Documentation

###### 4.27.1.59.1.1 uint64\_t telux::cv2x::prop::CongestionControlUtil::timestamp\_now ( void )

Return current time stamp in seconds

##### Returns

long long

###### 4.27.1.59.1.2 uint64\_t telux::cv2x::prop::CongestionControlUtil::timestamp\_now\_ms ( void )

Return current time stamp in milliseconds

##### Returns

long long

**4.27.1.59.1.3 uint64\_t telux::cv2x::prop::CongestionControlUtil::timestamp\_now\_ns ( void )**

Return current time stamp in nanoseconds

**Returns**

long long

**4.27.1.60 class telux::cv2x::prop::V2xPropFactory**

[V2xPropFactory](#) allows creation of [ICongestionControlManager](#).

**Public member functions**

- virtual std::shared\_ptr< [ICongestionControlManager](#) > [getCongestionControlManager](#) ()=0

**Static Public Member Functions**

- static [V2xPropFactory](#) & [getInstance](#) ()

**4.27.1.60.1 Member Function Documentation****4.27.1.60.1.1 static V2xPropFactory& telux::cv2x::prop::V2xPropFactory::getInstance ( ) [static]**

Gets the [V2xPropFactory](#) instance. On platforms with access control enabled, the caller needs to have TELUX\_CV2X\_CONGESTION\_CONTROL permission to successfully invoke this API.

**4.27.1.60.1.2 virtual std::shared\_ptr<ICongestionControlManager> telux::cv2x::prop::V2xPropFactory::getCongestionControlManager ( ) [pure virtual]**

Provides a [CongestionControlManager](#) instance to be used to perform v2x congestion control. On platforms with access control enabled, the caller needs to have TELUX\_CV2X\_CONGESTION\_CONTROL permission to successfully invoke this API.

**Returns**

[ICongestionControlManager](#) instance

**4.27.2 Enumeration Type Documentation****4.27.2.1 enum telux::cv2x::TrafficCategory [strong]**

Defines CV2X Traffic Types.

**Enumerator**

- SAFETY\_TYPE** Safety message traffic category
- NON\_SAFETY\_TYPE** Non-safety message traffic category

### 4.27.2.2 enum telux::cv2x::Cv2xStatusType [strong]

Defines possible values for CV2X radio RX/TX status.

1. If Rx is in inactive state, Tx should also be in inactive state.
2. If Rx is in active state, Tx should be in active(normal case) or suspended state(sensing or tunnel mode).
3. If Rx is in suspended state, Tx should be in suspended state. Used in [Cv2xStatus](#)

#### Enumerator

**INACTIVE** RX/TX is inactive  
**ACTIVE** RX/TX is active  
**SUSPENDED** RX/TX is suspended  
**UNKNOWN** RX/TX status unknown

### 4.27.2.3 enum telux::cv2x::Cv2xCauseType [strong]

Defines possible values for cause of CV2X radio failure. The cause code is only associated with [cv2x](#) suspend/inactive status, if [cv2x](#) is active, the cause code has no meaning. Used in [Cv2xStatus](#)

#### Enumerator

**TIMING** CV2X is suspended due to the outage of timing reference.  
**CONFIG** CV2X is inactive due to v2x.xml is missing, invalid, or expired.  
**UE\_MODE** CV2X is inactive due to CV2X mode is not started.  
**GEOPOLYGON** CV2X is inactive due to UE enters a geo-polygon that does not support [cv2x](#).  
**THERMAL** CV2X is suspended when the device's temperature is high.  
**THERMAL\_ECALL** CV2X is suspended when the device's temperature is high and emergency call is ongoing.  
**GEOPOLYGON\_SWITCH** CV2X is suspended when UE switches to a new geopolygon that also supports CV2X and UE is already in CV2X active status, CV2X status will change to active after the update is done.  
**SENSING** CV2X Tx is suspended when GNSS signal recovers or CV2X mode just starts. UE needs sensing for 1 second before Tx can begin, Tx status will change to active after sensing is done.  
**LPM** CV2X is inactive when UE enters Low Power Mode.  
**DISABLED** CV2X is inactive due to CV2X is disabled in the EFS.  
**NO\_GNSS** CV2X is inactive due to GNSS signal is not available when starting CV2X.  
**INVALID\_LICENSE** CV2X is inactive due to invalid license.  
**UNKNOWN** Invalid cause type only used internally.

### 4.27.2.4 enum telux::cv2x::SlssSyncPattern [strong]

Defines possible values for SLSS sync pattern. Used in [SyncRefUeInfo](#)

**Enumerator**

**OFFSET\_IND\_1** UE transmits SLSS in subframes indicated by the syncOffsetIndicator1 specified in V2X configuration.

**OFFSET\_IND\_2** UE transmits SLSS in subframes indicated by the syncOffsetIndicator2 specified in V2X configuration.

**OFFSET\_IND\_3** UE transmits SLSS in subframes indicated by the syncOffsetIndicator3 specified in V2X configuration.

**ODD\_RESERVED** UE transmits SLSS in odd-numbered reserved subframes.

**EVEN\_RESERVED** UE transmits SLSS in even-numbered reserved subframes.

**UNKNOWN** Invalid cause type only used internally.

**4.27.2.5 enum telux::cv2x::TrafficIpType [strong]**

Defines CV2X traffic type in terms of IP or NON-IP.

**Enumerator**

**TRAFFIC\_IP** IP message traffic

**TRAFFIC\_NON\_IP** NON-IP message traffic

**4.27.2.6 enum telux::cv2x::RadioConcurrencyMode [strong]**

Defines CV2X modes of concurrency with cellular WWAN.

Used in [Cv2xRadioCapabilities](#)

**Enumerator**

**WWAN\_NONCONCURRENT** No simultaneous WWAN + CV2X on this interface

**WWAN\_CONCURRENT** Interface supports requests for concurrent WWAN + CV2X connections.

**4.27.2.7 enum telux::cv2x::Cv2xEvent [strong]**

Defines CV2X status change events. The state can change in response to the loss of timing precision or a geofencing change.

Used in [ICv2xRadioListener::onStatusChanged](#)

**Enumerator**

**CV2X\_INACTIVE**

**CV2X\_ACTIVE**

**TX\_SUSPENDED**

**TXRX\_SUSPENDED**

**4.27.2.8 enum telux::cv2x::Priority [strong]**

Range of supported priority levels, where a lower number means a higher priority. For example, 8 is the current 3GPP standard.

Used in [Cv2xRadioCapabilities](#) and [SpsFlowInfo](#)



**Enumerator**

***MOST\_URGENT***  
***PRIORITY\_1***  
***PRIORITY\_2***  
***PRIORITY\_3***  
***PRIORITY\_4***  
***PRIORITY\_5***  
***PRIORITY\_6***  
***PRIORITY\_BACKGROUND***  
***PRIORITY\_UNKNOWN***

**4.27.2.9 enum telux::cv2x::Periodicity [strong]**

Range of supported periodicities in milliseconds.

Used in [Cv2xRadioCapabilities](#) and [SpsFlowInfo](#)

**Deprecated**

: enum class not going to be supported in future releases. Clients should stop using this. Once a class has been marked as Deprecated, the class could be removed in future releases.

**Enumerator**

***PERIODICITY\_10MS***  
***PERIODICITY\_20MS***  
***PERIODICITY\_50MS***  
***PERIODICITY\_100MS***  
***PERIODICITY\_UNKNOWN***

**4.27.2.10 enum telux::cv2x::ConfigSourceType [strong]**

V2X configuration source types listed in ascending order of priority. The system always uses the V2X configuration with the highest priority if multiple V2X configuration sources exist.

Used in [ConfigEventInfo](#)

**Enumerator**

***UNKNOWN*** V2X config file source is unknown  
***PRECONFIG*** V2X config file source is preconfig  
***SIM\_CARD*** V2X config file source is SIM card  
***OMA\_DM*** V2X config file source is OMA-DM

**4.27.2.11 enum telux::cv2x::ConfigEvent [strong]**

Defines possible values for the events relevant to CV2X config file.

Used in [ConfigEventInfo](#)

**Enumerator****CHANGED** V2X config file is changed**EXPIRED** V2X config file is expired**4.27.2.12 enum telux::cv2x::RFTxStatus [strong]**

Fault detection for Tx chain that including PA and front end.

Used in [RFTxInfo](#)**Enumerator****INACTIVE** The Tx chain is not working.**OPERATIONAL** The Tx chain is operational.**FAULT** Fault detected on the Tx chain.**4.27.2.13 enum telux::cv2x::SegmentType [strong]**

Defines possible values for the segment type of a transport block.

Used in [TxStatusReport](#)**Enumerator****FIRST** V2X packet is segmented, it's the first transport block.**LAST** V2X packet is segmented, it's the last transport block.**MIDDLE** V2X packet is segmented, it's a transport block between first and last.**ONLY\_ONE** V2X packet is not segmented, it's the only one transport block.**4.27.2.14 enum telux::cv2x::TxType [strong]**

Defines new Tx or re-Tx type relevant to a transport block.

Used in [TxStatusReport](#)**Enumerator****NEW\_TX** New Tx of the V2X transport block.**RE\_TX** Re-Tx of the V2X transport block.**SLSS\_TX** Tx of SLSS.**4.27.2.15 enum telux::cv2x::RxMetaDataValidityType**Specify set of RX Meta data that contribute to received packet's meta data report. Used in [RxPacketMetaDataReport](#)**Enumerator****RX\_SUBFRAME\_NUMBER** Bit mask to specify whether sfn is valid in [RxPacketMetaDataReport](#) Bit mask to specify whether subChannelIndex is valid in [RxPacketMetaDataReport](#)**RX\_SUBCHANNEL\_INDEX** Bit mask to specify whether subChannelNum is valid in [RxPacketMetaDataReport](#)**RX\_SUBCHANNEL\_NUMBER** Bit mask to specify whether rssi0 is valid in [RxPacketMetaDataReport](#)

**RX\_PRX\_RSSI** Bit mask to specify whether rssi1 is valid in [RxPacketMetaDataReport](#)  
**RX\_DRX\_RSSI** Bit mask to specify whether l2DestinationId is valid in [RxPacketMetaDataReport](#)  
**RX\_L2\_DEST\_ID** Bit mask to specify whether sciFormat1Info is valid in [RxPacketMetaDataReport](#)  
**RX\_SCI\_FORMAT1** Bit mask to specify whether delayEstimation is valid in [RxPacketMetaDataReport](#)  
**RX\_DELAY\_ESTIMATION**

#### 4.27.2.16 enum telux::cv2x::prop::CCErrorCode [strong]

##### Enumerator

**SUCCESS** No error  
**GENERIC\_FAILURE** Generic Failure  
**NO\_PERMISSION** No permission

#### 4.27.2.17 enum telux::cv2x::prop::CongestionControlType [strong]

Type of congestion control

##### Enumerator

**SAE** Default type of congestion control. Based on J3161/1 and J2945/1.

### 4.27.3 Function Documentation

#### 4.27.3.1 void telux::cv2x::prop::printPosition ( Position & position )

Print [Position](#) items

##### Parameters

in	<i>position</i>	- position struct reference
----	-----------------	-----------------------------

#### 4.27.3.2 void telux::cv2x::prop::printChannelData ( ChannelData & channelData )

Print [ChannelData](#) items

##### Parameters

in	<i>channelData</i>	- channel data struct reference
----	--------------------	---------------------------------

#### 4.27.3.3 void telux::cv2x::prop::printTrackingErrorData ( TrackingErrorData & teData )

Print [TrackingErrorData](#) items

##### Parameters

in	<i>teData</i>	- tracking error input struct reference
----	---------------	---

#### 4.27.3.4 void telux::cv2x::prop::printSPSEnhanceConfig ( SPSEnhanceConfig & *spsEnhanceConfig* )

Print [SPSEnhanceConfig](#) items

##### Parameters

in	<i>spsEnhanceConfig</i>	- sps enhancements config struct reference
----	-------------------------	--

#### 4.27.3.5 void telux::cv2x::prop::printDensityConfig ( DensityConfig & *densConfig* )

Print [DensityConfig](#) items

##### Parameters

in	<i>densConfig</i>	- density config struct reference
----	-------------------	-----------------------------------

#### 4.27.3.6 void telux::cv2x::prop::printPERConfig ( PERConfig & *perConfig* )

Print [PERConfig](#) items

##### Parameters

in	<i>perConfig</i>	- packet error rate config struct reference
----	------------------	---

#### 4.27.3.7 void telux::cv2x::prop::printCQIConfig ( CQIConfig & *cqiConfig* )

Print [CQIConfig](#)

##### Parameters

in	<i>cqiConfig</i>	- channel quality indication config struct reference
----	------------------	--

#### 4.27.3.8 void telux::cv2x::prop::printCBPConfig ( CBPConfig & *cbpConfig* )

Print [CBPConfig](#) items

##### Parameters

in	<i>cbpConfig</i>	- channel busy percentage config struct reference
----	------------------	---

#### 4.27.3.9 void telux::cv2x::prop::printTEConfig ( TEConfig & *teConfig* )

Print [TEConfig](#) items

**Parameters**

in	<i>teConfig</i>	- tracking error config struct reference
----	-----------------	--

**4.27.3.10 void telux::cv2x::prop::printITTConfig ( ITTConfig & *ittConfig* )**

Print [ITTConfig](#) items

**Parameters**

in	<i>ittConfig</i>	- inter transmit time config struct reference
----	------------------	---

**4.27.3.11 void telux::cv2x::prop::printPowerConfig ( PowerConfig & *powerConfig* )**

Print [PowerConfig](#) items

**Parameters**

in	<i>powerConfig</i>	- power config struct reference
----	--------------------	---------------------------------

**4.27.4 Variable Documentation****4.27.4.1 constexpr uint8\_t telux::cv2x::MAX\_ANTENNAS\_SUPPORTED = 2u**

Defines Maximum number of antennas that is supported.

Used in [TxStatusReport](#)

## 4.28 Audio

- [Audio Manager](#)
- [Audio Streams](#)
- [Transcoder](#)

This section contains APIs related to audio.

### 4.28.1 Data Structure Documentation

#### 4.28.1.1 class telux::audio::AudioFactory

Allows the creation of an [IAudioManager](#) instance.

##### Public member functions

- virtual `std::shared_ptr< IAudioManager > getAudioManager (telux::common::InitResponseCb callback=nullptr)=0`

##### Static Public Member Functions

- static `AudioFactory & getInstance ()`

#### 4.28.1.1.1 Member Function Documentation

##### 4.28.1.1.1.1 static `AudioFactory& telux::audio::AudioFactory::getInstance ( ) [static]`

Gets the [AudioFactory](#) instance.

##### 4.28.1.1.1.2 virtual `std::shared_ptr<IAudioManager> telux::audio::AudioFactory::getAudioManager (telux::common::InitResponseCb callback = nullptr ) [pure virtual]`

Gets the [IAudioManager](#) instance.

##### Parameters

in	<i>callback</i>	Optional, callback to know the status of the AudioManager initialization
----	-----------------	--

##### Returns

[IAudioManager](#) instance

## 4.29 Audio Manager

This section contains APIs related to Audio Manager operation.

### 4.29.1 Data Structure Documentation

#### 4.29.1.1 struct telux::audio::FormatParams

Represents the base class for compressed audio formats.

#### 4.29.1.2 struct telux::audio::AmrwbpParams

Specifies the details of the adaptive multirate wide band format frame.

##### Data Fields

- [uint32\\_t bitWidth](#)
- [AmrwbpFrameFormat frameFormat](#)

##### 4.29.1.2.1 Field Documentation

###### 4.29.1.2.1.1 uint32\_t telux::audio::AmrwbpParams::bitWidth

Bit width of the stream (16 or 24)

###### 4.29.1.2.1.2 AmrwbpFrameFormat telux::audio::AmrwbpParams::frameFormat

Refer to [AmrwbpFrameFormat](#)

#### 4.29.1.3 struct telux::audio::StreamConfig

Defines the parameters when creating an audio stream. The required parameters for a given use-case are as follows:

For regular voicecall: type, slotId, channelTypeMask, format, deviceTypes For hpcm-voicecall: type, slotId, channelTypeMask, format, deviceTypes, enableHpcm For ecall: type, slotId, channelTypeMask, format, deviceTypes, ecnrMode

For playback: type, sampleRate, channelTypeMask, format, deviceTypes For incall-playback and hpcm-playback: type, sampleRate, channelTypeMask, format, deviceTypes, voicePaths

For capture: type, sampleRate, channelTypeMask, format, deviceTypes For incall-capture and hpcm-capture: type, sampleRate, channelTypeMask, format, deviceTypes, voicePaths

For loopback: type, sampleRate, channelTypeMask, format, deviceTypes

For tone-generation: type, sampleRate, channelTypeMask, format, deviceTypes

##### Data fields

Type	Field	Description
<a href="#">StreamType</a>	type	<a href="#">StreamType</a> - defines purpose of the stream

Type	Field	Description
int	modemSubId	<b>Deprecated</b>  , use the <a href="#">StreamConfig::slotId</a> field instead of this
SlotId	slotId	SlotId - specifies the slot ID where the UICC card is inserted
uint32_t	sampleRate	Sample rate in Hz. Typical values are 8k, 16k, 32k and 48k. For Bluetooth use-cases, supported values are 8k and 16k
<a href="#">ChannelTypeMask</a>	<a href="#">channelTypeMask</a>	<a href="#">ChannelTypeMask</a> - defines audio channels to use
<a href="#">AudioFormat</a>	format	<a href="#">AudioFormat</a> - defines audio format
vector< <a href="#">DeviceType</a> >	deviceTypes	Defines the list of audio devices <a href="#">DeviceType</a> to use for this stream. For <a href="#">StreamType::PLAY</a> and <a href="#">StreamType::TONE_GENERATOR</a> , a single sink device should be specified. For <a href="#">StreamType::CAPTURE</a> , a single source device should be specified. For <a href="#">StreamType::VOICE_CALL</a> and <a href="#">StreamType::LOOPBACK</a> , both sink and source should be specified with sink as the first device and source as the second.
vector< <a href="#">Direction</a> >	voicePaths	For an in-call and hpcm audio usecase, this represents the voice path direction <a href="#">Direction</a>
<a href="#">FormatParams</a> *	formatParams	<a href="#">FormatParams</a> - defines compressed playback format
<a href="#">EcnrMode</a>	ecnrMode	<a href="#">EcnrMode</a> - true to enable ECNR on an ecall
bool	enableHpcm	True - if voice call is used with HPCM, false otherwise

#### 4.29.1.4 struct telux::audio::FormatInfo

Specifies the parameters when setting up streams for transcoding.

##### Data fields

Type	Field	Description
uint32_t	sampleRate	Sample rate in Hz, typical values 8k/16k/32k/48k Sample rate is a dummy paramter for voice stream and compressed playback
<a href="#">ChannelTypeMask</a>	mask	Refer to <a href="#">ChannelTypeMask</a>
<a href="#">AudioFormat</a>	format	Refer to <a href="#">AudioFormat</a>
<a href="#">FormatParams</a> *	params	Refer to <a href="#">FormatParams</a>



#### 4.29.1.5 class `telux::audio::IAudioListener`

Listener for the audio service availability. Refer to [telux::common::IServiceStatusListener](#) for details.

When audio service becomes unavailable, if the client was waiting on any outstanding response callbacks for APIs that were called just before the SSR, those response callbacks will not be called anymore.

For example, if `stream->setVolume(callback)` is called and SSR occurs then the 'callback' will be never invoked.

##### Public member functions

- virtual [~IAudioListener](#) ()

#### 4.29.1.5.1 Constructors and Destructors

##### 4.29.1.5.1.1 virtual `telux::audio::IAudioListener::~IAudioListener ( ) [virtual]`

Destructor of [IAudioListener](#).

#### 4.29.1.6 class `telux::audio::IAudioManager`

Provides the APIs to discover the supported audio devices, create streams, and subscribe for audio service status updates.

##### Public member functions

- virtual bool [isSubsystemReady](#) ()=0
- virtual [telux::common::ServiceStatus](#) [getServiceStatus](#) ()=0
- virtual `std::future< bool >` [onSubsystemReady](#) ()=0
- virtual [telux::common::Status](#) [getDevices](#) ([GetDevicesResponseCb](#) callback=nullptr)=0
- virtual [telux::common::Status](#) [getStreamTypes](#) ([GetStreamTypesResponseCb](#) callback=nullptr)=0
- virtual [telux::common::Status](#) [createStream](#) ([StreamConfig](#) streamConfig, [CreateStreamResponseCb](#) callback=nullptr)=0
- virtual [telux::common::Status](#) [createTranscoder](#) ([FormatInfo](#) input, [FormatInfo](#) output, [CreateTranscoderResponseCb](#) callback)=0
- virtual [telux::common::Status](#) [deleteStream](#) (`std::shared_ptr< IAudioStream >` stream, [DeleteStreamResponseCb](#) callback=nullptr)=0
- virtual [telux::common::Status](#) [registerListener](#) (`std::weak_ptr< IAudioListener >` listener)=0
- virtual [telux::common::Status](#) [deRegisterListener](#) (`std::weak_ptr< IAudioListener >` listener)=0
- virtual [telux::common::Status](#) [getCalibrationInitStatus](#) ([GetCalInitStatusResponseCb](#) callback)=0
- virtual [~IAudioManager](#) ()

### 4.29.1.6.1 Constructors and Destructors

**4.29.1.6.1.1** `virtual telux::audio::IAudioManager::~IAudioManager ( ) [virtual]`

Destructor of the [IAudioManager](#).

### 4.29.1.6.2 Member Function Documentation

**4.29.1.6.2.1** `virtual bool telux::audio::IAudioManager::isSubsystemReady ( ) [pure virtual]`

Checks if the audio service is ready for use.

#### Returns

True if the audio service is ready for use, otherwise, False

#### Deprecated

Use [getServiceStatus\(\)](#)

**4.29.1.6.2.2** `virtual telux::common::ServiceStatus telux::audio::IAudioManager::getServiceStatus ( ) [pure virtual]`

Gets the audio service status.

#### Returns

[telux::common::ServiceStatus::SERVICE\\_AVAILABLE](#) if the audio service is ready for use, [telux::common::ServiceStatus::SERVICE\\_UNAVAILABLE](#) if the audio service is temporarily unavailable (possibly undergoing initialization), [telux::common::ServiceStatus::SERVICE\\_FAILED](#) if the audio service needs re-initialization

**4.29.1.6.2.3** `virtual std::future<bool> telux::audio::IAudioManager::onSubsystemReady ( ) [pure virtual]`

Suggests when the audio service is ready.

#### Returns

Future to block on until the service status is updated to read

#### Deprecated

Use [telux::common::InitResponseCb](#) in [AudioFactory::getAudioManager\(\)](#)

**4.29.1.6.2.4** `virtual telux::common::Status telux::audio::IAudioManager::getDevices ( GetDevices← ResponseCb callback = nullptr ) [pure virtual]`

Gets the list of the supported audio devices.

**Parameters**

in	<i>callback</i>	Mandatory, callback that will receive the list
----	-----------------	--

**Returns**

Status [telux::common::Status::SUCCESS](#) if the request is initiated successfully, otherwise, an appropriate error code

#### 4.29.1.6.2.5 virtual telux::common::Status telux::audio::IAudioManager::getStreamTypes ( **GetStreamTypesResponseCb *callback = nullptr*** ) [pure virtual]

Gets the list of the supported stream types.

**Parameters**

in	<i>callback</i>	Mandatory, callback that will receive the list
----	-----------------	--

**Returns**

Status [telux::common::Status::SUCCESS](#) if the request is initiated successfully, otherwise, an appropriate error code

#### 4.29.1.6.2.6 virtual telux::common::Status telux::audio::IAudioManager::createStream ( **StreamConfig *streamConfig*, CreateStreamResponseCb *callback = nullptr*** ) [pure virtual]

Creates an audio stream with the parameters provided.

On platforms with access control enabled, the caller must have TELUX\_AUDIO\_VOICE, TELUX\_AUDIO\_PLAY, TELUX\_AUDIO\_CAPTURE, or TELUX\_AUDIO\_FACTORY\_TEST permission to invoke this method successfully.

**Parameters**

in	<i>streamConfig</i>	Parameters of the stream
in	<i>callback</i>	Mandatory, invoked to pass the stream created

**Returns**

Status [telux::common::Status::SUCCESS](#) if the request is initiated successfully, otherwise, an appropriate error code

#### 4.29.1.6.2.7 virtual telux::common::Status telux::audio::IAudioManager::createTranscoder ( **FormatInfo *input*, FormatInfo *output*, CreateTranscoderResponseCb *callback*** ) [pure virtual]

Set up the transcoder with the given parameters.

Transcoder instance is obtained in [CreateTranscoderResponseCb](#). It can be used only for a single transcoding operation.

On platforms with access control enabled, the caller must have TELUX\_AUDIO\_TRANSCODE

permission to invoke this method successfully.

### Parameters

in	<i>input</i>	Details of the input to transcode
in	<i>output</i>	Details of the transcoded output required
in	<i>callback</i>	Mandatory, invoked to pass the transcoder instance

### Returns

Status [telux::common::Status::SUCCESS](#) if the request is initiated successfully, otherwise, an appropriate error code

**4.29.1.6.2.8** `virtual telux::common::Status telux::audio::IAudioManager::deleteStream ( std::shared_ptr< IAudioStream > stream, DeleteStreamResponseCb callback = nullptr ) [pure virtual]`

Deletes the stream created with [createStream\(\)](#). It closes the stream and releases all resources allocated for this stream.

On platforms with access control enabled, the caller must have TELUX\_AUDIO\_VOICE, TELUX\_AUDIO\_PLAY, TELUX\_AUDIO\_CAPTURE, or TELUX\_AUDIO\_FACTORY\_TEST permission to invoke this method successfully.

### Parameters

in	<i>stream</i>	Stream to delete
in	<i>callback</i>	Optional, invoked to pass the result of the stream deletion

### Returns

Status [telux::common::Status::SUCCESS](#) if the request is initiated successfully, otherwise, an appropriate error code

**4.29.1.6.2.9** `virtual telux::common::Status telux::audio::IAudioManager::registerListener ( std::weak_ptr< IAudioListener > listener ) [pure virtual]`

Registers the given listener to get notified when the audio service status changes. The method [IAudioListener::onServiceStatusChange\(\)](#) is invoked to notify of the new status.

### Parameters

in	<i>listener</i>	Invoked to pass the new service status
----	-----------------	--

### Returns

[telux::common::Status::SUCCESS](#) if the listener is registered, otherwise, an appropriate error code

**4.29.1.6.2.10** virtual `telux::common::Status telux::audio::IAudioManager::deRegisterListener ( std::weak_ptr< IAudioListener > listener ) [pure virtual]`

Unregisters the given listener registered previously with [registerListener\(\)](#).

#### Parameters

in	<i>listener</i>	Listener to unregister
----	-----------------	------------------------

#### Returns

`telux::common::Status::SUCCESS` if the listener is unregistered, otherwise, an appropriate error code

**4.29.1.6.2.11** virtual `telux::common::Status telux::audio::IAudioManager::getCalibrationInitStatus ( GetCalInitStatusResponseCb callback ) [pure virtual]`

Gets the current initialization status of the audio calibration database (ACDB). This status is obtained in the [GetCalInitStatusResponseCb](#) callback.

#### Parameters

in	<i>callback</i>	Mandatory, invoked to pass the initialization status
----	-----------------	--

#### Returns

Status `telux::common::Status::SUCCESS` if the request is initiated successfully, otherwise, an appropriate error code

### 4.29.1.7 class `telux::audio::IAudioDevice`

Represents an audio device. Used in conjunction with [GetDevicesResponseCb](#).

#### Public member functions

- virtual `DeviceType getType ()=0`
- virtual `DeviceDirection getDirection ()=0`
- virtual `~IAudioDevice ()`

#### 4.29.1.7.1 Constructors and Destructors

**4.29.1.7.1.1** virtual `telux::audio::IAudioDevice::~~IAudioDevice ( ) [virtual]`

Destructor of the [IAudioDevice](#).

### 4.29.1.7.2 Member Function Documentation

#### 4.29.1.7.2.1 virtual DeviceType telux::audio::IAudioDevice::getType ( ) [pure virtual]

Gets the type of the audio device.

##### Returns

Type of the audio device

#### 4.29.1.7.2.2 virtual DeviceDirection telux::audio::IAudioDevice::getDirection ( ) [pure virtual]

Gets the direction of the audio device.

##### Returns

Direction of the audio device

## 4.29.2 Enumeration Type Documentation

### 4.29.2.1 enum telux::audio::DeviceType

Represents an audio device. Each device is mapped to its corresponding platform specific audio device type. This mapping is done in tel.conf file by the system integrator. Refer to README specified for the tel.conf file for details on the mapping of the DeviceType to a specific device on the HW platform.

##### Enumerator

**DEVICE\_TYPE\_NONE** Default device (invalid)  
**DEVICE\_TYPE\_SPEAKER** Sink device as per above mapping  
**DEVICE\_TYPE\_SPEAKER\_2** Sink device as per above mapping  
**DEVICE\_TYPE\_SPEAKER\_3** Sink device as per above mapping  
**DEVICE\_TYPE\_BT\_SCO\_SPEAKER** Bluetooth sink device for voice call  
**DEVICE\_TYPE\_PROXY\_SPEAKER** Virtual sink device as per above mapping  
**DEVICE\_TYPE\_MIC** Source device as per above mapping  
**DEVICE\_TYPE\_MIC\_2** Source device as per above mapping  
**DEVICE\_TYPE\_MIC\_3** Source device as per above mapping  
**DEVICE\_TYPE\_BT\_SCO\_MIC** Bluetooth source device for voice call  
**DEVICE\_TYPE\_PROXY\_MIC** Virtual mic connected over ethernet

### 4.29.2.2 enum telux::audio::DeviceDirection [strong]

Defines the direction of an audio device.

##### Enumerator

**NONE** Default direction (invalid)  
**RX** Audio will go out of the device, for example through a speaker (sink)  
**TX** Audio will come into the device, for example through a mic (source)

### 4.29.2.3 enum telux::audio::StreamType [strong]

Defines the type of the audio stream and the type's purpose.

#### Enumerator

**NONE** Default type (invalid)

**VOICE\_CALL** Used for audio over a cellular network

**PLAY** Used for playing audio, for example playing music and notifications

**CAPTURE** Used for capturing audio, for example recording sound using a mic

**LOOPBACK** Used for generating audio from a [DeviceDirection::RX](#) device, which is intended to be captured back by a [DeviceDirection::TX](#) device

**TONE\_GENERATOR** Used for single tone and DTMF tone generation

### 4.29.2.4 enum telux::audio::StreamDirection [strong]

Defines the direction of an audio stream.

#### Enumerator

**NONE** Default direction (invalid)

**RX** Specifies that the audio data will flow towards a sink device

**TX** Specifies that the audio data originates from a source device

### 4.29.2.5 enum telux::audio::AmrwbpFrameFormat [strong]

Defines the properties of the audio data for compressed playback and transcoding.

#### Enumerator

**UNKNOWN** Default format (invalid)

**TRANSPORT\_INTERFACE\_FORMAT** Unsupported

**FILE\_STORAGE\_FORMAT** Specifies that the audio content from AMR\* format file has been parsed and only actual audio content is sent for playback

### 4.29.2.6 enum telux::audio::EcnrMode [strong]

On a voice call stream, enables or disables echo cancellation and noise reduction (ECNR). Used with an audio device capable of supporting ECNR.

#### Enumerator

**DISABLE** Disables ECNR

**ENABLE** Enables ECNR

### 4.29.2.7 enum telux::audio::CalibrationInitStatus [strong]

Represents the state of the platform calibration for audio.

#### Enumerator

**UNKNOWN** Default state

**INIT\_SUCCESS** Platform calibrated successfully

**INIT\_FAILED** Platform calibration failed



## 4.30 Audio Streams

This section contains APIs related to Audio Stream operation.

### 4.30.1 Data Structure Documentation

#### 4.30.1.1 struct telux::audio::ChannelVolume

Defines the volume levels for a given audio channel.

##### Data fields

Type	Field	Description
<a href="#">ChannelType</a>	channelType	<a href="#">ChannelType</a> to which the volume level is associated.
float	vol	Volume level – minimum 0.0 and maximum 1.0

#### 4.30.1.2 struct telux::audio::StreamVolume

Defines the volume levels for the audio device.

##### Data fields

Type	Field	Description
vector< <a href="#">ChannelVolume</a> >	volume	List of the volume levels per channel, specified by <a href="#">ChannelVolume</a>
<a href="#">Stream↔ Direction</a>	dir	<a href="#">StreamDirection</a> associated with the device

#### 4.30.1.3 struct telux::audio::StreamMute

Specifies the mute state of the audio device.

##### Data fields

Type	Field	Description
bool	enable	True if the device is muted, False if the device is unmuted
<a href="#">Stream↔ Direction</a>	dir	<a href="#">StreamDirection</a> associated with the device

#### 4.30.1.4 struct telux::audio::DtmfTone

Defines the characteristics of the DTMF tone.

##### Data fields

Type	Field	Description
<a href="#">DtmfLowFreq</a>	lowFreq	Lower frequency associated with the DTMF tone
<a href="#">DtmfHighFreq</a>	highFreq	Higher frequency associated with the DTMF tone

Type	Field	Description
<a href="#">Stream</a> ↔ <a href="#">Direction</a>	direction	<a href="#">StreamDirection</a> associated with the stream

#### 4.30.1.5 class telux::audio::IVoiceListener

Listener for a DTMF tone detected event on a [StreamType::VOICE\\_CALL](#) stream.

##### Public member functions

- virtual void [onDtmfToneDetection](#) ([DtmfTone](#) dtmfTone)
- virtual [~IVoiceListener](#) ()

##### 4.30.1.5.1 Constructors and Destructors

###### 4.30.1.5.1.1 virtual telux::audio::IVoiceListener::~~IVoiceListener ( ) [virtual]

Destructor of the [IVoiceListener](#).

##### 4.30.1.5.2 Member Function Documentation

###### 4.30.1.5.2.1 virtual void telux::audio::IVoiceListener::onDtmfToneDetection ( [DtmfTone](#) *dtmfTone* ) [virtual]

Called when a DTMF tone is detected on a [StreamType::VOICE\\_CALL](#) stream. Used in conjunction with [IAudioVoiceStream::registerListener\(\)](#).

##### Parameters

in	<i>dtmfTone</i>	Contains details of the tone detected
----	-----------------	---------------------------------------

#### 4.30.1.6 class telux::audio::IPlayListener

Listener for events on a playback stream.

##### Public member functions

- virtual void [onReadyForWrite](#) ()
- virtual void [onPlayStopped](#) ()
- virtual [~IPlayListener](#) ()

##### 4.30.1.6.1 Constructors and Destructors

#### 4.30.1.6.1.1 virtual telux::audio::IPlayListener::~~IPlayListener ( ) [virtual]

Destructor of [IPlayListener](#).

#### 4.30.1.6.2 Member Function Documentation

##### 4.30.1.6.2.1 virtual void telux::audio::IPlayListener::onReadyForWrite ( ) [virtual]

Called when the audio pipeline is ready to accept the next buffer to play during compressed playback.

##### 4.30.1.6.2.2 virtual void telux::audio::IPlayListener::onPlayStopped ( ) [virtual]

Called when the compressed playback has stopped.

#### 4.30.1.7 class telux::audio::IAudioBuffer

Represents the buffer containing the audio data for playback when used with the [StreamType::PLAY](#) stream. Represents the audio data received when used with the [StreamType::CAPTURE](#) stream.

##### Public member functions

- virtual size\_t [getMinSize](#) ()=0
- virtual size\_t [getMaxSize](#) ()=0
- virtual uint8\_t \* [getRawBuffer](#) ()=0
- virtual uint32\_t [getDataSize](#) ()=0
- virtual void [setDataSize](#) (uint32\_t size)=0
- virtual [telux::common::Status](#) [reset](#) ()=0
- virtual [~IAudioBuffer](#) ()

#### 4.30.1.7.1 Constructors and Destructors

##### 4.30.1.7.1.1 virtual telux::audio::IAudioBuffer::~~IAudioBuffer ( ) [virtual]

Destructor of the [IAudioBuffer](#).

#### 4.30.1.7.2 Member Function Documentation

##### 4.30.1.7.2.1 virtual size\_t telux::audio::IAudioBuffer::getMinSize ( ) [pure virtual]

For the [StreamType::PLAY](#) stream, specifies the optimal number of bytes that must be sent for playback. For the [StreamType::CAPTURE](#) stream, specifies the optimal number of bytes that can be read.

##### Returns

Optimal size (in bytes)

**4.30.1.7.2.2 virtual size\_t telux::audio::IAudioBuffer::getMaxSize( ) [pure virtual]**

For the [StreamType::PLAY](#) stream, specifies the maximum number of bytes that can be sent for playback. For the [StreamType::CAPTURE](#) stream, specifies the maximum number of bytes that can be read.

**Returns**

Maximum size (in bytes)

**4.30.1.7.2.3 virtual uint8\_t\* telux::audio::IAudioBuffer::getRawBuffer( ) [pure virtual]**

Gives the managed raw buffer. It is freed when [IAudioBuffer](#) is destructed. For the [StreamType::PLAY](#) stream, the actual audio samples should be copied into this raw buffer for playback. For the [StreamType::CAPTURE](#) stream, the actual audio contents are obtained from this buffer.

**Returns**

Managed raw buffer

**4.30.1.7.2.4 virtual uint32\_t telux::audio::IAudioBuffer::getDataSize( ) [pure virtual]**

For the [StreamType::CAPTURE](#) stream, specifies how many bytes were read. Not used for the [StreamType::PLAY](#) stream.

**Returns**

Size of the valid data bytes in the raw buffer

**4.30.1.7.2.5 virtual void telux::audio::IAudioBuffer::setDataSize( uint32\_t size ) [pure virtual]**

For the [StreamType::PLAY](#) stream, specifies how many bytes should be played. Not used for the [StreamType::CAPTURE](#) stream.

**Returns**

Size of the valid data bytes in the raw buffer

**4.30.1.7.2.6 virtual telux::common::Status telux::audio::IAudioBuffer::reset( ) [pure virtual]**

Clears the contents of the managed raw buffer.

**Returns**

[telux::common::Status::SUCCESS](#) if the buffer is cleared successfully, otherwise, an appropriate error code

### 4.30.1.8 class telux::audio::IStreamBuffer

Implements the [IAudioBuffer](#) interface to give contextual meaning to its methods based on the [StreamType](#) type associated with the stream, with which this buffer will be used.

#### Public member functions

- virtual [~IStreamBuffer](#) ()

#### 4.30.1.8.1 Constructors and Destructors

##### 4.30.1.8.1.1 virtual telux::audio::IStreamBuffer::~~IStreamBuffer ( ) [virtual]

Destructor of the [IStreamBuffer](#).

### 4.30.1.9 class telux::audio::IAudioStream

Base class for all audio stream types. Contains the common properties and methods.

#### Public member functions

- virtual [StreamType](#) [getType](#) ()=0
- virtual [telux::common::Status](#) [setDevice](#) (std::vector< [DeviceType](#) > devices, [telux::common::ResponseCallback](#) callback=nullptr)=0
- virtual [telux::common::Status](#) [getDevice](#) ([GetStreamDeviceResponseCb](#) callback=nullptr)=0
- virtual [telux::common::Status](#) [setVolume](#) ([StreamVolume](#) volume, [telux::common::ResponseCallback](#) callback=nullptr)=0
- virtual [telux::common::Status](#) [getVolume](#) ([StreamDirection](#) dir, [GetStreamVolumeResponseCb](#) callback=nullptr)=0
- virtual [telux::common::Status](#) [setMute](#) ([StreamMute](#) mute, [telux::common::ResponseCallback](#) callback=nullptr)=0
- virtual [telux::common::Status](#) [getMute](#) ([StreamDirection](#) dir, [GetStreamMuteResponseCb](#) callback=nullptr)=0
- virtual [~IAudioStream](#) ()

#### 4.30.1.9.1 Constructors and Destructors

##### 4.30.1.9.1.1 virtual telux::audio::IAudioStream::~~IAudioStream ( ) [virtual]

Destructor of the [IAudioStream](#).

#### 4.30.1.9.2 Member Function Documentation

**4.30.1.9.2.1 virtual StreamType telux::audio::IAudioStream::getType ( ) [pure virtual]**

Gets the [StreamType](#) associated with the stream.

**Returns**

Type of the stream

**4.30.1.9.2.2 virtual telux::common::Status telux::audio::IAudioStream::setDevice ( std::vector< DeviceType > devices, telux::common::ResponseCallback callback = nullptr ) [pure virtual]**

Associates the given audio device with the stream.

Applicable for [StreamType::VOICE\\_CALL](#), [StreamType::PLAY](#), and [StreamType::CAPTURE](#) only.

For [StreamType::VOICE\\_CALL](#), the stream must be started using [IAudioVoiceStream::startAudio\(\)](#) to make the device effective.

**Parameters**

in	<i>devices</i>	List of the audio devices to use with the stream
in	<i>callback</i>	Optional, invoked to confirm if the device is associated

**Returns**

Status [telux::common::Status::SUCCESS](#) if the request is initiated successfully, otherwise, an appropriate error code

**4.30.1.9.2.3 virtual telux::common::Status telux::audio::IAudioStream::getDevice ( GetStreamDevice↔ ResponseCb callback = nullptr ) [pure virtual]**

Gets the list of the audio devices associated with the stream.

Applicable for [StreamType::VOICE\\_CALL](#), [StreamType::PLAY](#), and [StreamType::CAPTURE](#) only.

**Parameters**

in	<i>callback</i>	Mandatory, invoked to pass the associated device
----	-----------------	--

**Returns**

Status [telux::common::Status::SUCCESS](#) if the request is initiated successfully, otherwise, an appropriate error code

**4.30.1.9.2.4 virtual telux::common::Status telux::audio::IAudioStream::setVolume ( StreamVolume volume, telux::common::ResponseCallback callback = nullptr ) [pure virtual]**

Sets the volume level of the audio device.

For [StreamType::VOICE\\_CALL](#), direction must be [StreamDirection::RX](#).

Applicable for [StreamType::VOICE\\_CALL](#), [StreamType::PLAY](#), and [StreamType::CAPTURE](#) only.

Direction of the stream is ignored.

#### Parameters

in	<i>volume</i>	Specifies the volume level and the stream's direction
in	<i>callback</i>	Optional, invoked to confirm if the volume level is set

#### Returns

Status [telux::common::Status::SUCCESS](#) if the request is initiated successfully, otherwise, an appropriate error code

#### 4.30.1.9.2.5 virtual telux::common::Status telux::audio::IAudioStream::getVolume ( StreamDirection dir, GetStreamVolumeResponseCb callback = nullptr ) [pure virtual]

Gets the current volume level of the audio device.

For [StreamType::VOICE\\_CALL](#), direction must be [StreamDirection::RX](#).

Applicable for [StreamType::VOICE\\_CALL](#), [StreamType::PLAY](#), and [StreamType::CAPTURE](#) only.

Direction of the stream is ignored.

#### Parameters

in	<i>dir</i>	Direction of the stream associated with the device
in	<i>callback</i>	Mandatory, invoked to pass the volume read

#### Returns

Status [telux::common::Status::SUCCESS](#) if the request is initiated successfully, otherwise, an appropriate error code

#### 4.30.1.9.2.6 virtual telux::common::Status telux::audio::IAudioStream::setMute ( StreamMute mute, telux::common::ResponseCallback callback = nullptr ) [pure virtual]

Mute or unmute the stream as specified by the [StreamMute](#) provided.

Applicable for [StreamType::VOICE\\_CALL](#), [StreamType::PLAY](#), and [StreamType::CAPTURE](#) only.

For [StreamType::VOICE\\_CALL](#), the stream must be started using [IAudioVoiceStream::startAudio\(\)](#) before setting the mute state.

Direction of the stream is ignored.

#### Parameters

in	<i>mute</i>	Defines the stream is to be muted or unmuted
in	<i>callback</i>	Optional, invoked to confirm if the stream is muted/unmuted

## Returns

Status [telux::common::Status::SUCCESS](#) if the request is initiated successfully, otherwise, an appropriate error code

### 4.30.1.9.2.7 virtual [telux::common::Status](#) [telux::audio::IAudioStream::getMute](#) ( [StreamDirection](#) *dir*, [GetStreamMuteResponseCb](#) *callback = nullptr* ) [pure virtual]

Gets the current mute state of the audio stream.

Applicable for [StreamType::VOICE\\_CALL](#), [StreamType::PLAY](#), and [StreamType::CAPTURE](#) only.

For [StreamType::VOICE\\_CALL](#), the stream must be started using [IAudioVoiceStream::startAudio\(\)](#) before reading the mute state.

Direction of the stream is ignored.

## Parameters

in	<i>dir</i>	Direction of the stream
in	<i>callback</i>	Mandatory, invoked to pass the mute state

## Returns

Status [telux::common::Status::SUCCESS](#) if the request is initiated successfully, otherwise, an appropriate error code

### 4.30.1.10 class [telux::audio::IAudioVoiceStream](#)

Represents the stream created with the [StreamType::VOICE\\_CALL](#) type. Provides methods to establish a voice call on a cellular network, and play and detect DTMF tones.

## Public member functions

- virtual [telux::common::Status](#) [startAudio](#) ([telux::common::ResponseCallback](#) *callback=nullptr*)=0
- virtual [telux::common::Status](#) [stopAudio](#) ([telux::common::ResponseCallback](#) *callback=nullptr*)=0
- virtual [telux::common::Status](#) [playDtmfTone](#) ([DtmfTone](#) *dtmfTone*, [uint16\\_t](#) *duration*, [uint16\\_t](#) *gain*, [telux::common::ResponseCallback](#) *callback=nullptr*)=0
- virtual [telux::common::Status](#) [stopDtmfTone](#) ([StreamDirection](#) *direction*, [telux::common::ResponseCallback](#) *callback=nullptr*)=0
- virtual [telux::common::Status](#) [registerListener](#) ([std::weak\\_ptr< IVoiceListener >](#) *listener*, [telux::common::ResponseCallback](#) *callback=nullptr*)=0
- virtual [telux::common::Status](#) [deRegisterListener](#) ([std::weak\\_ptr< IVoiceListener >](#) *listener*)=0
- virtual [~IAudioVoiceStream](#) ()



### 4.30.1.10.1 Constructors and Destructors

#### 4.30.1.10.1.1 virtual telux::audio::IAudioVoiceStream::~IAudioVoiceStream ( ) [virtual]

Destructor of the [IAudioVoiceStream](#).

### 4.30.1.10.2 Member Function Documentation

#### 4.30.1.10.2.1 virtual telux::common::Status telux::audio::IAudioVoiceStream::startAudio ( telux::common::ResponseCallback *callback* = nullptr ) [pure virtual]

Starts a voice call stream.

##### Parameters

<i>in</i>	<i>callback</i>	Optional, invoked to confirm if the stream has started
-----------	-----------------	--

##### Returns

Status [telux::common::Status::SUCCESS](#) if the request is initiated successfully, otherwise, an appropriate error code

#### 4.30.1.10.2.2 virtual telux::common::Status telux::audio::IAudioVoiceStream::stopAudio ( telux::common::ResponseCallback *callback* = nullptr ) [pure virtual]

Stops a voice call stream.

##### Parameters

<i>in</i>	<i>callback</i>	Optional, invoked to confirm if the stream has stopped
-----------	-----------------	--

##### Returns

Status [telux::common::Status::SUCCESS](#) if the request is initiated successfully, otherwise, an appropriate error code

#### 4.30.1.10.2.3 virtual telux::common::Status telux::audio::IAudioVoiceStream::playDtmfTone ( DtmfTone *dtmfTone*, uint16\_t *duration*, uint16\_t *gain*, telux::common::ResponseCallback *callback* = nullptr ) [pure virtual]

Generates a DTMF tone on a local device (on RX path) associated with the active voice call stream.

##### Parameters

<i>in</i>	<i>dtmfTone</i>	Specifies the tone's properties
<i>in</i>	<i>duration</i>	Duration (in milliseconds) for which the tone is played. Set it to <a href="#">INFINITE_TONE_DURATION</a> to play indefinitely
<i>in</i>	<i>gain</i>	Volume level of the tone, valid value range is 0 to 4000
<i>in</i>	<i>callback</i>	Optional, invoked to confirm if the tone play has started

**Returns**

Status [telux::common::Status::SUCCESS](#) if the request is initiated successfully, otherwise, an appropriate error code

**4.30.1.10.2.4** virtual [telux::common::Status](#) [telux::audio::IAudioVoiceStream::stopDtmfTone](#) ( [StreamDirection](#) *direction*, [telux::common::ResponseCallback](#) *callback = nullptr* )  
[pure virtual]

If [IAudioVoiceStream::playDtmfTone\(\)](#) was called with the duration set to [INFINITE\\_DTMF\\_DURATION](#), then this method stops playing the DTMF tone.

**Parameters**

in	<i>direction</i>	Direction of the stream
in	<i>callback</i>	Optional, invoked to confirm if the tone play has stopped

**Returns**

Status [telux::common::Status::SUCCESS](#) if the request is initiated successfully, otherwise, an appropriate error code

**4.30.1.10.2.5** virtual [telux::common::Status](#) [telux::audio::IAudioVoiceStream::registerListener](#) ( [std::weak\\_ptr< IVoiceListener >](#) *listener*, [telux::common::ResponseCallback](#) *callback = nullptr* ) [pure virtual]

Registers the given listener to get notified whenever a DTMF tone is detected on a voice call stream. Used in conjunction with [IVoiceListener::onDtmfToneDetection\(\)](#).

**Parameters**

in	<i>listener</i>	Receives the DTMF tone detected event
in	<i>callback</i>	Optional, invoked to confirm if the registration is successful

**Returns**

[telux::common::Status::SUCCESS](#) if the listener is registered, otherwise, an appropriate error code

**4.30.1.10.2.6** virtual [telux::common::Status](#) [telux::audio::IAudioVoiceStream::deRegisterListener](#) ( [std::weak\\_ptr< IVoiceListener >](#) *listener* ) [pure virtual]

Unregisters the given listener registered with [IAudioVoiceStream::registerListener\(\)](#).

**Parameters**

in	<i>listener</i>	Listener to unregister
----	-----------------	------------------------

**Returns**

[telux::common::Status::SUCCESS](#) if the listener is unregistered, otherwise, an appropriate error code

### 4.30.1.11 class telux::audio::IAudioPlayStream

Represents the stream created with the [StreamType::PLAY](#) type. Provides the methods to play the audio.

#### Public member functions

- virtual `std::shared_ptr< IStreamBuffer > getStreamBuffer ()=0`
- virtual `telux::common::Status write (std::shared_ptr< IStreamBuffer > buffer, WriteResponseCb callback=nullptr)=0`
- virtual `telux::common::Status stopAudio (StopType stopType, telux::common::ResponseCallback callback=nullptr)=0`
- virtual `telux::common::Status registerListener (std::weak_ptr< IPlayListener > listener)=0`
- virtual `telux::common::Status deRegisterListener (std::weak_ptr< IPlayListener > listener)=0`
- virtual `~IAudioPlayStream ()`

#### 4.30.1.11.1 Constructors and Destructors

4.30.1.11.1 virtual `telux::audio::IAudioPlayStream::~~IAudioPlayStream ( ) [virtual]`

Destructor of the [IAudioPlayStream](#).

#### 4.30.1.11.2 Member Function Documentation

4.30.1.11.2.1 virtual `std::shared_ptr<IStreamBuffer> telux::audio::IAudioPlayStream::getStreamBuffer ( ) [pure virtual]`

Gets an audio buffer containing the audio samples to play.

#### Returns

[IStreamBuffer](#) instance or `nullptr` if memory allocation fails

4.30.1.11.2.2 virtual `telux::common::Status telux::audio::IAudioPlayStream::write ( std::shared_ptr< IStreamBuffer > buffer, WriteResponseCb callback = nullptr ) [pure virtual]`

Sends the audio data for playback. First write starts the playback operation.

For uncompressed playback (for example, [AudioFormat::PCM\\_16BIT\\_SIGNED](#)), the next buffer can be sent the moment [telux::common::ErrorCode::SUCCESS](#) is received by [WriteResponseCb](#).

For compressed playback (for example, [AudioFormat::AMR\\*](#)), the next buffer should be sent only after both; (a) [telux::common::ErrorCode::SUCCESS](#) is received by [WriteResponseCb](#) (indicating that the current buffer has been pushed in the pipeline for playback) and (b) [IPlayListener::onReadyForWrite\(\)](#) has been invoked (indicating that the pipeline can accommodate the next buffer).

**Parameters**

in	<i>buffer</i>	Contains the audio data to play
in	<i>callback</i>	Optional, invoked to confirm if the data is played successfully

**Returns**

Status [telux::common::Status::SUCCESS](#) if the request is initiated successfully, otherwise, an appropriate error code

#### 4.30.1.11.2.3 virtual `telux::common::Status telux::audio::IAudioPlayStream::stopAudio ( StopType stopType, telux::common::ResponseCallback callback = nullptr ) [pure virtual]`

Finishes the ongoing compressed playback in a way specified by the [StopType](#) provided.

**Parameters**

in	<i>callback</i>	Optional, invoked to confirm if the playback has finished
in	<i>stopType</i>	Defines how to finish playback

**Returns**

Status [telux::common::Status::SUCCESS](#) if the request is initiated successfully, otherwise, an appropriate error code

#### 4.30.1.11.2.4 virtual `telux::common::Status telux::audio::IAudioPlayStream::registerListener ( std::weak_ptr< IPlayListener > listener ) [pure virtual]`

Registers the given listener to receive events; (a) pipeline is ready to accept the next buffer for compressed playback (b) compressed playback has stopped. Events are received by the listener implementing the [IPlayListener](#) interface.

**Parameters**

in	<i>listener</i>	Receives the playstream events
----	-----------------	--------------------------------

**Returns**

[telux::common::Status::SUCCESS](#) if the listener is registered, otherwise, an appropriate error code

#### 4.30.1.11.2.5 virtual `telux::common::Status telux::audio::IAudioPlayStream::deRegisterListener ( std::weak_ptr< IPlayListener > listener ) [pure virtual]`

Unregisters the given listener registered with [IAudioPlayStream::registerListener\(\)](#).

**Parameters**

in	<i>listener</i>	Listener to unregister
----	-----------------	------------------------

**Returns**

[telux::common::Status::SUCCESS](#) if the listener is unregistered, otherwise, an appropriate error code

**4.30.1.12 class telux::audio::IAudioCaptureStream**

Represents the stream created with the [StreamType::CAPTURE](#) type. Provides the methods to read the captured audio.

**Public member functions**

- virtual `std::shared_ptr< IStreamBuffer > getStreamBuffer ()=0`
- virtual `telux::common::Status read (std::shared_ptr< IStreamBuffer > buffer, uint32_t bytesToRead, ReadResponseCb callback=nullptr)=0`
- virtual `~IAudioCaptureStream ()`

**4.30.1.12.1 Constructors and Destructors****4.30.1.12.1.1 virtual telux::audio::IAudioCaptureStream::~IAudioCaptureStream ( ) [virtual]**

Destructor of the [IAudioCaptureStream](#).

**4.30.1.12.2 Member Function Documentation****4.30.1.12.2.1 virtual std::shared\_ptr<IStreamBuffer> telux::audio::IAudioCaptureStream::getStreamBuffer ( ) [pure virtual]**

Gets an audio buffer that will contain the audio data read.

**Returns**

[IStreamBuffer](#) instance or nullptr if memory allocation fails

**4.30.1.12.2.2 virtual telux::common::Status telux::audio::IAudioCaptureStream::read ( std::shared\_ptr< IStreamBuffer > *buffer*, uint32\_t *bytesToRead*, ReadResponseCb *callback* = *nullptr* ) [pure virtual]**

Read the audio data from the source device associated with this stream. Data captured will be received by the [ReadResponseCb](#) callback.

First read call starts the capture operation.

**Parameters**

in	<i>buffer</i>	Buffer in which data should be read
in	<i>bytesToRead</i>	Length of the data (in bytes) to read
in	<i>callback</i>	Mandatory, receives the captured data

## Returns

Status [telux::common::Status::SUCCESS](#) if the request is initiated successfully, otherwise, an appropriate error code

### 4.30.1.13 class telux::audio::IAudioLoopbackStream

Represents the stream created with the [StreamType::LOOPBACK](#) type. Provides the methods to start and stop the audio loopback operation.

#### Public member functions

- virtual [telux::common::Status](#) startLoopback ([telux::common::ResponseCallback](#) callback=nullptr)=0
- virtual [telux::common::Status](#) stopLoopback ([telux::common::ResponseCallback](#) callback=nullptr)=0
- virtual [~IAudioLoopbackStream](#) ()

#### 4.30.1.13.1 Constructors and Destructors

4.30.1.13.1 virtual [telux::audio::IAudioLoopbackStream::~~IAudioLoopbackStream](#) ( ) [virtual]

Destructor of the [IAudioLoopbackStream](#).

#### 4.30.1.13.2 Member Function Documentation

4.30.1.13.2.1 virtual [telux::common::Status](#) [telux::audio::IAudioLoopbackStream::startLoopback](#) ([telux::common::ResponseCallback](#) *callback = nullptr*) [pure virtual]

Starts looping back the audio between the source and sink devices associated with this stream.

#### Parameters

in	<i>callback</i>	Optional, invoked to confirm if the loopback has started
----	-----------------	--

#### Returns

Status [telux::common::Status::SUCCESS](#) if the request is initiated successfully, otherwise, an appropriate error code

4.30.1.13.2.2 virtual [telux::common::Status](#) [telux::audio::IAudioLoopbackStream::stopLoopback](#) ([telux::common::ResponseCallback](#) *callback = nullptr*) [pure virtual]

Starts looping back the audio between the source and sink devices associated with this stream.

#### Parameters

in	<i>callback</i>	Optional, invoked to confirm if the loopback has stopped
----	-----------------	--

## Returns

Status [telux::common::Status::SUCCESS](#) if the request is initiated successfully, otherwise, an appropriate error code

### 4.30.1.14 class telux::audio::IAudioToneGeneratorStream

Represents the stream created with the [StreamType::TONE\\_GENERATOR](#) type. Provides the methods to play an audio tone.

#### Public member functions

- virtual [telux::common::Status](#) [playTone](#) (std::vector< uint16\_t > freq, uint16\_t duration, uint16\_t gain, [telux::common::ResponseCallback](#) callback=nullptr)=0
- virtual [telux::common::Status](#) [stopTone](#) ([telux::common::ResponseCallback](#) callback=nullptr)=0
- virtual [~IAudioToneGeneratorStream](#) ()

#### 4.30.1.14.1 Constructors and Destructors

4.30.1.14.1.1 virtual [telux::audio::IAudioToneGeneratorStream::~~IAudioToneGeneratorStream](#) ( )  
[virtual]

Destructor of the [IAudioToneGeneratorStream](#).

#### 4.30.1.14.2 Member Function Documentation

4.30.1.14.2.1 virtual [telux::common::Status](#) [telux::audio::IAudioToneGeneratorStream::playTone](#) ( std::vector< uint16\_t > *freq*, uint16\_t *duration*, uint16\_t *gain*, [telux::common::ResponseCallback](#) *callback* = nullptr ) [pure virtual]

Plays an audio tone with the given parameters.

#### Parameters

in	<i>freq</i>	Frequency of the tone. For single tone, freq[0] should be provided. For dual tone, both freq[0] and freq[1] should be provided.
in	<i>duration</i>	Duration (in milliseconds) for which the tone is played. Set it to <a href="#">INFINITE_TONE_DURATION</a> to play indefinitely
in	<i>gain</i>	Defines the volume level of the tone, valid value range is 0 to 4000
in	<i>callback</i>	Optional, invoked to confirm if the tone play started

## Returns

Status [telux::common::Status::SUCCESS](#) if the request is initiated successfully, otherwise, an appropriate error code

#### 4.30.1.14.2.2 virtual telux::common::Status telux::audio::IAudioToneGeneratorStream::stopTone ( telux::common::ResponseCallback *callback* = *nullptr* ) [pure virtual]

If the `IAudioToneGeneratorStream::playTone()` was called with the `INFINITE_TONE_DURATION` duration, then this method stops playing the tone.

##### Parameters

<code>in</code>	<code>callback</code>	Optional, invoked to confirm if the tone play has stopped
-----------------	-----------------------	---

##### Returns

Status `telux::common::Status::SUCCESS` if the request is initiated successfully, otherwise, an appropriate error code

## 4.30.2 Enumeration Type Documentation

### 4.30.2.1 enum telux::audio::Direction [strong]

Used for an in-call playback/capture and HPCM usecases. Represents the direction of the audio data flow.

#### Enumerator

- RX** Indicates voice downlink path (cellular network to a device)
- TX** Indicates voice uplink path (device to a cellular network)

### 4.30.2.2 enum telux::audio::ChannelType

Adds positional perspective to the audio data in a given audio frame. For example, in a 2-speaker audio system, `ChannelType::LEFT` may represent audio played on speaker-1 while `ChannelType::RIGHT` represents audio played on speaker-2.

#### Enumerator

- LEFT** Specifies the left channel
- RIGHT** Specifies the right channel

### 4.30.2.3 enum telux::audio::AudioFormat [strong]

Specifies how audio data is represented (for example, endianness and number of bits) for storage or exchanging among various audio software and hardware layers.

#### Enumerator

- UNKNOWN** Default format (invalid)
- PCM\_16BIT\_SIGNED** PCM signed 16 bits
- AMRNB** Adaptive multirate narrow band format
- AMRWB** Adaptive multirate wide band format
- AMRWB\_PLUS** Extended adaptive multirate wide band format



#### 4.30.2.4 enum telux::audio::DtmfLowFreq [strong]

When generating a DTMF tone, defines the value of the low frequency component.

##### Enumerator

**FREQ\_697** 697 Hz  
**FREQ\_770** 770 Hz  
**FREQ\_852** 852 Hz  
**FREQ\_941** 941 Hz

#### 4.30.2.5 enum telux::audio::DtmfHighFreq [strong]

When generating a DTMF tone, defines the value of the high frequency component.

##### Enumerator

**FREQ\_1209** 1209 Hz  
**FREQ\_1336** 1336 Hz  
**FREQ\_1477** 1477 Hz  
**FREQ\_1633** 1633 Hz

#### 4.30.2.6 enum telux::audio::StopType [strong]

Defines the behavior for how a compressed audio format playback should be finished.

##### Enumerator

**FORCE\_STOP** Stop playing immediately and discard all pending audio samples  
**STOP\_AFTER\_PLAY** Stop playing after all samples in the pipeline have been played

## 4.31 Transcoder

This section contains APIs related to Audio Transcoder operation.

### 4.31.1 Data Structure Documentation

#### 4.31.1.1 class telux::audio::ITranscodeListener

Listener for events during transcoding.

##### Public member functions

- virtual void [onReadyForWrite](#) ()
- virtual [~ITranscodeListener](#) ()

##### 4.31.1.1.1 Constructors and Destructors

###### 4.31.1.1.1.1 virtual telux::audio::ITranscodeListener::~~ITranscodeListener ( ) [virtual]

Destructor of [ITranscodeListener](#).

##### 4.31.1.1.2 Member Function Documentation

###### 4.31.1.1.2.1 virtual void telux::audio::ITranscodeListener::onReadyForWrite ( ) [virtual]

Called when the audio pipeline is ready to accept the next buffer containing data to transcode.

#### 4.31.1.2 class telux::audio::ITranscoder

Provides the methods for transcoding the compressed audio data.

##### Public member functions

- virtual std::shared\_ptr< [IAudioBuffer](#) > [getWriteBuffer](#) ()=0
- virtual std::shared\_ptr< [IAudioBuffer](#) > [getReadBuffer](#) ()=0
- virtual [telux::common::Status](#) [write](#) (std::shared\_ptr< [IAudioBuffer](#) > buffer, uint32\_t isLastBuffer, [TranscoderWriteResponseCb](#) callback=nullptr)=0
- virtual [telux::common::Status](#) [tearDown](#) ([telux::common::ResponseCallback](#) callback=nullptr)=0
- virtual [telux::common::Status](#) [read](#) (std::shared\_ptr< [IAudioBuffer](#) > buffer, uint32\_t bytesToRead, [TranscoderReadResponseCb](#) callback=nullptr)=0
- virtual [telux::common::Status](#) [registerListener](#) (std::weak\_ptr< [ITranscodeListener](#) > listener)=0
- virtual [telux::common::Status](#) [deRegisterListener](#) (std::weak\_ptr< [ITranscodeListener](#) > listener)=0
- virtual [~ITranscoder](#) ()

### 4.31.1.2.1 Constructors and Destructors

#### 4.31.1.2.1.1 virtual telux::audio::ITranscoder::~~ITranscoder ( ) [virtual]

Destructor of the [ITranscoder](#).

### 4.31.1.2.2 Member Function Documentation

#### 4.31.1.2.2.1 virtual std::shared\_ptr<IAudioBuffer> telux::audio::ITranscoder::getWriteBuffer ( ) [pure virtual]

Gets a buffer for sending the data for transcoding.

#### Returns

[IAudioBuffer](#) instance representing the buffer or nullptr if allocation failed

#### 4.31.1.2.2.2 virtual std::shared\_ptr<IAudioBuffer> telux::audio::ITranscoder::getReadBuffer ( ) [pure virtual]

Gets a buffer that will contain the transcoded data.

#### Returns

[IAudioBuffer](#) instance representing the buffer or nullptr if allocation failed

#### 4.31.1.2.2.3 virtual telux::common::Status telux::audio::ITranscoder::write ( std::shared\_ptr<IAudioBuffer > *buffer*, uint32\_t *isLastBuffer*, TranscoderWriteResponseCb *callback* = nullptr ) [pure virtual]

Sends the compressed data for transcoding. First write starts the transcoding operation.

Internally, a pipeline is maintained for the data to transcode. The application should send the next data for transcoding only when the pipeline can accommodate more data. This readiness is indicated by calling the [ITranscodeListener::onReadyForWrite\(\)](#) method.

#### Parameters

in	<i>buffer</i>	Contains the data to transcode
in	<i>isLastBuffer</i>	Marks that this is the last chunk of the data to transcode
in	<i>callback</i>	Optional, invoked to pass the status of pushing the data in the pipeline

#### Returns

[telux::common::Status::SUCCESS](#) if the data is sent, otherwise, an appropriate error code

**4.31.1.2.2.4** `virtual telux::common::Status telux::audio::ITranscoder::tearDown ( telux::common::ResponseCallback callback = nullptr ) [pure virtual]`

Destroys the [ITranscoder](#) instance created with [IAudioManager::createTranscoder\(\)](#). This must be called after the transcoding is finished.

#### Parameters

in	<i>callback</i>	Optional, invoked to pass the result of the destruction
----	-----------------	---

#### Returns

[telux::common::Status::SUCCESS](#) if the teardown was initiated, otherwise, an appropriate error code

**4.31.1.2.2.5** `virtual telux::common::Status telux::audio::ITranscoder::read ( std::shared_ptr< IAudioBuffer > buffer, uint32_t bytesToRead, TranscoderReadResponseCb callback = nullptr ) [pure virtual]`

Initiates a read request to fetch the transcoded data. Transcoded data will be by the [TranscoderReadResponseCb](#) callback.

#### Parameters

in	<i>buffer</i>	Buffer that will contain the transcoded data
in	<i>bytesToRead</i>	Length of the data to fetch
in	<i>callback</i>	Optional, invoked to pass the transcoded data

#### Returns

[telux::common::Status::SUCCESS](#) if the request is sent, otherwise, an appropriate error code

**4.31.1.2.2.6** `virtual telux::common::Status telux::audio::ITranscoder::registerListener ( std::weak_ptr< ITranscodeListener > listener ) [pure virtual]`

Registers the given listener to know 'when the pipeline is ready to accept the next buffer' for transcoding. Event is received by the [ITranscodeListener::onReadyForWrite\(\)](#) method.

#### Parameters

in	<i>listener</i>	Receives the events during transcoding
----	-----------------	--

#### Returns

[telux::common::Status::SUCCESS](#) if the listener is registered, otherwise, an appropriate error code

**4.31.1.2.2.7** `virtual telux::common::Status telux::audio::ITranscoder::deRegisterListener ( std::weak_ptr< ITranscodeListener > listener ) [pure virtual]`

Unregisters the given listener registered with [ITranscoder::registerListener\(\)](#).

**Parameters**

in	<i>listener</i>	Listener to unregister
----	-----------------	------------------------

**Returns**

[telux::common::Status::SUCCESS](#) if the listener is unregistered, otherwise, an appropriate error code

## 4.32 Thermal

- [Thermal Management](#)
- [Thermal Shutdown Management](#)

This section contains APIs related to thermal.

## 4.33 Thermal Management

This section contains APIs related to Thermal Management such as read list of thermal zones, cooling devices and binding info.

### 4.33.1 Data Structure Documentation

#### 4.33.1.1 class telux::therm::ThermalFactory

[ThermalFactory](#) allows creation of thermal manager.

##### Public member functions

- virtual std::shared\_ptr< [IThermalManager](#) > [getThermalManager](#) (telux::common::InitResponseCb callback=nullptr, telux::common::ProcType operType=telux::common::ProcType::LOCAL\_PROC)=0
- virtual std::shared\_ptr< [IThermalShutdownManager](#) > [getThermalShutdownManager](#) (telux::common::InitResponseCb callback=nullptr)=0

##### Static Public Member Functions

- static [ThermalFactory](#) & [getInstance](#) ()

#### 4.33.1.1.1 Member Function Documentation

##### 4.33.1.1.1.1 static ThermalFactory& telux::therm::ThermalFactory::getInstance ( ) [static]

Get Thermal Factory instance.

##### 4.33.1.1.1.2 virtual std::shared\_ptr<IThermalManager> telux::therm::ThermalFactory::getThermal↔ Manager ( telux::common::InitResponseCb callback = nullptr, telux::common::ProcType operType = telux::common::ProcType::LOCAL\_PROC ) [pure virtual]

Get thermal manager instance associated with a [telux::common::ProcType](#) to get list of thermal zones (sensors) and cooling devices supported by the device

On platforms with Access control enabled, Caller needs to have TELUX\_THERM\_DATA\_READ permission to invoke this API successfully.

##### Parameters

in	<i>callback</i>	Optional callback pointer to get the response of the manager initialization.
in	<i>oprType</i>	Operation type <a href="#">telux::common::ProcType</a> . Local operation type fetches the thermal zones information where the application is running. Remote operation type fetches the thermal zones information of modem if the application is running on external application processor(EAP) and vice versa.

**Returns**

Pointer of [IThermalManager](#) object.

**4.33.1.1.1.3** `virtual std::shared_ptr<IThermalShutdownManager> telux::therm::ThermalFactory::get←  
ThermalShutdownManager ( telux::common::InitResponseCb callback = nullptr )  
[pure virtual]`

Get thermal shutdown manager instance to control automatic thermal shutdown and get relevant notifications

On platforms with Access control enabled, Caller needs to have TELUX\_THERM\_SHUTDOWN\_CTRL permission to invoke this API successfully.

**Parameters**

in	<i>callback</i>	Optional callback pointer to get the response of the manager initialization.
----	-----------------	--

**Returns**

Pointer of [IThermalShutdownManager](#) object.

**4.33.1.2 class telux::therm::IThermalListener**

Listener class for getting notifications when thermal service status changes. The client needs to implement these methods as briefly as possible and avoid blocking calls in it. The methods in this class can be invoked from multiple different threads. Client needs to make sure that the implementation is thread-safe.

**Public member functions**

- virtual [~IThermalListener](#) ()
- virtual void [onCoolingDeviceLevelChange](#) (std::shared\_ptr< [ICoolingDevice](#) > coolingDevice)
- virtual void [onTripEvent](#) (std::shared\_ptr< [ITripPoint](#) > tripPoint, [TripEvent](#) tripEvent)

**4.33.1.2.1 Constructors and Destructors**

**4.33.1.2.1.1** `virtual telux::therm::IThermalListener::~~IThermalListener ( ) [virtual]`

Destructor of [IThermalListener](#)

**4.33.1.2.2 Member Function Documentation**

**4.33.1.2.2.1** `virtual void telux::therm::IThermalListener::onCoolingDeviceLevelChange ( std::shared_←  
ptr< ICoolingDevice > coolingDevice ) [virtual]`

This function is called at the time of cooling device level update. On platforms with Access control enabled, the client needs to have TELUX\_THERM\_DATA\_READ permission to receive this event.



**Parameters**

in	<i>coolingDevice</i>	- vector of cooling device for which the level has been updated.
----	----------------------	--

#### 4.33.1.2.2.2 virtual void telux::therm::IThermalListener::onTripEvent ( std::shared\_ptr< ITripPoint > tripPoint, TripEvent tripEvent ) [virtual]

This function is called at the time of trip event occurs. On platforms with Access control enabled, the client needs to have TELUX\_THERM\_DATA\_READ permission to receive this event.

**Parameters**

in	<i>tripInfo</i>	- Vector of the trip point for which trip event has been occurred.
in	<i>tripEvent</i>	- Indicates trip event. • NONE • CROSSED_UNDER • CROSSED_OVER

#### 4.33.1.3 struct telux::therm::BoundCoolingDevice

Defines the trip points to which cooling device is bound.

**Data fields**

Type	Field	Description
int	cooling↔ DeviceId	Cooling device Id associated with trip points
vector< shared_ptr< <a href="#">ITripPoint</a> > >	bindingInfo	List of trippoints bound to the cooling device

#### 4.33.1.4 class telux::therm::IThermalManager

[IThermalManager](#) provides interface to get thermal zone and cooling device information.

**Public member functions**

- virtual [telux::common::ServiceStatus](#) getServiceStatus ()=0
- virtual [telux::common::Status](#) registerListener (std::weak\_ptr< [IThermalListener](#) > listener, [ThermalNotificationMask](#) mask=0xFFFF)=0
- virtual [telux::common::Status](#) deregisterListener (std::weak\_ptr< [IThermalListener](#) > listener, [ThermalNotificationMask](#) mask=0xFFFF)=0
- virtual std::vector< std::shared\_ptr< [IThermalZone](#) > > getThermalZones ()=0
- virtual std::vector< std::shared\_ptr< [ICoolingDevice](#) > > getCoolingDevices ()=0
- virtual std::shared\_ptr< [IThermalZone](#) > getThermalZone (int thermalZoneId)=0

- virtual std::shared\_ptr< [ICoolingDevice](#) > [getCoolingDevice](#) (int coolingDeviceId)=0
- virtual [~IThermalManager](#) ()

#### 4.33.1.4.1 Constructors and Destructors

4.33.1.4.1.1 virtual [telux::therm::IThermalManager::~IThermalManager](#) ( ) [[virtual](#)]

Destructor of [IThermalManager](#)

#### 4.33.1.4.2 Member Function Documentation

4.33.1.4.2.1 virtual [telux::common::ServiceStatus](#) [telux::therm::IThermalManager::getServiceStatus](#) ( ) [[pure virtual](#)]

This status indicates whether the object is in a usable state.

##### Returns

[telux::common::ServiceStatus](#)

4.33.1.4.2.2 virtual [telux::common::Status](#) [telux::therm::IThermalManager::registerListener](#) ( [std::weak\\_ptr](#)< [IThermalListener](#) > *listener*, [ThermalNotificationMask](#) *mask = 0xFFFF* ) [[pure virtual](#)]

Registers the listener for Thermal Manager indications.

##### Parameters

in	<i>listener</i>	- pointer to implemented listener.
in	<i>mask</i>	- Bit mask representing a set of notifications that needs to be registered - <a href="#">ThermalNotificationType</a> Notifications under <a href="#">I&lt;-ThermalListener</a> that are not listed in <a href="#">ThermalNotificationType</a> would always be registered by default when this API is invoked. In the absence of this optional parameter, all the notifications will be registered. Bits that are not set in the mask are ignored and do not have any effect on registration or deregistration. To deregister, the API <a href="#">deregisterListener</a> should be used. For Example: API invoked with mask: 0x0001 enables onTripEvent notification, next invocation with mask: 0x0002 enables onCoolingDeviceLevelUpdate notification and previous registration for onTripEvent remains intact.

##### Returns

status of the registration request.

**4.33.1.4.2.3** `virtual telux::common::Status telux::therm::IThermalManager::deregisterListener ( std::weak_ptr< IThermalListener > listener, ThermalNotificationMask mask = 0xFFFF ) [pure virtual]`

Deregisters the previously registered listener.

#### Parameters

in	<i>listener</i>	- pointer to registered listener that needs to be removed.
in	<i>mask</i>	- Bit mask that denotes a set of notifications that needs to be de-registered - <a href="#">ThermalNotificationType</a> Notifications under <a href="#">IThermalListener</a> that are not listed in <a href="#">ThermalNotificationType</a> would not be de-registered by default. If the client does not specifies mask or sets all the bits, this API de-registers all the notifications. Bits that are not set in the mask are ignored and do not have any effect on registration or deregistration, To register, the API <a href="#">registerListener</a> should be used. For Example: API invoked with mask: 0x0001 disables onTripEvent notification, next invocation with mask: 0x0002 disables onCoolingDeviceLevelUpdate notification. mask: 0x0000 is invalid options and API invoked with mask 0x0000 will be ignored.

#### Returns

status of the deregistration request.

**4.33.1.4.2.4** `virtual std::vector<std::shared_ptr<IThermalZone> > telux::therm::IThermalManager↔::getThermalZones ( ) [pure virtual]`

Retrieves the list of thermal zone info like type, temperature and trip points.

#### Returns

List of thermal zones.

**4.33.1.4.2.5** `virtual std::vector<std::shared_ptr<ICoolingDevice> > telux::therm::IThermalManager↔::getCoolingDevices ( ) [pure virtual]`

Retrieves the list of thermal cooling device info like type, maximum throttle state and currently requested throttle state.

#### Returns

List of cooling devices.

**4.33.1.4.2.6** `virtual std::shared_ptr<IThermalZone> telux::therm::IThermalManager::getThermalZone ( int thermalZoneId ) [pure virtual]`

Retrieves the thermal zone details like temperature, type and trip point info for the given thermal zone identifier.

#### Parameters

in	<i>thermalZoneId</i>	Thermal zone identifier
----	----------------------	-------------------------

#### Returns

Pointer to thermal zone.

**4.33.1.4.2.7** `virtual std::shared_ptr<ICoolingDevice> telux::therm::IThermalManager::getCoolingDevice ( int coolingDeviceId ) [pure virtual]`

Retrieves the cooling device details like type of the device, maximum cooling level and current cooling level for the given cooling device identifier.

#### Parameters

in	<i>coolingDeviceId</i>	Cooling device identifier
----	------------------------	---------------------------

#### Returns

Pointer to cooling device.

### 4.33.1.5 class telux::therm::ITripPoint

[ITripPoint](#) provides interface to get trip point type, trip point temperature and hysteresis value for that trip point.

#### Public member functions

- virtual [TripType](#) `getType () const =0`
- virtual int `getThresholdTemp () const =0`
- virtual int `getHysteresis () const =0`
- virtual int `getTripId () const =0`
- virtual int `getTZoneId () const =0`
- virtual bool `operator==(const ITripPoint &rHs) const =0`
- virtual `~ITripPoint ()`

### 4.33.1.5.1 Constructors and Destructors

#### 4.33.1.5.1.1 virtual telux::therm::ITripPoint::~~ITripPoint ( ) [virtual]

Destructor of [ITripPoint](#)

### 4.33.1.5.2 Member Function Documentation

#### 4.33.1.5.2.1 virtual TripType telux::therm::ITripPoint::getType ( ) const [pure virtual]

Retrieves trip point type.

##### Returns

Type of trip point if available else return UNKNOWN.

- [TripType](#)

#### 4.33.1.5.2.2 virtual int telux::therm::ITripPoint::getThresholdTemp ( ) const [pure virtual]

Retrieves the temperature above which certain trip point will be fired.

- Units: MilliDegree Celsius

##### Returns

Threshold temperature

#### 4.33.1.5.2.3 virtual int telux::therm::ITripPoint::getHysteresis ( ) const [pure virtual]

Retrieves hysteresis value that is the difference between current temperature of the device and the temperature above which certain trip point will be fired. Units: MilliDegree Celsius

##### Returns

Hysteresis value

#### 4.33.1.5.2.4 virtual int telux::therm::ITripPoint::getTripld ( ) const [pure virtual]

Retrieves the identifier for trip point.

##### Returns

Identifier for trip point

#### 4.33.1.5.2.5 `virtual int telux::therm::ITripPoint::getTZoneld ( ) const [pure virtual]`

Retrieves associated tzone id for a trip point.

##### Returns

Identifier for thermal zone

#### 4.33.1.5.2.6 `virtual bool telux::therm::ITripPoint::operator==( const ITripPoint & rHs ) const [pure virtual]`

Operator for compare two trip points

##### Returns

result of two trip points whether equal or not equal.

### 4.33.1.6 `class telux::therm::IThermalZone`

[IThermalZone](#) provides interface to get type of the sensor, the current temperature reading, trip points and the cooling devices binded etc.

#### Public member functions

- virtual int [getId](#) () const =0
- virtual std::string [getDescription](#) () const =0
- virtual int [getCurrentTemp](#) () const =0
- virtual int [getPassiveTemp](#) () const =0
- virtual std::vector< std::shared\_ptr< [ITripPoint](#) > > [getTripPoints](#) () const =0
- virtual std::vector< [BoundCoolingDevice](#) > [getBoundCoolingDevices](#) () const =0
- virtual [~IThermalZone](#) ()

#### 4.33.1.6.1 Constructors and Destructors

##### 4.33.1.6.1.1 `virtual telux::therm::IThermalZone::~~IThermalZone ( ) [virtual]`

Destructor of [IThermalZone](#)

#### 4.33.1.6.2 Member Function Documentation

**4.33.1.6.2.1 virtual int telux::therm::IThermalZone::getId ( ) const [pure virtual]**

Retrieves the identifier for thermal zone.

**Returns**

Identifier for thermal zone

**4.33.1.6.2.2 virtual std::string telux::therm::IThermalZone::getDescription ( ) const [pure virtual]**

Retrieves the type of sensor.

**Returns**

Sensor type

**4.33.1.6.2.3 virtual int telux::therm::IThermalZone::getCurrentTemp ( ) const [pure virtual]**

Retrieves the current temperature of the device. Units: MilliDegree Celsius

**Returns**

Current temperature

**4.33.1.6.2.4 virtual int telux::therm::IThermalZone::getPassiveTemp ( ) const [pure virtual]**

Retrieves the temperature of passive trip point for the zone. Default value is 0. Valid values: 0 (disabled) or greater than 1000 (enabled), Units: MilliDegree Celsius

**Returns**

Temperature of passive trip point

**4.33.1.6.2.5 virtual std::vector<std::shared\_ptr<ITripPoint> > telux::therm::IThermalZone::getTripPoints ( ) const [pure virtual]**

Retrieves trip point information like trip type, trip temperature and hysteresis.

**Returns**

Trip point info list

**4.33.1.6.2.6** `virtual std::vector<BoundCoolingDevice> telux::therm::IThermalZone::getBoundCoolingDevices ( ) const [pure virtual]`

Retrieves the list of cooling device and the associated trip points bound to cooling device in given thermal zone.

#### Returns

List of bound cooling device for the given thermal zone.

### 4.33.1.7 class telux::therm::ICoolingDevice

[ICoolingDevice](#) provides interface to get type of the cooling device, the maximum throttle state and the currently requested throttle state of the cooling device.

#### Public member functions

- virtual int [getId](#) () const =0
- virtual std::string [getDescription](#) () const =0
- virtual int [getMaxCoolingLevel](#) () const =0
- virtual int [getCurrentCoolingLevel](#) () const =0
- virtual [~ICoolingDevice](#) ()

#### 4.33.1.7.1 Constructors and Destructors

**4.33.1.7.1.1** `virtual telux::therm::ICoolingDevice::~~ICoolingDevice ( ) [virtual]`

Destructor of [ICoolingDevice](#)

#### 4.33.1.7.2 Member Function Documentation

**4.33.1.7.2.1** `virtual int telux::therm::ICoolingDevice::getId ( ) const [pure virtual]`

Retrieves the identifier of the thermal cooling device.

#### Returns

Cooling device identifier



**4.33.1.7.2.2** `virtual std::string telux::therm::ICoolingDevice::getDescription ( ) const [pure virtual]`

Retrieves the type of the cooling device.

#### Returns

Cooling device type

**4.33.1.7.2.3** `virtual int telux::therm::ICoolingDevice::getMaxCoolingLevel ( ) const [pure virtual]`

Retrieves the maximum cooling level of the cooling device.

#### Returns

Maximum cooling level of the thermal cooling device

**4.33.1.7.2.4** `virtual int telux::therm::ICoolingDevice::getCurrentCoolingLevel ( ) const [pure virtual]`

Retrieves the current cooling level of the cooling device. This value can be between 0 and max cooling level. Max cooling level is different for different cooling devices like fan, processor etc.

#### Returns

Current cooling level of the thermal cooling device

## 4.33.2 Enumeration Type Documentation

**4.33.2.1** `enum telux::therm::AutoShutdownMode [strong]`

Defines the status of automatic thermal shutdown

#### Enumerator

**UNKNOWN** Automatic thermal shutdown status is unknown

**ENABLE** Automatic thermal shutdown is enabled

**DISABLE** Automatic thermal shutdown is disabled

**4.33.2.2** `enum telux::therm::TripType [strong]`

Defines the type of trip points, it can be one of the values for ACPI (Advanced Configuration and Power Interface) thermal zone

#### Enumerator

**UNKNOWN** Trip type is unknown

**CRITICAL** Trip point at which system shuts down

**HOT** Trip point to notify emergency

**PASSIVE** Trip point at which kernel lowers the CPU's frequency and throttle the processor down

**ACTIVE** Trip point at which processor fan turns on

**CONFIGURABLE\_HIGH** Triggering threshold at which mitigation starts. This type is added to support legacy targets

**CONFIGURABLE\_LOW** Clearing threshold at which mitigation stops. This type is added to support legacy targets

#### 4.33.2.3 enum telux::therm::TripEvent [strong]

Defines the event of trip.

##### Enumerator

**NONE** Trip event is none

**CROSSED\_UNDER** This event will be triggered when the temperature decreases and crosses below the configured trip minus hysteresis temp. This event will not be triggered again, if the temperature remains below the trip temperature. For Example: Below scenario considered as CROSSED\_UNDER. Prev temp: 27000 milli degree Celsius, Trip temp: 25000 milli degree Celsius, Hyst: 5000 milli degree Celsius, Curr Temp: 19000 milli degree Celsius, Below scenario will not generate CROSSED\_UNDER event again. Prev temp: 19000 milli degree Celsius, Trip temp: 25000 milli degree Celsius, Hyst: 5000 milli degree Celsius, Curr Temp: 18000 milli degree Celsius / 22000 milli degree Celsius

**CROSSED\_OVER** This event will be triggered when the temperature increases and crosses over the configured trip temperature. This event will not be triggered again, if the temperature remains over the trip temperature. For Example: Below scenario considered as CROSSED\_OVER. Prev temp: 24000 milli degree Celsius, Trip temp: 25000 milli degree Celsius, Curr Temp: 26000 milli degree Celsius, Below scenario will not generate CROSSED\_OVER event again. Prev temp: 26000 milli degree Celsius, Trip temp: 25000 milli degree Celsius, Curr Temp: 27000 milli degree Celsius

#### 4.33.2.4 enum telux::therm::ThermalNotificationType

Defines some of the notifications supported by [IThermalListener](#) which can be dynamically disabled/enabled.

##### Enumerator

**TNT\_TRIP\_UPDATE**

**TNT\_CDEV\_LEVEL\_UPDATE**

**TNT\_MAX\_TYPE**

### 4.33.3 Variable Documentation

#### 4.33.3.1 const uint32\_t telux::therm::DEFAULT\_TIMEOUT = 30

Default time out (in seconds) for thermal auto-shutdown service to re-enable thermal auto-shutdown.

## 4.34 Thermal Shutdown Management

This section contains APIs related to Thermal Shutdown Management such as set/get thermal auto-shutdown mode, receive notifications on every auto-shutdown update.

### 4.34.1 Data Structure Documentation

#### 4.34.1.1 class `telux::therm::IThermalShutdownListener`

Listener class for getting notifications when automatic thermal shutdown mode is enabled/ disabled or will be enabled imminently. The client needs to implement these methods as briefly as possible and avoid blocking calls in it. The methods in this class can be invoked from multiple different threads. Client needs to make sure that the implementation is thread-safe.

##### Public member functions

- virtual void `onShutdownEnabled ()`
- virtual void `onShutdownDisabled ()`
- virtual void `onImminentShutdownEnablement (uint32_t imminentDuration)`
- virtual `~IThermalShutdownListener ()`

##### 4.34.1.1.1 Constructors and Destructors

**4.34.1.1.1.1** virtual `telux::therm::IThermalShutdownListener::~~IThermalShutdownListener ( )`  
[virtual]

Destructor of `IThermalShutdownListener`

##### 4.34.1.1.2 Member Function Documentation

**4.34.1.1.2.1** virtual void `telux::therm::IThermalShutdownListener::onShutdownEnabled ( )`  
[virtual]

This function is called when the automatic shutdown mode changes to ENABLE

**4.34.1.1.2.2** virtual void `telux::therm::IThermalShutdownListener::onShutdownDisabled ( )`  
[virtual]

This function is called when the automatic shutdown mode changes to DISABLE

**4.34.1.1.2.3** virtual void `telux::therm::IThermalShutdownListener::onImminentShutdownEnablement ( uint32_t imminentDuration )` [virtual]

This function is called when the automatic shutdown mode is about to change to ENABLE. Clients that want to keep the shutdown mode disabled, needs to set it accordingly with in the `imminentDuration` time. If disabled successfully within `imminentDuration` time, the system timer for auto-enablement will be reset.

**Parameters**

in	<i>imminentDuration</i>	Time elapsed(in seconds) for the shutdown mode to be enabled
----	-------------------------	--

**4.34.1.2 class telux::therm::IThermalShutdownManager**

[IThermalShutdownManager](#) class provides interface to enable/disable automatic thermal shutdown. Additionally it facilitates to register for notifications when the automatic shutdown mode changes.

**Public member functions**

- virtual bool [isReady](#) ()=0
- virtual [telux::common::ServiceStatus getServiceStatus](#) ()=0
- virtual std::future< bool > [onReady](#) ()=0
- virtual [telux::common::Status registerListener](#) (std::weak\_ptr< [IThermalShutdownListener](#) > listener)=0
- virtual [telux::common::Status deregisterListener](#) (std::weak\_ptr< [IThermalShutdownListener](#) > listener)=0
- virtual [telux::common::Status setAutoShutdownMode](#) ([AutoShutdownMode](#) mode, [telux::common::ResponseCallback](#) callback=nullptr, uint32\_t timeout=[DEFAULT\\_TIMEOUT](#))=0
- virtual [telux::common::Status getAutoShutdownMode](#) ([GetAutoShutdownModeResponseCb](#) callback)=0
- virtual [~IThermalShutdownManager](#) ()

**4.34.1.2.1 Constructors and Destructors**

**4.34.1.2.1.1** virtual [telux::therm::IThermalShutdownManager::~~IThermalShutdownManager](#) ( )  
[[virtual](#)]

Destructor of [IThermalShutdownManager](#)

**4.34.1.2.2 Member Function Documentation**

**4.34.1.2.2.1** virtual bool [telux::therm::IThermalShutdownManager::isReady](#) ( ) [[pure virtual](#)]

Checks the status of thermal shutdown management service and if the other APIs are ready for use and returns the result.

**Returns**

True if the services are ready otherwise false.

**Deprecated**

use [getServiceStatus\(\)](#)

**4.34.1.2.2.2** `virtual telux::common::ServiceStatus telux::therm::IThermalShutdownManager::get↔  
ServiceStatus ( ) [pure virtual]`

This status indicates whether the object is in a usable state.

#### Returns

[telux::common::ServiceStatus](#)

**4.34.1.2.2.3** `virtual std::future<bool> telux::therm::IThermalShutdownManager::onReady ( ) [pure  
virtual]`

Wait for thermal shutdown management service to be ready.

#### Returns

A future that caller can wait on to be notified when thermal shutdown management service is ready.

#### Deprecated

The callback mechanism introduced in the [ThermalFactory::getThermalShutdownManager](#) with initialization callback along with [getServiceStatus](#) API will provide the similar mechanism as [onReady](#) and [isReady](#). This API will soon be removed from further releases.

**4.34.1.2.2.4** `virtual telux::common::Status telux::therm::IThermalShutdownManager::registerListener (   
std::weak_ptr< IThermalShutdownListener > listener ) [pure virtual]`

Register a listener for updates on automatic shutdown mode changes

#### Parameters

in	<i>listener</i>	Pointer of <a href="#">IThermalShutdownListener</a> object that processes the notification
----	-----------------	--

#### Returns

Status of registerListener i.e success or suitable status code.

**4.34.1.2.2.5** `virtual telux::common::Status telux::therm::IThermalShutdownManager::deregisterListener  
( std::weak_ptr< IThermalShutdownListener > listener ) [pure virtual]`

Remove a previously registered listener.

#### Parameters

in	<i>listener</i>	Previously registered <a href="#">IThermalShutdownListener</a> that needs to be removed
----	-----------------	---

**Returns**

Status of deregisterListener, success or suitable status code

**4.34.1.2.2.6** `virtual telux::common::Status telux::therm::IThermalShutdownManager::setAuto↔  
ShutdownMode ( AutoShutdownMode mode, telux::common::ResponseCallback callback  
= nullptr, uint32_t timeout = DEFAULT_TIMEOUT ) [pure virtual]`

Set automatic thermal shutdown mode. When set to DISABLE mode successfully, it remains in DISABLE mode briefly and automatically changes to ENABLE mode after notifying the clients.

**Parameters**

in	<i>mode</i>	desired AutoShutdownMode to be set
in	<i>callback</i>	Optional callback to get the response of the command
in	<i>timeout</i>	Optional timeout(in seconds) for which auto-shutdown remains disabled.

**Returns**

Status of setAutoShutdownMode i.e. success or suitable status code.

**4.34.1.2.2.7** `virtual telux::common::Status telux::therm::IThermalShutdownManager::get↔  
AutoShutdownMode ( GetAutoShutdownModeResponseCb callback ) [pure  
virtual]`

Get automatic thermal shutdown mode.

**Parameters**

in	<i>callback</i>	GetAutoShutdownModeResponseCb to get response of the request
----	-----------------	--

**Returns**

Status of getAutoShutdownMode i.e. success or suitable status code.

## 4.35 Power

- [TCU Activity Manager](#)

This section contains APIs related to power.

## 4.36 TCU Activity Manager

This section contains APIs related to TCU activity state management.

### 4.36.1 Data Structure Documentation

#### 4.36.1.1 class telux::power::PowerFactory

[PowerFactory](#) allows creation of TCU-activity manager instance.

##### Public member functions

- virtual `std::shared_ptr< ITcuActivityManager > getTcuActivityManager (ClientInstanceConfig config, telux::common::InitResponseCb callback=nullptr)=0`
- virtual `std::shared_ptr< ITcuActivityManager > getTcuActivityManager (ClientType client←Type=ClientType::SLAVE, common::ProcType procType=common::ProcType::LOCAL_PROC, telux::common::InitResponseCb callback=nullptr)=0`

##### Static Public Member Functions

- static `PowerFactory & getInstance ()`

#### 4.36.1.1.1 Member Function Documentation

##### 4.36.1.1.1.1 static PowerFactory& telux::power::PowerFactory::getInstance ( ) [static]

API to get the factory instance for TCU-activity management

##### 4.36.1.1.1.2 virtual std::shared\_ptr<ITcuActivityManager> telux::power::PowerFactory::getTcu←ActivityManager ( ClientInstanceConfig config, telux::common::InitResponseCb callback = nullptr ) [pure virtual]

Gets the TCU-activity manager instance.

##### Parameters

in	<i>config</i>	TCU-activity manager configuration
in	<i>callback</i>	Optional callback pointer to get the response of the manager initialization.

##### Returns

Pointer to [ITcuActivityManager](#) object.

##### Note

This API is recommended for both hypervisor and non-hypervisor based systems.



```
4.36.1.1.1.3 virtual std::shared_ptr<ITcuActivityManager> telux::power::PowerFactory::getTcuActivityManager ( ClientType clientType = ClientType::SLAVE, common::ProcType procType = common::ProcType::LOCAL_PROC, telux::common::InitResponseCb callback = nullptr ) [pure virtual]
```

Gets the TCU-activity manager instance.

#### Parameters

in	<i>clientType</i>	Type of the client that is going to access <a href="#">ITcuActivityManager</a> APIs <a href="#">ClientType</a>
in	<i>procType</i>	Required processor type on which the operations will be performed <a href="#">telux::common::ProcType</a> <a href="#">telux::common::ProcType::REMOTE_PROC</a> is not supported
in	<i>callback</i>	Optional callback pointer to get the response of the manager initialization.

#### Returns

Pointer of [ITcuActivityManager](#) object.

#### Note

This API cannot be used on virtual machines or on systems with hypervisor. The alternative API [PowerFactory::getTcuActivityManager\( ClientInstanceConfig config,telux::common::InitResponseCb callback\)](#) should be used.

#### Deprecated

Use [PowerFactory::getTcuActivityManager\(ClientInstanceConfig config, telux::common::InitResponseCb callback\)](#) API instead

Type	Field	Description
------	-------	-------------

#### 4.36.1.2 struct telux::power::ClientInstanceConfig

TCU-activity Manager configuration

##### Data fields

Type	Field	Description
<a href="#">ClientType</a>	clientType	Type of the client that is going to access <a href="#">ITcuActivityManager</a> APIs <a href="#">ClientType</a> . There will be a single <a href="#">ClientType::MASTER</a> across all available machines.
string	clientName	Identifies the client that is retrieving an instance of the <a href="#">TcuActivityManager</a> . This is a mandatory field and it needs to be unique across all <a href="#">TcuActivityManager</a> clients across all machines in the system. To make it unique, one example could be <code>machineName_ProcessName_ProcessId</code> . This field will be used to provide a list of client names to the master via <a href="#">ITcuActivityListener::onSlaveAckStatusUpdate</a> in case any slave client does not acknowledge or provide a nack via <a href="#">ITcuActivityManager::sendActivityStateAck</a> for state transition triggered by the master via <a href="#">ITcuActivityManager::setActivityState</a>
string	machineName	This field is unnecessary for clients of type <a href="#">ClientType::MASTER</a> . For clients of type <a href="#">ClientType::SLAVE</a> this field specifies whether the slave is interested in the power state transition of all machines or only the machine where the slave is running. For interest in all machines, this field should be assigned <a href="#">ALL_MACHINES</a> and for local machine assign <a href="#">LOCAL_MACHINE</a> . For slaves, if this field is not provided, then the local machine name will be used as the default.

#### 4.36.1.3 class telux::power::ITcuActivityListener

Listener class for getting notifications related to TCU-activity state and also the updates related to TCU-activity service status. The client needs to implement these methods as briefly as possible and avoid blocking calls in it. The methods in this class can be invoked from multiple different threads. Client needs to make sure that the implementation is thread-safe.

##### Public member functions

- virtual void [onTcuActivityStateUpdate](#) ([TcuActivityState](#) state, std::string machineName)
- virtual void [onSlaveAckStatusUpdate](#) (const [telux::common::Status](#) status, const std::string machineName, const std::vector< [ClientInfo](#) > unresponsiveClients, const std::vector< [ClientInfo](#) > nackResponseClients)
- virtual void [onMachineUpdate](#) (const std::string machineName, const [MachineEvent](#) machineEvent)
- virtual void [onSlaveAckStatusUpdate](#) ([telux::common::Status](#) status)
- virtual void [onTcuActivityStateUpdate](#) ([TcuActivityState](#) state)
- virtual [~ITcuActivityListener](#) ()

### 4.36.1.3.1 Constructors and Destructors

#### 4.36.1.3.1.1 virtual telux::power::ITcuActivityListener::~~ITcuActivityListener ( ) [virtual]

Destructor of [ITcuActivityListener](#)

### 4.36.1.3.2 Member Function Documentation

#### 4.36.1.3.2.1 virtual void telux::power::ITcuActivityListener::onTcuActivityStateUpdate ( TcuActivity↔ State *state*, std::string *machineName* ) [virtual]

This function is called when the TCU activity state of the machine(that the client is registered for) is going to change. When the master triggers state change of a machine using [ITcuActivityManager::setActivityState](#), the slave clients interested in that machine will receive this notification. This notification will not be received by the Master. State change of [ALL\\_MACHINES](#) via [ITcuActivityManager::setActivityState](#) could lead to an individual machine's state change, resulting in a notification to clients of all machines. Slave clients who got this indication must acknowledge it with [ITcuActivityManager::sendActivityStateAck](#).

#### Parameters

in	<i>state</i>	TCU-activity state that the machine is about to enter
in	<i>machineName</i>	Machine name that is undergoing the state change. Assigned <a href="#">ALL_MACHINES</a> for a global state change and <a href="#">LOCAL_MACHINE</a> for a local state change.

#### 4.36.1.3.2.2 virtual void telux::power::ITcuActivityListener::onSlaveAckStatusUpdate ( const telux::common::Status *status*, const std::string *machineName*, const std::vector< ClientInfo > *unresponsiveClients*, const std::vector< ClientInfo > *nackResponseClients* ) [virtual]

Informs the master with the consolidated acknowledgement from all slave clients for the state change previously triggered by the master client.

This API will be invoked only for the MASTER client.

On platforms with access control enabled, the client needs to have `TELUX_POWER_CONTROL_STATE` permission for this listener API to be invoked.

#### Parameters

in	<i>status</i>	This is the status of acknowledgements corresponding to a particular request. If any slave doesn't acknowledge within the configured timeout, then <code>Status::EXPIRED</code> is reported. If any slave sends a negative acknowledgement, then <code>Status::NOTREADY</code> is reported. If both types of acknowledgement errors exist, then the status code corresponding to most number of clients is reported.
----	---------------	--

in	<i>machineName</i>	Machine name that is undergoing the state change. Assigned <a href="#">ALL_MACHINES</a> for a global state change and <a href="#">LOCAL_MACHINE</a> for a local state change.
in	<i>unresponsiveClients</i>	List of client and respective machine names that have not responded via <code>sendActivityStateAck</code> for state transitions of suspend or shutdown triggered by the master via <a href="#">ITcuActivityManager::setActivityState</a> .
in	<i>nackResponseClients</i>	List of client and respective machine name who responded with <a href="#">TcuActivityStateChangeResponse::NACK</a> for state transitions of suspend or shutdown triggered by the master via <a href="#">ITcuActivityManager::setActivityState</a> .

**Note**

This API is recommended for systems with and without hypervisor.

#### 4.36.1.3.2.3 `virtual void telux::power::ITcuActivityListener::onMachineUpdate ( const std::string machineName, const MachineEvent machineEvent ) [virtual]`

This API will be invoked if any machine availability changes with respect to power management.

User can use [ITcuActivityManager::getAllMachineNames\(\)](#) to get all updated available machines. It will be useful for the master client if they are interested in setting the TCUActivityState of a specific machine [ITcuActivityManager::setActivityState\(\)](#).

This API is meant for clients that have instantiated the [ITcuActivityManager](#) instance using [ClientType::MASTER](#)

**Parameters**

in	<i>machineName</i>	Name of the machine
in	<i>machineEvent</i>	Machine event ( <a href="#">MachineEvent</a> )

#### 4.36.1.3.2.4 `virtual void telux::power::ITcuActivityListener::onSlaveAckStatusUpdate ( telux::common::Status status ) [virtual]`

This function is called with the overall acknowledgement status from all the SLAVE clients, for state change triggered previously by MASTER client.

This API will be invoked only for the MASTER client. If at least one SLAVE client does not acknowledge within the configured timeout, then `Status::EXPIRED` would be reported.

On platforms with Access control enabled, the client needs to have `TELUX_POWER_CONTROL_STATE` permission for this listener API to be invoked.

**Parameters**

in	<i>status</i>	Status of the SLAVE clients' acknowledgements
----	---------------	---

**Note**

This API should not be used on virtual machines or on systems with hypervisor. The alternative API [onSlaveAckStatusUpdate](#)([telux::common::Status](#) status, [std::string](#) machineName, [std::vector<std::string>](#) unresponsiveClients, [std::vector<std::string>](#) nackResponseClients) should be used.

**Deprecated**

Use [onSlaveAckStatusUpdate](#)([const telux::common::Status](#) status, [const std::string](#) machineName, [const std::vector<std::pair<std::string, std::string>>](#) unresponsiveClients, [const std::vector<std::pair<std::string, std::string>>](#) nackResponseClients) API instead

#### 4.36.1.3.2.5 **virtual void telux::power::ITcuActivityListener::onTcuActivityStateUpdate ( TcuActivity↔ State state ) [virtual]**

This function is called when the TCU-activity state is going to change.

**Parameters**

in	<i>state</i>	TCU-activity state that system is about to enter
----	--------------	--

**Deprecated**

Use [onTcuActivityStateUpdate](#)([TcuActivityState](#) state, [bool](#) isGlobalStateChange) API instead

#### 4.36.1.4 **class telux::power::ITcuActivityManager**

[ITcuActivityManager](#) provides interface to register and de-register listeners to get TCU-activity state updates. And also API to initiate TCU-activity state transition.

An application can get the appropriate TCU-activity manager (i.e. [ClientType::SLAVE](#) or [ClientType::MASTER](#)) object from the power factory. The TCU-activity manager configured as the [ClientType::MASTER](#) is responsible for triggering state transitions. TCU-activity manager configured as a [ClientType::SLAVE](#) is responsible for listening to state change indications and acknowledging when it performs necessary tasks and prepares for the state transition. A machine in this power management framework represents an application processor subsystem or a host/guest virtual machine on hypervisor based platforms.

- Only one [ClientType::MASTER](#) is allowed in the system, and currently we only support allowing the [ClientType::MASTER](#) on the primary/host machine and not on the guest virtual machine.
- It is expected that all processes interested in a TCU-activity state change should register as [ClientType::SLAVE](#).
- When the [ClientType::MASTER](#) changes the TCU-activate state, [ClientType::SLAVEs](#) connected to the impacted machine are notified.
- [ClientType::MASTER](#) can trigger the TCU-activity state change of a specific machine or all machines at once.
- If the [ClientType::SLAVE](#) wants to differentiate between a state change indication that is the result of

a trigger for all machines or a trigger for its specific machines, it can be detected using the machine name provided in the listener API.

- When the `ClientType::MASTER` triggers an all machines TCU-activity state change, only the machines that are not in the desired state will undergo the state transition, and the `ClientType::SLAVE`s to those machines will be notified.
- In the case of
  - `TcuActivityState::SUSPEND` or `TcuActivityState::SHUTDOWN` trigger:
    - After becoming ready for state change, all `ClientType::SLAVE` should acknowledge back.
    - The `ClientType::MASTER` will get notification about the consolidated acknowledgement status of all `ClientType::SLAVE`s.
    - On getting a successful consolidated acknowledgement from all the `ClientType::SLAVE` for the suspend trigger, the power framework allows the respective machine to suspend. On getting a successful consolidated acknowledgement from all the `ClientType::SLAVE`s for the shutdown trigger, the power framework triggers the respective machine shutdown without waiting further.
    - If the `ClientType::SLAVE` sends a NACK to indicate that it is not ready for state transition or fails to acknowledge before the configured time, then the `ClientType::MASTER` will get to know via a consolidated/slave acknowledgement status notification.
    - In such failed cases, if the `ClientType::MASTER` wants to stop the state transition considering the information in the consolidated acknowledgement, then the `ClientType::MASTER` is allowed to trigger a new TCU-activity state change, or else the state transition will proceed after the configured timeout.
  - `TcuActivityState::RESUME` trigger:
    - Power framework will prevent the respective machine from going into suspend.
    - No acknowledgement will be required from `ClientType::SLAVE` and the `ClientType::MASTER` will not be getting consolidated/slave acknowledgement as machine will be already resumed.

When the application is notified about the service being unavailable, the TCU-activity state notifications will be inactive. After the service becomes available, the existing listener registrations will be maintained.

### Public member functions

- virtual `telux::common::ServiceStatus getServiceStatus ()=0`
- virtual `telux::common::Status registerListener (std::weak_ptr< ITcuActivityListener > listener)=0`
- virtual `telux::common::Status deregisterListener (std::weak_ptr< ITcuActivityListener > listener)=0`
- virtual `telux::common::Status registerServiceStateListener (std::weak_ptr< telux::common::IServiceStatusListener > listener)=0`
- virtual `telux::common::Status deregisterServiceStateListener (std::weak_ptr< telux::common::IServiceStatusListener > listener)=0`
- virtual `telux::common::Status getMachineName (std::string &machineName)=0`
- virtual `telux::common::Status getAllMachineNames (std::vector< std::string > &machineNames)=0`
- virtual `telux::common::Status setActivityState (TcuActivityState state, std::string machineName, telux::common::ResponseCallback callback=nullptr)=0`

- virtual `TcuActivityState getActivityState ()=0`
- virtual `telux::common::Status sendActivityStateAck (StateChangeResponse ack, TcuActivityState state)=0`
- virtual `telux::common::Status setModemActivityState (TcuActivityState state)=0`
- virtual `bool isReady ()=0`
- virtual `std::future< bool > onReady ()=0`
- virtual `telux::common::Status setActivityState (TcuActivityState state, telux::common::ResponseCallback callback=nullptr)=0`
- virtual `telux::common::Status sendActivityStateAck (TcuActivityStateAck ack)=0`
- virtual `~ITcuActivityManager ()`

#### 4.36.1.4.1 Constructors and Destructors

##### 4.36.1.4.1.1 virtual `telux::power::ITcuActivityManager::~~ITcuActivityManager ( ) [virtual]`

Destructor of `ITcuActivityManager`

#### 4.36.1.4.2 Member Function Documentation

##### 4.36.1.4.2.1 virtual `telux::common::ServiceStatus telux::power::ITcuActivityManager::getServiceStatus ( ) [pure virtual]`

This status indicates whether the `ITcuActivityManager` object is in a usable state.

#### Returns

`telux::common::ServiceStatus`

##### 4.36.1.4.2.2 virtual `telux::common::Status telux::power::ITcuActivityManager::registerListener ( std::weak_ptr< ITcuActivityListener > listener ) [pure virtual]`

Register a listener for updates on TCU-activity state changes.

#### Parameters

in	<i>listener</i>	Pointer of <code>ITcuActivityListener</code> object that processes the notification
----	-----------------	---

#### Returns

Status of registerListener i.e success or suitable status code.

**4.36.1.4.2.3** `virtual telux::common::Status telux::power::ITcuActivityManager::deregisterListener ( std::weak_ptr< ITcuActivityListener > listener ) [pure virtual]`

Remove a previously registered listener.

#### Parameters

in	<i>listener</i>	Previously registered <a href="#">ITcuActivityListener</a> that needs to be removed
----	-----------------	---

#### Returns

Status of deregisterListener, success or suitable status code

**4.36.1.4.2.4** `virtual telux::common::Status telux::power::ITcuActivityManager::registerServiceStateListener ( std::weak_ptr< telux::common::IServiceStatusListener > listener ) [pure virtual]`

Register a listener for updates on TCU-activity management service status.

#### Parameters

in	<i>listener</i>	Pointer of IServiceStatusListener object that processes the notification
----	-----------------	--

#### Returns

Status of registerServiceStateListener i.e success or suitable status code.

**4.36.1.4.2.5** `virtual telux::common::Status telux::power::ITcuActivityManager::deregisterServiceStateListener ( std::weak_ptr< telux::common::IServiceStatusListener > listener ) [pure virtual]`

Remove a previously registered listener for service status updates.

#### Parameters

in	<i>listener</i>	Previously registered IServiceStatusListener that needs to be removed
----	-----------------	---

#### Returns

Status of deregisterServiceStateListener, success or suitable status code

**4.36.1.4.2.6** `virtual telux::common::Status telux::power::ITcuActivityManager::getMachineName ( std::string & machineName ) [pure virtual]`

This API allows the caller to get the machine name where the client is running. It is intended to identify the local machine name on a platform where multiple machines are available in the power framework.



**Parameters**

out	<i>machineName</i>	Machine name where the process is running
-----	--------------------	---

**Returns**

Status of getMachineName, success or suitable status code.

#### 4.36.1.4.2.7 virtual telux::common::Status telux::power::ITcuActivityManager::getAllMachineNames ( std::vector< std::string > & *machineNames* ) [pure virtual]

Enumerates all machines in the system that are available and ready to be managed by the power framework.

This API is meant for clients that have instantiated the [ITcuActivityManager](#) instance using [ClientType::MASTER](#). If the platform has multiple machines available, knowing their names will be useful if the master is interested in individually modifying the activity state of any available machine using [setActivityState](#).

**Parameters**

out	<i>machineNames</i>	List of machine names that are available for power management.
-----	---------------------	--

**Returns**

Status of getAllMachineNames, success or suitable status code.

#### 4.36.1.4.2.8 virtual telux::common::Status telux::power::ITcuActivityManager::setActivityState ( TcuActivityState *state*, std::string *machineName*, telux::common::ResponseCallback *callback = nullptr* ) [pure virtual]

Initiates a TCU-activity state transition.

This API also initiates the relevant internal operation if the platform is configured to change the modem activity state automatically when the TCU activity state changes.

This API needs to be used cautiously, as it could change the power-state of the system and may affect other processes. For example, if a master sets the SUSPEND state, all SLAVE processes will suspend their activity, allowing the system to suspend.

This API can only be invoked by clients that have instantiated the [ITcuActivityManager](#) instance using [ClientType::MASTER](#).

Based on the final acknowledgements from all the slaves [ITcuActivityListener::onSlaveAckStatusUpdate](#),

1. If the acknowledgement status is SUCCESS, then the framework attempts to state transition(SUSPEND/SHUTDOWN) immediately on the relevant machines.
2. If the acknowledgement status is not SUCCESS, then the framework waits for a configured timeout before attempting the state transition(SUSPEND/SHUTDOWN) on the relevant machines.

On platforms with Access control enabled, Caller needs to have TELUX\_POWER\_CONTROL\_STATE permission to invoke this API successfully.

**Parameters**

in	<i>state</i>	TCU-activity state that the system is intended to enter
in	<i>machineName</i>	Machine name if the state transition is intended for the specific machine only. If assigned to ALL_MACHINES, then the state applies to the whole system.
in	<i>callback</i>	Optional callback to get the response for the TCU-activity state transition command

**Returns**

Status of setActivityState i.e. success or suitable status code.

#### 4.36.1.4.2.9 **virtual TcuActivityState telux::power::ITcuActivityManager::getActivityState ( ) [pure virtual]**

Get the current TCU-activity state.

**Returns**

TcuActivityState

#### 4.36.1.4.2.10 **virtual telux::common::Status telux::power::ITcuActivityManager::sendActivityStateAck ( StateChangeResponse *ack*, TcuActivityState *state* ) [pure virtual]**

Sends the acknowledgement after processing a TCU-activity state notification. This indicates that the client is prepared for the state transition. Only one acknowledgement should be sent per [ClientType::SLAVE](#) instance of [ITcuActivityManager](#), even if multiple listeners are registered with that instance.

All slave clients that received a state change notification via [TcuActivityListener::onTcuActivityStateUpdate](#) must acknowledge using this API.

**Parameters**

in	<i>ack</i>	Acknowledgement for a TCU-activity state notification <a href="#">StateChangeResponse</a> .
in	<i>state</i>	Represents the TCU activity state transition event corresponding to this acknowledgement.

**Returns**

Status of sendActivityStateAck i.e. success or suitable status code.

#### 4.36.1.4.2.11 **virtual telux::common::Status telux::power::ITcuActivityManager::setModemActivityState ( TcuActivityState *state* ) [pure virtual]**

Explicitly sets the modem state change.

The platform could be configured to automatically manage the modem state when setTcuActivityState is called. For example, when suspend is called, the implementation will also set the modem to suspend. In

that case, this API need not be invoked after setting the TCU state.

This API needs to be used cautiously, as it could affect WWAN functionalities.

This API is meant for clients that have instantiated the [ITcuActivityManager](#) instance using [ClientType::MASTER](#)

On platforms with Access control enabled, Caller needs to have TELUX\_POWER\_CONTROL\_STATE permission to invoke this API successfully.

#### Parameters

in	<i>state</i>	Activity state that the modem is intended to enter <a href="#">TcuActivityState</a> SUSPEND - Reduce/Throttle the modem activities RESUME - Restore the activities that were throttled earlier Any other input is considered invalid.
----	--------------	--

#### Returns

Status of setModemActivityState i.e. success or suitable status code.

#### 4.36.1.4.2.12 virtual bool telux::power::ITcuActivityManager::isReady ( ) [pure virtual]

Checks the status of TCU-activity services, if other APIs are ready for use, and returns the results.

#### Returns

True if the services are ready; otherwise, false.

#### Deprecated

Use [ITcuActivityManager::getServiceStatus\(\)](#) API.  
[telux::power::ITcuActivityManager::getServiceStatus](#)

#### 4.36.1.4.2.13 virtual std::future<bool> telux::power::ITcuActivityManager::onReady ( ) [pure virtual]

Waits for TCU-activity services to be ready.

#### Returns

A future that caller can wait on to be notified when TCU-activity services are ready.

#### Deprecated

Use InitResponseCb in [PowerFactory::getTcuActivityManager](#) instead, to get notified about subsystem readiness [telux::power::PowerFactory::getTcuActivityManager](#)

**4.36.1.4.2.14** `virtual telux::common::Status telux::power::ITcuActivityManager::setActivityState ( TcuActivityState state, telux::common::ResponseCallback callback = nullptr ) [pure virtual]`

Initiates a TCU-activity state transition. If platform is configured to change modem activity state automatically when TCU activity state is changed, this API initiates the relevant internal operation.

This API needs to be used cautiously, as it could change the power-state of the system and may affect other processes.

This API should only be invoked by a client that has instantiated the [ITcuActivityManager](#) instance using [ClientType::MASTER](#)

On platforms with access control enabled, the caller needs to have `TELUX_POWER_CONTROL_STATE` permission to invoke this API successfully.

#### Parameters

in	<i>state</i>	TCU-activity state that the system is intended to enter
in	<i>callback</i>	Optional callback to get the response for the TCU-activity state transition command

#### Returns

Status of `setActivityState` i.e. success or suitable status code.

#### Note

This API should not be used on virtual machines or on systems with hypervisor. The alternative API `setActivityState( TcuActivityState state, std::string machineName = "", telux::common::ResponseCallback callback = nullptr)` should be used.

#### Deprecated

Use `setActivityState(TcuActivityState state, std::string machineName, telux::common::ResponseCallback)` API instead

**4.36.1.4.2.15** `virtual telux::common::Status telux::power::ITcuActivityManager::sendActivityStateAck ( TcuActivityStateAck ack ) [pure virtual]`

Sends acknowledgement after processing a TCU activity state notification. This indicates that the client is prepared for state transition. Only one acknowledgement is expected from a single client process, although it may have multiple listeners.

All slave clients that received a state change notification via `TcuActivityListener::onTcuActivityStateUpdate` must acknowledge using this API.

#### Parameters

in	<i>ack</i>	Acknowledgement for a TCU-activity state notification.
----	------------	--

## Returns

Status of `sendActivityStateAck` i.e. success or suitable status code.

## Deprecated

Use [sendActivityStateAck](#)( TcuActivityState state, StateChangeResponse ack) API instead

## 4.36.2 Enumeration Type Documentation

### 4.36.2.1 enum telux::power::TcuActivityState [strong]

Defines the supported TCU-activity states that the listeners will be notified about.

#### Enumerator

**UNKNOWN** To indicate that system state information is not available  
**SUSPEND** System is going to SUSPEND state  
**RESUME** System is going to RESUME state  
**SHUTDOWN** System is going to SHUTDOWN

### 4.36.2.2 enum telux::power::StateChangeResponse [strong]

Defines the acknowledgements to TCU-activity state transition. The client process sends this response via [ITcuActivityManager::sendActivityStateAck](#) after processing the TCU-activity state change notification received via [ITcuActivityListener::onTcuActivityStateUpdate](#).

The framework does not require slave clients to respond when changing the state to [TcuActivityState::RESUME](#).

#### Enumerator

**ACK** Processed TCU-activity state change  
**NACK** Not prepared/ready for TCU-activity state change

### 4.36.2.3 enum telux::power::ClientType [strong]

Defines the type of client that would be using the [ITcuActivityManager](#) APIs. Client that just needs the TcuActivityState notifications needs to choose [ClientType::SLAVE](#). And the client that determines the TcuActivityState would choose [ClientType::MASTER](#). Only a Master client can set the TcuActivityState. In a system, there should be a single Master client.

The ClientType needs to be chosen while instantiating the [ITcuActivityManager](#), using the API [PowerFactory::getTcuActivityManager](#)

#### Enumerator

**SLAVE** Client is a slave and interested in state change notification  
**MASTER** Client makes the decision on when the TcuActivityState should change

#### 4.36.2.4 enum telux::power::MachineEvent [strong]

Defines the type of event with respect to machine availability. This only represents the availability of the machine to manage its activity state and not whether the machine itself is enabled.

[ITcuActivityListener::onMachineUpdate\(\)](#) can be used to listen to changes in machine availability.

##### Enumerator

**AVAILABLE** New machine available for power management

**UNAVAILABLE** machine unavailable for power management

#### 4.36.2.5 enum telux::power::TcuActivityStateAck [strong]

Defines the acknowledgements to TCU-activity states. The client process sends this after processing the TcuActivityState notification, indicating that it is prepared for state transition

Acknowledgement for [TcuActivityState::RESUME](#) is not required, as the state transition has already happened.

##### Deprecated

The API [ITcuActivityManager::sendActivityStateAck](#) (TcuActivityStateAck) that uses this enum is deprecated. Instead, use [ITcuActivityManager::sendActivityStateAck](#) (StateChangeResponse, TcuActivityState).

##### Enumerator

**SUSPEND\_ACK** processed [TcuActivityState::SUSPEND](#) notification

**SHUTDOWN\_ACK** processed [TcuActivityState::SHUTDOWN](#) notification

### 4.36.3 Variable Documentation

#### 4.36.3.1 const std::string telux::power::ALL\_MACHINES = "ALL\_MACHINES" [static]

This special name represents all the machines on the platform. A client could specify this name when using [ClientInstanceConfig::machineName](#) to mean all machines as opposed to a specific machine name.

#### 4.36.3.2 const std::string telux::power::LOCAL\_MACHINE = "LOCAL\_MACHINE" [static]

This special name represents the machine name where the process is running. A client could specify this name when using [ClientInstanceConfig::machineName](#) to mean local machine's name.

"LOCAL\_MACHINE" in case of a hypervisor environment specifies that the client is interested in the virtual machine the client is running on.

## 4.37 Modem Configuration

- [Modem Config](#)

This section contains APIs related to Modem config.

## 4.38 Modem Config

This section contains APIs related to Modem Config operations.

### 4.38.1 Data Structure Documentation

#### 4.38.1.1 class telux::config::ConfigFactory

[ConfigFactory](#) allows creation of config related classes.

##### Public member functions

- virtual `std::shared_ptr< IModemConfigManager > getModemConfigManager (telux::common::InitResponseCb callback=nullptr)=0`
- virtual `std::shared_ptr< IConfigManager > getConfigManager (telux::common::InitResponseCb callback=nullptr)=0`

##### Static Public Member Functions

- static `ConfigFactory & getInstance ()`

#### 4.38.1.1.1 Member Function Documentation

##### 4.38.1.1.1.1 static ConfigFactory& telux::config::ConfigFactory::getInstance ( ) [static]

Get instance of Config Factory

##### 4.38.1.1.1.2 virtual std::shared\_ptr<IModemConfigManager> telux::config::ConfigFactory::get← ModemConfigManager ( telux::common::InitResponseCb callback = nullptr ) [pure virtual]

Get instance of ModemConfig manager

On platforms with Access control enabled, Caller needs to have TELUX\_CONFIG\_MODEM\_CONFIG permission to invoke this API successfully.

##### Parameters

<code>in</code>	<code>callback</code>	Optional callback to get the response of Modem Config Manager initialization.
-----------------	-----------------------	---

##### Returns

pointer of [IModemConfigManager](#) object.



#### 4.38.1.1.1.3 virtual std::shared\_ptr<IConfigManager> telux::config::ConfigFactory::getConfigManager ( telux::common::InitResponseCb *callback* = nullptr ) [pure virtual]

Get instance of the Config manager

On platforms with Access control enabled, Caller needs to have TELUX\_CONFIG\_APPS\_CONFIG permission to invoke this API successfully.

##### Parameters

in	<i>callback</i>	Optional callback to get the response of Config Manager initialization.
----	-----------------	---

##### Returns

pointer of [IConfigManager](#) object.

#### 4.38.1.2 class telux::config::IConfigListener

[IConfigListener](#) interface is used to receive notifications related to any updates in the configurations dynamically.

##### Public member functions

- virtual void [onConfigUpdate](#) (std::string key, std::string value)
- virtual [~IConfigListener](#) ()

##### 4.38.1.2.1 Constructors and Destructors

###### 4.38.1.2.1.1 virtual telux::config::IConfigListener::~~IConfigListener ( ) [virtual]

##### 4.38.1.2.2 Member Function Documentation

###### 4.38.1.2.2.1 virtual void telux::config::IConfigListener::onConfigUpdate ( std::string *key*, std::string *value* ) [virtual]

This API is invoked when there is any update in the configurations dynamically.

##### Parameters

in	<i>key</i>	- The key updated in the configurations.
in	<i>value</i>	- The corresponding value for the key that was updated in the configurations.

#### 4.38.1.3 class telux::config::IConfigManager

[IConfigManager](#) provides APIs to retrieve an instance of the manager, APIs for processes to update and retrieve configurations dynamically.

## Public member functions

- virtual `telux::common::ServiceStatus getServiceStatus ()=0`
- virtual `telux::common::Status registerListener (std::weak_ptr< IConfigListener > listener)=0`
- virtual `telux::common::Status deregisterListener (std::weak_ptr< IConfigListener > listener)=0`
- virtual `telux::common::Status setConfig (const std::string key, const std::string value)=0`
- virtual const `std::string getConfig (const std::string key)=0`
- virtual const `std::map< std::string, std::string > getAllConfigs ()=0`
- virtual `~IConfigManager ()`

### 4.38.1.3.1 Constructors and Destructors

4.38.1.3.1.1 `virtual telux::config::IConfigManager::~~IConfigManager ( ) [virtual]`

Destructor of `IConfigManager`

### 4.38.1.3.2 Member Function Documentation

4.38.1.3.2.1 `virtual telux::common::ServiceStatus telux::config::IConfigManager::getServiceStatus ( ) [pure virtual]`

This status indicates whether the manager object is in a usable state or not.

#### Returns

`SERVICE_AVAILABLE` - if apps config manager is ready to use. `SERVICE_UNAVAILABLE` - if apps config manager is temporarily unavailable to use. `SERVICE_FAILED` - if apps config manager encountered an irrecoverable failure and can not be used.

4.38.1.3.2.2 `virtual telux::common::Status telux::config::IConfigManager::registerListener ( std::weak_ptr< IConfigListener > listener ) [pure virtual]`

This API is used to register a listener for getting the updates when the configurations are updated dynamically.

#### Parameters

<code>in</code>	<code>listener</code>	- Pointer of object that processes the notification.
-----------------	-----------------------	--

#### Returns

Status of registerForUpdates i.e success or suitable status code.

#### 4.38.1.3.2.3 `virtual telux::common::Status telux::config::IConfigManager::deregisterListener ( std::weak_ptr< IConfigListener > listener ) [pure virtual]`

This API is used to deregister a listener from getting the updates when the configurations are updated dynamically.

##### Parameters

in	<i>listener</i>	- Pointer of object that processes the notification.
----	-----------------	--

##### Returns

Status of registerForUpdates i.e success or suitable status code.

#### 4.38.1.3.2.4 `virtual telux::common::Status telux::config::IConfigManager::setConfig ( const std::string key, const std::string value ) [pure virtual]`

This API is used to update the key and the corresponding value in the configurations dynamically.

On platforms with Access control enabled, if -

1. /etc/tel.conf needs to be updated - caller needs to have TELUX\_SET\_GLOBAL\_CONFIG permission to invoke this API successfully.
2. App specific conf needs to be updated - caller needs to have TELUX\_SET\_LOCAL\_CONFIG permission to invoke this API successfully.

In order to update any configuration onto the file, all the permissions needed - DAC permissions and sepolicy requirements, should be taken care by the application.

The API does not perform any strict checking for the value being set. Please refer to tel.conf for valid values for configuration items.

##### Parameters

in	<i>key</i>	- The key that needs to be updated in the configurations.
in	<i>value</i>	- The corresponding value for the key that needs the update in the configurations.

##### Returns

Status of setConfig i.e success or suitable status code.

#### 4.38.1.3.2.5 `virtual const std::string telux::config::IConfigManager::getConfig ( const std::string key ) [pure virtual]`

This API is used to retrieve the value for the corresponding key from the configurations dynamically.

##### Parameters

in	<i>key</i>	- The key whose value is to be retrieved from the configurations.
----	------------	---

**Returns**

The value for the key passed.

**4.38.1.3.2.6** `virtual const std::map<std::string, std::string> telux::config::IConfigManager::getAllConfig( ) [pure virtual]`

This API is used to retrieve all the configurations for the application at present.

**Returns**

A map of key-value pairs depicting all the application's configurations at present.

**4.38.1.4 struct telux::config::ConfigInfo****Data fields**

Type	Field	Description
<a href="#">ConfigId</a>	id	id - stores the id of the configuration type - stores config type size - stores the size of the configuration desc - stores the configuration description version - stores version of the config file
<a href="#">ConfigType</a>	type	
uint32_t	size	
string	desc	
uint32_t	version	

**4.38.1.5 class telux::config::IModemConfigListener**

Listener class for getting notifications related to configuration change detection. The client needs to implement these methods as briefly as possible and avoid blocking calls in it. The methods in this class can be invoked from multiple different threads. Client needs to make sure that the implementation is thread-safe.

**Public member functions**

- virtual void [onConfigUpdateStatus](#) ([ConfigUpdateStatus](#) status, int slotId)
- virtual [~IModemConfigListener](#) ()

**4.38.1.5.1 Constructors and Destructors**

**4.38.1.5.1.1** `virtual telux::config::IModemConfigListener::~~IModemConfigListener ( ) [virtual]`

Destructor of [IModemConfigListener](#)

### 4.38.1.5.2 Member Function Documentation

#### 4.38.1.5.2.1 virtual void telux::config::IModemConfigListener::onConfigUpdateStatus ( ConfigUpdate↔ Status *status*, int *slotId* ) [virtual]

This function is called when a configuration update is detected. It is applicable only to SOFTWARE config.

#### Parameters

in	<i>status</i>	update status of config.
in	<i>slotId</i>	slotId where update is detected.

### 4.38.1.6 class telux::config::IModemConfigManager

[IModemConfigManager](#) provides interface to list config files present in modem's storage. load a new config file in modem, activate a config file, get active config file information, deactivate a config file, delete config file from the modem's storage, get and set mode of config auto selection, register and deregister listener for config update in modem. The config files are also referred to as MBNs.

#### Public member functions

- virtual bool [isSubsystemReady](#) ()=0
- virtual [telux::common::ServiceStatus](#) [getServiceStatus](#) ()=0
- virtual std::future< bool > [onSubsystemReady](#) ()=0
- virtual [telux::common::Status](#) [requestConfigList](#) ([ConfigListCallback](#) cb)=0
- virtual [telux::common::Status](#) [loadConfigFile](#) (std::string filePath, [ConfigType](#) configType, [telux::common::ResponseCallback](#) cb=nullptr)=0
- virtual [telux::common::Status](#) [activateConfig](#) ([ConfigType](#) configType, [ConfigId](#) configId, int slotId=DEFAULT\_SLOT\_ID, [telux::common::ResponseCallback](#) cb=nullptr)=0
- virtual [telux::common::Status](#) [getActiveConfig](#) ([ConfigType](#) configType, [GetActiveConfigCallback](#) cb, int slotId=DEFAULT\_SLOT\_ID)=0
- virtual [telux::common::Status](#) [deactivateConfig](#) ([ConfigType](#) configType, int slotId=DEFAULT\_SLOT\_ID, [telux::common::ResponseCallback](#) cb=nullptr)=0
- virtual [telux::common::Status](#) [deleteConfig](#) ([ConfigType](#) configType, [ConfigId](#) configId="", [telux::common::ResponseCallback](#) cb=nullptr)=0
- virtual [telux::common::Status](#) [getAutoSelectionMode](#) ([GetAutoSelectionModeCallback](#) cb, int slotId=DEFAULT\_SLOT\_ID)=0
- virtual [telux::common::Status](#) [setAutoSelectionMode](#) ([AutoSelectionMode](#) mode, int slotId=DEFAULT\_SLOT\_ID, [telux::common::ResponseCallback](#) cb=nullptr)=0
- virtual [telux::common::Status](#) [registerListener](#) (std::weak\_ptr< [IModemConfigListener](#) > listener)=0
- virtual [telux::common::Status](#) [deregisterListener](#) (std::weak\_ptr< [IModemConfigListener](#) > listener)=0
- virtual [~IModemConfigManager](#) ()

### 4.38.1.6.1 Constructors and Destructors

**4.38.1.6.1.1** `virtual telux::config::IModemConfigManager::~~IModemConfigManager ( ) [virtual]`

Destructor of [IModemConfigManager](#)

### 4.38.1.6.2 Member Function Documentation

**4.38.1.6.2.1** `virtual bool telux::config::IModemConfigManager::isSubsystemReady ( ) [pure virtual]`

Checks the status of modem config subsystem and returns the result.

#### Returns

If true that means ModemConfigManager is ready for performing config operations.

#### Deprecated

Use [getServiceStatus](#) API

**4.38.1.6.2.2** `virtual telux::common::ServiceStatus telux::config::IModemConfigManager::getServiceStatus ( ) [pure virtual]`

This status indicates whether the manager object is in a usable state or not.

#### Returns

SERVICE\_AVAILABLE - if modem config manager is ready to use. SERVICE\_UNAVAILABLE - if modem config manager is temporarily unavailable to use. SERVICE\_FAILED - if modem config manager encountered an irrecoverable failure and can not be used.

**4.38.1.6.2.3** `virtual std::future<bool> telux::config::IModemConfigManager::onSubsystemReady ( ) [pure virtual]`

Wait for modem config subsystem to be ready.

#### Returns

A future that caller can wait on to be notified when modem config subsystem is ready.

#### Deprecated

Use InitResponseCb callback in factory API [ConfigFactory::getModemConfigManager](#).

**4.38.1.6.2.4** `virtual telux::common::Status telux::config::IModemConfigManager::requestConfigList ( ConfigListCallback cb ) [pure virtual]`

Fetching the list of config files present in modem's storage.

**Parameters**

in	<i>cb</i>	- callback to the Response function.
----	-----------	--------------------------------------

returns SUCCESS if the request to get config list is sent successfully.

**4.38.1.6.2.5** `virtual telux::common::Status telux::config::IModemConfigManager::loadConfigFile ( std::string filePath, ConfigType configType, telux::common::ResponseCallback cb = nullptr ) [pure virtual]`

Loads a new config file into the modem's storage. This is a persistent operation. Only the config files loaded into the modem's storage can be activated.

**Parameters**

in	<i>filePath</i>	- it defines the path to the config file.
in	<i>configType</i>	- type of the config file.
in	<i>cb</i>	- callback to the response function.

returns SUCCESS if the request to load config file is sent successfully.

**4.38.1.6.2.6** `virtual telux::common::Status telux::config::IModemConfigManager::activateConfig ( ConfigType configType, ConfigId configId, int slotId = DEFAULT_SLOT_ID, telux::common::ResponseCallback cb = nullptr ) [pure virtual]`

Activates the config file on specified slot id. A file for activation must be loaded or should already be present in modem's storage.

**Parameters**

in	<i>configType</i>	- type of the config file.
in	<i>configId</i>	- id of the config file.
in	<i>slotId</i>	- it defines the slot id to be selected.
in	<i>cb</i>	- callback to the response function.

**Returns**

SUCCESS if the request to activate config file is sent successfully.

**4.38.1.6.2.7** `virtual telux::common::Status telux::config::IModemConfigManager::getActiveConfig ( ConfigType configType, GetActiveConfigCallback cb, int slotId = DEFAULT_SLOT_ID ) [pure virtual]`

Get the currently active config file information for the specified slot id. In case default config files are activated, would return error.

**Parameters**

in	<i>configType</i>	- type of the config file.
in	<i>cb</i>	- callback to the response function.
in	<i>slotId</i>	- it defines the slot id to be selected.

**Returns**

SUCCESS if the request to get active config information is sent successfully.

**4.38.1.6.2.8** `virtual telux::common::Status telux::config::IModemConfigManager::deactivateConfig ( ConfigType configType, int slotId = DEFAULT_SLOT_ID, telux::common::Response↔ Callback cb = nullptr ) [pure virtual]`

Deactivates the config file for the specified slot id.

**Parameters**

in	<i>configType</i>	- type of the config file.
in	<i>slotId</i>	- slot id to be selected for deactivation of config.
in	<i>cb</i>	- callback to the response function.

**Returns**

SUCCESS if the request to deactivate config file is sent successfully

**4.38.1.6.2.9** `virtual telux::common::Status telux::config::IModemConfigManager::deleteConfig ( ConfigType configType, ConfigId configId = "", telux::common::ResponseCallback cb = nullptr ) [pure virtual]`

Deletes the config file from the modem's storage.

**Parameters**

in	<i>configType</i>	- type of the config file.
in	<i>configId</i>	- id of the config file. This parameter is optional if not provided all the config files of the given config type are deleted from modem's storage.
in	<i>cb</i>	- callback to the Response function.

**Returns**

SUCCESS if the request to delete config file is sent successfully

**4.38.1.6.2.10** `virtual telux::common::Status telux::config::IModemConfigManager::getAutoSelection↔ Mode ( GetAutoSelectionModeCallback cb, int slotId = DEFAULT_SLOT_ID ) [pure virtual]`

Fetching the mode of config auto selection for specified slot id.



**Parameters**

in	<i>cb</i>	- callback to the response function.
in	<i>slotId</i>	- slot id of config.

**Returns**

SUCCESS if the request to get selection mode is sent successfully

**4.38.1.6.2.11** `virtual telx::common::Status telx::config::IModemConfigManager::setAutoSelectionMode ( AutoSelectionMode mode, int slotId = DEFAULT_SLOT_ID, telx::common::ResponseCallback cb = nullptr ) [pure virtual]`

Setting the mode of config auto selection for specified slot id.

**Parameters**

in	<i>mode</i>	- auto selection mode status.
in	<i>slotId</i>	- slot id of the config.
in	<i>cb</i>	- callback to the response function.

**Returns**

SUCCESS if the request to set selection mode is sent successfully.

**4.38.1.6.2.12** `virtual telx::common::Status telx::config::IModemConfigManager::registerListener ( std::weak_ptr< IModemConfigListener > listener ) [pure virtual]`

Registers the listener for indications.

**Parameters**

in	<i>listener</i>	- pointer to implemented listener.
----	-----------------	------------------------------------

**Returns**

SUCCESS if the request to register listener is sent successfully.

**4.38.1.6.2.13** `virtual telx::common::Status telx::config::IModemConfigManager::deregisterListener ( std::weak_ptr< IModemConfigListener > listener ) [pure virtual]`

Deregisters the listener from indications.

**Parameters**

in	<i>listener</i>	- pointer to registered listener.
----	-----------------	-----------------------------------

## Returns

SUCCESS if the request to deregister listener is sent successfully.

## 4.38.2 Enumeration Type Documentation

### 4.38.2.1 enum telux::config::ConfigType [strong]

#### Enumerator

**HARDWARE** For hardware or platform related configuration files

**SOFTWARE** For software or carrier related configuration files

### 4.38.2.2 enum telux::config::AutoSelectionMode [strong]

Selection Mode defines status of auto selection mode for configs.

#### Enumerator

**DISABLED** Auto selection disabled

**ENABLED** Auto selection enabled

### 4.38.2.3 enum telux::config::ConfigUpdateStatus [strong]

ConfigUpdateStatus represent status of config update, a update of config happens when a software config is activated and all segments using the config are updated with new config.

#### Enumerator

**START** start of updation process

**COMPLETE** end of updation process

## 4.39 Sensor

- [Sensor Service](#)
- [Sensor Control](#)
- [Sensor Feature Control](#)

This section contains APIs related to sensor configuration, control, data acquisition and sensor feature control.

## 4.40 Sensor Service

This section contains APIs, data structures and components to access the sensor sub-system.

### 4.40.1 Data Structure Documentation

#### 4.40.1.1 struct telux::sensor::SensorInfo

Information related to sensor.

##### Data fields

Type	Field	Description
int	id	Unique identifier for the sensor.
<a href="#">SensorType</a>	type	The type of sensor, <a href="#">telux::sensor::SensorType</a>
string	name	The name of the sensor This name is used to get a reference to a sensor with <a href="#">telux::sensor::ISensorManager::getSensorClient</a>
string	vendor	The name of the vendor
vector< float >	samplingRates	List of supported sampling rates by the sensor hardware, number of samples per second (Hz)
float	maxSampling↔ Rate	The maximum sampling rate the sensor can be configured for. This can be set in /etc/sensors.conf for each sensor and should be less than the maximum sampling rate supported by the sensor hardware, number of samples per second (Hz)  This attribute should be considered while using the API <a href="#">telux::sensor::ISensorClient::configure</a>
uint32_t	maxBatch↔ Count↔ Supported	Maximum batch count supported by the sensor, i.e. the maximum number of sensor events that the underlying framework can buffer.  This attribute should be considered while using the API <a href="#">telux::sensor::ISensorClient::configure</a>
uint32_t	minBatch↔ Count↔ Supported	Minimum batch count supported by the sensor. This is set in /etc/sensors.conf for each sensor.  This attribute should be considered while using the API <a href="#">telux::sensor::ISensorClient::configure</a>
int	range	The range offered by the sensor. This configuration can be set in /etc/sensors.conf for each sensor.  For accelerometers, this is the number of Gs (force per unit mass due to gravity) in either direction (+/-) on each axis  For gyroscopes, this is the number of degrees per second (dps) in either direction (+/-) along each axis
int	version	The version of the sensor considering the hardware part and the driver
float	resolution	This is the smallest difference between two values reported by this sensor, in meter per second per second for accelerometer, radians per second for gyroscope

Type	Field	Description
float	maxRange	The maximum range this sensor offers, in meter per second per second for accelerometer, radians per second for gyroscope. This attribute depends on the <a href="#">SensorInfo::range</a> of the sensor set in the configuration file. For example, a range of 1G results in a maximum range of approximately 9.8 m/s/s and a range of 2G gives a maximum range of about 19.6 m/s/s.

#### 4.40.1.2 struct telux::sensor::SensorConfiguration

Configurable parameters of a sensor.

##### Data fields

Type	Field	Description
float	samplingRate	<p>The sampling rate for the sensor, number of samples per second (Hz)</p> <p>In case of <a href="#">telux::sensor::ISensorClient::configure</a>, the requested sampling rate should be one of the sampling rates provided in the <a href="#">telux::sensor::SensorInfo::samplingRates</a> and should be less than the <a href="#">telux::sensor::SensorInfo::maxSamplingRate</a>.</p> <p>If the requested sampling rate is less than the minimum value in the <a href="#">telux::sensor::SensorInfo::samplingRates</a>, it will be set to the least of the values in <a href="#">telux::sensor::SensorInfo::samplingRates</a></p> <p>If the requested sampling rate is not one of the supported sampling rates in <a href="#">telux::sensor::SensorInfo::samplingRates</a>, the requested value is floored to the nearest value in <a href="#">telux::sensor::SensorInfo::samplingRates</a></p> <p>Consider <a href="#">telux::sensor::SensorInfo::samplingRates</a> having values 12, 26, 52. If requested sampling rate in configure API is 7, the sampling rate considered by the sensor framework would be 12. If requested sampling rate in configure API is 51, the sampling rate considered by the sensor framework would be 26.</p> <p>In case of a configuration update received via <a href="#">telux::sensor::ISensorEventListener::onConfigurationUpdate</a>, the current sampling rate configuration is passed to the listener</p>

Type	Field	Description
uint32_t	batchCount	<p>The batch count of the sensor.</p> <p>Batch count is the count of number of samples the underlying framework would buffer before notifying the client of the data. The intention is to reduce the number of interactions between the hardware, framework and the user application to reduce power consumption, improve compute efficiency and reduce number of interactions between different components. It is important to consider latency while deciding the batch count for a sensor. Higher the batch count, more is the latency for the samples.</p> <p>In case of <a href="#">telux::sensor::ISensorClient::configure</a>, the requested batch count should be lesser than the maximum supported batch count <a href="#">telux::sensor::SensorInfo::maxBatchCountSupported</a>. Also, the batch count considered is impacted by the <a href="#">telux::sensor::SensorInfo::minBatchCountSupported</a>.</p> <p>If the requested batch count is less than <a href="#">telux::sensor::SensorInfo::minBatchCountSupported</a>, it will be set to <a href="#">telux::sensor::SensorInfo::minBatchCountSupported</a></p> <p>If the requested batch count is not a multiple of <a href="#">telux::sensor::SensorInfo::minBatchCountSupported</a>, the requested value is floored to the nearest multiple of <a href="#">telux::sensor::SensorInfo::minBatchCountSupported</a></p> <p>Consider <a href="#">telux::sensor::SensorInfo::minBatchCountSupported</a> having a value of 7. If requested batchCount in configure API is 2, the batchCount considered by the sensor framework would be 7. If requested batchCount in configure API is 23, the batchCount considered by the sensor framework would be 21.</p> <p>In case of a configuration update <a href="#">telux::sensor::ISensorEventListener::onConfigurationUpdate</a>, this field indicates the current configuration for batch count.</p>
<a href="#">SensorConfig↔Mask</a>	validityMask	<p>Bitset indicating the validity of the received sensor configuration via <a href="#">telux::sensor::ISensorClient::getConfiguration</a> and <a href="#">telux::sensor::ISensorEventListener::onConfigurationUpdate</a>. The configuration items that were never set would have return false when tested for using <code>std::bitset::test</code>.</p> <p>Further, this bitset should be set by the user to indicate the valid fields while configuring the sensor using <a href="#">telux::sensor::ISensorClient::configure</a>. For continuous stream of data from a sensor, the validity of SAMPLING_RATE and BATCH_COUNT from <a href="#">SensorConfigParams</a> should be considered. If the sensor had been already configured with both sampling rate and batch count, it is possible to reconfigure the sensor partially with just one of these attributes and setting the required validity flag.</p>
<a href="#">SensorConfig↔Mask</a>	updateMask	<p>Bitset indicating the parameters that were updated since last notification via <a href="#">telux::sensor::ISensorEventListener::onConfigurationUpdate</a></p>

### 4.40.1.3 struct telux::sensor::MotionSensorData

Structure of a single sample from a motion sensor.

#### Data fields

Type	Field	Description
float	x	x-axis data, meter per second per second for accelerometer, radians per second for gyroscope
float	y	y-axis data, meter per second per second for accelerometer, radians per second for gyroscope
float	z	z-axis data, meter per second per second for accelerometer, radians per second for gyroscope

### 4.40.1.4 struct telux::sensor::UncalibratedMotionSensorData

Structure of a single sample from uncalibrated motion sensor.

#### Data fields

Type	Field	Description
<a href="#">MotionSensorData</a> ↔	data	Uncalibrated motion sensor data <a href="#">MotionSensorData</a>
<a href="#">MotionSensorData</a> ↔	bias	Bias for the uncalibrated data <a href="#">MotionSensorData</a>

### 4.40.1.5 struct telux::sensor::SensorEvent

Structure of a single sensor event.

#### Data fields

Type	Field	Description
uint64_t	timestamp	Timestamp when the event was generated on the hardware, nanosecond since boot-up
union <a href="#">SensorEvent</a> ↔	__unnamed_↔ _	Sensor data

### 4.40.1.6 struct telux::sensor::SensorFeature

Feature offered by sensor hardware and/or software framework.

#### Data fields

Type	Field	Description
string	name	Name of the feature

#### 4.40.1.7 struct telux::sensor::SensorFeatureEvent

Structure of an event that is generated from a sensor feature.

##### Data fields

Type	Field	Description
uint64_t	timestamp	Best estimate of timestamp indicating the time of occurrence of the event, nanosecond since boot-up
string	name	Name of the feature that generated the event
int	id	The ID of the generated event

#### 4.40.1.8 class telux::sensor::SensorFactory

[SensorFactory](#) is the central factory to create instances of sensor objects.

##### Public member functions

- virtual std::shared\_ptr< [ISensorManager](#) > [getSensorManager](#) (telux::common::InitResponseCb clientCallback=nullptr)=0
- virtual std::shared\_ptr< [ISensorFeatureManager](#) > [getSensorFeatureManager](#) (telux::common::InitResponseCb clientCallback=nullptr)=0

##### Static Public Member Functions

- static [SensorFactory](#) & [getInstance](#) ()

#### 4.40.1.8.1 Member Function Documentation

##### 4.40.1.8.1.1 static SensorFactory& telux::sensor::SensorFactory::getInstance ( ) [static]

Get Sensor Factory instance.

##### Returns

The singleton instance of [SensorFactory](#) object

##### 4.40.1.8.1.2 virtual std::shared\_ptr<ISensorManager> telux::sensor::SensorFactory::getSensorManager ( telux::common::InitResponseCb clientCallback = nullptr ) [pure virtual]

Get an instance of Sensor Manager. The ownership of the returned object is with the caller of this method. The reference to the instance is not held by the [SensorFactory](#). If the returned reference is released, any request for [ISensorManager](#) shall result in creation of a new instance

##### Parameters

in	<i>clientCallback</i>	Optional callback to get the initialization status of SensorManager <a href="#">telux::common::InitResponseCb</a>
----	-----------------------	---



**Returns**

An instance of [ISensorManager](#) If the initialization of the manager and underlying system fails, nullptr is returned

**4.40.1.8.1.3** `virtual std::shared_ptr<ISensorFeatureManager> telux::sensor::SensorFactory::get←  
SensorFeatureManager ( telux::common::InitResponseCb clientCallback = nullptr )  
[pure virtual]`

Get an instance of Sensor Feature Manager. The ownership of the returned object is with the caller of this method. The reference to the instance is not held by the [SensorFactory](#). If the returned reference is released, any request for [ISensorFeatureManager](#) shall result in creation of a new instance

**Parameters**

in	<i>clientCallback</i>	Optional callback to get the initialization status of SensorFeatureManager <a href="#">telux::common::InitResponseCb</a>
----	-----------------------	--

**Returns**

An instance of [ISensorFeatureManager](#) If the initialization of the manager and underlying system fails, nullptr is returned

**4.40.1.9 union telux::sensor::SensorEvent.\_\_unnamed\_\_**

Sensor data

**Data fields**

Type	Field	Description
<a href="#">Motion← SensorData</a>	calibrated	Calibrated data - should be accessed when the <a href="#">SensorType</a> that generated the sensor event accounts for calibration - <a href="#">SensorType::ACCELEROMETER</a> or <a href="#">SensorType::GYROSCOPE</a>
<a href="#">Uncalibrated← Motion← SensorData</a>	uncalibrated	Uncalibrated data - should be accessed when the <a href="#">SensorType</a> that generated the sensor event provides uncalibrated data along with bias information - <a href="#">SensorType::ACCELEROMETER_UNCALIBRATED</a> or <a href="#">SensorType::GYROSCOPE_UNCALIBRATED</a>

**4.40.2 Enumeration Type Documentation****4.40.2.1 enum telux::sensor::SensorType [strong]**

Enumeration of different sensors available.

**Enumerator**

**ACCELEROMETER** ID for the accelerometer sensor

**GYROSCOPE** ID for the gyroscope sensor

**GYROSCOPE\_UNCALIBRATED** ID for the uncalibrated gyroscope sensor

**ACCELEROMETER\_UNCALIBRATED** ID for the uncalibrated accelerometer sensor  
**INVALID** Denotes that the sensor type is either unknown or invalid

#### 4.40.2.2 enum telux::sensor::SensorConfigParams

Enumeration listing the different configuration parameters in [SensorConfiguration](#)

##### Enumerator

**SAMPLING\_RATE** Corresponds to [SensorConfiguration::samplingRate](#)  
**BATCH\_COUNT** Corresponds to [SensorConfiguration::batchCount](#)  
**SENSOR\_CONFIG\_NUM\_PARAMS**

#### 4.40.2.3 enum telux::sensor::SelfTestType [strong]

Types of self test the sensor can perform.

##### Enumerator

**POSITIVE** To initiate self test with positive values  
**NEGATIVE** To initiate self test with negative values

## 4.41 Sensor Control

This section contains APIs related to sensor configuration, sensor control and data acquisition from sensors.

### 4.41.1 Data Structure Documentation

#### 4.41.1.1 class telux::sensor::ISensorEventListener

[ISensorEventListener](#) interface is used to receive notifications related to sensor events and configuration updates.

The listener method can be invoked from multiple different threads. Client needs to make sure that implementation is thread-safe.

#### Public member functions

- virtual void [onEvent](#) (std::shared\_ptr< std::vector< [SensorEvent](#) >> events)
- virtual void [onConfigurationUpdate](#) ([SensorConfiguration](#) configuration)
- virtual [~ISensorEventListener](#) ()

#### 4.41.1.1.1 Constructors and Destructors

**4.41.1.1.1.1 virtual telux::sensor::ISensorEventListener::~~ISensorEventListener ( ) [virtual]**

The destructor for the sensor event listener

#### 4.41.1.1.2 Member Function Documentation

**4.41.1.1.2.1 virtual void telux::sensor::ISensorEventListener::onEvent ( std::shared\_ptr< std::vector< [SensorEvent](#) >> *events* ) [virtual]**

This function is called to notify about available sensor events. Note the following constraints on this listener API It shall not perform time consuming (compute or I/O intensive) operations on this thread It shall not invoke a sensor APIs on this thread due to the underlying concurrency model

On platforms with Access control enabled, the client needs to have TELUX\_SENSOR\_DATA\_READ permission for this listener API to be invoked.

#### Parameters

in	<i>events</i>	- List of sensor events
----	---------------	-------------------------

**4.41.1.1.2.2 virtual void telux::sensor::ISensorEventListener::onConfigurationUpdate ( [SensorConfiguration](#) *configuration* ) [virtual]**

This function is called to notify any change in the configuration of the [ISensorClient](#) object this listener is associated with.

On platforms with Access control enabled, the client needs to have TELUX\_SENSOR\_DATA\_READ

permission for this listener API to be invoked.

### Parameters

<i>in</i>	<i>configuration</i>	- The new configuration of the sensor client. <a href="#">telux::sensor::SensorConfiguration</a> . Fields that have changed can be identified using the <a href="#">telux::sensor::SensorConfiguration::updateMask</a> and fields that are valid can be identified using <a href="#">telux::sensor::SensorConfiguration::validityMask</a>
-----------	----------------------	--

#### 4.41.1.2 class `telux::sensor::ISensorClient`

[ISensorClient](#) interface is used to access the different services provided by the sensor framework to configure, activate and acquire sensor data.

Each instance of this class is a unique sensor client to the underlying sensor framework and any number of such clients can exist in a given process. Each of these clients can acquire data from the underlying sensor framework with different configurations.

#### Public member functions

- virtual [SensorInfo](#) `getSensorInfo ()=0`
- virtual [telux::common::Status](#) `configure (SensorConfiguration configuration)=0`
- virtual [SensorConfiguration](#) `getConfiguration ()=0`
- virtual [telux::common::Status](#) `activate ()=0`
- virtual [telux::common::Status](#) `deactivate ()=0`
- virtual [telux::common::Status](#) `selfTest (SelfTestType selfTestType, SelfTestResultCallback cb)=0`
- virtual [telux::common::Status](#) `registerListener (std::weak_ptr< ISensorEventListener > listener)=0`
- virtual [telux::common::Status](#) `deregisterListener (std::weak_ptr< ISensorEventListener > listener)=0`
- virtual `~ISensorClient ()`
- virtual [telux::common::Status](#) `enableLowPowerMode ()=0`
- virtual [telux::common::Status](#) `disableLowPowerMode ()=0`

#### 4.41.1.2.1 Constructors and Destructors

##### 4.41.1.2.1.1 virtual `telux::sensor::ISensorClient::~ISensorClient ( ) [virtual]`

Destructor for [ISensorClient](#).

Internally, the sensor client object is first deactivated and then destroyed.

#### 4.41.1.2.2 Member Function Documentation

##### 4.41.1.2.2.1 virtual SensorInfo telux::sensor::ISensorClient::getSensorInfo ( ) [pure virtual]

Get the information related to sensor

#### Returns

information related to sensor - [telux::sensor::SensorInfo](#)

##### 4.41.1.2.2.2 virtual telux::common::Status telux::sensor::ISensorClient::configure ( Sensor↔ Configuration *configuration* ) [pure virtual]

Configure the sensor client with desired sampling rate and batch count. Any change in sampling rate or batch count of the sensor will be notified via [telux::sensor::ISensorEventListener::onConfigurationUpdate](#).

In case a sensor client needs to be reconfigured after having been activated, the client should be deactivated, configured and activated again as a part of the reconfiguration process.

It is always recommended that configuration of a client is done before activating it. If a client is activated without configuration, the client is configured with a default configuration and activated. The default configuration would have the sampling rate set to minimum sampling rate supported [telux::sensor::SensorInfo::samplingRates](#) and the batch count set to maximum batch count supported [telux::sensor::SensorInfo::maxBatchCountSupported](#)

On platforms with Access control enabled, Caller needs to have TELUX\_SENSOR\_DATA\_READ permission to invoke this API successfully.

#### Parameters

in	<i>configuration</i>	- The desired configuration for the client <a href="#">telux::sensor::SensorConfiguration</a> . Ensure the required validity mask <a href="#">telux::sensor::SensorConfiguration::validityMask</a> is set for the configuration.
----	----------------------	--

#### Returns

status of configuration request - [telux::common::Status](#)

##### 4.41.1.2.2.3 virtual SensorConfiguration telux::sensor::ISensorClient::getConfiguration ( ) [pure virtual]

Get the current configuration of this sensor client

On platforms with Access control enabled, Caller needs to have TELUX\_SENSOR\_DATA\_READ permission to invoke this API successfully.

#### Returns

the current configuration of the client. [telux::sensor::SensorConfiguration::validityMask](#) should be checked to know which of the fields in the returned configuration is valid.

#### 4.41.1.2.2.4 **virtual telux::common::Status telux::sensor::ISensorClient::activate ( ) [pure virtual]**

Activate the sensor client. Once activated, any available sensor event will be notified via [telux::sensor::ISensorEventListener::onEvent](#)

It is always recommended that configuration of a client is done before activating it. If a client is activated without configuration, the client is configured with the default configuration and activated. The default configuration would have the sampling rate set to minimum sampling rate supported [telux::sensor::SensorInfo::samplingRates](#) and the batch count set to maximum batch count supported [telux::sensor::SensorInfo::maxBatchCountSupported](#). Activating an already activated sensor would result in the API returning [telux::common::Status::SUCCESS](#).

Activating this sensor client would not impact other inactive sensor clients.

On platforms with Access control enabled, Caller needs to have TELUX\_SENSOR\_DATA\_READ permission to invoke this API successfully.

#### Returns

status of activation request - [telux::common::Status](#)

#### 4.41.1.2.2.5 **virtual telux::common::Status telux::sensor::ISensorClient::deactivate ( ) [pure virtual]**

Deactivate the sensor client. Once deactivated, no further sensor events will be notified via [telux::sensor::ISensorEventListener::onEvent](#). Deactivating an already inactive sensor would result in the API returning [telux::common::Status::SUCCESS](#).

Deactivating this sensor client would not impact other active sensor clients.

On platforms with Access control enabled, Caller needs to have TELUX\_SENSOR\_DATA\_READ permission to invoke this API successfully.

#### Returns

status of deactivation request - [telux::common::Status](#)

#### 4.41.1.2.2.6 **virtual telux::common::Status telux::sensor::ISensorClient::selfTest ( SelfTestType selfTestType, SelfTestResultCallback cb ) [pure virtual]**

Initiate self test on this sensor

If there are active data acquisition sessions corresponding to this sensor, these will be paused and the self test is initiated. Once the self test is complete the sensor data sessions will be restored.

On platforms with Access control enabled, Caller needs to have TELUX\_SENSOR\_PRIVILEGED\_OPS permission to invoke this API successfully.

#### Parameters

in	<i>selfTestType</i>	- The type of self test to be performed - <a href="#">telux::sensor::SelfTestType</a>
----	---------------------	--

in	<i>cb</i>	- Callback to get the result of the self test initiated
----	-----------	---

**Returns**

status of the request - [telux::common::Status](#). Note that the result of the self test done by the sensor is provided via the callback - [telux::sensor::SelfTestResultCallback](#)

**4.41.1.2.2.7** `virtual telux::common::Status telux::sensor::ISensorClient::registerListener ( std::weak_ptr< ISensorEventListener > listener ) [pure virtual]`

Register a listener for sensor related events

**Returns**

status of registration request - [telux::common::Status](#)

**4.41.1.2.2.8** `virtual telux::common::Status telux::sensor::ISensorClient::deregisterListener ( std::weak_ptr< ISensorEventListener > listener ) [pure virtual]`

Deregister a sensor event listener

**Returns**

status of deregistration request - [telux::common::Status](#)

**4.41.1.2.2.9** `virtual telux::common::Status telux::sensor::ISensorClient::enableLowPowerMode ( ) [pure virtual]`

Deprecated APIs Request the sensor to operate in low power mode. The sensor should be in deactivated state to exercise this API. The success of this request depends on the capabilities of the underlying hardware.

**Returns**

status of request - [telux::common::Status](#)

**Deprecated**

This API is no longer supported.

#### 4.41.1.2.2.10 virtual telux::common::Status telux::sensor::ISensorClient::disableLowPowerMode ( ) [pure virtual]

Request the sensor to exit low power mode. The sensor should be in deactivated state to exercise this API. The success of this request depends on the capabilities of the underlying hardware.

#### Returns

status of request - [telux::common::Status](#)

#### Deprecated

This API is no longer supported.

### 4.41.1.3 class telux::sensor::ISensorManager

Sensor Manager class provides APIs to interact with the sensor sub-system and get access to other sensor objects which can be used to configure, activate or get data from the individual sensors available - Gyro, Accelerometer, etc.

#### Public member functions

- virtual [telux::common::ServiceStatus](#) getServiceStatus ()=0
- virtual [telux::common::Status](#) getAvailableSensorInfo (std::vector< [SensorInfo](#) > &info)=0
- virtual [telux::common::Status](#) getSensor (std::shared\_ptr< [ISensorClient](#) > &sensor, std::string name)=0
- virtual [telux::common::Status](#) getSensorClient (std::shared\_ptr< [ISensorClient](#) > &sensor, std::string name)=0
- virtual [~ISensorManager](#) ()

#### 4.41.1.3.1 Constructors and Destructors

##### 4.41.1.3.1.1 virtual telux::sensor::ISensorManager::~ISensorManager ( ) [virtual]

Destructor for [ISensorManager](#)

#### 4.41.1.3.2 Member Function Documentation

##### 4.41.1.3.2.1 virtual telux::common::ServiceStatus telux::sensor::ISensorManager::getServiceStatus ( ) [pure virtual]

Checks the status of sensor sub-system and returns the result.

#### Returns

the status of sensor sub-system status [telux::common::ServiceStatus](#)



#### 4.41.1.3.2.2 virtual telux::common::Status telux::sensor::ISensorManager::getAvailableSensorInfo ( std::vector< SensorInfo > & info ) [pure virtual]

Get information related to the sensors available in the system.

##### Parameters

out	<i>info</i>	List of information on sensors available in the system <a href="#">telux::sensor::SensorInfo</a>
-----	-------------	---

##### Returns

status of the request [telux::common::Status](#)

#### 4.41.1.3.2.3 virtual telux::common::Status telux::sensor::ISensorManager::getSensor ( std::shared\_ptr< ISensorClient > & sensor, std::string name ) [pure virtual]

Get an instance of [ISensorClient](#) to interact with the underlying sensor. The provided instance is not a singleton. Everytime this method is called a new sensor object is created. It is the caller's responsibility to manage the object's lifetime. Every instance of the sensor returned acts as new client and can configure the underlying sensor with it's own configuration and it's own callbacks for [telux::sensor::SensorEvent](#) and configuration update among other events [telux::sensor::ISensorEventListener](#).

##### Parameters

out	<i>sensor</i>	- An instance of <a href="#">telux::sensor::ISensorClient</a> to interact with the underlying sensor is provided as a result of the method If the initialization of the sensor and underlying system fails, sensor is set to nullptr
in	<i>name</i>	- The unique name of the sensor <a href="#">telux::sensor::SensorInfo::name</a> that was provided in the list of sensor information by <a href="#">telux::sensor::ISensorManager::getAvailableSensorInfo</a>

##### Returns

Status of request [telux::common::Status](#)

##### Deprecated

Use [getSensorClient](#) API.

#### 4.41.1.3.2.4 virtual telux::common::Status telux::sensor::ISensorManager::getSensorClient ( std::shared\_ptr< ISensorClient > & sensor, std::string name ) [pure virtual]

Get an instance of [ISensorClient](#) to interact with the underlying sensor. The provided instance is not a singleton. Everytime this method is called a new sensor object is created. It is the caller's responsibility to manage the object's lifetime. Every instance of the sensor returned acts as new client and can configure the underlying sensor with it's own configuration and it's own callbacks for [telux::sensor::SensorEvent](#) and configuration update among other events [telux::sensor::ISensorEventListener](#).

**Parameters**

out	<i>sensor</i>	- An instance of <a href="#">telux::sensor::ISensorClient</a> to interact with the underlying sensor is provided as a result of the method. If the initialization of the sensor and underlying system fails, sensor is set to nullptr
in	<i>name</i>	- The unique name of the sensor <a href="#">telux::sensor::SensorInfo← ::name</a> that was provided in the list of sensor information by <a href="#">telux::sensor::ISensorManager::getAvailableSensorInfo</a>

**Returns**

Status of request [telux::common::Status](#)

## 4.42 Sensor Feature Control

This section contains APIs related to controlling the features the sensor sub-system offers.

### 4.42.1 Data Structure Documentation

#### 4.42.1.1 class `telux::sensor::ISensorFeatureEventListener`

`ISensorFeatureEventListener` interface is used to receive notifications related to sensor feature events.

The listener method can be invoked from multiple different threads. Client needs to make sure that implementation is thread-safe.

#### Public member functions

- virtual void `onEvent` (`SensorFeatureEvent` event)
- virtual void `onBufferedEvent` (`std::string` sensorName, `std::shared_ptr< std::vector< SensorEvent >>` events, `bool` isLast)
- virtual `~ISensorFeatureEventListener` ()

#### 4.42.1.1.1 Constructors and Destructors

**4.42.1.1.1 virtual `telux::sensor::ISensorFeatureEventListener::~ISensorFeatureEventListener` ( )**  
[`virtual`]

The destructor for the sensor feature event listener

#### 4.42.1.1.2 Member Function Documentation

**4.42.1.1.2.1 virtual void `telux::sensor::ISensorFeatureEventListener::onEvent` ( `SensorFeatureEvent event` )** [`virtual`]

This function is called to notify about sensor feature events

#### Parameters

<code>in</code>	<code>event</code>	- The sensor feature event <code>telux::sensor::SensorFeatureEvent</code> that got triggered
-----------------	--------------------	--

On platforms with Access control enabled, the client needs to have `TELUX_SENSOR_FEATURE_CONTROL` permission for this listener API to be invoked.

**4.42.1.1.2.2 virtual void `telux::sensor::ISensorFeatureEventListener::onBufferedEvent` ( `std::string sensorName`, `std::shared_ptr< std::vector< SensorEvent >>` events, `bool isLast` )**  
[`virtual`]

This function is called to notify about available sensor events that caused one or more sensor feature events `SensorFeatureEvent` to occur.

The sensor events that occurred when the apps processor was in sleep mode and triggered the sensor feature to occur will be buffered and delivered using this method instead of [telux::sensor::ISensorEventListener::onEvent](#).

In case a sensor event occurs when the system is active, this listener is not invoked. In this case, the required sensor data that triggered the feature can be obtained from the [telux::sensor::ISensorEventListener::onEvent](#) listener interface.

Note the following constraints on this listener API It shall not perform time consuming (compute or I/O intensive) operations on this thread It shall not invoke an sensor APIs on this thread due to the underlying concurrency model

On platforms with Access control enabled, the client needs to have `TELUX_SENSOR_FEATURE_CONTROL` permission for this listener API to be invoked.

### Parameters

in	<i>sensorName</i>	- The name of the sensor that generated the buffered events
in	<i>events</i>	- List of sensor events
in	<i>isLast</i>	- Indicate if this is last notification for the buffered events.

Multiple [@ref telux::sensor::SensorFeature](#) can be [@ref telux::sensor::enableFeature](#), whose notification sequence. *isLast* will be set to true to signify last event

#### 4.42.1.2 class `telux::sensor::ISensorFeatureManager`

Sensor Feature Manager class provides APIs to interact with the sensor framework to list the available features, enable them or disable them. The availability of sensor features depends on the capabilities of the underlying hardware.

#### Public member functions

- virtual [telux::common::ServiceStatus](#) `getServiceStatus ()`=0
- virtual [telux::common::Status](#) `getAvailableFeatures (std::vector< SensorFeature > &features)`=0
- virtual [telux::common::Status](#) `enableFeature (std::string name)`=0
- virtual [telux::common::Status](#) `disableFeature (std::string name)`=0
- virtual [telux::common::Status](#) `registerListener (std::weak_ptr< ISensorFeatureEventListener > listener)`=0
- virtual [telux::common::Status](#) `deregisterListener (std::weak_ptr< ISensorFeatureEventListener > listener)`=0
- virtual `~ISensorFeatureManager ()`

#### 4.42.1.2.1 Constructors and Destructors

4.42.1.2.1.1 `virtual telux::sensor::ISensorFeatureManager::~ISensorFeatureManager ( ) [virtual]`

Destructor for [ISensorFeatureManager](#)

#### 4.42.1.2.2 Member Function Documentation

4.42.1.2.2.1 `virtual telux::common::ServiceStatus telux::sensor::ISensorFeatureManager::getService←  
Status ( ) [pure virtual]`

Checks the status of sensor sub-system and returns the result.

##### Returns

the status of sensor sub-system status [telux::common::ServiceStatus](#)

4.42.1.2.2.2 `virtual telux::common::Status telux::sensor::ISensorFeatureManager::getAvailable←  
Features ( std::vector< SensorFeature > & features ) [pure virtual]`

Request the sensor framework to provide the available features. The feature could be offered by the sensor framework or the underlying hardware.

##### Parameters

out	<i>features</i>	List of sensor features the sensor framework offers
-----	-----------------	---

##### Returns

status of the request [telux::common::Status](#)

4.42.1.2.2.3 `virtual telux::common::Status telux::sensor::ISensorFeatureManager::enableFeature (   
std::string name ) [pure virtual]`

Enable the requested feature.

Enabling a sensor feature when the system is active would additionally require enabling the corresponding sensor which is used by the sensor feature. For instance, if the sensor feature uses the accelerometer data, in addition to calling this method, the [telux::sensor::ISensorClient::activate](#) should also be invoked for the required sensor, in this case, the accelerometer.

If the sensor feature only needs to be enabled during suspend mode, just enabling the sensor feature using this method would be sufficient. The underlying framework would take care to enable the required sensor when the system is about to enter suspend state.

On platforms with Access control enabled, Caller needs to have `TELUX_SENSOR_FEATURE_CONTROL` permission to invoke this API successfully.

**Parameters**

in	<i>name</i>	The name of the feature to be enabled. Enabling an already enabled feature would result in the API returning <a href="#">telux::common::Status::SUCCESS</a> .
----	-------------	---

**Returns**

status of the request [telux::common::Status](#)

#### 4.42.1.2.2.4 virtual [telux::common::Status](#) [telux::sensor::ISensorFeatureManager::disableFeature](#) ( `std::string name` ) [pure virtual]

Disable the requested feature

**Parameters**

in	<i>name</i>	The name of the feature to be disabled. Disabling an already disabled feature would result in the API returning <a href="#">telux::common::Status::SUCCESS</a> . On platforms with Access control enabled, Caller needs to have <code>TELUX_SENSOR_FEATURE_CONTROL</code> permission to invoke this API successfully.
----	-------------	---

**Returns**

status of the request [telux::common::Status](#)

#### 4.42.1.2.2.5 virtual [telux::common::Status](#) [telux::sensor::ISensorFeatureManager::registerListener](#) ( `std::weak_ptr< ISensorFeatureEventListener > listener` ) [pure virtual]

Register a listener for sensor feature related events

**Returns**

status of registration request - [telux::common::Status](#)

#### 4.42.1.2.2.6 virtual [telux::common::Status](#) [telux::sensor::ISensorFeatureManager::deregisterListener](#) ( `std::weak_ptr< ISensorFeatureEventListener > listener` ) [pure virtual]

Deregister a sensor feature event listener

**Returns**

status of deregistration request - [telux::common::Status](#)

## 4.43 Platform

- [Filesystem](#)
- [DeviceInfo](#)
- [Hardware Antenna](#)
- [Time](#)

This section contains APIs related to configure platform functionalities and acquire information from the sub-components.

### 4.43.1 Data Structure Documentation

#### 4.43.1.1 class telux::platform::PlatformFactory

[PlatformFactory](#) allows creation of Platform services related classes.

##### Public member functions

- virtual std::shared\_ptr< [IFsManager](#) > [getFsManager](#) (telux::common::InitResponseCb callback=nullptr)=0
- virtual std::shared\_ptr< [IDeviceInfoManager](#) > [getDeviceInfoManager](#) (telux::common::InitResponseCb callback=nullptr)=0
- virtual std::shared\_ptr< [ITimeManager](#) > [getTimeManager](#) (telux::common::InitResponseCb callback=nullptr)=0
- virtual std::shared\_ptr< [hardware::IAntennaManager](#) > [getAntennaManager](#) (telux::common::InitResponseCb callback=nullptr)=0

##### Static Public Member Functions

- static [PlatformFactory](#) & [getInstance](#) ()

#### 4.43.1.1.1 Member Function Documentation

##### 4.43.1.1.1.1 static PlatformFactory& telux::platform::PlatformFactory::getInstance ( ) [static]

Get instance of platform Factory

##### 4.43.1.1.1.2 virtual std::shared\_ptr<IFsManager> telux::platform::PlatformFactory::getFsManager ( telux::common::InitResponseCb callback = nullptr ) [pure virtual]

Get instance of filesystem manager ([IFsManager](#)). The filesystem manager supports notification of filesystem events like EFS restore indications.

##### Parameters

in	<i>callback</i>	Optional callback to get the initialization status of FsManager. <a href="#">telux::common::InitResponseCb</a>
----	-----------------	--

**Returns**

pointer of [IFsManager](#) object.

**4.43.1.1.1.3** `virtual std::shared_ptr<IDeviceInfoManager> telux::platform::PlatformFactory::get<↔  
DeviceInfoManager ( telux::common::InitResponseCb callback = nullptr ) [pure  
virtual]`

Get instance of device info manager ([IDeviceInfoManager](#)). The device info manager supports device info request like retrieving IMEI and platform version.

**Parameters**

in	<i>callback</i>	Optional callback to get the initialization status of FsManager. <a href="#">telux::common::InitResponseCb</a>
----	-----------------	--

**Returns**

pointer of [IDeviceInfoManager](#) object.

**4.43.1.1.1.4** `virtual std::shared_ptr<ITimeManager> telux::platform::PlatformFactory::getTimeManager  
( telux::common::InitResponseCb callback = nullptr ) [pure virtual]`

Gets a time manager ([ITimeManger](#)) instance. The time manager supports registering for time reports.

**Parameters**

in	<i>callback</i>	Optional callback to get the initialization status of <a href="#">ITimeManager</a> . <a href="#">telux::common::InitResponseCb</a>
----	-----------------	--

**Returns**

[ITimeManager](#) instance or nullptr if time management is not supported.

**4.43.1.1.1.5** `virtual std::shared_ptr<hardware::IAntennaManager> telux::platform::PlatformFactory<↔  
::getAntennaManager ( telux::common::InitResponseCb callback = nullptr ) [pure  
virtual]`

Gets an antenna manager ([IAntennaManager](#)) instance.

**Parameters**

in	<i>callback</i>	Optional callback to get the initialization status of antenna manager <a href="#">telux::common::InitResponseCb</a>
----	-----------------	---

**Returns**

[IAntennaManager](#) instance or nullptr if antenna management is not supported.



**Note**

Eval: This is a new API and is being evaluated. It is subject to change and could break backwards compatibility.\*

## 4.44 Filesystem

This section contains APIs, data structures and components to configure and acquire information from the filesystem manager.

### 4.44.1 Data Structure Documentation

#### 4.44.1.1 struct telux::platform::EfsEventInfo

##### Data fields

Type	Field	Description
<a href="#">EfsEvent</a>	event	The event being notified
ErrorCode	error	<a href="#">telux::common::ErrorCode</a> associated with the event

#### 4.44.1.2 class telux::platform::IFsListener

Listener class for getting notifications related to EFS backup/restore operations. The client needs to implement these methods as briefly as possible and avoid blocking calls in it. The methods in this class can be invoked from multiple different threads. Client needs to make sure that the implementation is thread-safe.

##### Public member functions

- virtual void [OnEfsRestoreEvent](#) ([EfsEventInfo](#) event)
- virtual void [OnEfsBackupEvent](#) ([EfsEventInfo](#) event)
- virtual void [OnFsOperationImminentEvent](#) (uint32\_t timeLeftToStart)
- virtual [~IFsListener](#) ()

##### 4.44.1.2.1 Constructors and Destructors

4.44.1.2.1.1 virtual [telux::platform::IFsListener::~~IFsListener](#) ( ) [[virtual](#)]

Destructor of [IFsListener](#)

##### 4.44.1.2.2 Member Function Documentation

4.44.1.2.2.1 virtual void [telux::platform::IFsListener::OnEfsRestoreEvent](#) ( [EfsEventInfo](#) event ) [[virtual](#)]

This function is called when a EFS restore operation is detected.

On platforms with Access control enabled, the client needs to have `TELUX_PLATFORM_LISTEN_FS_EVENTS` permission to receive this event.

**Parameters**

in	<i>event</i>	Event related data. <a href="#">telux::platform::EfsEventInfo</a> .
----	--------------	---

#### 4.44.1.2.2.2 virtual void telux::platform::IFsListener::OnEfsBackupEvent ( EfsEventInfo event ) [virtual]

This function is called when a EFS backup operation is detected.

On platforms with Access control enabled, the client needs to have TELUX\_PLATFORM\_LISTEN\_FS\_EVENTS permission to receive this event.

**Parameters**

in	<i>event</i>	Event related data. <a href="#">telux::platform::EfsEventInfo</a> .
----	--------------	---

#### 4.44.1.2.2.3 virtual void telux::platform::IFsListener::OnFsOperationImminentEvent ( uint32\_t timeLeftToStart ) [virtual]

When the client is about to make an eCall it is expected to invoke prepareForEcall. This starts a timer within the FsManager which represents the max duration of the eCall. After which the filesystem operations will resume. This API will be invoked to let the client know that resumption of Fs operations is imminent. If the eCall has not yet ended, the client should call prepareForEcall again to reset the timer, which will continue to suspend the FS operations.

**Parameters**

in	<i>timeLeftToStart</i>	The time in seconds after which filesystem operations shall re-enable.
----	------------------------	--

### 4.44.1.3 class telux::platform::IFsManager

[IFsManager](#) provides interface to to control and get notified about file system operations. This includes Embedded file system (EFS) operations.

**Public member functions**

- virtual [telux::common::ServiceStatus](#) getServiceStatus ()=0
- virtual [telux::common::Status](#) registerListener (std::weak\_ptr< [IFsListener](#) > listener)=0
- virtual [telux::common::Status](#) deregisterListener (std::weak\_ptr< [IFsListener](#) > listener)=0
- virtual [telux::common::Status](#) startEfsBackup ()=0
- virtual [telux::common::Status](#) prepareForEcall ()=0
- virtual [telux::common::Status](#) eCallCompleted ()=0
- virtual [telux::common::Status](#) prepareForOta ([OtaOperation](#) otaOperation, [telux::common::ResponseCallback](#) responseCb)=0

- virtual `telux::common::Status otaCompleted (OperationStatus operationStatus, telux::common::ResponseCallback responseCb)=0`
- virtual `telux::common::Status startAbSync (telux::common::ResponseCallback responseCb)=0`
- virtual `~IFsManager ()`

#### 4.44.1.3.1 Constructors and Destructors

4.44.1.3.1.1 virtual `telux::platform::IFsManager::~IFsManager ( ) [virtual]`

Destructor of `IFsManager`

#### 4.44.1.3.2 Member Function Documentation

4.44.1.3.2.1 virtual `telux::common::ServiceStatus telux::platform::IFsManager::getServiceStatus ( ) [pure virtual]`

This status indicates whether the object is in a usable state.

##### Returns

`telux::common::ServiceStatus` indicating the current status of the file system service.

4.44.1.3.2.2 virtual `telux::common::Status telux::platform::IFsManager::registerListener ( std::weak_ptr< IFsListener > listener ) [pure virtual]`

Registers the listener for FileSystem Manager indications.

##### Parameters

in	<i>listener</i>	- pointer to implemented listener.
----	-----------------	------------------------------------

##### Returns

status of the registration request.

4.44.1.3.2.3 virtual `telux::common::Status telux::platform::IFsManager::deregisterListener ( std::weak_ptr< IFsListener > listener ) [pure virtual]`

Deregisters the previously registered listener.

##### Parameters

in	<i>listener</i>	- pointer to registered listener that needs to be removed.
----	-----------------	--

##### Returns

status of the deregistration request.

#### 4.44.1.3.2.4 **virtual telux::common::Status telux::platform::IFsManager::startEfsBackup ( ) [pure virtual]**

Request to trigger an EFS backup. If the request is successful, the status of EFS backup is notified via [telux::platform::IFsListener::OnEfsBackupEvent](#).

On platforms with Access control enabled, Caller needs to have TELUX\_PLATFORM\_FS\_OPS\_CTRL permission to invoke this API successfully.

##### **Returns**

The status of the request - [telux::common::Status](#)

#### 4.44.1.3.2.5 **virtual telux::common::Status telux::platform::IFsManager::prepareForEcall ( ) [pure virtual]**

The Filesystem Manager performs periodic operations which might be resource intensive. Such operations are not desired during other crucial events like an eCall. To avoid performing such operations during such events, the client is recommended to invoke this API before it initiates an eCall. This allows the filesystem manager to prepare the system to restrict any resource intensive operations like filesystem scrubbing during the eCall.

On platforms with Access control enabled, Caller needs to have TELUX\_TEL\_ECALL\_MGMT permission to invoke this API successfully.

##### **Note**

- The client would need to periodically invoke this API to ensure that the timer gets reset so that operations do not get re-enabled.

##### **Returns**

- [telux::common::Status](#)

#### 4.44.1.3.2.6 **virtual telux::common::Status telux::platform::IFsManager::eCallCompleted ( ) [pure virtual]**

Once ecall complete, the client should invoke this API to re-enable filesystem operations like filesystem scrubbing. If the API invocation results in [telux::common::Status::NOTREADY](#), indicating that the sub-system is not ready, the client should retry.

On platforms with Access control enabled, Caller needs to have TELUX\_TEL\_ECALL\_MGMT permission to invoke this API successfully.

##### **Returns**

- [telux::common::Status](#)

#### 4.44.1.3.2.7 virtual telux::common::Status telux::platform::IFsManager::prepareForOta ( OtaOperation otaOperation, telux::common::ResponseCallback responseCb ) [pure virtual]

This API should be invoked to allow the filesystem manager to perform operations like prepare the filesystem for an OTA. In addition to this preparation, any on-going operations like scrubbing is stopped.

On platforms with Access control enabled, Caller needs to have TELUX\_PLATFORM\_OTA\_MGMT permission to invoke this API successfully.

##### Parameters

in	<i>otaOperation</i>	- <a href="#">telux::platform::OtaOperation</a> .
out	<i>responseCb</i>	- <a href="#">telux::common::ResponseCallback</a> The callback method to be invoked upon completion of OTA preparation and the response is indicated asynchronously.

##### Returns

- [telux::common::Status](#)

#### 4.44.1.3.2.8 virtual telux::common::Status telux::platform::IFsManager::otaCompleted ( Operation↔ Status operationStatus, telux::common::ResponseCallback responseCb ) [pure virtual]

This API should be invoked upon completion of OTA, this will allow the filesystem manager to perform post OTA verifications and re-enable operations that were disabled for performing the OTA, like scrubbing.

On platforms with Access control enabled, Caller needs to have TELUX\_PLATFORM\_OTA\_MGMT permission to invoke this API successfully.

##### Parameters

in	<i>operationStatus</i>	- <a href="#">telux::platform::OperationStatus</a> The status of the OTA operation that the client attempted.
out	<i>responseCb</i>	- <a href="#">telux::common::ResponseCallback</a> The callback method to be invoked upon completion of OTA related filesystem verifications and the response is indicated asynchronously.

##### Returns

- [telux::common::Status](#)

#### 4.44.1.3.2.9 virtual telux::common::Status telux::platform::IFsManager::startAbSync ( telux↔::common::ResponseCallback responseCb ) [pure virtual]

This API should be invoked when the client decides to mirror the active partition to the inactive partition.

On platforms with Access control enabled, Caller needs to have TELUX\_PLATFORM\_OTA\_MGMT permission to invoke this API successfully.

**Parameters**

out	<i>responseCb</i>	- <a href="#">telux::common::ResponseCallback</a> The callback method to be invoked when the mirroring operation is completed and the response is indicated asynchronously.
-----	-------------------	---

**Returns**

- [telux::common::Status](#)

**4.44.2 Enumeration Type Documentation****4.44.2.1 enum telux::platform::EfsEvent [strong]****Enumerator**

**START** Indicating the beginning of Backup/Restore operation

**END** Indicating the completion of Backup/Restore operation

**4.44.2.2 enum telux::platform::OperationStatus [strong]****Enumerator**

**UNKNOWN**

**SUCCESS**

**FAILURE**

**4.44.2.3 enum telux::platform::OtaOperation [strong]****Enumerator**

**INVALID**

**START**

**RESUME**

## 4.45 DeviceInfo

This section contains APIs related to device info management for retrieving IMEI and platform version.

### 4.45.1 Data Structure Documentation

#### 4.45.1.1 class telux::platform::IDeviceInfoListener

Listener class for getting device info related notifications . The client needs to implement these methods as briefly as possible and avoid blocking calls in it. The methods in this class can be invoked from multiple different threads. Client needs to make sure that the implementation is thread-safe.

##### Public member functions

- virtual [~IDeviceInfoListener](#) ()

##### 4.45.1.1.1 Constructors and Destructors

4.45.1.1.1.1 virtual [telux::platform::IDeviceInfoListener::~~IDeviceInfoListener](#) ( ) [virtual]

Destructor of [IDeviceInfoListener](#)

#### 4.45.1.2 struct telux::platform::PlatformVersion

Structure contains the version of the platform software

##### Data fields

Type	Field	Description
string	meta	Meta Version, for example: SA2150P_SA515M.LE_LE.1-3_2-1-00297-STD.INT-1
string	modem	Modem Version, for example: MPSS.HI.3.1.c3-00114-SDX55_GENAUTO_TEST-1
string	externalApp	External App Version, for example: LE.UM.3.2.3-72102-SA2150p.Int-1
string	integratedApp	Integrated App MDM Version, for example: LE.UM.4.1.1-71802-sa515m.Int-1

#### 4.45.1.3 class telux::platform::IDeviceInfoManager

[IDeviceInfoManager](#) provides interface to to retrieve IMEI and platform version operations.

##### Public member functions

- virtual [telux::common::ServiceStatus](#) [getServiceStatus](#) ()=0
- virtual [telux::common::Status](#) [registerListener](#) (std::weak\_ptr< [IDeviceInfoListener](#) > listener)=0
- virtual [telux::common::Status](#) [deregisterListener](#) (std::weak\_ptr< [IDeviceInfoListener](#) > listener)=0
- virtual [telux::common::Status](#) [getPlatformVersion](#) ([PlatformVersion](#) &pv)=0



- virtual [telux::common::Status](#) `getIMEI` (std::string &imei)=0
- virtual `~IDeviceInfoManager` ()

#### 4.45.1.3.1 Constructors and Destructors

4.45.1.3.1.1 virtual `telux::platform::IDeviceInfoManager::~IDeviceInfoManager` ( ) [virtual]

Destructor of [IDeviceInfoManager](#)

#### 4.45.1.3.2 Member Function Documentation

4.45.1.3.2.1 virtual `telux::common::ServiceStatus` `telux::platform::IDeviceInfoManager::getService`↔  
`Status` ( ) [pure virtual]

This status indicates whether the object is in a usable state.

##### Returns

[telux::common::ServiceStatus](#) indicating the current status of the device info service.

4.45.1.3.2.2 virtual `telux::common::Status` `telux::platform::IDeviceInfoManager::registerListener` ( `std::weak_ptr< IDeviceInfoListener > listener` ) [pure virtual]

Registers the listener for FileSystem Manager indications.

##### Parameters

in	<i>listener</i>	- pointer to implemented listener.
----	-----------------	------------------------------------

##### Returns

status of the registration request.

4.45.1.3.2.3 virtual `telux::common::Status` `telux::platform::IDeviceInfoManager::deregisterListener` ( `std::weak_ptr< IDeviceInfoListener > listener` ) [pure virtual]

Deregisters the previously registered listener.

##### Parameters

in	<i>listener</i>	- pointer to registered listener that needs to be removed.
----	-----------------	--

##### Returns

status of the deregistration request.

#### 4.45.1.3.2.4 virtual telux::common::Status telux::platform::IDeviceInfoManager::getPlatformVersion ( PlatformVersion & pv ) [pure virtual]

Get the platform version. On Hypervisor based platforms, on guest VM, only current application processor image is available, other images version data cannot be obtained.

##### Parameters

out	<i>pv</i>	- <a href="#">telux::platform::PlatformVersion</a>
-----	-----------	--

##### Returns

- [telux::common::Status](#)

#### 4.45.1.3.2.5 virtual telux::common::Status telux::platform::IDeviceInfoManager::getIMEI ( std::string & imei ) [pure virtual]

Get the international mobile equipment identity.

##### Parameters

out	<i>imei</i>	- std::string
-----	-------------	---------------

##### Returns

- [telux::common::Status](#)

## 4.46 Hardware Antenna

This section contains APIs related to antenna management to set or get the active antenna's configuration.

### 4.46.1 Data Structure Documentation

#### 4.46.1.1 class `telux::platform::hardware::IAntennaListener`

Listen class to get antenna configuration related notifications. The client needs to implement these methods as briefly as possible and avoid blocking calls. Class methods can be invoked from multiple threads, so the client needs to ensure that the implementation is thread-safe.

##### Public member functions

- virtual void `onActiveAntennaChange` (int `antIndex`)
- virtual `~IAntennaListener` ()

##### 4.46.1.1.1 Constructors and Destructors

4.46.1.1.1 virtual `telux::platform::hardware::IAntennaListener::~~IAntennaListener` ( ) [`virtual`]

`IAntennaListener` destructor.

##### 4.46.1.1.2 Member Function Documentation

4.46.1.1.2.1 virtual void `telux::platform::hardware::IAntennaListener::onActiveAntennaChange` ( int `antIndex` ) [`virtual`]

This function is called whenever any active cellular antenna is changed.

On platforms with access control enabled, the caller needs to have `TELUX_PLATFORM_ANTENNA_MGMT` permission to receive this notification.

##### Parameters

<code>in</code>	<code>antIndex</code>	Indicates which antenna is now active.
-----------------	-----------------------	--

##### Note

Eval: This is a new API and is being evaluated. It is subject to change and could break backwards compatibility.

#### 4.46.1.2 class `telux::platform::hardware::IAntennaManager`

`IAntennaManager` provides an interface to set and get the active antenna's configuration.

## Public member functions

- virtual [telux::common::ServiceStatus](#) `getServiceStatus ()=0`
- virtual [telux::common::Status](#) `registerListener (std::weak_ptr< IAntennaListener > listener)=0`
- virtual [telux::common::Status](#) `deregisterListener (std::weak_ptr< IAntennaListener > listener)=0`
- virtual [telux::common::Status](#) `setActiveAntenna (int antIndex, telux::common::ResponseCallback callback=nullptr)=0`
- virtual [telux::common::Status](#) `getActiveAntenna (GetActiveAntCb callback)=0`
- virtual [~IAntennaManager](#) ()

### 4.46.1.2.1 Constructors and Destructors

4.46.1.2.1.1 virtual [telux::platform::hardware::IAntennaManager::~IAntennaManager](#) ( ) [[virtual](#)]

[IAntennaManager](#) destructor.

### 4.46.1.2.2 Member Function Documentation

4.46.1.2.2.1 virtual [telux::common::ServiceStatus](#) [telux::platform::hardware::IAntennaManager::get](#)↔  
`ServiceStatus ( )` [[pure virtual](#)]

Indicates whether the object is in a usable state.

#### Returns

[telux::common::ServiceStatus](#) indicating the current status of the antenna configuration service.

4.46.1.2.2.2 virtual [telux::common::Status](#) [telux::platform::hardware::IAntennaManager::register](#)↔  
`Listener ( std::weak_ptr< IAntennaListener > listener )` [[pure virtual](#)]

Registers the listener for antenna manager indications.

#### Parameters

in	<i>listener</i>	Pointer to the implemented listener.
----	-----------------	--------------------------------------

#### Returns

Status of the registration request.

**4.46.1.2.2.3** `virtual telux::common::Status telux::platform::hardware::IAntennaManager↔  
::deregisterListener ( std::weak_ptr< IAntennaListener > listener ) [pure  
virtual]`

Deregisters the previously registered listener.

#### Parameters

in	<i>listener</i>	Pointer to the registered listener that needs to be removed.
----	-----------------	--

#### Returns

Status of the deregistration request.

**4.46.1.2.2.4** `virtual telux::common::Status telux::platform::hardware::IAntennaManager↔  
::setActiveAntenna ( int antIndex, telux::common::ResponseCallback callback = nullptr ) [pure  
virtual]`

Switches the cellular antenna configuration between antennas when an antenna is damaged. This API is to be invoked when the client detects that the currently active antenna is broken and determines that a switch to another antenna is required to maintain cellular services. The index of the antenna is based on the order in which the antenna appears in the radio frequency control (RFC). Across reboots or SSR, this configuration will not be persistent and it will reset back to the initial antenna. Clients are required to call this API again to switch to the desired antenna.

On platforms with access control enabled, the caller needs to have TELUX\_PLATFORM\_ANTENNA\_MGMT permission to successfully invoke this API.

#### Parameters

in	<i>antIndex</i>	Physical antenna switch path index to be set, this index starts with 0.
in	<i>callback</i>	Optional callback pointer to get the response of the setActiveAntenna request.

#### Returns

Status of the setActiveAntenna request; either success or the suitable error code.

#### Note

Eval: This is a new API and is being evaluated. It is subject to change and could break backwards compatibility.

#### 4.46.1.2.2.5 virtual telux::common::Status telux::platform::hardware::!AntennaManager::getActiveAntenna ( GetActiveAntCb *callback* ) [pure virtual]

Gets the current active cellular antenna configuration index of the device. Valid only when the device is camped on network.

On platforms with access control enabled, the caller needs to have TELUX\_PLATFORM\_ANTENNA\_MGMT permission to successfully invoke this API.

#### Parameters

in	<i>callback</i>	Callback function to get the getActiveAntenna response.
----	-----------------	---

#### Returns

Status of the getActiveAntenna request; either success or the suitable error code.

#### Note

Eval: This is a new API and is being evaluated. It is subject to change and could break backwards compatibility.

## 4.47 Time

This section contains APIs related to time management to register and deregister a listener for time reports.

### 4.47.1 Data Structure Documentation

#### 4.47.1.1 class `telux::platform::ITimeListener`

Listener class for getting time information. The client needs to implement these methods as briefly as possible and avoid blocking calls in it. The methods in this class can be invoked from multiple different threads. Client needs to make sure that the implementation is thread-safe.

##### Public member functions

- virtual void `onGnssUtcTimeUpdate` (const uint64\_t utcInMs)
- virtual void `onCv2xUtcTimeUpdate` (const uint64\_t utcInMs)
- virtual `~ITimeListener` ()

##### 4.47.1.1.1 Constructors and Destructors

###### 4.47.1.1.1.1 virtual `telux::platform::ITimeListener::~~ITimeListener` ( ) [`virtual`]

Destructor of `ITimeListener`

##### 4.47.1.1.2 Member Function Documentation

###### 4.47.1.1.2.1 virtual void `telux::platform::ITimeListener::onGnssUtcTimeUpdate` ( const uint64\_t *utcInMs* ) [`virtual`]

This function is called every 100 milliseconds after registering a listener by invoking `ITimeManager::registerListener`. The utc reported via this API is derived from location fix, utc value zero means there is no valid utc derived from location fix.

On platforms with Access control enabled, the client needs to have `TELUX_LOC_DATA` permission for this API to be invoked.

##### Parameters

out	<i>utcInMs</i>	- Milliseconds since Jan 1, 1970.
-----	----------------	-----------------------------------

###### 4.47.1.1.2.2 virtual void `telux::platform::ITimeListener::onCv2xUtcTimeUpdate` ( const uint64\_t *utcInMs* ) [`virtual`]

This function is called every second after registering a listener by invoking `ITimeManager::registerListener`. In order for this API to be invoked, the vehicle needs to be in an area of no GNSS coverage and select a roadside unit as the synchronization reference, and a client (like an ITS stack) needs to have injected a coarse UTC time using `telux::cv2x::ICv2xRadioManager::injectCoarseUtcTime`.

**Parameters**

out	<i>utcInMs</i>	- Milliseconds since Jan 1, 1970. 0 if no time available via SLSS (Sidelink Synchronisation Signal).
-----	----------------	--

**4.47.1.2 class telux::platform::ITimeManager**

[ITimeManager](#) provides interface to retrieve time information.

**Public member functions**

- virtual [telux::common::ServiceStatus](#) [getServiceStatus](#) ()=0
- virtual [telux::common::Status](#) [registerListener](#) (std::weak\_ptr< [ITimeListener](#) > listener, [TimeTypeMask](#) mask)=0
- virtual [telux::common::Status](#) [deregisterListener](#) (std::weak\_ptr< [ITimeListener](#) > listener, [TimeTypeMask](#) mask)=0
- virtual [~ITimeManager](#) ()

**4.47.1.2.1 Constructors and Destructors**

**4.47.1.2.1.1** virtual [telux::platform::ITimeManager::~ITimeManager](#) ( ) [**virtual**]

Destructor of [ITimeManager](#)

**4.47.1.2.2 Member Function Documentation**

**4.47.1.2.2.1** virtual [telux::common::ServiceStatus](#) [telux::platform::ITimeManager::getServiceStatus](#) ( ) [**pure virtual**]

This status indicates whether the object is in a usable state.

**Returns**

[telux::common::ServiceStatus](#) indicating the current status of the device info service.

**4.47.1.2.2.2** virtual [telux::common::Status](#) [telux::platform::ITimeManager::registerListener](#) ( **std::weak\_ptr< [ITimeListener](#) > *listener*, [TimeTypeMask](#) *mask*** ) [**pure virtual**]

Registers the listener for time updates. This will result in frequent notifications and will result in wakeups when system is suspended. If wakeups are not desired then deregister should be called.

**Parameters**

in	<i>listener</i>	- pointer to implemented listener.
in	<i>mask</i>	- mask to indicate which times the client is interested in registering for.



**Returns**

status of the registration request.

**4.47.1.2.2.3 virtual telux::common::Status telux::platform::!TimeManager::deregisterListener ( std::weak\_ptr< ITimeListener > *listener*, TimeTypeMask *mask* ) [pure virtual]**

Deregisters the previously registered listener for time updates.

**Parameters**

in	<i>listener</i>	- pointer to registered listener that needs to be removed.
in	<i>mask</i>	- mask to indicate which times the client has registering for.

**Returns**

status of the deregistration request.

**4.47.2 Enumeration Type Documentation****4.47.2.1 enum telux::platform::SupportedTimeType**

Defines supported utc report types.

**Enumerator**

***GNSS\_UTC\_TIME*** GNSS UTC time derived from location fix.

***CV2X\_UTC\_TIME*** UTC time derived from injected UTC when the vehicle has selected a roadside unit as the synchronization reference for V2X communication.

***MAX\_SUPPORTED\_TIME\_TYPES***

## 4.48 Security Management

This section contains APIs related to security management.

### 4.48.1 Data Structure Documentation

#### 4.48.1.1 struct telux::sec::LoadConfig

Specifies how load should be calculated.

##### Data fields

Type	Field	Description
uint64_t	calculation↔ Interval	

#### 4.48.1.2 struct telux::sec::CACapacity

Represents curve-wise absolute capacity. This value represents capacity as if only that type of curve is used in all crypto operations. For example, a capacity of 3000 for sm2 means, 3000 signature verifications of type sm2 can be done under current operating conditions, when no other type of verifications are performed.

##### Data fields

Type	Field	Description
uint32_t	sm2	
uint32_t	nist256	
uint32_t	nist384	
uint32_t	bp256	
uint32_t	bp384	

#### 4.48.1.3 struct telux::sec::CALoad

Represents curve-wise absolute load as calculated in the time window defined by [LoadConfig::calculationInterval](#). For example, a value of 1000 for sm2 means, in that time window, 1000 sm2 type verification were completed. This verification includes both passed and failed signature.

##### Data fields

Type	Field	Description
uint32_t	sm2	
uint32_t	nist256	
uint32_t	nist384	
uint32_t	bp256	
uint32_t	bp384	

#### 4.48.1.4 class telux::sec::ICAControlManagerListener

Receives load and capacity updates.

##### Public member functions

- virtual void [onCapacityUpdate](#) (struct [CACapacity](#) newCapacity)
- virtual void [onLoadUpdate](#) (struct [CALoad](#) currentLoad)
- virtual [~ICAControlManagerListener](#) ()

##### 4.48.1.4.1 Constructors and Destructors

**4.48.1.4.1.1** virtual telux::sec::ICAControlManagerListener::~~ICAControlManagerListener ( )  
[virtual]

Destructor for [ICAControlManagerListener](#).

##### 4.48.1.4.2 Member Function Documentation

**4.48.1.4.2.1** virtual void telux::sec::ICAControlManagerListener::onCapacityUpdate ( struct [CACapacity](#) *newCapacity* ) [virtual]

Invoked to provide an updated capacity.

##### Parameters

in	<i>newCapacity</i>	New capacity as per current allowed conditions.
----	--------------------	---

##### Note

Eval: This is a new API and is being evaluated. It is subject to change and could break backwards compatibility.

**4.48.1.4.2.2** virtual void telux::sec::ICAControlManagerListener::onLoadUpdate ( struct [CALoad](#) *currentLoad* ) [virtual]

Invoked to provide load on crypto accelerator, as observed during time window defined by [LoadConfig::calculationInterval](#).

##### Parameters

in	<i>currentLoad</i>	Load as observed in the set time window.
----	--------------------	--

##### Note

Eval: This is a new API and is being evaluated. It is subject to change and could break backwards compatibility.

### 4.48.1.5 class telux::sec::ICAControlManager

#### Public member functions

- virtual `telux::common::ErrorCode registerListener (std::weak_ptr< ICAControlManagerListener > listener)=0`
- virtual `telux::common::ErrorCode deRegisterListener (std::weak_ptr< ICAControlManagerListener > listener)=0`
- virtual `telux::common::ErrorCode startMonitoring (LoadConfig loadConfig)=0`
- virtual `telux::common::ErrorCode stopMonitoring ()=0`
- virtual `telux::common::ErrorCode getCapacity (CACapacity &capacity)=0`
- virtual `~ICAControlManager ()`

#### 4.48.1.5.1 Constructors and Destructors

##### 4.48.1.5.1.1 virtual telux::sec::ICAControlManager::~ICAControlManager ( ) [virtual]

Destructor of `ICAControlManager`. Cleans up as applicable.

#### 4.48.1.5.2 Member Function Documentation

##### 4.48.1.5.2.1 virtual telux::common::ErrorCode telux::sec::ICAControlManager::registerListener ( std::weak\_ptr< ICAControlManagerListener > listener ) [pure virtual]

Registers the given listener to get load and capacity updates in `ICAControlManagerListener::onLoadUpdate()` and `ICAControlManagerListener::onCapacityUpdate()` methods.

Capacity updates are received whenever capacity changes. Load updates are received as per parameters specified with `startMonitoring()`.

#### Parameters

in	<i>listener</i>	Receives load and capacity updates
----	-----------------	------------------------------------

#### Returns

`telux::common::Status::SUCCESS` if the listener is registered, otherwise, an appropriate error code

#### Note

Eval: This is a new API and is being evaluated. It is subject to change and could break backwards compatibility.

**4.48.1.5.2.2** `virtual telux::common::ErrorCode telux::sec::ICACControlManager::deRegisterListener ( std::weak_ptr< ICACControlManagerListener > listener ) [pure virtual]`

Unregisters the given listener registered previously with [registerListener\(\)](#).

#### Parameters

in	<i>listener</i>	Listener to deregister
----	-----------------	------------------------

#### Returns

[telux::common::Status::SUCCESS](#) if the listener is unregistered, otherwise, an appropriate error code

#### Note

Eval: This is a new API and is being evaluated. It is subject to change and could break backwards compatibility.

**4.48.1.5.2.3** `virtual telux::common::ErrorCode telux::sec::ICACControlManager::startMonitoring ( LoadConfig loadConfig ) [pure virtual]`

Starts monitoring and reporting load calculated based on the parameters specified. Calculated load is received by [ICACControlManagerListener::onLoadUpdate\(\)](#) periodically as per time interval specified.

On platforms with access control enabled, caller needs to have TELUX\_SEC\_CA\_CTRL\_LOAD\_OPS permission to invoke this API successfully.

#### Parameters

in	<i>loadConfig</i>	Defines load calculation parameters
----	-------------------	-------------------------------------

#### Returns

[telux::common::Status::SUCCESS](#) if the monitoring started, otherwise, an appropriate error code

#### Note

Eval: This is a new API and is being evaluated. It is subject to change and could break backwards compatibility.

#### 4.48.1.5.2.4 virtual telux::common::ErrorCode telux::sec::ICAControlManager::stopMonitoring ( ) [pure virtual]

Stops monitoring the load calculation previously started by [startMonitoring\(\)](#).

On platforms with access control enabled, caller needs to have TELUX\_SEC\_CA\_CTRL\_LOAD\_OPS permission to invoke this API successfully.

#### Returns

[telux::common::Status::SUCCESS](#) if the monitoring stopped, otherwise, an appropriate error code

#### Note

Eval: This is a new API and is being evaluated. It is subject to change and could break backwards compatibility.

#### 4.48.1.5.2.5 virtual telux::common::ErrorCode telux::sec::ICAControlManager::getCapacity ( CACapacity & capacity ) [pure virtual]

Provides current verification capacity of the crypto accelerator.

#### Parameters

out	<i>capacity</i>	current capacity of the crypto accelerator
-----	-----------------	--

#### Returns

[telux::common::Status::SUCCESS](#) if the capacity is fetched, otherwise, an appropriate error code

#### Note

Eval: This is a new API and is being evaluated. It is subject to change and could break backwards compatibility.

### 4.48.1.6 struct telux::sec::EnvironmentInfo

Describes an overall cellular environment's information.

#### Data fields

Type	Field	Description
<a href="#">Environment↔State</a>	environment↔State	Please refer <a href="#">EnvironmentState</a> for details.

### 4.48.1.7 struct telux::sec::CellularSecurityReport

Represents security scan report for a cellular connection per base station.

**Data fields**

Type	Field	Description
uint32_t	threatScore	The higher the score higher the possibility of a compromised/malicious base station. The range of valid values for the score is configurable in the platform. The default range is 0 to 500.
uint32_t	cellId	Unique identifier of a cell operated by a mobile network operator.
uint32_t	pid	Physical cell id; identifier of a cell in the physical layer of the cellular technology.
string	mcc	Mobile country code to uniquely identify a mobile network operator (carrier).
string	mnc	Mobile network code to uniquely identify a mobile network operator (carrier).
vector< <a href="#">Cellular↔ ThreatType</a> >	threats	Types of the threat identified. Please refer <a href="#">CellularThreatType</a> for more details.
<a href="#">ActionType</a>	actionType	Action taken based on the policy configured and threat score.
<a href="#">RATType</a>	rat	Radio access technology being used for communication between the device and the base station (2G/GERAN, 3G/WCDMA, 4G/LTE and 5G/NR).

**4.48.1.8 struct telux::sec::SessionStats**

For the current session, it represents a high-level summary of the security stats gathered till now. This gives an overall idea about the operational cellular environment.

This can be useful in cases for example, to decide whether a security sensitive operation should be deferred to a later time or place with less hostile environment or extra preventive measures should be activated.

**Data fields**

Type	Field	Description
uint32_t	reportsCount	Number of the reports received.
uint32_t	threshold↔ CrossedCount	Number of times hostile score threshold was crossed. This count depends on the value of the threshold configured in the platform. This count increments each time the threat score increases beyond this threshold.
vector< <a href="#">Cellular↔ ThreatType</a> >	threats	Different types of threats detected.
uint32_t	average↔ ThreatScore	An average score (average of <a href="#">CellularSecurityReport::threatScore</a> ).
<a href="#">ActionType</a>	lastAction	Last action that was taken based on the policy configured, when a malicious activity was detected.
bool	anyAction↔ Taken	Set to true, if an action was taken, when the score crossed hostile threshold.

#### 4.48.1.9 class telux::sec::ICellularScanReportListener

Receives security scan reports when a change in cellular environment is detected. For example;

1. Device connects to a given cell tower.
2. Device moves between different cell towers.
3. A new cellular base station is detected.
4. There is a change in the threat score beyond defined threshold.

##### Public member functions

- virtual void [onScanReportAvailable](#) ([CellularSecurityReport](#) report, [EnvironmentInfo](#) environmentInfo)
- virtual [~ICellularScanReportListener](#) ()

#### 4.48.1.9.1 Constructors and Destructors

**4.48.1.9.1.1 virtual telux::sec::ICellularScanReportListener::~~ICellularScanReportListener ( )**  
[virtual]

Destructor for [ICellularScanReportListener](#).

#### 4.48.1.9.2 Member Function Documentation

**4.48.1.9.2.1 virtual void telux::sec::ICellularScanReportListener::onScanReportAvailable ( CellularSecurityReport *report*, EnvironmentInfo *environmentInfo* )** [virtual]

Invoked to provide a security scan report for cellular connection environment.

##### Parameters

in	<i>report</i>	<a href="#">CellularSecurityReport</a> result of the cellular security scanning
in	<i>environmentInfo</i>	<a href="#">EnvironmentInfo</a> overall environment information

##### Note

Eval: This is a new API and is being evaluated. It is subject to change and could break backwards compatibility.



### 4.48.1.10 class telux::sec::ICellularSecurityManager

Provides support for detecting, monitoring and generating security threat scan report for cellular connections.

When a change in the cellular operating environment is detected, information about the environment is gathered and analyzed for targeted, general purpose attacks and anomalies. This information is then provided as a security scan report.

The report includes information such as, IMSI leak, tracking location of the device, denial of service, man-in-the-middle attack, spam or phishing SMS, fake emergency messages and rogue base stations.

#### Public member functions

- virtual [telux::common::ErrorCode registerListener](#) (std::weak\_ptr< [ICellularScanReportListener](#) > reportListener)=0
- virtual [telux::common::ErrorCode deRegisterListener](#) (std::weak\_ptr< [ICellularScanReportListener](#) > reportListener)=0
- virtual [telux::common::ErrorCode getCurrentSessionStats](#) ([SessionStats](#) &sessionStats)=0
- virtual [~ICellularSecurityManager](#) ()

#### 4.48.1.10.1 Constructors and Destructors

4.48.1.10.1.1 virtual [telux::sec::ICellularSecurityManager::~~ICellularSecurityManager](#) ( ) [[virtual](#)]

Destructor of [ICellularSecurityManager](#). Cleans up as applicable.

#### 4.48.1.10.2 Member Function Documentation

4.48.1.10.2.1 virtual [telux::common::ErrorCode telux::sec::ICellularSecurityManager::registerListener](#) ( std::weak\_ptr< [ICellularScanReportListener](#) > *reportListener* ) [[pure virtual](#)]

Registers given listener to receive cellular security scan report.

On platforms with access control enabled, caller needs to have TELUX\_SEC\_CCS\_REPORT permission to invoke this API successfully.

#### Parameters

in	<i>reportListener</i>	Receives security scan reports via <a href="#">ICellularScanReportListener::onScanReportAvailable()</a>
----	-----------------------	---

#### Returns

[telux::common::ErrorCode::SUCCESS](#), if the listener is registered, otherwise, an appropriate error code

**Note**

Eval: This is a new API and is being evaluated. It is subject to change and could break backwards compatibility.

**4.48.1.10.2.2** `virtual telux::common::ErrorCode telux::sec::ICellularSecurityManager::deRegisterListener ( std::weak_ptr< ICellularScanReportListener > reportListener ) [pure virtual]`

Unregisters the given listener registered previously with `registerListener()`.

On platforms with access control enabled, caller needs to have TELUX\_SEC\_CCS\_REPORT permission to invoke this API successfully.

**Parameters**

in	<i>reportListener</i>	Listener to unregister
----	-----------------------	------------------------

**Returns**

`telux::common::ErrorCode::SUCCESS`, if the listener is deregistered, otherwise, an appropriate error code

**Note**

Eval: This is a new API and is being evaluated. It is subject to change and could break backwards compatibility.

**4.48.1.10.2.3** `virtual telux::common::ErrorCode telux::sec::ICellularSecurityManager::getCurrentSessionStats ( SessionStats & sessionStats ) [pure virtual]`

Gets current session statistics such as average score, number of reports generated, and threat types detected etc.

A session starts when a listener is registered using `ICellularSecurityManager::registerListener` and ends when it is deregistered using `ICellularSecurityManager::deRegisterListener`.

On platforms with access control enabled, caller needs to have TELUX\_SEC\_CCS\_REPORT permission to invoke this API successfully.

**Parameters**

out	<i>sessionStats</i>	<code>SessionStats</code> will contain current session's stats upon method return
-----	---------------------	---

**Returns**

Status `telux::common::ErrorCode::SUCCESS`, if the stats are fetched successfully, otherwise, an appropriate error code

**Note**

Eval: This is a new API and is being evaluated. It is subject to change and could break backwards compatibility.

**4.48.1.11 class telux::sec::ConnectionSecurityFactory**

ConnectionSecurityFactory allows creation of CellularSecurityManager and WiFiSecurityManager.

**Public member functions**

- virtual std::shared\_ptr< ICellularSecurityManager > getCellularSecurityManager (telux::common::ErrorCode &ec)=0
- virtual std::shared\_ptr< IWiFiSecurityManager > getWiFiSecurityManager (telux::common::ErrorCode &ec)=0

**Static Public Member Functions**

- static ConnectionSecurityFactory & getInstance ()

**4.48.1.11.1 Member Function Documentation****4.48.1.11.1.1 static ConnectionSecurityFactory& telux::sec::ConnectionSecurityFactory::getInstance ( ) [static]**

Gets the ConnectionSecurityFactory instance.

**4.48.1.11.1.2 virtual std::shared\_ptr<ICellularSecurityManager> telux::sec::ConnectionSecurityFactory::getCellularSecurityManager ( telux::common::ErrorCode & ec ) [pure virtual]**

Provides an ICellularSecurityManager instance that detects and monitors security threats and generates security scan reports for cellular connections.

**Parameters**

out	ec	telux::common::ErrorCode::SUCCESS if ICellularSecurityManager is created successfully, otherwise, an appropriate error code
-----	----	---

**Returns**

ICellularSecurityManager instance or nullptr, if an error occurred

**Note**

Eval: This is a new API and is being evaluated. It is subject to change and could break backwards compatibility.

**4.48.1.11.1.3** `virtual std::shared_ptr<IWiFiSecurityManager> telux::sec::ConnectionSecurityFactory::getWiFiSecurityManager ( telux::common::ErrorCode & ec ) [pure virtual]`

Provides an [IWiFiSecurityManager](#) instance that detects and monitors security threats and generates security analysis reports for WiFi connections.

#### Parameters

out	ec	<a href="#">telux::common::ErrorCode::SUCCESS</a> if <a href="#">IWiFiSecurityManager</a> is created successfully, otherwise, an appropriate error code
-----	----	---

#### Returns

[IWiFiSecurityManager](#) instance or nullptr, if an error occurred

#### Note

Eval: This is a new API and is being evaluated. It is subject to change and could break backwards compatibility.

### 4.48.1.12 struct telux::sec::ECCPoint

Represents a point on an elliptic curve.

#### Data fields

Type	Field	Description
uint8_t *	x	
size_t	xLength	
uint8_t *	y	
size_t	yLength	

### 4.48.1.13 struct telux::sec::DataDigest

Represents digest of the data whose signature is to be verified.

#### Data fields

Type	Field	Description
uint8_t *	digest	
size_t	digestLength	

### 4.48.1.14 struct telux::sec::Signature

Represents signature of the digest to be verified.

**Data fields**

Type	Field	Description
uint8_t *	rSignature	
uint8_t *	sSignature	
size_t	rsLength	

**4.48.1.15 struct telux::sec::Scalar**

Represents scalar value to be used with an ECQV operation.

**Data fields**

Type	Field	Description
uint8_t *	scalar	
size_t	scalarLength	

**4.48.1.16 struct telux::sec::OperationResult**

Represents a result obtained from the crypto accelerator. The value of an individual field must only be interpreted through helper methods in [ResultParser](#).

**Data fields**

Type	Field	Description
uint32_t	reserved:4	
uint32_t	id:12	
uint32_t	operation↔ Type:3	
uint32_t	result:4	
uint32_t	errCode:9	
uint8_t	data[CA_RE↔ SULT_DAT↔ A_LENGTH]	

**4.48.1.17 class telux::sec::ICryptoAcceleratorListener**

Receives ECC signature verification and ECQV calculation result.

**Public member functions**

- virtual void [onVerificationResult](#) (uint32\_t uniqueId, [telux::common::ErrorCode](#) errorCode, std::vector< uint8\_t > resultData)
- virtual void [onCalculationResult](#) (uint32\_t uniqueId, [telux::common::ErrorCode](#) errorCode, std::vector< uint8\_t > resultData)
- virtual [~ICryptoAcceleratorListener](#) ()

#### 4.48.1.17.1 Constructors and Destructors

4.48.1.17.1.1 `virtual telux::sec::ICryptoAcceleratorListener::~~ICryptoAcceleratorListener ( )`  
`[virtual]`

Destructor for [ICryptoAcceleratorListener](#).

#### 4.48.1.17.2 Member Function Documentation

4.48.1.17.2.1 `virtual void telux::sec::ICryptoAcceleratorListener::onVerificationResult ( uint32_t`  
`uniqueId, telux::common::ErrorCode errorCode, std::vector< uint8_t > resultData )`  
`[virtual]`

Invoked to provide an ECC signature verification result.

##### Parameters

in	<i>uniqueId</i>	Unique request identifier. This is the same as what was passed to <a href="#">ICryptoAcceleratorManager::eccPostDigestForVerification()</a>
in	<i>errorCode</i>	<a href="#">telux::common::ErrorCode::SUCCESS</a> , if signature passed validation, <a href="#">telux::common::ErrorCode::VERIFICATION_FAILED</a> if all inputs were correct, verification completed and signature was invalid, an appropriate error code in all other cases
in	<i>resultData</i>	Contains the r' (computed r-component of the signature)

4.48.1.17.2.2 `virtual void telux::sec::ICryptoAcceleratorListener::onCalculationResult ( uint32_t`  
`uniqueId, telux::common::ErrorCode errorCode, std::vector< uint8_t > resultData )`  
`[virtual]`

Invoked to provide an ECQV calculation result.

##### Parameters

in	<i>uniqueId</i>	Unique request identifier. This is the same as what was passed to <a href="#">ICryptoAcceleratorManager::ecqvPostDataForMultiply←AndAdd()</a>
in	<i>errorCode</i>	<a href="#">telux::common::ErrorCode::SUCCESS</a> , if calculation succeeded, otherwise, an appropriate error code
in	<i>resultData</i>	Output point Q (Q=kP+A). For <a href="#">CURVE_SM2</a> , <a href="#">CURVE_NISTP256</a> and <a href="#">CURVE_BRAINPOOLP256R1</a> , byte from 0 to 31 contains x-coordinate, and byte from 32 to 63 contains y-coordinate. For <a href="#">CURVE_NISTP384</a> and <a href="#">CURVE_BRAINPOOLP384R1</a> , byte from 0 to 47 contains x-coordinate, and byte from 48 to 95 contains y-coordinate.

#### 4.48.1.18 class telux::sec::ICryptoAcceleratorManager

Provides support for ECC based signature verification and calculation related crypto operations.

APIs with asynchronous and synchronous semantics are provided for the same operation, providing flexibility to optimally support multiple client solutions.

Clients that prefer to invoke verifications from a thread and consume the results on a different thread should use the asynchronous APIs. Clients that prefer to invoke verification APIs and block until the result is ready, should use the synchronous APIs.

##### Public member functions

- virtual `telux::common::ErrorCode eccPostDigestForVerification` (const `DataDigest` &digest, const `ECCPoint` &publicKey, const `Signature` &signature, `telux::sec::ECCCurve` curve, `uint32_t` uniqueId, `telux::sec::RequestPriority` priority)=0
- virtual `telux::common::ErrorCode ecqvPostDataForMultiplyAndAdd` (const `ECCPoint` &multiplicandPoint, const `ECCPoint` &addendPoint, const `Scalar` &scalar, `telux::sec::ECCCurve` curve, `uint32_t` uniqueId, `telux::sec::RequestPriority` priority)=0
- virtual `telux::common::ErrorCode getAsyncResults` (std::vector< `OperationResult` > &results, `uint32_t` numResultsToRead, `int32_t` timeout, `uint32_t` &numResultsRead)=0
- virtual `telux::common::ErrorCode eccVerifyDigest` (const `DataDigest` &digest, const `ECCPoint` &publicKey, const `Signature` &signature, `telux::sec::ECCCurve` curve, `uint32_t` uniqueId, `telux::sec::RequestPriority` priority, std::vector< `uint8_t` > &resultData)=0
- virtual `telux::common::ErrorCode ecqvPointMultiplyAndAdd` (const `ECCPoint` &multiplicandPoint, const `ECCPoint` &addendPoint, const `Scalar` &scalar, `telux::sec::ECCCurve` curve, `uint32_t` uniqueId, `telux::sec::RequestPriority` priority, std::vector< `uint8_t` > &resultData)=0
- virtual `~ICryptoAcceleratorManager` ()

##### 4.48.1.18.1 Constructors and Destructors

4.48.1.18.1.1 `virtual telux::sec::ICryptoAcceleratorManager::~ICryptoAcceleratorManager ( )`  
[`virtual`]

Destructor of `ICryptoAcceleratorManager`. Cleans up as applicable.

##### 4.48.1.18.2 Member Function Documentation

4.48.1.18.2.1 `virtual telux::common::ErrorCode telux::sec::ICryptoAcceleratorManager::eccPostDigestForVerification ( const DataDigest & digest, const ECCPoint & publicKey, const Signature & signature, telux::sec::ECCCurve curve, uint32_t uniqueId, telux::sec::RequestPriority priority )` [`pure virtual`]

Sends hashed ECC data to the crypto accelerator for integrity verification using the given public key and signature.

Verification result is received by the `ICryptoAcceleratorListener::onVerificationResult()` method for `MODE_ASYNC_LISTENER`. For `MODE_ASYNC_POLL`, `getAsyncResults()` is used to obtain the results.

**Parameters**

in	<i>digest</i>	Digest of data
in	<i>publicKey</i>	Uncompressed public key used to verify the signature
in	<i>signature</i>	<a href="#">Signature</a> of the digest
in	<i>curve</i>	ECC curve on which given public key lies
in	<i>uniqueId</i>	Unique identifier for each request. This number must be unique across all requests for which results are pending. Once the result for a request is received, the same number can be reused. Valid value range is $0 \leq \text{uniqueId} \leq 4095$ .
in	<i>priority</i>	Relative priority indicating this digest should be verified before any other low priority digest

**Returns**

[telux::common::ErrorCode::SUCCESS](#), if the data is sent to the accelerator, otherwise an appropriate error code

**4.48.1.18.2.2** `virtual telux::common::ErrorCode telux::sec::ICryptoAcceleratorManager::ecqvPost←DataForMultiplyAndAdd ( const ECCPoint & multiplicandPoint, const ECCPoint & addendPoint, const Scalar & scalar, telux::sec::ECCCurve curve, uint32_t uniqueId, telux::sec::RequestPriority priority ) [pure virtual]`

Sends data to the crypto accelerator to perform a point multiplication and addition for 'Short Weierstrass' curves;  $Q=kP+A$ .

Calculation result is received by the [ICryptoAcceleratorListener::onCalculationResult\(\)](#) method for [MODE\\_ASYNC\\_LISTENER](#). For [MODE\\_ASYNC\\_POLL](#), [getAsyncResults\(\)](#) is used to obtain the results.

**Parameters**

in	<i>multiplicandPoint</i>	Point to multiply (P). In context of public key reconstruction, it represents the reconstruction value
in	<i>addendPoint</i>	Point to add (A). In context of public key reconstruction, it represents the CA public key
in	<i>scalar</i>	<a href="#">Scalar</a> for the scalar multiplication (k). In context of public key reconstruction, it represents the hash construct
in	<i>curve</i>	ECC curve associated with point P and A
in	<i>uniqueId</i>	Unique identifier for each request. This number must be unique across all requests for which results are pending. Once the result for a request is received, the the same number can be reused. Valid value range is $0 \leq \text{uniqueId} \leq 4095$ .
in	<i>priority</i>	Relative priority indicating this calculation should be performed before any other low priority operation

**Returns**

[telux::common::ErrorCode::SUCCESS](#), if the data is sent to the accelerator, otherwise an appropriate error code



**4.48.1.18.2.3** virtual `telux::common::ErrorCode telux::sec::ICryptoAcceleratorManager::getAsync`↔  
**Results** ( `std::vector< OperationResult > & results`, `uint32_t numResultsToRead`, `int32_t timeout`, `uint32_t & numResultsRead` ) [pure virtual]

When using `Mode::MODE_ASYNC_POLL`, `ICryptoAcceleratorManager::eccPostDigestForVerification()` and `ICryptoAcceleratorManager::ecqvPostDataForMultiplyAndAdd()` APIs are used to send request.

The result of these request is obtained asynchronously using this method. It blocks until result(s) is available or timeout occurs.

Caller should allocate sufficient memory pointed by 'results'.

#### Parameters

out	<i>results</i>	Buffer that will contain the results
in	<i>numResultsToRead</i>	Number of the results to read
in	<i>timeout</i>	Time to wait (in milliseconds) for the result(s). Specifying a negative value means an infinite timeout. Zero value means return immediately (there may or may not be any results read).
out	<i>numResultsRead</i>	Number of results actually read

#### Returns

`telux::common::ErrorCode::SUCCESS`, if the result(s) are obtained successfully, otherwise an appropriate error code

**4.48.1.18.2.4** virtual `telux::common::ErrorCode telux::sec::ICryptoAcceleratorManager::eccVerify`↔  
**Digest** ( `const DataDigest & digest`, `const ECCPoint & publicKey`, `const Signature & signature`, `telux::sec::ECCCurve curve`, `uint32_t uniqueId`, `telux::sec::RequestPriority priority`, `std::vector< uint8_t > & resultData` ) [pure virtual]

Verifies the signature of the digest using given public key.

#### Parameters

in	<i>digest</i>	Digest of data
in	<i>publicKey</i>	Uncompressed public key used to verify the signature
in	<i>signature</i>	<a href="#">Signature</a> of the digest
in	<i>curve</i>	ECC curve on which given public key lies
in	<i>uniqueId</i>	Unique identifier for each request. This number must be unique across all requests for which results are pending. Once the result for a request is received, the same number can be reused. Valid value range is $0 \leq \text{uniqueId} \leq 4095$ .
in	<i>priority</i>	Relative priority indicating this digest should be verified before any other low priority digest
out	<i>resultData</i>	Contains the r' prime (computed r-component of the signature)

#### Returns

`telux::common::ErrorCode::SUCCESS`, if signature passed validation,

[telux::common::ErrorCode::VERIFICATION\\_FAILED](#) if all inputs were correct, verification completed and signature was invalid, an appropriate error code in all other cases

**4.48.1.18.2.5 virtual `telux::common::ErrorCode telux::sec::ICryptoAcceleratorManager::ecqv↔ PointMultiplyAndAdd ( const ECCPoint & multiplicandPoint, const ECCPoint & addendPoint, const Scalar & scalar, telux::sec::ECCCurve curve, uint32_t uniqueId, telux::sec::RequestPriority priority, std::vector< uint8_t > & resultData ) [pure virtual]`**

Performs a point multiplication and addition for 'Short Weierstrass' curves;  $Q=kP+A$  with the help of accelerator. This can be used, for example; to reconstruct a public key, using 'Elliptic Curve Qu-Vanstone (ECQV)' implicit certificate scheme.

#### Parameters

in	<i>multiplicandPoint</i>	Point to multiply (P). In context of public key reconstruction, it represents the reconstruction value
in	<i>addendPoint</i>	Point to add (A). In context of public key reconstruction, it represents the CA public key
in	<i>scalar</i>	<a href="#">Scalar</a> for the scalar multiplication (k). In context of public key reconstruction, it represents the hash construct
in	<i>curve</i>	ECC curve associated with point P and A
in	<i>uniqueId</i>	Unique identifier for each request. This number must be unique across all requests for which results are pending. Once the result for a request is received, the the same number can be reused. Valid value range is $0 \leq \text{uniqueId} \leq 4095$ .
in	<i>priority</i>	Relative priority indicating this calculation should be performed before any other low priority operation
out	<i>resultData</i>	Output point Q ( $Q=kP+A$ ). For <a href="#">CURVE_SM2</a> , <a href="#">CURVE_NISTP256</a> and <a href="#">CURVE_BRAINPOOLP256R1</a> , byte from 0 to 31 contains x-coordinate, and byte from 32 to 63 contains y-coordinate. For <a href="#">CURVE_NISTP384</a> and <a href="#">CURVE_BRAINPOOLP384R1</a> , byte from 0 to 47 contains x-coordinate, and byte from 48 to 95 contains y-coordinate.

#### Returns

[telux::common::ErrorCode::SUCCESS](#), if the calculation succeeded, otherwise an appropriate error code

#### 4.48.1.19 class `telux::sec::ResultParser`

Provides helpers to parse fields in the [OperationResult](#).

#### Static Public Member Functions

- static `uint32_t getId` (const [OperationResult](#) &result)
- static `OperationType getOperationType` (const [OperationResult](#) &result)

- static [telux::common::ErrorCode](#) [getErrorCode](#) (const [OperationResult](#) &result)
- static [telux::common::ErrorCode](#) [getCAErrorCode](#) (const [OperationResult](#) &result)
- static [uint8\\_t\\*](#) [getData](#) ([OperationResult](#) &result)

#### 4.48.1.19.1 Member Function Documentation

##### 4.48.1.19.1.1 static [uint32\\_t](#) [telux::sec::ResultParser::getId](#) ( const [OperationResult](#) & *result* ) [static]

Gets the unique identifier associated with the result.

#### Parameters

in	<i>result</i>	Result obtained from <a href="#">ICryptoAcceleratorManager::getAsyncResults()</a>
----	---------------	---

#### Returns

Unique identifier associated with the result. This is the same as what was passed in request

##### 4.48.1.19.1.2 static [OperationType](#) [telux::sec::ResultParser::getOperationType](#) ( const [OperationResult](#) & *result* ) [static]

Gets the type of operation corresponding to this result; values are and [OperationType::OP\\_TYPE\\_VERIFY](#) and [OperationType::OP\\_TYPE\\_CALCULATE](#).

#### Parameters

in	<i>result</i>	Result obtained from <a href="#">ICryptoAcceleratorManager::getAsyncResults()</a>
----	---------------	---

#### Returns

Operation type - [OperationType::OP\\_TYPE\\_VERIFY](#) for signature verification, [OperationType::OP\\_TYPE\\_CALCULATE](#) for point calculation.

##### 4.48.1.19.1.3 static [telux::common::ErrorCode](#) [telux::sec::ResultParser::getErrorCode](#) ( const [OperationResult](#) & *result* ) [static]

Indicates if the operation passed.

#### Parameters

in	<i>result</i>	Result obtained from <a href="#">ICryptoAcceleratorManager::getAsyncResults()</a>
----	---------------	---

**Returns**

For ECC verification, [telux::common::ErrorCode::SUCCESS](#), if signature passed validation, [telux::common::ErrorCode::VERIFICATION\\_FAILED](#) if all inputs were correct, verification completed and signature was invalid, an appropriate error code in all other cases. For ECQV calculation, [telux::common::ErrorCode::SUCCESS](#), if the calculation succeeded, an appropriate error code in all other cases

#### 4.48.1.19.1.4 **static telux::common::ErrorCode telux::sec::ResultParser::getCAErrorCode ( const OperationResult & result ) [static]**

Provides a crypto accelerator hardware specific error code to further identify the actual error. Should be used only if [getErrorCode\(\)](#) indicates an error occurred.

**Parameters**

<i>in</i>	<i>result</i>	Result obtained from <a href="#">ICryptoAcceleratorManager::getAsyncResults()</a>
-----------	---------------	---

**Returns**

Error code - [telux::common::ErrorCode::\\*](#) as obtained from the accelerator

#### 4.48.1.19.1.5 **static uint8\_t\* telux::sec::ResultParser::getData ( OperationResult & result ) [static]**

Gets the actual result data. For ECC verification, it contains r-prime and for ECQV it contains coordinates.

**Parameters**

<i>in</i>	<i>result</i>	Result obtained from <a href="#">ICryptoAcceleratorManager::getAsyncResults()</a>
-----------	---------------	---

**Returns**

Pointer to the data, For ECC verification contains r-prime, For ECQV calculation contains coordinates

#### 4.48.1.20 **class telux::sec::ICryptoParam**

Specifies how a crypto operation should be performed. An instance of this must be created only through [CryptoParamBuilder](#).

**Public member functions**

- virtual [~ICryptoParam \(\)](#)

#### 4.48.1.20.1 **Constructors and Destructors**

#### 4.48.1.20.1.1 virtual telux::sec::ICryptoParam::~~ICryptoParam ( ) [virtual]

#### 4.48.1.21 struct telux::sec::EncryptedData

Represents encrypted data and optional nonce.

##### Data fields

Type	Field	Description
vector< uint8↔ _t >	encryptedText	Encrypted text.
vector< uint8↔ _t >	nonce	Generated nonce.

#### 4.48.1.22 class telux::sec::ICryptoManager

[ICryptoManager](#) provides key management and crypto operation support. It uses trusted hardware bound cryptography. All keys generated are bound to the device cryptographically.

##### Public member functions

- virtual [telux::common::ErrorCode generateKey](#) (std::shared\_ptr< [ICryptoParam](#) > cryptoParam, std::vector< uint8\_t > &keyBlob)=0
- virtual [telux::common::ErrorCode importKey](#) (std::shared\_ptr< [ICryptoParam](#) > cryptoParam, [telux::sec::KeyFormat](#) keyFmt, std::vector< uint8\_t > const &keyData, std::vector< uint8\_t > &keyBlob)=0
- virtual [telux::common::ErrorCode exportKey](#) ([telux::sec::KeyFormat](#) keyFmt, std::vector< uint8\_t > const &keyBlob, std::vector< uint8\_t > &keyData)=0
- virtual [telux::common::ErrorCode upgradeKey](#) (std::shared\_ptr< [ICryptoParam](#) > cryptoParam, std::vector< uint8\_t > const &oldKeyBlob, std::vector< uint8\_t > &newKeyBlob)=0
- virtual [telux::common::ErrorCode signData](#) (std::shared\_ptr< [ICryptoParam](#) > cryptoParam, std::vector< uint8\_t > const &keyBlob, std::vector< uint8\_t > const &plainText, std::vector< uint8\_t > &signature)=0
- virtual [telux::common::ErrorCode verifyData](#) (std::shared\_ptr< [ICryptoParam](#) > cryptoParam, std::vector< uint8\_t > const &keyBlob, std::vector< uint8\_t > const &plainText, std::vector< uint8\_t > const &signature)=0
- virtual [telux::common::ErrorCode encryptData](#) (std::shared\_ptr< [ICryptoParam](#) > cryptoParam, std::vector< uint8\_t > const &keyBlob, std::vector< uint8\_t > const &plainText, std::shared\_ptr< [EncryptedData](#) > &encryptedData)=0
- virtual [telux::common::ErrorCode decryptData](#) (std::shared\_ptr< [ICryptoParam](#) > cryptoParam, std::vector< uint8\_t > const &keyBlob, std::vector< uint8\_t > const &encryptedText, std::vector< uint8\_t > &decryptedText)=0
- virtual [~ICryptoManager](#) ()

### 4.48.1.22.1 Constructors and Destructors

#### 4.48.1.22.1.1 virtual telux::sec::~ICryptoManager::~~ICryptoManager ( ) [virtual]

Destroys the [ICryptoManager](#) instance. Performs cleanup as applicable.

### 4.48.1.22.2 Member Function Documentation

#### 4.48.1.22.2.1 virtual telux::common::ErrorCode telux::sec::~ICryptoManager::generateKey ( std::shared\_ptr< ICryptoParam > *cryptoParam*, std::vector< uint8\_t > & *keyBlob* ) [pure virtual]

Generates key and provides it in the form of a corresponding key blob. The key's secret is encrypted in this key blob.

On platforms with access control enabled, the caller needs to have TELUX\_SEC\_KEY\_OPS permission to successfully invoke this API.

#### Parameters

in	<i>cryptoParam</i>	Specifications of the key.
out	<i>keyBlob</i>	Key blob representing the key.

#### Returns

[telux::common::ErrorCode](#) as appropriate.

#### Note

Eval: This is a new API and is being evaluated. It is subject to change and could break backwards compatibility.

#### 4.48.1.22.2.2 virtual telux::common::ErrorCode telux::sec::~ICryptoManager::importKey ( std::shared\_ptr< ICryptoParam > *cryptoParam*, telux::sec::KeyFormat *keyFmt*, std::vector< uint8\_t > & *keyData*, std::vector< uint8\_t > & *keyBlob* ) [pure virtual]

Creates a key blob from the given key data.

On platforms with access control enabled, the caller needs to have TELUX\_SEC\_KEY\_OPS permission to successfully invoke this API.

#### Parameters

in	<i>cryptoParam</i>	Specifications of the key
in	<i>keyFmt</i>	Format in which the key should be imported ( <a href="#">KeyFormat</a> )
in	<i>keyData</i>	Key's data, in the specified format, to be imported.
out	<i>keyBlob</i>	Key blob created from the given key data.

**Returns**

[telux::common::ErrorCode](#) as appropriate.

**Note**

Eval: This is a new API and is being evaluated. It is subject to change and could break backwards compatibility.

**4.48.1.22.2.3** `virtual telux::common::ErrorCode telux::sec::ICryptoManager::exportKey ( telux::sec::KeyFormat keyFmt, std::vector< uint8_t > const & keyBlob, std::vector< uint8_t > & keyData ) [pure virtual]`

Generates equivalent key data from the given key blob.

On platforms with access control enabled, the caller needs to have TELUX\_SEC\_KEY\_OPS permission to successfully invoke this API.

**Parameters**

in	<i>keyFmt</i>	<a href="#">KeyFormat</a> Format in which key should be exported.
in	<i>keyBlob</i>	Key blob representing the key to be exported.
out	<i>keyData</i>	Key's data generated from the given key blob.

**Returns**

[telux::common::ErrorCode](#) as appropriate.

**Note**

Eval: This is a new API and is being evaluated. It is subject to change and could break backwards compatibility.

**4.48.1.22.2.4** `virtual telux::common::ErrorCode telux::sec::ICryptoManager::upgradeKey ( std::shared_ptr< ICryptoParam > cryptoParam, std::vector< uint8_t > const & oldKeyBlob, std::vector< uint8_t > & newKeyBlob ) [pure virtual]`

Upgrades the given key if it has expired. For example, This API can be used when a key has expired due to a system software upgrade.

On platforms with access control enabled, the caller needs to have TELUX\_SEC\_KEY\_OPS permission to successfully invoke this API.

**Parameters**

in	<i>cryptoParam</i>	Input parameters passed to the upgrade algorithm. Specifically, unique data should be set if it was used when the key was originally created.
in	<i>oldKeyBlob</i>	Key blob representing the key to be upgraded.
out	<i>newKeyBlob</i>	Key blob representing the upgraded key.

**Returns**

[telux::common::ErrorCode](#) as appropriate.

**Note**

Eval: This is a new API and is being evaluated. It is subject to change and could break backwards compatibility.

**4.48.1.22.2.5** `virtual telux::common::ErrorCode telux::sec::ICryptoManager::signData ( std::shared_ptr< ICryptoParam > cryptoParam, std::vector< uint8_t > const & keyBlob, std::vector< uint8_t > const & plainText, std::vector< uint8_t > & signature ) [pure virtual]`

Generates a signature to verify the integrity of the given data.

On platforms with access control enabled, the caller needs to have TELUX\_SEC\_SIGN\_OPS permission to successfully invoke this API.

**Parameters**

in	<i>cryptoParam</i>	Input parameters passed to the signature generation algorithm.
in	<i>keyBlob</i>	Key blob to sign given data.
in	<i>plainText</i>	Data to be signed.
out	<i>signature</i>	<a href="#">Signature</a> generated for the given data.

**Returns**

[telux::common::ErrorCode](#) as appropriate.

**Note**

Eval: This is a new API and is being evaluated. It is subject to change and could break backwards compatibility.

**4.48.1.22.2.6** `virtual telux::common::ErrorCode telux::sec::ICryptoManager::verifyData ( std::shared_ptr< ICryptoParam > cryptoParam, std::vector< uint8_t > const & keyBlob, std::vector< uint8_t > const & plainText, std::vector< uint8_t > const & signature ) [pure virtual]`

Verifies integrity of the given data through its signature.

On platforms with access control enabled, the caller needs to have TELUX\_SEC\_SIGN\_OPS permission to successfully invoke this API.

**Parameters**

in	<i>cryptoParam</i>	Input parameters passed to the signature validation algorithm.
in	<i>keyBlob</i>	Key blob to verify the given data.
in	<i>plainText</i>	Data to be verified.
in	<i>signature</i>	<a href="#">Signature</a> of the data.



**Returns**

[telux::common::ErrorCode::SUCCESS](#) if verification is passed otherwise [telux::common::ErrorCode](#) as appropriate.

**Note**

Eval: This is a new API and is being evaluated. It is subject to change and could break backwards compatibility.

**4.48.1.22.2.7** `virtual telux::common::ErrorCode telux::sec::ICryptoManager::encryptData ( std::shared_ptr< ICryptoParam > cryptoParam, std::vector< uint8_t > const & keyBlob, std::vector< uint8_t > const & plainText, std::shared_ptr< EncryptedData > & encryptedData ) [pure virtual]`

Encrypts data per the given inputs to the encryption algorithm.

On platforms with access control enabled, the caller needs to have TELUX\_SEC\_ENCRYPTION\_OPS permission to successfully invoke this API.

**Parameters**

in	<i>cryptoParam</i>	Input parameters passed to the encryption algorithm.
in	<i>keyBlob</i>	Key blob to be used for encryption.
in	<i>plainText</i>	Data to be encrypted.
out	<i>encryptedData</i>	Encrypted data and nonce, if <a href="#">CryptoParamBuilder::setCallerNonce()</a> was not set when creating keys for encryption/decryption).

**Returns**

[telux::common::ErrorCode](#) as appropriate.

**Note**

Eval: This is a new API and is being evaluated. It is subject to change and could break backwards compatibility.

**4.48.1.22.2.8** `virtual telux::common::ErrorCode telux::sec::ICryptoManager::decryptData ( std::shared_ptr< ICryptoParam > cryptoParam, std::vector< uint8_t > const & keyBlob, std::vector< uint8_t > const & encryptedText, std::vector< uint8_t > & decryptedText ) [pure virtual]`

Decrypts data per the given inputs to the decryption algorithm.

On platforms with access control enabled, the caller needs to have TELUX\_SEC\_ENCRYPTION\_OPS permission to successfully invoke this API.

**Parameters**

in	<i>cryptoParam</i>	Input parameters passed to the decryption algorithm.
in	<i>keyBlob</i>	Key blob to be used for decryption.
in	<i>encryptedText</i>	Encrypted data to be decrypted.
out	<i>decryptedText</i>	Decrypted data.

**Returns**

[telux::common::ErrorCode](#) as appropriate.

**Note**

Eval: This is a new API and is being evaluated. It is subject to change and could break backwards compatibility.

**4.48.1.23 class telux::sec::CryptoParamBuilder**

[CryptoParamBuilder](#) helps setup input parameters for a given crypto operation.

**Public member functions**

- [CryptoParamBuilder \(\)](#)
- [CryptoParamBuilder setAlgorithm \(AlgorithmTypes algorithm\)](#)
- [CryptoParamBuilder setCryptoOperation \(CryptoOperationTypes operation\)](#)
- [CryptoParamBuilder setDigest \(DigestTypes digest\)](#)
- [CryptoParamBuilder setPadding \(PaddingTypes padding\)](#)
- [CryptoParamBuilder setKeySize \(int32\\_t keySize\)](#)
- [CryptoParamBuilder setMinimumMacLength \(int32\\_t minMacLength\)](#)
- [CryptoParamBuilder setMacLength \(int32\\_t macLength\)](#)
- [CryptoParamBuilder setBlockMode \(BlockModeTypes blockMode\)](#)
- [CryptoParamBuilder setCurve \(int32\\_t curve\)](#)
- [CryptoParamBuilder setCallerNonce \(bool callerNonce\)](#)
- [CryptoParamBuilder setPublicExponent \(uint64\\_t publicExponent\)](#)
- [CryptoParamBuilder setInitVector \(std::vector< uint8\\_t > initVector\)](#)
- [CryptoParamBuilder setUniqueData \(std::vector< uint8\\_t > uniqueData\)](#)
- [CryptoParamBuilder setAssociatedData \(std::vector< uint8\\_t > associatedData\)](#)
- [std::shared\\_ptr< ICryptoParam > build \(void\)](#)

#### 4.48.1.23.1 Constructors and Destructors

##### 4.48.1.23.1.1 `telux::sec::CryptoParamBuilder::CryptoParamBuilder ( )`

Allocates an instance of [CryptoParamBuilder](#).

#### 4.48.1.23.2 Member Function Documentation

##### 4.48.1.23.2.1 `CryptoParamBuilder telux::sec::CryptoParamBuilder::setAlgorithm ( AlgorithmTypes algorithm )`

When generating keys, specifies with which algorithm the keys will be used. For crypto operations, specifies the algorithm to use. Use [telux::sec::Algorithm](#) enumeration to define this.

##### 4.48.1.23.2.2 `CryptoParamBuilder telux::sec::CryptoParamBuilder::setCryptoOperation ( Crypto← OperationTypes operation )`

When generating keys, specifies the crypto operation(s) for which the key will be used. For crypto operations, specifies the operation itself (encrypting/decrypting/ signing/verifying). Use [telux::sec::CryptoOperation](#) enumeration to define this. Multiple operation values can be OR'ed (`|`).

##### 4.48.1.23.2.3 `CryptoParamBuilder telux::sec::CryptoParamBuilder::setDigest ( DigestTypes digest )`

When generating keys, specifies the digest algorithm(s) that may be used with the key to perform signing and verifying operations using RSA, ECDSA, and HMAC keys. For crypto operations, specifies exact digest algorithm to be used. Use [telux::sec::Digest](#) enumeration to define this. Multiple values can be OR'ed (`|`).

##### 4.48.1.23.2.4 `CryptoParamBuilder telux::sec::CryptoParamBuilder::setPadding ( PaddingTypes padding )`

When generating keys, specifies the padding modes that may be used with the RSA and AES key. For crypto operations, specifies the exact padding to be used. Use [telux::sec::Padding](#) enumeration to define this. Multiple padding values can be OR'ed (`|`).

##### 4.48.1.23.2.5 `CryptoParamBuilder telux::sec::CryptoParamBuilder::setKeySize ( int32_t keySize )`

When generating keys, specifies the size in bits, of the key, measured in the regular way for the key's algorithm.

- For RSA keys, specifies the size of the public modulus.
- For AES keys, specifies length of the secret key material.
- For HMAC keys, specifies the key size in bits.
- For EC keys, selects the EC group.

#### 4.48.1.23.2.6 **CryptoParamBuilder telux::sec::CryptoParamBuilder::setMinimumMacLength ( int32\_t minMacLength )**

When generating keys, specifies minimum length of the MAC in bits that can be requested or verified with this key for HMAC keys and AES keys that support GCM mode.

#### 4.48.1.23.2.7 **CryptoParamBuilder telux::sec::CryptoParamBuilder::setMacLength ( int32\_t macLength )**

For crypto operations, specifies requested length of a MAC or GCM (which is guaranteed to be no less than minimum length of the MAC/GCM used when generating the key).

#### 4.48.1.23.2.8 **CryptoParamBuilder telux::sec::CryptoParamBuilder::setBlockMode ( BlockModeTypes blockMode )**

When generating keys, specifies the block cipher mode(s) with which this key can be used. For crypto operations, specifies the exact block mode to be used. Use [telux::sec::BlockMode](#) enumeration to define this. Multiple block mode values can be OR'ed (|).

#### 4.48.1.23.2.9 **CryptoParamBuilder telux::sec::CryptoParamBuilder::setCurve ( int32\_t curve )**

When generating the keys using an EC algorithm, only key size, only curve, or both key size and curve can be specified. If only key size is specified, the appropriate NIST curve is selected automatically. If only curve is specified, the given curve is used. If both are specified, the given curve is used and key size is validated.

#### 4.48.1.23.2.10 **CryptoParamBuilder telux::sec::CryptoParamBuilder::setCallerNonce ( bool callerNonce )**

When generating AES key, if callerNonce is set to true, it specifies that an explicit nonce will be supplied by the caller during encryption and decryption using [setInitVector\(\)](#). If the callerNonce is set to false (or not set), platform will generate the nonce during encryption. This nonce should be passed during decryption.

#### 4.48.1.23.2.11 **CryptoParamBuilder telux::sec::CryptoParamBuilder::setPublicExponent ( uint64\_t publicExponent )**

When generating an RSA key, specifies the value of the public exponent for an RSA key pair (necessary for all RSA keys).

#### 4.48.1.23.2.12 **CryptoParamBuilder telux::sec::CryptoParamBuilder::setInitVector ( std::vector< uint8\_t > initVector )**

When performing AES crypto operations, specifies the initialization vector to be used.

#### 4.48.1.23.2.13 **CryptoParamBuilder** `telux::sec::CryptoParamBuilder::setUniqueData ( std::vector< uint8_t > uniqueData )`

When generating or importing a key, an optional arbitrary value can be supplied through this method. In all subsequent use of the key, this value must be supplied again. The data given is bound to the key cryptographically. This data ties the key to the caller.

#### 4.48.1.23.2.14 **CryptoParamBuilder** `telux::sec::CryptoParamBuilder::setAssociatedData ( std::vector< uint8_t > associatedData )`

When encrypting/decrypting data, this specifies optional associated data to be used. This is applicable only for AES-GCM algorithm.

#### 4.48.1.23.2.15 `std::shared_ptr<ICryptoParam>` **telux::sec::CryptoParamBuilder::build ( void )**

Creates an instance of [ICryptoParam](#) based on the setter methods invoked on the builder. After building the builder's state is reset.

### 4.48.1.24 **class telux::sec::SecurityFactory**

[SecurityFactory](#) allows creation of [ICryptoManager](#) and [ICryptoAcceleratorManager](#).

#### Public member functions

- virtual `std::shared_ptr< ICryptoManager > getCryptoManager (telux::common::ErrorCode &ec)=0`
- virtual `std::shared_ptr< ICryptoAcceleratorManager > getCryptoAcceleratorManager (telux::common::ErrorCode &ec, Mode mode, std::weak_ptr< ICryptoAcceleratorListener > cryptoAccelListener=std::weak_ptr< ICryptoAcceleratorListener >())=0`
- virtual `std::shared_ptr< ICAControlManager > getCAControlManager (telux::common::ErrorCode &ec)=0`

#### Static Public Member Functions

- static `SecurityFactory & getInstance ()`

### 4.48.1.24.1 Member Function Documentation

#### 4.48.1.24.1.1 `static SecurityFactory& telux::sec::SecurityFactory::getInstance ( ) [static]`

Gets the [SecurityFactory](#) instance.

#### 4.48.1.24.1.2 `virtual std::shared_ptr<ICryptoManager> telux::sec::SecurityFactory::getCryptoManager ( telux::common::ErrorCode & ec ) [pure virtual]`

Instantiates a [CryptoManager](#) instance that can be used to perform key management and cryptographic operations.

**Parameters**

out	<i>ec</i>	<a href="#">telux::common::ErrorCode::SUCCESS</a> if <a href="#">ICryptoManager</a> is created successfully, otherwise, an appropriate error code
-----	-----------	---

**Returns**

[ICryptoManager](#) instance

**Note**

Eval: This is a new API and is being evaluated. It is subject to change and could break backwards compatibility.

```
4.48.1.24.1.3 virtual std::shared_ptr<ICryptoAcceleratorManager> telux::sec::Security↔
Factory::getCryptoAcceleratorManager ( telux::common::ErrorCode & ec, Mode
mode, std::weak_ptr< ICryptoAcceleratorListener > cryptoAccelListener =
std::weak_ptr< ICryptoAcceleratorListener > () ) [pure virtual]
```

Provides a [CryptoAcceleratorManager](#) instance that can be used to perform cryptographic operations requiring elliptic-curve cryptography (ECC) verifications and calculations.

Providing [ICryptoAcceleratorListener](#) instance is mandatory when using [Mode::MODE\\_ASYNC\\_LISTENER](#). It is not required with modes, [Mode::MODE\\_SYNC](#) and [Mode::MODE\\_ASYNC\\_POLL](#) for cryptographic operations.

To receive subsystem-restart (SSR) updates, application must provide [ICryptoAcceleratorListener](#) instance (irrespective of [Mode::\\*](#)) and implement method [telux::common::IServiceStatusListener::onServiceStatusChange\(\)](#).

Specifying mode ([Mode::\\*](#)) defines how an application will send request and receive cryptographic results.

Passing listener determines whether an application is also interested in SSR updates in addition to cryptographic results or not.

On platforms with access control enabled, caller needs to have `TELUX_SEC_ACCELERATOR_MGR` permission to invoke this API successfully.

**Parameters**

out	<i>ec</i>	<a href="#">telux::common::ErrorCode::SUCCESS</a> if <a href="#">ICryptoAcceleratorManager</a> is created successfully, otherwise, an appropriate error code
in	<i>mode</i>	Defines how users obtain verification and calculation results
in	<i>cryptoAccelListener</i>	Optional, listener for ECC signature verification and ECQV calculation results

**Returns**

[ICryptoAcceleratorManager](#) instance

#### 4.48.1.24.1.4 virtual std::shared\_ptr<ICAControlManager> telux::sec::SecurityFactory::getCAControlManager ( telux::common::ErrorCode & ec ) [pure virtual]

Provides an [ICAControlManager](#) instance that can be used to collect statistical information about usage of the crypto accelerator.

On platforms with access control enabled, caller needs to have TELUX\_SEC\_CA\_CONTROL\_MGR permission to invoke this API successfully.

##### Parameters

out	ec	<a href="#">telux::common::ErrorCode::SUCCESS</a> if the <a href="#">ICAControlManager</a> is created successfully, otherwise, an appropriate error code
-----	----	--

##### Returns

[ICAControlManager](#) instance

##### Note

Eval: This is a new API and is being evaluated. It is subject to change and could break backwards compatibility.

#### 4.48.1.25 struct telux::sec::MLAlgorithmAnalysis

Machine learning algorithm threat analysis result per AP.

##### Data fields

Type	Field	Description
uint32_t	threatScore	Higher threat scores indicate a higher possibility that the AP is malicious; range is 0 to 100.
<a href="#">AnalysisResult</a>	result	Result of the security analysis for a given AP.

#### 4.48.1.26 struct telux::sec::SummoningAnalysis

Summoning attack threat analysis result.

##### Data fields

Type	Field	Description
<a href="#">AnalysisResult</a>	result	Result of the security analysis for a given AP.

#### 4.48.1.27 struct telux::sec::WiFiSecurityReport

Represents the security report for a Wi-Fi AP.

**Data fields**

Type	Field	Description
string	ssid	Network interface name of the AP.
string	bssid	MAC address of the AP.
bool	isConnected↔ ToAP	True if the device is connected to this AP.
bool	isOpenAP	True if devices can connect to this AP without authentication.
<a href="#">ML↔ Algorithm↔ Analysis</a>	mlAlgorithm↔ Analysis	Machine learning algorithm threat analysis result.
<a href="#">Summoning↔ Analysis</a>	summoning↔ Analysis	Summoning attack threat analysis result.

**4.48.1.28 struct telux::sec::DeauthenticationInfo**

Represents information about a deauthentication attack.

**Data fields**

Type	Field	Description
int	deauthentication↔ Reason	Reason code why disassociation or deauthentication occurred as specified by the IEEE 802.11 standard.
bool	didAPInitiate↔ Disconnect	True if the AP initiated the disconnection.
uint32_t	threatScore	Higher threat scores indicate a higher possibility that this is a deauthentication attack; range is 0 to 100.

**4.48.1.29 struct telux::sec::ApInfo**

Represents a WiFi access point.

**Data fields**

Type	Field	Description
string	ssid	Network interface name of the AP.
string	bssid	MAC address of the AP.

**4.48.1.30 class telux::sec::WiFiReportListener**

Receives security analysis reports for the Wi-Fi APs detected while scanning for APs in the vicinity and provides a listener for deauthentication attacks.

**Public member functions**

- virtual void [onReportAvailable](#) ([WiFiSecurityReport](#) report)
- virtual void [onDeauthenticationAttack](#) ([DeauthenticationInfo](#) deauthenticationInfo)



- virtual void `isTrustedAP (ApInfo accessPoint, bool &isTrusted)`
- virtual `~IWiFiReportListener ()`

#### 4.48.1.30.1 Constructors and Destructors

4.48.1.30.1.1 virtual `telux::sec::IWiFiReportListener::~~IWiFiReportListener ( ) [virtual]`

[IWiFiReportListener](#) destructor.

#### 4.48.1.30.2 Member Function Documentation

4.48.1.30.2.1 virtual void `telux::sec::IWiFiReportListener::onReportAvailable ( WiFiSecurityReport report ) [virtual]`

Notifies that the implementation completed a threat analysis and that the report is available This analysis is performed at various triggers, for example, when a scan for APs is triggered the implementation will perform an analysis and provide a report for every AP it sees in the vicinity.

##### Parameters

in	<i>report</i>	<a href="#">WiFiSecurityReport</a> result of the Wi-Fi security analysis.
----	---------------	---

##### Note

Eval: This is a new API and is being evaluated. It is subject to change and could break backwards compatibility.

4.48.1.30.2.2 virtual void `telux::sec::IWiFiReportListener::onDeauthenticationAttack ( DeauthenticationInfo deauthenticationInfo ) [virtual]`

Notifies that a deauthentication attack is identified.

##### Parameters

in	<i>deauthenticationInfo</i>	<a href="#">DeauthenticationInfo</a> security analysis information.
----	-----------------------------	---

##### Note

Eval: This is a new API and is being evaluated. It is subject to change and could break backwards compatibility.

#### 4.48.1.30.2.3 virtual void telux::sec::WiFiReportListener::isTrustedAP ( ApInfo *accessPoint*, bool & *isTrusted* ) [virtual]

Gets user confirmation that the given AP is trusted. This is called only once when the device connects to this AP for the very first time. If the application trusts the given AP, it should set 'isTrusted' to True. Otherwise it should be set to false.

Once the users confirms that an AP is trusted, this information is saved internally and used later to detect threats like evil twin attacks.

On platforms with access control enabled, the caller needs to have the TELUX\_SEC\_WCS\_CONFIG permission to successfully invoke this API.

#### Parameters

in	<i>accessPoint</i>	<a href="#">ApInfo</a> provides information about an AP.
out	<i>isTrusted</i>	True if trusted; false otherwise.

#### Note

Eval: This is a new API and is being evaluated. It is subject to change and could break backwards compatibility.

### 4.48.1.31 class telux::sec::WiFiSecurityManager

Provides support for detecting, monitoring, and generating security reports for Wi-Fi APs.

#### Public member functions

- virtual [telux::common::ErrorCode](#) registerListener (std::weak\_ptr< [WiFiReportListener](#) > reportListener)=0
- virtual [telux::common::ErrorCode](#) deregisterListener (std::weak\_ptr< [WiFiReportListener](#) > reportListener)=0
- virtual [telux::common::ErrorCode](#) getTrustedApList (std::vector< [ApInfo](#) > &trustedApList)=0
- virtual [telux::common::ErrorCode](#) removeApFromTrustedList ([ApInfo](#) apInfo)=0
- virtual [~WiFiSecurityManager](#) ()

#### 4.48.1.31.1 Constructors and Destructors

##### 4.48.1.31.1.1 virtual telux::sec::WiFiSecurityManager::~WiFiSecurityManager ( ) [virtual]

[WiFiSecurityManager](#) destructor; cleans up as applicable.

#### 4.48.1.31.2 Member Function Documentation

#### 4.48.1.31.2.1 virtual telux::common::ErrorCode telux::sec::WiFiSecurityManager::registerListener ( std::weak\_ptr< IWiFiReportListener > *reportListener* ) [pure virtual]

Registers the given listener to receive Wi-Fi connection security reports. These reports will be received by [IWiFiReportListener::onReportAvailable\(\)](#).

On platforms with access control enabled, the caller needs to have the TELUX\_SEC\_WCS\_REPORT permission to successfully invoke this API.

##### Parameters

in	<i>reportListener</i>	Receives security reports.
----	-----------------------	----------------------------

##### Returns

[telux::common::ErrorCode::SUCCESS](#), if the listener is registered, otherwise, an appropriate error code.

##### Note

Eval: This is a new API and is being evaluated. It is subject to change and could break backwards compatibility.

#### 4.48.1.31.2.2 virtual telux::common::ErrorCode telux::sec::WiFiSecurityManager::deregisterListener ( std::weak\_ptr< IWiFiReportListener > *reportListener* ) [pure virtual]

Unregisters the given listener registered previously with [registerListener\(\)](#).

On platforms with access control enabled, the caller needs to have the TELUX\_SEC\_WCS\_REPORT permission to successfully invoke this API.

##### Parameters

in	<i>reportListener</i>	Listener to unregister.
----	-----------------------	-------------------------

##### Returns

[telux::common::ErrorCode::SUCCESS](#), if the listener is deregistered, otherwise, an appropriate error code.

##### Note

Eval: This is a new API and is being evaluated. It is subject to change and could break backwards compatibility.

#### 4.48.1.31.2.3 `virtual telux::common::ErrorCode telux::sec::WiFiSecurityManager::getTrustedApList ( std::vector< ApInfo > & trustedAPList ) [pure virtual]`

Lists all the trusted APs.

On platforms with access control enabled, the caller needs to have the TELUX\_SEC\_WCS\_INFO permission to successfully invoke this API.

##### Parameters

out	<i>trustedAPList</i>	List of trusted APs ( <a href="#">ApInfo</a> ).
-----	----------------------	---

##### Returns

[telux::common::ErrorCode::SUCCESS](#), if the list is retrived otherwise, an appropriate error code.

##### Note

Eval: This is a new API and is being evaluated. It is subject to change and could break backwards compatibility.

#### 4.48.1.31.2.4 `virtual telux::common::ErrorCode telux::sec::WiFiSecurityManager::removeApFromTrustedList ( ApInfo apInfo ) [pure virtual]`

Removes the given AP from the saved list of trusted APs. If the device connects to the same AP again, [WiFiReportListener::isTrustedAP\(\)](#) will be invoked again.

On platforms with access control enabled, the caller needs to have the TELUX\_SEC\_WCS\_CONFIG permission to successfully invoke this API.

##### Parameters

in	<i>apInfo</i>	AP to distrust ( <a href="#">ApInfo</a> ).
----	---------------	--

##### Returns

[telux::common::ErrorCode::SUCCESS](#), if the AP is distrusted otherwise, an appropriate error code.

##### Note

Eval: This is a new API and is being evaluated. It is subject to change and could break backwards compatibility.

## 4.48.2 Enumeration Type Documentation

### 4.48.2.1 `enum telux::sec::CellularThreatType [strong]`

Describes the cellular threats detected.

**Enumerator**

- UNKNOWN** No scoring (analysis) has been performed yet or it is in-progress. For example; during cell reselection, a device may be camped to a new cell and may remain idle (not exchanging data over cellular network). During this time scoring is not done. When device uses cellular network for actual use, scoring is done.
- IMPRISON** Base station (BS) configuration is preventing the device from connecting to the neighboring base stations.
- DOS** BS intercepts or jams signals to and from the device such that it results in a denial of cellular service.
- DOWNGRADE** BS is forcing the device to downgrade to use less secure cellular service. For example; downgrade from LTE to second-generation cellular network (2G).
- LOCATION\_TRACKED\_USING\_IMSI** BS is continuously tracking location of the device.
- LOCATION\_TRACKED\_USING\_AUTH** BS is continuously tracking location of the device using the authentication process.
- PERSUADE** BS portrays itself as the best option for the UE to select.
- NO\_THREAT\_DETECTED** No threat has been detected for this base station.
- NO\_ENCRYPTION** GSM EDGE radio access network (GERAN) BS is not using encryption.
- WEAK\_ENCRYPTION** GERAN BS is using weak encryption.
- SELF\_BLACKLISTING\_CELL** When using long-term evolution (LTE), BS blacklisted itself on physical layer cell identity (PCI) and E-UTRA absolute radio frequency channel number (EARFCN).
- UNAUTHENTICATED\_SMS** On an unauthenticated GERAN, a short message service (SMS) was received.
- UNAUTHENTICATED\_EMERGENCY\_MESSAGE** On an unauthenticated GERAN, an emergency message was received.
- IMSI\_LEAK** The international mobile subscriber identity (IMSI) of the device has leaked in an unencrypted state to an unauthenticated base station.

**4.48.2.2 enum telux::sec::EnvironmentState [strong]**

Describes the state of the cellular environment observed by the device.

**Enumerator**

- UNKNOWN** No scoring (analysis) has been performed yet or it is in-progress.
- SAFE** Device and base station have authenticated each other and connected.
- ALERT** Environment is potentially unsafe to operate. There may be potentially malicious BS. The threat score has crossed configured threshold at least once. More analysis needed to conclude, if the environment is safe.
- HOSTILE** Environment is hostile and threats have been detected. For example, compromised/malicious base stations are detected in the environment.

**4.48.2.3 enum telux::sec::ActionType [strong]**

Based on the policy configured on the device, certain actions are taken automatically. For example; when a compromised/malicious BS is detected, it is blacklisted (cell barring) for a certain period of time (hence device will not be able to connect to it).

When configured action has been taken, a security report is generated. In that report, ActionType represents exact action taken.

**Enumerator**

**NONE** No specific action taken.

**DEPRIORITIZED** Priority of this cell for selection is reduced so that other cells get more priority for cell selection/reselection during device attempting to camp to a cell.

**REMOVED\_DEPRIORITIZATION** Priority of this cell (previously deprioritized) for selection is resumed to regular status.

**CELL\_BARRED** This cell has been barred (device will not camp to this cell).

**REMOVED\_CELL\_BARRING** Cell barring has been removed from this previously barred cell. This cell can be considered for connection, during cell selection/reselection process.

**INVALID** The configured action was outside the allowed range of actions.

**4.48.2.4 enum telux::sec::RATType [strong]**

Defines all the cell info types.

**Enumerator**

**UNKNOWN**

**GSM**

**WCDMA**

**LTE**

**NR5G**

**4.48.2.5 enum telux::sec::Mode [strong]**

Defines how the user gets verification and calculation results.

**Enumerator**

**MODE\_SYNC** [ICryptoAcceleratorManager::eccVerifyDigest\(\)](#) and [ICryptoAcceleratorManager::ecqvPointMultiplyAndAdd\(\)](#) APIs are used to send verification and calculation data and obtain results synchronously.

**MODE\_ASYNC\_POLL** [ICryptoAcceleratorManager::eccPostDigestForVerification\(\)](#) and [ICryptoAcceleratorManager::ecqvPostDataForMultiplyAndAdd\(\)](#) APIs are used to send verification and calculation data. Results are obtained via [ICryptoAcceleratorManager::getAsyncResults\(\)](#) API.

**MODE\_ASYNC\_LISTENER** [ICryptoAcceleratorManager::eccPostDigestForVerification\(\)](#) and [ICryptoAcceleratorManager::ecqvPostDataForMultiplyAndAdd\(\)](#) APIs are used to send verification and calculation data. Results are obtained asynchronously in [ICryptoAcceleratorListener::onVerificationResult\(\)](#) and [ICryptoAcceleratorListener::onCalculationResult\(\)](#) callbacks.

**4.48.2.6 enum telux::sec::RequestPriority [strong]**

Relative priority of the request.

**Enumerator**

**REQ\_PRIORITY\_HIGH** High priority

**REQ\_PRIORITY\_NORMAL** Lower priority (compared to high priority data)

#### 4.48.2.7 enum telux::sec::ECCCurve [strong]

Elliptic curve used by ECC algorithm.

##### Enumerator

*CURVE\_SM2*  
*CURVE\_NISTP256*  
*CURVE\_NISTP384*  
*CURVE\_BRAINPOOLP256R1*  
*CURVE\_BRAINPOOLP384R1*

#### 4.48.2.8 enum telux::sec::OperationType [strong]

Type of operation carried by crypto accelerator.

##### Enumerator

*OP\_TYPE\_VERIFY*  
*OP\_TYPE\_CALCULATE*

#### 4.48.2.9 enum telux::sec::CryptoOperation

Specifies the operation for which the key can be used. A key can be used for multiple operation types.

##### Enumerator

*CRYPTO\_OP\_ENCRYPT* Key will be used for encryption.  
*CRYPTO\_OP\_DECRYPT* Key will be used for decryption.  
*CRYPTO\_OP\_SIGN* Key will be used for signing.  
*CRYPTO\_OP\_VERIFY* Key will be used for verification.

#### 4.48.2.10 enum telux::sec::BlockMode

Specifies the block cipher mode(s) with which the AES key may be used.

##### Enumerator

*BLOCK\_MODE\_ECB* Electronic code block mode  
*BLOCK\_MODE\_CBC* Cipher block chain mode  
*BLOCK\_MODE\_CTR* Counter-based mode  
*BLOCK\_MODE\_GCM* Galois/counter mode

#### 4.48.2.11 enum telux::sec::Padding

Padding modes that may be applied to plain text for encryption operations. Only cryptographically-appropriate pairs are specified here.

##### Enumerator

*PADDING\_NONE* No padding.  
*PADDING\_RSA\_OAEP* RSA optimal asymmetric encryption padding.

**PADDING\_RSA\_PSS** RSA probabilistic signature scheme.  
**PADDING\_RSA\_PKCS1\_1\_5\_ENC** RSA PKCS#1 v1.5 padding for encryption.  
**PADDING\_RSA\_PKCS1\_1\_5\_SIGN** RSA PKCS#1 v1.5 padding for signing.  
**PADDING\_PKCS7** Public-key cryptography standard.

#### 4.48.2.12 enum telux::sec::Digest

Specifies the digest algorithms that may be used with the key to perform signing and verification operations using RSA, ECDSA, and HMAC keys. The digest used during signing or verification must match the digest associated with the key when the key was generated.

##### Enumerator

**DIGEST\_NONE** No digest.  
**DIGEST\_MD5** Message-digest algorithm.  
**DIGEST\_SHA1** Secure hash algorithm 1  
**DIGEST\_SHA\_2\_224** Secure hash algorithm 2, digest 224.  
**DIGEST\_SHA\_2\_256** Secure hash algorithm 2, digest 256.  
**DIGEST\_SHA\_2\_384** Secure hash algorithm 2, digest 384.  
**DIGEST\_SHA\_2\_512** Secure hash algorithm 2, digest 512.

#### 4.48.2.13 enum telux::sec::Algorithm

Algorithm for signing, verification, encryption, and decryption operations.

##### Enumerator

**ALGORITHM\_UNKNOWN** Unspecified algorithm.  
**ALGORITHM\_RSA** RSA (Rivest–Shamir–Adleman) algorithm.  
**ALGORITHM\_EC** Elliptic-curve algorithm.  
**ALGORITHM\_AES** Advanced encryption standard algorithm.  
**ALGORITHM\_HMAC** Hash-based message authentication code algorithm.

#### 4.48.2.14 enum telux::sec::Curve

NIST curves used with ECDSA.

##### Enumerator

**CURVE\_P\_224** NIST curve P-224.  
**CURVE\_P\_256** NIST curve P-256.  
**CURVE\_P\_384** NIST curve P-384.  
**CURVE\_P\_521** NIST curve P-521.

#### 4.48.2.15 enum telux::sec::KeyFormat

Formats for key import and export.



**Enumerator**

**KEY\_FORMAT\_X509** Public key export.  
**KEY\_FORMAT\_PKCS8** Asymmetric key pair import.  
**KEY\_FORMAT\_RAW** Symmetric key import and export.

**4.48.2.16 enum telux::sec::AnalysisResult [strong]**

Security analysis result for a given access point (AP).

**Enumerator**

**NO\_RESULT** There was no result for this AP because either the device is moving or the AP is on the fringes of signal strength.  
**NEW\_ASSOCIATION** This is the first time this AP is used for a connection and no previous references exist.  
**NO\_THREAT\_DETECTED** The AP appears safe.  
**MALICIOUS** The AP is not safe.

**4.48.3 Variable Documentation****4.48.3.1 const uint32\_t telux::sec::CA\_RESULT\_DATA\_LENGTH = 96 [static]**

Length of the unparsed raw result from the crypto accelerator.

## 4.49 Wlan

- [WLAN Device Management](#)
- [Access Point Management](#)
- [Station Management](#)

This section contains APIs related to WLAN management operations.

## 4.50 WLAN Device Management

This section contains APIs related to device configuration management, such as the number of access points and stations enabled, WLAN enable/disable, etc

### 4.50.1 Data Structure Documentation

#### 4.50.1.1 struct telux::wlan::ApInfo

AP Info - captures ap type (private/guest)

##### Data fields

Type	Field	Description
<a href="#">BandType</a>	apRadio	Radio type (2.4/5.0 GHz)
<a href="#">ApType</a>	apType	Ap type (private/guest)

#### 4.50.1.2 struct telux::wlan::ApNetInfo

Ap Network Info

##### Data fields

Type	Field	Description
<a href="#">ApInfo</a>	info	Ap information (AP type)
string	ssid	SSID associated with this network

#### 4.50.1.3 struct telux::wlan::ApStatus

AP Status for enabled Networks

##### Data fields

Type	Field	Description
<a href="#">Id</a>	id	AP id
string	name	AP network interface name
string	ipv4Address	Local AP IP V4 address
string	macAddress	AP MAC address
vector< <a href="#">Ap↔ NetInfo</a> >	network	Settings for AP info

#### 4.50.1.4 struct telux::wlan::StaStatus

Station Status

##### Data fields

Type	Field	Description
<a href="#">Id</a>	id	Station Id

Type	Field	Description
string	name	Network interface name
string	ipv4Address	Public IP V4 address
string	ipv6Address	Public IP V6 address
string	macAddress	MAC address
<a href="#">StaInterface↔ Status</a>	status	Interface status

#### 4.50.1.5 struct telux::wlan::InterfaceStatus

Wlan Interface status

##### Data fields

Type	Field	Description
<a href="#">HwDeviceType</a>	device	
vector< <a href="#">Ap↔ Status</a> >	apStatus	WiFi hardware type Vector of active APs status
vector< <a href="#">Sta↔ Status</a> >	staStatus	Vector of active Sta status

#### 4.50.1.6 struct telux::wlan::RegulatoryParams

Wlan Regulatory Setting

##### Data fields

Type	Field	Description
string	country	Country code according to ISO 3166 standard
float	opChannel	Operating channel according to IEEE 802.11 Standards
vector< float >	opClass	Operating class according to IEEE 802.11 Standards
uint32_t	txPowerMw	Transmit power in multiple of 100 MilliWatts Actual transmit power = value set here * 100 milliwatts

#### 4.50.1.7 class telux::wlan::IWlanDeviceManager

WlanDeviceManager is a primary interface for configuring Wireless LAN. it provide APIs to enable, configure, activate, and modify modes.

##### Public member functions

- virtual [telux::common::ServiceStatus](#) getServiceStatus ()=0
- virtual [telux::common::ErrorCode](#) enable (bool enable)=0
- virtual [telux::common::ErrorCode](#) setMode (int numOfAp, int numOfSta)=0
- virtual [telux::common::ErrorCode](#) getConfig (int &numAp, int &numSta)=0

- virtual `telux::common::ErrorCode` `getStatus` (`bool &isEnabled`, `std::vector< InterfaceStatus >` `&status`)=0
- virtual `telux::common::ErrorCode` `setActiveCountry` (`std::string` `country`)=0
- virtual `telux::common::ErrorCode` `getRegulatoryParams` (`RegulatoryParams` `&regulatoryParams`)=0
- virtual `telux::common::ErrorCode` `setTxPower` (`uint32_t` `txPowerMw`)=0
- virtual `telux::common::ErrorCode` `getTxPower` (`uint32_t` `&txPowerMw`)=0
- virtual `telux::common::ErrorCode` `registerListener` (`std::weak_ptr< IWlanListener >` `listener`)=0
- virtual `telux::common::ErrorCode` `deregisterListener` (`std::weak_ptr< IWlanListener >` `listener`)=0
- virtual `~IWlanDeviceManager` ()

#### 4.50.1.8 class `telux::wlan::IWlanListener`

##### Public member functions

- virtual void `onServiceStatusChange` (`telux::common::ServiceStatus` `status`)
- virtual void `onTempCrossed` (`float` `temperature`, `DevicePerfState` `perfState`)
- virtual void `onEnableChanged` (`bool` `enable`)
- virtual `~IWlanListener` ()

#### 4.50.1.9 class `telux::wlan::WlanFactory`

`WlanFactory` is the central factory to create all wlan classes.

##### Public member functions

- virtual `std::shared_ptr< IWlanDeviceManager >` `getWlanDeviceManager` (`telux::common::InitResponseCb` `clientCallback=nullptr`)=0
- virtual `std::shared_ptr< IApInterfaceManager >` `getApInterfaceManager` ()=0
- virtual `std::shared_ptr< IStaInterfaceManager >` `getStaInterfaceManager` ()=0

##### Static Public Member Functions

- static `WlanFactory` `&getInstance` ()

##### Protected Member Functions

- `WlanFactory` ()
- virtual `~WlanFactory` ()

#### 4.50.1.9.1 Constructors and Destructors

**4.50.1.9.1.1** `telux::wlan::WlanFactory::WlanFactory ( ) [protected]`

**4.50.1.9.1.2** `virtual telux::wlan::WlanFactory::~~WlanFactory ( ) [protected], [virtual]`

### 4.50.1.9.2 Member Function Documentation

**4.50.1.9.2.1** `static WlanFactory& telux::wlan::WlanFactory::getInstance ( ) [static]`

Get Wlan Factory instance.

**4.50.1.9.2.2** `virtual std::shared_ptr<IWlanDeviceManager> telux::wlan::WlanFactory::getWlanDeviceManager ( telux::common::InitResponseCb clientCallback = nullptr ) [pure virtual]`

Get Wlan Device Manager

#### Parameters

in	<i>clientCallback</i>	Optional callback to get the initialization status of WlanDeviceManager <a href="#">telux::common::InitResponseCb</a>
----	-----------------------	---

#### Returns

instance of [IWlanDeviceManager](#)

#### Note

Eval: This is a new API and is being evaluated. It is subject to change and could break backwards compatibility.

**4.50.1.9.2.3** `virtual std::shared_ptr<IApInterfaceManager> telux::wlan::WlanFactory::getApInterfaceManager ( ) [pure virtual]`

Get Access Point Interface Manager

#### Returns

instance of [IApInterfaceManager](#)

#### Note

Eval: This is a new API and is being evaluated. It is subject to change and could break backwards compatibility.

**4.50.1.9.2.4** virtual std::shared\_ptr<IStaInterfaceManager> telux::wlan::WlanFactory::getStaInterfaceManager( ) [pure virtual]

Get Station Interface Manager

#### Returns

instance of [IStaInterfaceManager](#)

#### Note

Eval: This is a new API and is being evaluated. It is subject to change and could break backwards compatibility.

## 4.50.2 Enumeration Type Documentation

### 4.50.2.1 enum telux::wlan::BandType [strong]

Radio Band Types:

#### Enumerator

**BAND\_5GHZ**

**BAND\_2GHZ**

### 4.50.2.2 enum telux::wlan::ConnectionStatus [strong]

Connection Status

#### Enumerator

**UNKNOWN** Device connection is unknown

**CONNECTED** Device is connected

**DISCONNECTED** Device is disconnected

### 4.50.2.3 enum telux::wlan::Id [strong]

Identifiers for Ap, Sta, P2p

#### Enumerator

**PRIMARY**

**SECONDARY**

**TERTIARY**

**QUATERNARY**

### 4.50.2.4 enum telux::wlan::ApType [strong]

AP Types:

**Enumerator**

**UNKNOWN**  
**PRIVATE**  
**GUEST**

**4.50.2.5 enum telux::wlan::StaInterfaceStatus [strong]**

Station Interface Status

**Enumerator**

**UNKNOWN** Station interface is unknown  
**CONNECTING** Station interface is connecting  
**CONNECTED** Station interface is connected  
**DISCONNECTED** Station interface is disconnected  
**ASSOCIATION\_FAILED** Station is unable to associate with AP  
**IP\_ASSIGNMENT\_FAILED** Station is unable to get IP address via DHCP

**4.50.2.6 enum telux::wlan::OperationType [strong]**

This applies in architectures where the modem is attached to an External Application Processor(EAP). An API that sets or configure Wlan can be invoked from the EAP or from the modems Internal Application Processor (IAP). This type specifies where the operation should be carried out.

**Enumerator**

**WLAN\_LOCAL** Perform the operation on the processor where the API is invoked.  
**WLAN\_REMOTE** Perform the operation on the application processor other than where the API is invoked.

**4.50.2.7 enum telux::wlan::IpFamilyType [strong]**

Preferred IP family for the connection

**Enumerator**

**UNKNOWN**  
**IPV4** IPv4 data connection  
**IPV6** IPv6 data connection  
**IPV4V6** IPv4 and IPv6 data connection

**4.50.2.8 enum telux::wlan::ServiceOperation [strong]**

Service operations to be performed

**Enumerator**

**STOP** Stop service  
**START** Start service  
**RESTART** Restart service



#### 4.50.2.9 enum telux::wlan::InterfaceState [strong]

Wlan Interface State

##### Enumerator

**INACTIVE** Interface is Inactive

**ACTIVE** Interface is Active

#### 4.50.2.10 enum telux::wlan::HwDeviceType [strong]

Wlan Interface Device

##### Enumerator

**UNKNOWN** Wlan device is Unknown

**QCA6574** Wlan device is QCA6574

**QCA6696** Wlan device is QCA6696

**QCA6595** Wlan device is QCA6595

#### 4.50.2.11 enum telux::wlan::DevicePerfState [strong]

Wlan Device Performance State

##### Enumerator

**UNKNOWN** Device is in Unknown performance state

**FULL** Device is in full performance state

**REDUCED** Device is in reduced performance state

**SHUTDOWN** Device is shutdown

### 4.50.3 Function Documentation

#### 4.50.3.1 virtual telux::common::ServiceStatus telux::wlan::IWlanDeviceManager↔ ::getServiceStatus( ) [pure virtual]

Checks the readiness status of wlan manager and returns the result.

##### Returns

**SERVICE\_AVAILABLE** - If wlan manager is ready for service. **SERVICE\_UNAVAILABLE** - If wlan manager is temporarily unavailable. **SERVICE\_FAILED** - If wlan manager encountered an irrecoverable failure.

##### Note

Eval: This is a new API and is being evaluated. It is subject to change and could break backwards compatibility.

### 4.50.3.2 virtual telux::common::ErrorCode telux::wlan::IWlanDeviceManager::enable ( bool *enable* ) [pure virtual]

Enable or Disable Wlan Service. Configurations set by [telux::wlan::IWlanDeviceManager::setMode](#) must be completed before enabling Wlan. If any of configurations need to be changed after Wlan is enabled, this API must be called with enable set to false followed by a call with enable set to true for the new configurations to take effect. Calling this API with enable, will start hostapd and wpa\_supplicant daemons. Further changes to hostapd and wpa\_supplicant will require calling [telux::wlan::IApInterfaceManager::manageApService](#) and [telux::wlan::IStaInterfaceManager::manageStaService](#) respectively. Client shall wait for [IWlanListener::onEnableChanged](#) indication to confirm WLAN was enabled/disabled successfully

On platforms with Access control enabled, Caller needs to have TELUX\_WLAN\_DEVICE\_CONFIG permission to invoke this API successfully.

#### Parameters

in	<i>enable</i>	true : Enable Wlan, false: Disable Wlan.
----	---------------	--

#### Returns

operation error code (if any). [telux::common::ErrorCode](#)

#### Note

Eval: This is a new API and is being evaluated. It is subject to change and could break backwards compatibility.

### 4.50.3.3 virtual telux::common::ErrorCode telux::wlan::IWlanDeviceManager::setMode ( int *numOfAp*, int *numOfSta* ) [pure virtual]

Set Wlan mode - number of supported APs, and stations. This API shall be called when wlan is disabled. On enablement, wlan will enable APs and Stations set in this API.

#### Parameters

in	<i>numOfAp</i>	Num of Access Points to be enabled. If no Access Point is enabled, this argument should be set to 0. Configuration of each AP is accomplished through <a href="#">telux::data::wlan::IApManager</a> instance requested from factory.
in	<i>numOfSta</i>	Num of Stations to be enabled. If no station is enabled, this argument should be set to 0. Configuration of each Station is accomplished through <a href="#">telux::data::wlan::IStaManager</a> instance requested from factory.

On platforms with Access control enabled, Caller needs to have TELUX\_WLAN\_DEVICE\_CONFIG permission to invoke this API successfully.

#### Returns

operation error code (if any). [telux::common::ErrorCode](#).

**Note**

Eval: This is a new API and is being evaluated. It is subject to change and could break backwards compatibility.

#### 4.50.3.4 **virtual telux::common::ErrorCode telux::wlan::IWlanDeviceManager::get← Config ( int & numAp, int & numSta ) [pure virtual]**

Request Wlan configuration: Returns the configuration that was set using `telux::wlan::IWlanDevice←  
Manager::setMode`. This might differ from what configuration is has actually been enabled in the system, for instance, when the hardware cannot fully support the configuration that was set. To get the status of current configuration an Wlan enablement, [telux::wlan::IWlanDeviceManager::getStatus](#) should be used.

**Parameters**

in	<i>numAp</i>	Num of configured APs
in	<i>numSta</i>	Num of configured Stations

**Returns**

operation error code (if any). [telux::common::ErrorCode](#)

**Note**

Eval: This is a new API and is being evaluated. It is subject to change and could break backwards compatibility.

#### 4.50.3.5 **virtual telux::common::ErrorCode telux::wlan::IWlanDeviceManager::get← Status ( bool & isEnabled, std::vector< InterfaceStatus > & status ) [pure virtual]**

Request Wlan status: Return Wlan enablement status and Interface status of APs and Station such as active/inactive, network interface name and hardware device they are mapped to. Results are valid only if Wlan is enabled.

**Parameters**

in	<i>isEnabled</i>	true: Wlan is enabled. false: Wlan is Disabled.
in	<i>status</i>	vector of interface status <a href="#">InterfaceStatus</a> .

**Returns**

operation error code (if any). [telux::common::ErrorCode](#)

**Note**

Eval: This is a new API and is being evaluated. It is subject to change and could break backwards compatibility.

#### 4.50.3.6 **virtual telux::common::ErrorCode telux::wlan::IWlanDeviceManager::setActiveCountry ( std::string *country* ) [pure virtual]**

Set the country in which the device is operating. The country code will be used to make the device operate using the regulatory parameters pertaining to the active country

On platforms with Access control enabled, Caller needs to have TELUX\_WLAN\_DEVICE\_CONFIG permission to invoke this API successfully.

##### Parameters

in	<i>country</i>	Active country code according to ISO 3166 standard
----	----------------	--

##### Returns

operation error code (if any). [telux::common::ErrorCode](#)

##### Note

Eval: This is a new API and is being evaluated. It is subject to change and could break backwards compatibility.

#### 4.50.3.7 **virtual telux::common::ErrorCode telux::wlan::IWlanDeviceManager::getRegulatoryParams ( RegulatoryParams & *regulatoryParams* ) [pure virtual]**

Request Regulatory Parameters

##### Parameters

out	<i>regulatoryParams</i>	Current Regulatory Settings <a href="#">RegulatoryParams</a> .
-----	-------------------------	--

##### Returns

operation error code (if any). [telux::common::ErrorCode](#)

##### Note

Eval: This is a new API and is being evaluated. It is subject to change and could break backwards compatibility.

#### 4.50.3.8 **virtual telux::common::ErrorCode telux::wlan::IWlanDeviceManager::setTxPower ( uint32\_t *txPowerMw* ) [pure virtual]**

Set Transmit Power Immediately changes WLAN transmit power. The setting will not be persistent across power cycles. To restore default power associated with country set by [telux::wlan::IWlanDeviceManager::setActiveCountry](#), either hostapd or wpa\_supplicant daemons need to be restarted via [telux::wlan::IApInterfaceManager::manageApService](#) or [telux::wlan::IStaInterfaceManager::manageStaService](#)

**Parameters**

in	<i>txPower</i>	Transmit Power to be set in mutiple of 100 milliwatts. For instance, if txPower equals 15, transmit power will be set to 1500 milliwatts.
----	----------------	---

On platforms with Access control enabled, Caller needs to have TELUX\_WLAN\_DEVICE\_CONFIG permission to invoke this API successfully.

**Returns**

operation error code (if any). [telux::common::ErrorCode](#)

**Note**

Eval: This is a new API and is being evaluated.It is subject to change and could break backwards compatibility.

#### 4.50.3.9 **virtual telux::common::ErrorCode telux::wlan::IWlanDeviceManager::getTx↔ Power ( uint32\_t & txPowerMw ) [pure virtual]**

Request Transmit Power

**Parameters**

out	<i>txPowerMw</i>	Current Transmit Power in mutiple of 100 milliwatts.
-----	------------------	--

**Returns**

operation error code (if any). [telux::common::ErrorCode](#)

**Note**

Eval: This is a new API and is being evaluated.It is subject to change and could break backwards compatibility.

#### 4.50.3.10 **virtual telux::common::ErrorCode telux::wlan::IWlanDeviceManager↔ ::registerListener ( std::weak\_ptr< IWlanListener > listener ) [pure virtual]**

Register a listener for specific events in the Wlan Manager

**Parameters**

in	<i>listener</i>	pointer of <a href="#">IWlanListener</a> object that processes the notification
----	-----------------	---

**Returns**

Status of registerListener success or suitable status code

**4.50.3.11** `virtual telux::common::ErrorCode telux::wlan::IWlanDeviceManager↔  
::deregisterListener ( std::weak_ptr< IWlanListener > listener ) [pure  
virtual]`

Removes a previously added listener.

**Parameters**

in	<i>listener</i>	pointer of <a href="#">IWlanListener</a> object that needs to be removed
----	-----------------	--

**Returns**

Status of deregisterListener success or suitable status code

**4.50.3.12** `virtual telux::wlan::IWlanDeviceManager::~~IWlanDeviceManager ( )  
[virtual]`

Destructor for [IWlanDeviceManager](#)

**4.50.3.13** `virtual void telux::wlan::IWlanListener::onServiceStatusChange (   
telux::common::ServiceStatus status ) [virtual]`

This function is called when service status changes.

**Parameters**

in	<i>status</i>	- ServiceStatus
----	---------------	-----------------

**4.50.3.14** `virtual void telux::wlan::IWlanListener::onTempCrossed ( float temperature,  
DevicePerfState perfState ) [virtual]`

This function is called when temperature has crossed threshold

**Parameters**

in	<i>temperature</i>	- current device temperature in Fahrenheit
in	<i>perfState</i>	- current performance state of device due to device temperature

**4.50.3.15** `virtual void telux::wlan::IWlanListener::onEnableChanged ( bool enable )  
[virtual]`

This function is called when Wlan enablement has changed

**Parameters**

in	<i>enable</i>	True: Wlan is enabled, False: Wlan is disabled
----	---------------	--

**4.50.3.16** `virtual telux::wlan::IWlanListener::~~IWlanListener ( ) [virtual]`

## **4.50.4 Variable Documentation**

**4.50.4.1** `HwDeviceType telux::wlan::InterfaceStatus::device`

WiFi hardware type

Vector of active APs status

**4.50.4.2** `std::vector<ApStatus> telux::wlan::InterfaceStatus::apStatus`

Vector of active Sta status

**4.50.4.3** `std::string telux::wlan::RegulatoryParams::country`

Country code according to ISO 3166 standard

**4.50.4.4** `float telux::wlan::RegulatoryParams::opChannel`

Operating channel according to IEEE 802.11 Standards

**4.50.4.5** `std::vector<float> telux::wlan::RegulatoryParams::opClass`

Operating class according to IEEE 802.11 Standards

**4.50.4.6** `uint32_t telux::wlan::RegulatoryParams::txPowerMw`

Transmit power in multiple of 100 MilliWatts Actual transmit power = value set here \* 100 milliwatts

## 4.51 Access Point Management

This section contains APIs related to access point configuration management, such as private/guest, internet/local access, etc.

### 4.51.1 Define Documentation

#### 4.51.1.1 #define INVALID\_AP\_ID 0

### 4.51.2 Data Structure Documentation

#### 4.51.2.1 struct telux::wlan::ApVenueInfo

Wlan AP Venue Info as defined in IEEE Std 802.11u-2011, 7.3.1.34

##### Data fields

Type	Field	Description
int	type	Venue Type
int	group	Venue Group

#### 4.51.2.2 struct telux::wlan::ApSecurity

AP Security

##### Data fields

Type	Field	Description
<a href="#">SecMode</a>	mode	Security mode
<a href="#">SecAuth</a>	auth	Authorization method
<a href="#">SecEncrypt</a>	encrypt	Encryption method

#### 4.51.2.3 struct telux::wlan::ApElementInfoConfig

AP Element Info

##### Data fields

Type	Field	Description
bool	isEnabled	
bool	is↔ Interworking↔ Enabled	Interworking Service enablement
<a href="#">NetAccessType</a>	netAccessType	Network Access Type
bool	internet	Whether network provide connectivity to internet
bool	asra	Additional step required for access
bool	esr	Emergency services reachable
bool	uesa	Unauthenticated emergency service accessible
uint8_t	venueGroup	Venue group



Type	Field	Description
uint8_t	venueType	Venue type
string	hessid	Homogeneous ESS identifier
string	vendor↔ Elements	Vendor elements for Beacon and Probe Response frames
string	assocResp↔ Elements	Vendor elements for (Re)Association Response frames

#### 4.51.2.4 struct telux::wlan::ApNetConfig

Ap Network Configuration

##### Data fields

Type	Field	Description
<a href="#">ApInfo</a>	info	AP type
string	ssid	SSID for AP
bool	isVisible	AP broadcast SSID
<a href="#">ApElement↔ InfoConfig</a>	elementInfo↔ Config	AP broadcast it's capabilities (Such as CarPlay)
<a href="#">ApInterworking</a>	interworking	AP network access (internet/local)
<a href="#">ApSecurity</a>	apSecurity	AP Security settings
string	passPhrase	Passphrase for SSID used

#### 4.51.2.5 struct telux::wlan::ApConfig

Ap Configuration

##### Data fields

Type	Field	Description
<a href="#">Id</a>	id	AP id
<a href="#">ApVenueInfo</a>	venue	AP venue info
vector< <a href="#">Ap↔ NetConfig</a> >	network	Configurations supported by AP

#### 4.51.2.6 struct telux::wlan::DeviceIndInfo

Wlan Client Device Indication Info

##### Data fields

Type	Field	Description
<a href="#">Id</a>	id	AP id device is connected to
string	macAddress	MAC Address of Wi-Fi device

### 4.51.2.7 struct telux::wlan::DeviceInfo

Wlan Client Device Info

#### Data fields

Type	Field	Description
Id	id	AP id device is connected to
string	name	User friendly string that identifies Wi-Fi device
string	ipv4Address	IPv4 Address of Wi-Fi device
vector< string >	ipv6Address	List of IPv6 Addresses of Wi-Fi device
string	macAddress	MAC Address of Wi-Fi device

### 4.51.2.8 class telux::wlan::IApInterfaceManager

Manager class for configuring Wlan Access Points.

#### Public member functions

- virtual [telux::common::ErrorCode](#) setConfig (ApConfig config)=0
- virtual [telux::common::ErrorCode](#) setSecurityConfig (Id apId, ApSecurity apSecurity)=0
- virtual [telux::common::ErrorCode](#) setSsid (Id apId, std::string ssid)=0
- virtual [telux::common::ErrorCode](#) setVisibility (Id apId, bool isVisible)=0
- virtual [telux::common::ErrorCode](#) setElementInfoConfig (Id apId, ApElementInfoConfig config)=0
- virtual [telux::common::ErrorCode](#) setPassPhrase (Id apId, std::string passPhrase)=0
- virtual [telux::common::ErrorCode](#) getConfig (std::vector< ApConfig > &config)=0
- virtual [telux::common::ErrorCode](#) getStatus (std::vector< ApStatus > &status)=0
- virtual [telux::common::ErrorCode](#) getConnectedDevices (std::vector< DeviceInfo > &clientsInfo)=0
- virtual [telux::common::ErrorCode](#) manageApService (Id apId, ServiceOperation opr)=0
- virtual [telux::common::ErrorCode](#) registerListener (std::weak\_ptr< IApListener > listener)=0
- virtual [telux::common::ErrorCode](#) deregisterListener (std::weak\_ptr< IApListener > listener)=0
- virtual ~IApInterfaceManager ()

### 4.51.2.9 class telux::wlan::IApListener

#### Public member functions

- virtual void onApDeviceStatusChanged (ApDeviceConnectionEvent event, std::vector< DeviceIndInfo > info)
- virtual void onApBandChanged (BandType radio)
- virtual void onApConfigChanged (Id apId)

- virtual `~IApListener ()`

### 4.51.3 Enumeration Type Documentation

#### 4.51.3.1 enum telux::wlan::ApInterworking [strong]

AP Interworking Information

##### Enumerator

**INTERNET\_ACCESS** AP with internet access only - No LAN access  
**FULL\_ACCESS** AP Can Access LAN and Internet

#### 4.51.3.2 enum telux::wlan::ApDeviceConnectionEvent [strong]

AP Client Connection Status

##### Enumerator

**CONNECTED**  
**DISCONNECTED**  
**IPV4\_UPDATED**  
**IPV6\_UPDATED**

#### 4.51.3.3 enum telux::wlan::SecMode [strong]

Wlan Security Mode

##### Enumerator

**OPEN** Open System Architecture  
**WEP** Wired Equivalent Privacy  
**WPA** Wi-Fi Protected Access  
**WPA2** Wi-Fi Protected Access II  
**WPA3** Wi-Fi Protected Access III

#### 4.51.3.4 enum telux::wlan::SecAuth [strong]

Wlan Authentication Method

##### Enumerator

**NONE** No Authentication - Open System  
**PSK** Pre-Shared Key  
**EAP\_SIM** EAP - Subscriber Identity Module  
**EAP\_AKA** EAP - Authentication and Key Agreement  
**EAP\_LEAP** EAP - Lightweight Extensible Authentication Protocol  
**EAP\_TLS** EAP - Transport Layer Security  
**EAP\_TTLS** EAP - Tunneled Transport Layer Security  
**EAP\_PEAP** EAP - Protected EAP  
**EAP\_FAST** EAP - Flexible Authentication via Secure Tunneling  
**EAP\_PSK** EAP - Pre-Shared Key

**SAE** Simultaneous Authentication of Equals

### 4.51.3.5 enum telux::wlan::SecEncrypt [strong]

Wlan Encryption Method

#### Enumerator

**RC4** Rivest Cipher 4  
**TKIP** Temporal Key Integrity Protocol  
**AES** Advanced Encryption Standard  
**GCMP** Galois/Counter Mode Protocol

### 4.51.3.6 enum telux::wlan::NetAccessType [strong]

AP Network Access Type

#### Enumerator

**PRIVATE** Private Network  
**PRIVATE\_WITH\_GUEST** Private network with guest access  
**CHARGEABLE\_PUBLIC** Chargeable public network  
**FREE\_PUBLIC** Free public network  
**PERSONAL\_DEVICE** Personal device network  
**EMERGENCY\_SERVICES\_ONLY** Emergency services only network  
**TEST\_OR\_EXPERIMENTAL** Test or experimental  
**WILDCARD** Wildcard

## 4.51.4 Function Documentation

### 4.51.4.1 virtual telux::common::ErrorCode telux::wlan::IApInterfaceManager::setConfig ( ApConfig config ) [pure virtual]

Set Access Point config: Used to fully configure access points including venue type, radio type (2.4/5 GHz), private/guest network and all other related settings. Configurations will take effect after hostapd service is restarted by calling [telux::wlan::IApInterfaceManager::manageApService](#).

On platforms with Access control enabled, Caller needs to have TELUX\_WLAN\_AP\_CONFIG permission to invoke this API successfully.

#### Parameters

in	config	AP configuration parameters <a href="#">telux::wlan::ApConfig</a>
----	--------	---

#### Returns

operation error code (if any). [telux::common::ErrorCode](#) [telux::common::Status::NOTALLOWED](#) is returned if AP to be configured was not enabled in [telux::wlan::WlanDeviceManager::setMode](#).

**Note**

Eval: This is a new API and is being evaluated. It is subject to change and could break backwards compatibility.

#### 4.51.4.2 **virtual telux::common::ErrorCode telux::wlan::IApInterfaceManager::setSecurityConfig ( Id *apId*, ApSecurity *apSecurity* ) [pure virtual]**

Set Wlan Security Configuration: Used to change security settings of selected network.

**Parameters**

in	<i>apId</i>	AP identifier to set security for. <a href="#">telux::wlan::Id</a>
in	<i>apSecurity</i>	AP security settings. <a href="#">telux::wlan::ApSecurity</a>

**Returns**

operation error code (if any). [telux::common::ErrorCode](#)

**Note**

Eval: This is a new API and is being evaluated. It is subject to change and could break backwards compatibility.

#### 4.51.4.3 **virtual telux::common::ErrorCode telux::wlan::IApInterfaceManager::setSsid ( Id *apId*, std::string *ssid* ) [pure virtual]**

Set Access Point SSID: Used to change SSID of selected network.

**Parameters**

in	<i>apId</i>	AP identifier to set SSID for. <a href="#">telux::wlan::Id</a>
in	<i>ssid</i>	new SSID to be set

**Returns**

operation error code (if any). [telux::common::ErrorCode](#)

**Note**

Eval: This is a new API and is being evaluated. It is subject to change and could break backwards compatibility.

#### 4.51.4.4 **virtual telux::common::ErrorCode telux::wlan::IApInterfaceManager::setVisibility ( Id *apId*, bool *isVisible* ) [pure virtual]**

Set Access Point visibility: Used to change SSID broadcast of selected network.

**Parameters**

in	<i>apId</i>	AP identifier to set SSID visibility for. <a href="#">telux::wlan::Id</a>
in	<i>isVisible</i>	Visibility to be set

**Returns**

operation error code (if any). [telux::common::ErrorCode](#)

**Note**

Eval: This is a new API and is being evaluated. It is subject to change and could break backwards compatibility.

#### 4.51.4.5 virtual [telux::common::ErrorCode](#) [telux::wlan::IApInterfaceManager::setElementInfoConfig](#) ( *Id apId*, *ApElementInfoConfig config* ) [**pure virtual**]

Configure Element Info: Used to change element info configurations of selected network.

**Parameters**

in	<i>apId</i>	AP identifier to enable element info on. <a href="#">telux::wlan::Id</a>
in	<i>config</i>	Element Info configurations.

On platforms with Access control enabled, Caller needs to have TELUX\_WLAN\_AP\_DEVICES permission to invoke this API successfully.

**Returns**

operation error code (if any). [telux::common::ErrorCode](#)

**Note**

Eval: This is a new API and is being evaluated. It is subject to change and could break backwards compatibility.

#### 4.51.4.6 virtual [telux::common::ErrorCode](#) [telux::wlan::IApInterfaceManager::setPassPhrase](#) ( *Id apId*, *std::string passPhrase* ) [**pure virtual**]

Set Passphrase for Access Point: Used to change passphrase of selected network.

**Parameters**

in	<i>apId</i>	AP identifier to set passphrase for. <a href="#">telux::wlan::Id</a>
in	<i>passPhrase</i>	new passPhrase string

**Returns**

Immediate status of [setPassPhrase\(\)](#) request i.e. success or suitable status.

**Note**

Eval: This is a new API and is being evaluated. It is subject to change and could break backwards compatibility.

#### 4.51.4.7 **virtual telux::common::ErrorCode telux::wlan::IApInterfaceManager::get↔ Config ( std::vector< ApConfig > & config ) [pure virtual]**

Request Access Point Configurations

**Parameters**

in	<i>config</i>	Vector of AP configurations <a href="#">telux::wlan::ApConfig</a> as set by <a href="#">telux::wlan::IApInterfaceManager::setConfig</a>
----	---------------	---

**Returns**

operation error code (if any). [telux::common::ErrorCode](#)

**Note**

Eval: This is a new API and is being evaluated. It is subject to change and could break backwards compatibility.

#### 4.51.4.8 **virtual telux::common::ErrorCode telux::wlan::IApInterfaceManager::get↔ Status ( std::vector< ApStatus > & status ) [pure virtual]**

Request AP Status

**Parameters**

in	<i>status</i>	Vector of AP network Status <a href="#">telux::wlan::ApStatus</a>
----	---------------	---

**Returns**

operation error code (if any). [telux::common::ErrorCode](#)

**Note**

Eval: This is a new API and is being evaluated. It is subject to change and could break backwards compatibility.

#### 4.51.4.9 **virtual telux::common::ErrorCode telux::wlan::IApInterfaceManager::get↔ ConnectedDevices ( std::vector< DeviceInfo > & clientsInfo ) [pure virtual]**

Request Connected Devices to all enabled access points. Each entry in returned list will contain information about a device such as access point it is connected to and IP and MAC address as defined in [telux::wlan::DeviceInfo](#)

On platforms with Access control enabled, Caller needs to have TELUX\_WLAN\_AP\_DEVICES

permission to invoke this API successfully.

### Parameters

in	<i>clientsInfo</i>	List of connected devices Info <a href="#">telux::wlan::DeviceInfo</a>
----	--------------------	--

### Returns

operation error code (if any). [telux::common::ErrorCode](#)

### Note

Eval: This is a new API and is being evaluated. It is subject to change and could break backwards compatibility.

#### 4.51.4.10 virtual [telux::common::ErrorCode](#) [telux::wlan::IApInterfaceManager](#)↔ **::manageApService ( Id *apId*, ServiceOperation *opr* ) [pure virtual]**

Execute an operation on hostapd service. Provides ability for client to either stop/start or restart hostapd service for selected access point. Restarting hostapd service is required for any changes made to hostapd.conf file and changes made by [telux::wlan::IApInterfaceManager::setConfig](#) to take effect. Stop/Start operation [telux::wlan::ServiceOperation](#) will Stop/Start WiFi service for access point. Access points selected to execute operation on, will temporarily go out of service when this API is called. This API should be called only when access point is configured through

On platforms with Access control enabled, Caller needs to have TELUX\_WLAN\_AP\_CONFIG permission to invoke this API successfully.

[telux::wlan::IDeviceManager::setMode](#)

### Parameters

in	<i>apId</i>	AP identifier to execute operation on. <a href="#">telux::wlan::Id</a>
in	<i>opr</i>	Operation to be performed on hostapd <a href="#">telux::wlan::ServiceOperation</a>

### Returns

operation error code (if any). [telux::common::ErrorCode](#)

### Note

Eval: This is a new API and is being evaluated. It is subject to change and could break backwards compatibility.



**4.51.4.11** `virtual telux::common::ErrorCode telux::wlan::IApInterfaceManager↵  
::registerListener ( std::weak_ptr< IApListener > listener ) [pure  
virtual]`

Register a listener for specific events in Access Point Manager

#### Parameters

in	<i>listener</i>	pointer of <a href="#">IApListener</a> object that processes the notification
----	-----------------	---

#### Returns

operation error code (if any). [telux::common::ErrorCode](#)

**4.51.4.12** `virtual telux::common::ErrorCode telux::wlan::IApInterfaceManager↵  
::deregisterListener ( std::weak_ptr< IApListener > listener ) [pure  
virtual]`

Removes a previously added listener.

#### Parameters

in	<i>listener</i>	pointer of <a href="#">IApListener</a> object that needs to be removed
----	-----------------	--

#### Returns

operation error code (if any). [telux::common::ErrorCode](#)

**4.51.4.13** `virtual telux::wlan::IApInterfaceManager::~IApInterfaceManager ( )  
[virtual]`

**4.51.4.14** `virtual void telux::wlan::IApListener::onApDeviceStatusChanged (   
ApDeviceConnectionEvent event, std::vector< DeviceIndInfo > info )  
[virtual]`

This function is called when AP device status has changed

#### Parameters

in	<i>event</i>	Event detected on device <a href="#">telux::wlan::ApDeviceConnectionEvent</a>
in	<i>info</i>	Info about devices <a href="#">telux::wlan::DeviceIndInfo</a>

#### 4.51.4.15 virtual void telux::wlan::IApListener::onApBandChanged ( BandType *radio* ) [virtual]

This function is called when AP switch to different operation band

##### Parameters

in	<i>radio</i>	New AP operation band <a href="#">telux::wlan::BandType</a>
----	--------------	---

#### 4.51.4.16 virtual void telux::wlan::IApListener::onApConfigChanged ( Id *apid* ) [virtual]

This function is called when AP configuration has changed

##### Parameters

in	<i>apid</i>	<a href="#">telux::wlan::Id</a> of Ap it's configuration has changed
----	-------------	--

#### 4.51.4.17 virtual telux::wlan::IApListener::~~IApListener ( ) [virtual]

### 4.51.5 Variable Documentation

#### 4.51.5.1 int telux::wlan::ApVenueInfo::type

Venue Type

#### 4.51.5.2 int telux::wlan::ApVenueInfo::group

Venue Group

#### 4.51.5.3 SecMode telux::wlan::ApSecurity::mode

Security mode

#### 4.51.5.4 SecAuth telux::wlan::ApSecurity::auth

Authorization method

#### 4.51.5.5 SecEncrypt telux::wlan::ApSecurity::encrypt

Encryption method

#### 4.51.5.6 bool telux::wlan::ApElementInfoConfig::isEnabled

#### 4.51.5.7 bool telux::wlan::ApElementInfoConfig::isInterworkingEnabled

Interworking Service enablement

**4.51.5.8 NetAccessType telux::wlan::ApElementInfoConfig::netAccessType**

Network Access Type

**4.51.5.9 bool telux::wlan::ApElementInfoConfig::internet**

Whether network provide connectivity to internet

**4.51.5.10 bool telux::wlan::ApElementInfoConfig::asra**

Additional step required for access

**4.51.5.11 bool telux::wlan::ApElementInfoConfig::esr**

Emergency services reachable

**4.51.5.12 bool telux::wlan::ApElementInfoConfig::uesa**

Unauthenticated emergency service accessible

**4.51.5.13 uint8\_t telux::wlan::ApElementInfoConfig::venueGroup**

Venue group

**4.51.5.14 uint8\_t telux::wlan::ApElementInfoConfig::venueType**

Venue type

**4.51.5.15 std::string telux::wlan::ApElementInfoConfig::hessid**

Homogeneous ESS identifier

**4.51.5.16 std::string telux::wlan::ApElementInfoConfig::vendorElements**

Vendor elements for Beacon and Probe Response frames

**4.51.5.17 std::string telux::wlan::ApElementInfoConfig::assocRespElements**

Vendor elements for (Re)Association Response frames

**4.51.5.18 ApInfo telux::wlan::ApNetConfig::info**

AP type

**4.51.5.19 std::string telux::wlan::ApNetConfig::ssid**

SSID for AP

**4.51.5.20 bool telux::wlan::ApNetConfig::isVisible**

AP broadcast SSID

**4.51.5.21 ApElementInfoConfig telux::wlan::ApNetConfig::elementInfoConfig**

AP broadcast it's capabilities (Such as CarPlay)

**4.51.5.22 ApInterworking telux::wlan::ApNetConfig::interworking**

AP network access (internet/local)

**4.51.5.23 ApSecurity telux::wlan::ApNetConfig::apSecurity**

AP Security settings

**4.51.5.24 std::string telux::wlan::ApNetConfig::passPhrase**

Passphrase for SSID used

**4.51.5.25 Id telux::wlan::ApConfig::id**

AP id

**4.51.5.26 ApVenueInfo telux::wlan::ApConfig::venue**

AP venue info

**4.51.5.27 std::vector<ApNetConfig> telux::wlan::ApConfig::network**

Configurations supported by AP

**4.51.5.28 Id telux::wlan::DeviceIndInfo::id**

AP id device is connected to

**4.51.5.29 std::string telux::wlan::DeviceIndInfo::macAddress**

MAC Address of Wi-Fi device

**4.51.5.30 Id telux::wlan::DeviceInfo::id**

AP id device is connected to

**4.51.5.31 std::string telux::wlan::DeviceInfo::name**

User friendly string that identifies Wi-Fi device

**4.51.5.32 std::string telux::wlan::DeviceInfo::ipv4Address**

IPv4 Address of Wi-Fi device

**4.51.5.33 std::vector<std::string> telux::wlan::DeviceInfo::ipv6Address**

List of IPv6 Addresses of Wi-Fi device

**4.51.5.34 std::string telux::wlan::DeviceInfo::macAddress**

MAC Address of Wi-Fi device

## 4.52 Station Management

This section contains APIs related to station configuration management, such as static/dynamic IP, bridge/router mode, etc.

### 4.52.1 Data Structure Documentation

#### 4.52.1.1 struct telux::wlan::StaStaticIpConfig

Static IP Configuration

##### Data fields

Type	Field	Description
string	ipAddr	IPv4 address to be assigned.
string	gwIpAddr	IPv4 address of the gateway.
string	netMask	Subnet mask.
string	dnsAddr	DNS IPv4 address.

#### 4.52.1.2 struct telux::wlan::StaConfig

Station Configuration

##### Data fields

Type	Field	Description
<a href="#">Id</a>	staId	Id of station backhaul
<a href="#">StaIpConfig</a>	ipConfig	IP configuration of station backhaul
<a href="#">StaStaticIpConfig</a>	staticIpConfig	Static IP configuration if selected
<a href="#">StaBridgeMode</a>	bridgeMode	Station configuration as Router/bridge

#### 4.52.1.3 class telux::wlan::IStaInterfaceManager

Manager class for configuring Wlan Station Mode.

##### Public member functions

- virtual [telux::common::ErrorCode](#) setIpConfig (Id staId, [StaIpConfig](#) ipConfig, [StaStaticIpConfig](#) staticIpConfig)=0
- virtual [telux::common::ErrorCode](#) setBridgeMode (Id staId, [StaBridgeMode](#) bridgeMode)=0
- virtual [telux::common::ErrorCode](#) enableHotspot2 (Id staId, bool enable)=0
- virtual [telux::common::ErrorCode](#) getConfig (std::vector< [StaConfig](#) > &config)=0
- virtual [telux::common::ErrorCode](#) getStatus (std::vector< [StaStatus](#) > &status)=0
- virtual [telux::common::ErrorCode](#) manageStaService (Id staId, [ServiceOperation](#) opr)=0
- virtual [telux::common::ErrorCode](#) registerListener (std::weak\_ptr< [IStaListener](#) > listener)=0

- virtual [telux::common::ErrorCode](#) deregisterListener (std::weak\_ptr< [IStaListener](#) > listener)=0
- virtual [~IStaInterfaceManager](#) ()

#### 4.52.1.4 class telux::wlan::IStaListener

##### Public member functions

- virtual void [onStationStatusChanged](#) (std::vector< [StaStatus](#) > staStatus)
- virtual void [onStationBandChanged](#) ([BandType](#) radio)
- virtual [~IStaListener](#) ()

### 4.52.2 Enumeration Type Documentation

#### 4.52.2.1 enum telux::wlan::StaIpConfig [strong]

Station Connection IP Type

##### Enumerator

- DYNAMIC\_IP** Station is configured with dynamic IP  
**STATIC\_IP** Station is configured with Static IP

#### 4.52.2.2 enum telux::wlan::StaBridgeMode [strong]

Bridge/Router Mode

##### Enumerator

- ROUTER** Station is in Router Mode  
**BRIDGE** Station is in Bridge Mode

### 4.52.3 Function Documentation

#### 4.52.3.1 virtual telux::common::ErrorCode telux::wlan::IStaInterfaceManager::setIp↔ Config ( Id *stald*, [StaIpConfig](#) *ipConfig*, [StaStaticIpConfig](#) *staticIpConfig* ) [pure virtual]

Set Station IP Configurations: Set Station IP configuration dynamic/static and static IP address if selected. If API is called when WLAN is disabled, changes will take effect when WLAN is enabled using [telux::wlan::IWlanDeviceManager::enable](#) API. If API is called when WLAN is enabled, changes will take effect after restarting wpa\_supplicant by calling [telux::wlan::IStaInterfaceManager::manageStaService](#)

##### Parameters

in	<i>stald</i>	Station Identifier <a href="#">telux::wlan::Id</a>
in	<i>ipConfig</i>	Static/Dynamic IP configuration <a href="#">telux::wlan::StaIpConfig</a> .
in	<i>staticIpConfig</i>	Static IP configuration, not used if station was configured to use dynamic IP.

On platforms with Access control enabled, Caller needs to have `TELUX_WLAN_STA_CONFIG` permission to invoke this API successfully.

### Returns

operation error code (if any). [telux::common::ErrorCode](#).

### Note

Eval: This is a new API and is being evaluated. It is subject to change and could break backwards compatibility.

#### 4.52.3.2 virtual `telux::common::ErrorCode telux::wlan::IStaInterfaceManager::setBridgeMode ( Id staId, StaBridgeMode bridgeMode ) [pure virtual]`

Set Station backhaul to act as router or bridge: Sets Station to act as router or bridge where station internal clients get public IP addresses. If API is called when WLAN is disabled, changes will take effect when WLAN is enabled using [telux::wlan::IWlanDeviceManager::enable](#) API. If API is called when WLAN is enabled, changes will take effect after restarting wpa\_supplicant by calling [telux::wlan::IStaInterfaceManager::manageStaService](#)

On platforms with Access control enabled, Caller needs to have `TELUX_WLAN_STA_CONFIG` permission to invoke this API successfully.

### Parameters

in	<i>staId</i>	Station Identifier <a href="#">telux::wlan::Id</a>
in	<i>bridgeMode</i>	bridgeMode <a href="#">telux::wlan::StaBridgeMode</a>

### Returns

operation error code (if any). [telux::common::ErrorCode](#).

### Note

Eval: This is a new API and is being evaluated. It is subject to change and could break backwards compatibility.

#### 4.52.3.3 virtual `telux::common::ErrorCode telux::wlan::IStaInterfaceManager::enableHotspot2 ( Id staId, bool enable ) [pure virtual]`

Enable Hotspot 2.0 Support

### Parameters

in	<i>staId</i>	Station Identifier <a href="#">telux::wlan::Id</a>
in	<i>enable</i>	True: enable Hotspot support, False disable support



**Returns**

operation error code (if any). [telux::common::ErrorCode](#).

**Note**

Eval: This is a new API and is being evaluated. It is subject to change and could break backwards compatibility.

#### 4.52.3.4 **virtual telux::common::ErrorCode telux::wlan::IStaInterfaceManager::get← Config ( std::vector< StaConfig > & config ) [pure virtual]**

Request current station configurations: Returns configurations set by [telux::wlan::IStaInterfaceManager::setIpConfig](#) and [telux::wlan::IStaInterfaceManager::setBridgeMode](#)

**Parameters**

in	<i>config</i>	Station configurations <a href="#">telux::wlan::StaConfig</a>
----	---------------	---

**Returns**

operation error code (if any). [telux::common::ErrorCode](#).

**Note**

Eval: This is a new API and is being evaluated. It is subject to change and could break backwards compatibility.

#### 4.52.3.5 **virtual telux::common::ErrorCode telux::wlan::IStaInterfaceManager::get← Status ( std::vector< StaStatus > & status ) [pure virtual]**

Request current station status: Returns current Sta interface status such as network interface name and IP address.

**Parameters**

in	<i>status</i>	Station Status <a href="#">telux::wlan::StaStatus</a>
----	---------------	---

**Returns**

operation error code (if any). [telux::common::ErrorCode](#).

**Note**

Eval: This is a new API and is being evaluated. It is subject to change and could break backwards compatibility.

#### 4.52.3.6 virtual telux::common::ErrorCode telux::wlan::IStaInterfaceManager↔ ::manageStaService ( Id *stald*, ServiceOperation *opr* ) [pure virtual]

Execute an operation on wpa\_supplicant service. Provides ability for client to either stop/start or restart wpa\_supplicant service for selected station. Restarting wpa\_supplicant service is required for any changes made to wpa\_supplicant.conf file to take effect. Station selected to execute operation on, will temporarily go out of service when this API is called. This API should be called only when station mode is configured through telux::wlan::IDeviceManager::setMode

On platforms with Access control enabled, Caller needs to have TELUX\_WLAN\_STA\_CONFIG permission to invoke this API successfully.

##### Parameters

in	<i>stald</i>	Station identifier to execute operation on. <a href="#">telux::wlan::Id</a>
in	<i>opr</i>	Operation to be performed on wpa_supplicant <a href="#">telux::wlan::ServiceOperation</a>

##### Returns

operation error code (if any). [telux::common::ErrorCode](#).

##### Note

Eval: This is a new API and is being evaluated. It is subject to change and could break backwards compatibility.

#### 4.52.3.7 virtual telux::common::ErrorCode telux::wlan::IStaInterfaceManager↔ ::registerListener ( std::weak\_ptr< IStaListener > *listener* ) [pure virtual]

Register as a listener for specific events defined in [telux::wlan::IStaListener](#)

##### Parameters

in	<i>listener</i>	pointer of <a href="#">IStaListener</a> object that processes the notification
----	-----------------	--

##### Returns

operation error code (if any). [telux::common::ErrorCode](#).

#### 4.52.3.8 virtual telux::common::ErrorCode telux::wlan::IStaInterfaceManager↔ ::deregisterListener ( std::weak\_ptr< IStaListener > *listener* ) [pure virtual]

Removes a previously added listener.

**Parameters**

in	<i>listener</i>	pointer of <a href="#">IStaListener</a> object that needs to be removed
----	-----------------	---

**Returns**

operation error code (if any). [telux::common::ErrorCode](#).

**4.52.3.9 virtual telux::wlan::IStaInterfaceManager::~~IStaInterfaceManager ( ) [virtual]**

**4.52.3.10 virtual void telux::wlan::IStaListener::onStationStatusChanged ( std::vector< StaStatus > *staStatus* ) [virtual]**

This function is called when Station Status Changes

**Parameters**

in	<i>status</i>	List of station state <a href="#">telux::wlan::StaStatus</a>
----	---------------	--

**4.52.3.11 virtual void telux::wlan::IStaListener::onStationBandChanged ( BandType *radio* ) [virtual]**

This function is called when Station switch to different operation band

**Parameters**

in	<i>radio</i>	New Station operation band <a href="#">telux::wlan::BandType</a>
----	--------------	--

**4.52.3.12 virtual telux::wlan::IStaListener::~~IStaListener ( ) [virtual]**

**4.52.4 Variable Documentation**

**4.52.4.1 std::string telux::wlan::StaStaticIpConfig::ipAddr**

IPv4 address to be assigned.

**4.52.4.2 std::string telux::wlan::StaStaticIpConfig::gwIpAddr**

IPv4 address of the gateway.

**4.52.4.3 std::string telux::wlan::StaStaticIpConfig::netMask**

Subnet mask.

**4.52.4.4 std::string telux::wlan::StaStaticIpConfig::dnsAddr**

DNS IPv4 address.

**4.52.4.5 Id telux::wlan::StaConfig::stald**

Id of station backhaul

**4.52.4.6 StalpConfig telux::wlan::StaConfig::ipConfig**

IP configuration of station backhaul

**4.52.4.7 StaStaticIpConfig telux::wlan::StaConfig::staticIpConfig**

Static IP configuration if selected

**4.52.4.8 StaBridgeMode telux::wlan::StaConfig::bridgeMode**

Station configuration as Router/bridge

## 4.53 Diagnostics Services

This section contains APIs related to diagnostics services.

### 4.53.1 Data Structure Documentation

#### 4.53.1.1 struct telux::platform::diag::DiagStatus

Current diagnostic status

##### Data fields

Type	Field	Description
<a href="#">LogMethod</a>	logMethod	Current successfully configured logging method
bool	isLoggingIn↔ Progress	True: If logging has already started. False otherwise
bool	isLogDrainIn↔ Progress	True: If log drain has already started. False otherwise

#### 4.53.1.2 union telux::platform::diag::SourceInfo

Configure device(s) or peripheral(s) from which logs to be collected. Logging source can be either device level or peripheral level.

##### Data fields

Type	Field	Description
<a href="#">Devices</a>	device	telux::platform::diag::Device
<a href="#">Peripherals</a>	peripheral	telux::platform::diag::Peripheral

#### 4.53.1.3 struct telux::platform::diag::FileMethodConfig

Represents the config relevant to File method. Logs are saved to a file under the directory specified by platform.diag.diag\_output\_log\_path in tel.conf file. if Key does not exist, log will be stored in default location /tmp/diag.

##### Data fields

Type	Field	Description
uint32_t	maxSize	Optional. Maximum file size in MB after which it will create a new file. The maximum size should not exceed MAX_DIAG_FILE_SIZE_MB.
uint32_t	maxNumber	Optional. Maximum number of log files. Files are replaced once this number is reached. The maximum value should not exceed MAX_NUM_DIAG_FILES

#### 4.53.1.4 struct telux::platform::diag::DiagConfig

##### Data fields

Type	Field	Description
<a href="#">SourceType</a>	srcType	<a href="#">telux::platform::diag::SourceType</a>
<a href="#">SourceInfo</a>	srcInfo	<a href="#">telux::platform::diag::SourceInfo</a> . Based on the source type selected in <a href="#">DiagConfig.srcType</a> , the corresponding field in <a href="#">DiagConfig.srcInfo</a> would be valid.
string	mdmLog↔ MaskFile	Optional - Full path to file that contains the MDM mask to filter logs. It is generated using QxDM and can be either cfg or cfg2 format. Needed only if logs are generated from MDM device or MDM peripherals
string	eapLogMask↔ File	Optional - Full path to file that contains the EAP mask to filter logs. It is generated using QxDM and can be either cfg or cfg2 format. Needed only if logs are generated from EAP device or EAP peripherals
<a href="#">DiagLogMode</a>	modeType	<a href="#">telux::platform::diag::DiagLogMode</a>
<a href="#">LogMethod</a>	method	<a href="#">telux::platform::diag::LogMethod</a>
union <a href="#">MethodConfig</a>	methodConfig	

#### 4.53.1.5 class telux::platform::diag::IDiagLogManager

[IDiagLogManager](#) is a primary interface for Diagnostics. The interface offers APIs to configure log collection method (File or Callback) and configure log mode for selected method (streaming, threshold, or circular). The interface also provides APIs to start and stop diagnostics log collection in configured method and mode.

##### Public member functions

- virtual [DiagStatus](#) [getStatus](#) ()=0
- virtual [telux::common::Status](#) [registerListener](#) (std::weak\_ptr< [IDiagListener](#) > listener)=0
- virtual [telux::common::Status](#) [deregisterListener](#) (std::weak\_ptr< [IDiagListener](#) > listener)=0
- virtual [telux::common::ErrorCode](#) [setConfig](#) (const [DiagConfig](#) config)=0
- virtual [DiagConfig](#) [getConfig](#) ()=0
- virtual [telux::common::ErrorCode](#) [startDrainingLogs](#) ()=0
- virtual [telux::common::ErrorCode](#) [stopDrainingLogs](#) ()=0
- virtual [telux::common::ErrorCode](#) [startLogCollection](#) ()=0
- virtual [telux::common::ErrorCode](#) [stopLogCollection](#) ()=0
- virtual [~IDiagLogManager](#) ()

### 4.53.1.5.1 Constructors and Destructors

4.53.1.5.1.1 `virtual telux::platform::diag::IDiagLogManager::~~IDiagLogManager ( ) [virtual]`

Destructor for [IDiagLogManager](#)

### 4.53.1.5.2 Member Function Documentation

4.53.1.5.2.1 `virtual DiagStatus telux::platform::diag::IDiagLogManager::getStatus ( ) [pure virtual]`

Returns the current status of logging subsystem.

#### Returns

Status of logging subsystem [telux::platform::diag::DiagStatus](#)

#### Note

Eval: This is a new API and is being evaluated. It is subject to change and could break backwards compatibility.

4.53.1.5.2.2 `virtual telux::common::Status telux::platform::diag::IDiagLogManager::registerListener ( std::weak_ptr< IDiagListener > listener ) [pure virtual]`

Register a listener for specific events in the Diag log Manager like availability of logs, checking for unexpected error.

#### Parameters

in	<i>listener</i>	Pointer of <a href="#">IDiagListener</a> object that processes the notification
----	-----------------	---

#### Returns

Status of registerListener success or suitable status code

#### Note

Eval: This is a new API and is being evaluated. It is subject to change and could break backwards compatibility.

4.53.1.5.2.3 `virtual telux::common::Status telux::platform::diag::IDiagLogManager::deregisterListener ( std::weak_ptr< IDiagListener > listener ) [pure virtual]`

Removes a previously added listener.

**Parameters**

in	<i>listener</i>	Pointer of <a href="#">IDiagListener</a> object that needs to be removed
----	-----------------	--

**Returns**

Status of deregisterListener success or suitable status code

**Note**

Eval: This is a new API and is being evaluated. It is subject to change and could break backwards compatibility.

#### 4.53.1.5.2.4 virtual `telux::common::ErrorCode telux::platform::diag::IDiagLogManager::setConfig ( const DiagConfig config ) [pure virtual]`

Sets the logging configurations.

This API must be called when logging is not in progress. Calling this API while logging has already started will return `telux::common::ErrorCode::INVALID_STATE` error. If error is returned, clients need to invoke the API again with the correct parameters.

On platforms with Access control enabled, Caller needs to have TELUX\_DIAG\_OPS permission to invoke this API successfully.

**Parameters**

in	<i>config</i>	<a href="#">telux::platform::diag::DiagConfig</a>
----	---------------	---

**Returns**

Return code for whether the operation succeeded or failed [telux::common::ErrorCode](#)

**Note**

Eval: This is a new API and is being evaluated. It is subject to change and could break backwards compatibility.

#### 4.53.1.5.2.5 virtual `DiagConfig telux::platform::diag::IDiagLogManager::getConfig ( ) [pure virtual]`

Get current configuration settings

**Returns**

current log configuration [telux::platform::diag::DiagConfig](#).



**Note**

Eval: This is a new API and is being evaluated. It is subject to change and could break backwards compatibility.

**4.53.1.5.2.6 virtual telux::common::ErrorCode telux::platform::diag::IDiagLogManager::startDrainingLogs ( ) [pure virtual]**

Starts draining the logs from the circular buffer. Until `telux::platform::diag::stopDrainingLogs` is called, logs will continue to be written to circular buffer, getting flushed and written to log file or provided to client via `telux::platform::diag::IDiagListener::onAvailableLogs` based on selected logging method `telux::platform::diag::LogMethod`. If this API is called while logging has not started, `telux::common::ErrorCode::INVALID_STATE` error is returned. Attempt to call this API while draining log is already in progress, will not affect the state of logging and will return `telux::common::ErrorCode::NO_EFFECT` error.

This API should be used only in circular buffering mode.

On platforms with Access control enabled, Caller needs to have `TELUX_DIAG_OPS` permission to invoke this API successfully.

**Returns**

Return code for whether the operation succeeded or failed `telux::common::ErrorCode`

**Note**

Eval: This is a new API and is being evaluated. It is subject to change and could break backwards compatibility.

**4.53.1.5.2.7 virtual telux::common::ErrorCode telux::platform::diag::IDiagLogManager::stopDrainingLogs ( ) [pure virtual]**

Stops the draining of logs and continues collecting logs in circular buffer mode. This API should be used only in circular buffering mode. If this API is called while logging has not started `telux::common::ErrorCode::INVALID_STATE` error is returned. Attempt to call this API while draining log is not in progress, will not affect the state of logging and will return `telux::common::ErrorCode::NO_EFFECT` error.

On platforms with Access control enabled, Caller needs to have `TELUX_DIAG_OPS` permission to invoke this API successfully.

**Returns**

Return code for whether the operation succeeded or failed `telux::common::ErrorCode`

**Note**

Eval: This is a new API and is being evaluated. It is subject to change and could break backwards compatibility.

#### 4.53.1.5.2.8 **virtual telux::common::ErrorCode telux::platform::diag::IDiagLogManager::startLogCollection ( ) [pure virtual]**

Start the Log collection session This API starts the log collection. It is expected the configuration to be set successfully via [telux::platform::diag::IDiagLogManager::setConfig](#) before calling this API. Calling this API after logging has already started will not affect logging state and will return [telux::common::ErrorCode::NO\\_EFFECT](#) error.

On platforms with Access control enabled, Caller needs to have TELUX\_DIAG\_OPS permission to invoke this API successfully.

##### **Returns**

Return code for whether the operation succeeded or failed [telux::common::ErrorCode](#) Error is returned if configuration is not set correctly.

##### **Note**

Eval: This is a new API and is being evaluated. It is subject to change and could break backwards compatibility.

#### 4.53.1.5.2.9 **virtual telux::common::ErrorCode telux::platform::diag::IDiagLogManager::stopLogCollection ( ) [pure virtual]**

Stop the Log collection session

On platforms with Access control enabled, Caller needs to have TELUX\_DIAG\_OPS permission to invoke this API successfully.

##### **Returns**

Return code for whether the operation succeeded or failed [telux::common::ErrorCode](#)

##### **Note**

Eval: This is a new API and is being evaluated. It is subject to change and could break backwards compatibility.

### 4.53.1.6 **class telux::platform::diag::IDiagListener**

Interface for Diag listener object. Client needs to implement this interface to get access to diag log service notifications like onAvailableLogs, onError.

The methods in listener can be invoked from multiple different threads. The implementation should be thread safe.

The notification delivery mechanism uses the same thread to deliver all the queued notifications to ensure they are delivered in order. Considering this, the thread on which the notifications are delivered should not be blocked for longer operations since this would result in delay in delivery of further notifications that are in the queue waiting to be dispatched.

**Public member functions**

- virtual void [onAvailableLogs](#) (uint8\_t \*ptr, int len)
- virtual [~IDiagListener](#) ()

**4.53.1.6.1 Constructors and Destructors**

**4.53.1.6.1.1** virtual [telux::platform::diag::IDiagListener::~~IDiagListener](#) ( ) [virtual]

Destructor for [IDiagListener](#)

**4.53.1.6.2 Member Function Documentation**

**4.53.1.6.2.1** virtual void [telux::platform::diag::IDiagListener::onAvailableLogs](#) ( uint8\_t \* *ptr*, int *len* ) [virtual]

Invoked when logs are available in callback method to when they are available.

**Parameters**

in	<i>ptr</i>	Pointer to the log data
in	<i>len</i>	Length of the data

**4.53.1.7 class [telux::platform::diag::DiagnosticsFactory](#)**

[DiagnosticsFactory](#) is the central factory to create Diagnostics manager class.

**Public member functions**

- virtual std::shared\_ptr< [IDiagLogManager](#) > [getDiagLogManager](#) ([telux::common::InitResponseCb](#) clientCallback=nullptr)=0

**Static Public Member Functions**

- static [DiagnosticsFactory](#) & [getInstance](#) ()

**Protected Member Functions**

- [DiagnosticsFactory](#) ()
- virtual [~DiagnosticsFactory](#) ()

**4.53.1.7.1 Constructors and Destructors**

**4.53.1.7.1.1** [telux::platform::diag::DiagnosticsFactory::DiagnosticsFactory](#) ( ) [protected]

**4.53.1.7.1.2** `virtual telux::platform::diag::DiagnosticsFactory::~DiagnosticsFactory ( )`  
`[protected], [virtual]`

#### 4.53.1.7.2 Member Function Documentation

**4.53.1.7.2.1** `static DiagnosticsFactory& telux::platform::diag::DiagnosticsFactory::getInstance ( )`  
`[static]`

Get Diagnostics Factory instance.

**4.53.1.7.2.2** `virtual std::shared_ptr<IDiagLogManager> telux::platform::diag::DiagnosticsFactory↵  
 ::getDiagLogManager ( telux::common::InitResponseCb clientCallback = nullptr )`  
`[pure virtual]`

Get Diagnostics Manager

#### Returns

instance of [IDiagLogManager](#)

## 4.53.2 Enumeration Type Documentation

**4.53.2.1** `enum telux::platform::diag::DiagLogMode [strong]`

Specifies the mode of logging to be used (Streaming, threshold, circular buffer)

#### Enumerator

**STREAMING** Logs are flushed immediately from the buffer when available. Logs are saved to a file (in file method) or passed to the client in real time through listener [IDiagListener::onAvailableLogs\(\)](#) (in callback method)

**THRESHOLD** Can be used to conserve power. Logs are flushed out when the buffer is full. This is only applicable to peripherals with its own buffer such as Modem DSP. It is not recommended to enable too many logs in logmask file passed to `telux::platform::diag::setConfig` API. Too many logs will cause frequent processor wake ups and consequently result in the threshold being crossed and logs being flushed frequently resembling streaming mode.

**CIRCULAR\_BUFFER** Can be used to conserve power. Logs are continuously written to a buffer until client triggers buffer drain command to collect the logs. This is only applicable to peripherals with its own buffer such as Modem DSP. Old logs are overwritten when buffer is full. Logs in the buffer will be flushed only upon client's request.

**4.53.2.2** `enum telux::platform::diag::DeviceType`

Enables log collection from selected device(s) which includes logs from Integrated AP and all peripherals on the device. Note: If device logging is enabled, peripheral logging must be disabled.

#### Enumerator

**DIAG\_DEVICE\_NONE** Device logging is disabled. Only peripheral logging on device application is running on is enabled

**DIAG\_DEVICE\_EXTERNAL\_AP** Log collection from External Application Processor is enabled

**DIAG\_DEVICE\_MDM** Log collection from MDM is enabled

#### 4.53.2.3 enum telux::platform::diag::PeripheralType

Enables log collection from selected peripheral (if it exists) and/or application processor in the device where the client of the API is running. Note: If peripheral logging is enabled, device logging must be disabled.

##### Enumerator

**DIAG\_PERIPHERAL\_NONE** Disable peripherals log collection

**DIAG\_PERIPHERAL\_INTEGRATED\_AP** Enable integrated AP log collection. On platforms where hypervisor is present, this indicates logs from PVM

**DIAG\_PERIPHERAL\_MODEM\_DSP** Enable modem DSP log collection

**DIAG\_PERIPHERAL\_SVM** Enable log collection on all SVMs

**DIAG\_PERIPHERAL\_LPASS** Enable LPASS log collection

**DIAG\_PERIPHERAL\_CDSP** Enable CDSP log collection

#### 4.53.2.4 enum telux::platform::diag::LogMethod [strong]

Diagnostic logging methods. Only one logging method can be selected

##### Enumerator

**NONE** No valid logging method

**FILE** File logging method. Collected Logs will be saved to file located under platform.diag.diag\_output\_log\_path key in tel.conf file or under /tmp/diag if such key does not exist

**CALLBACK** Callback logging method. Collected logs are provided to clients via [telux::platform::diag::IDiagListener::onAvailableLogs](#)

#### 4.53.2.5 enum telux::platform::diag::SourceType [strong]

Diagnostic log source. When device level logging is selected from telux::platform::diag::Device and logs from all peripherals in such device will be collected. When peripheral logging is selected from telux::platform::diag::Peripheral, logs from selected peripherals will be collected.

##### Enumerator

**NONE** No valid logging source

**DEVICE** Device level logging source.

**PERIPHERAL** Peripheral level logging source

## 4.54 Cellular Data

- [net](#)

This section contains APIs related to Cellular Data Services.

### 4.54.1 Define Documentation

#### 4.54.1.1 #define PROFILE\_ID\_MAX 0x7FFFFFFF

Default data profile id.

#### 4.54.1.2 #define MAX\_QOS\_FILTERS 16

Max filters in one flow

#### 4.54.1.3 #define IP\_PROT\_UNKNOWN 0xFF

Default IP Protocol number in IPv4 or IPv6 headers.

### 4.54.2 Data Structure Documentation

#### 4.54.2.1 struct telux::data::DataUsage

Data usage statistics.

##### Data fields

Type	Field	Description
uint64_t	bytesRx	Bytes received by client
uint64_t	bytesTx	Bytes transmitted by client .

#### 4.54.2.2 struct telux::data::DeviceDataUsage

Data usage statistics for device.

##### Data fields

Type	Field	Description
string	macAddress	MAC address of the client.
<a href="#">DataUsage</a>	usage	Data usage statistics

#### 4.54.2.3 class telux::data::IClientManager

Client Manager class provides APIs related to devices and clients connected to MDM via different interconnects. A device is any entity with a unique MAC address that is connected to the MDM and clients are characterized by unique IP address. Clients could also be connected over VLANs. Interconnects can be wired (e.g. Ethernet) or wireless (e.g. WLAN).

**Public member functions**

- virtual `telux::common::ServiceStatus getServiceStatus ()=0`
- virtual `telux::common::Status registerListener (std::weak_ptr< IClientListener > listener)=0`
- virtual `telux::common::Status deregisterListener (std::weak_ptr< IClientListener > listener)=0`
- virtual `telux::common::ErrorCode getDeviceDataUsageStats (std::vector< DeviceDataUsage > &usageStats)=0`
- virtual `telux::common::ErrorCode resetDataUsageStats ()=0`

**4.54.2.3.1 Member Function Documentation****4.54.2.3.1.1 virtual `telux::common::ServiceStatus telux::data::IClientManager::getServiceStatus ( )` [pure virtual]**

Checks the status of Client manager object and returns the result.

**Returns**

SERVICE\_AVAILABLE - If Client manager object is ready for service.

SERVICE\_UNAVAILABLE - If Client manager object is temporarily unavailable.

SERVICE\_FAILED - If Client manager object encountered an irrecoverable failure.

**Note**

Eval: This is a new API and is being evaluated. It is subject to change and could break backwards compatibility.

**4.54.2.3.1.2 virtual `telux::common::Status telux::data::IClientManager::registerListener ( std::weak_ptr< IClientListener > listener )` [pure virtual]**

Register listener with client manager for service status events and other notifications

**Parameters**

in	<i>listener</i>	pointer of <code>IClientListener</code> object that processes the notification
----	-----------------	--

**Returns**

Status of registerListener success or suitable status code

**4.54.2.3.1.3 virtual `telux::common::Status telux::data::IClientManager::deregisterListener ( std::weak_ptr< IClientListener > listener )` [pure virtual]**

Removes a previously added listener.

**Parameters**

in	<i>listener</i>	pointer of <a href="#">IClientListener</a> object that needs to be removed
----	-----------------	--

**Returns**

Status of deregisterListener success or suitable status code

#### 4.54.2.3.1.4 **virtual telux::common::ErrorCode telux::data::IClientManager::getDeviceDataUsageStats ( std::vector< DeviceDataUsage > & usageStats ) [pure virtual]**

Get data usage for connected devices

This API provides the usage of a backhaul (e.g. cellular WWAN connection) on the MDM by various devices. The usage does not include any traffic sent between devices within the same vehicle. A device is any entity with a unique MAC address that is connected to the MDM either over a wired or wireless interconnect. Device data usage monitoring should be enabled for this api to work. Status of device data usage monitoring can be obtained by using [telux::data::IDataSettingsManager::isDeviceDataUsageMonitoringEnabled](#).

Statistics are reset when a backhaul switch occurs, such as switching from a WWAN interface to a WLAN interface. In this case the last known statistics of the device before the reset will be provided via [IClientListener::onDeviceDataUsageResetImminent](#). The statistics can also be explicitly reset using [IClientManager::resetDataUsageStats](#). In this case, no notification will be sent about the last known statistics before reset.

On platforms with access control enabled, the caller needs to have TELUX\_DATA\_CLIENT\_INFO permission to successfully invoke this API.

**Parameters**

out	<i>usageStats</i>	List of data usage information, per device.
-----	-------------------	---

**Returns**

Return code for whether the operation succeeded or failed. If usage monitoring is not enabled, INVALID\_STATE is returned.

#### 4.54.2.3.1.5 **virtual telux::common::ErrorCode telux::data::IClientManager::resetDataUsageStats ( ) [pure virtual]**

Reset data usage statistics

The data reported via [IClientManager::getDeviceDataUsageStats](#) will be reset once this API is called.

On platforms with access control enabled, the caller needs to have TELUX\_DATA\_CLIENT\_CONFIG permission to successfully invoke this API.

**Returns**

Return code for whether the operation succeeded or failed. If usage monitoring is not enabled, INVALID\_STATE is returned.



#### 4.54.2.4 class telux::data::IClientListener

Interface for Client listener. Client needs to implement this interface to get access to Client services notifications like onServiceStatusChange.

The methods in listener can be invoked from multiple different threads. The implementation should be thread safe.

##### Public member functions

- virtual void `onServiceStatusChange` (`telux::common::ServiceStatus` status)
- virtual void `onDeviceDataUsageResetImminent` (`const std::vector< DeviceDataUsage >` usageStats, `UsageResetReason` reason)
- virtual `~IClientListener` ()

##### 4.54.2.4.1 Constructors and Destructors

###### 4.54.2.4.1.1 virtual telux::data::IClientListener::~~IClientListener ( ) [virtual]

Destructor for `IClientListener`

##### 4.54.2.4.2 Member Function Documentation

###### 4.54.2.4.2.1 virtual void telux::data::IClientListener::onServiceStatusChange ( telux::common::↔ ServiceStatus *status* ) [virtual]

This function is called when service status changes.

##### Parameters

in	<i>status</i>	- <code>ServiceStatus</code>
----	---------------	------------------------------

###### 4.54.2.4.2.2 virtual void telux::data::IClientListener::onDeviceDataUsageResetImminent ( const std::vector< DeviceDataUsage > *usageStats*, `UsageResetReason` *reason* ) [virtual]

Provides the last known statistics of a connected device, before the statistics become unavailable or are reset.

On platforms with access control enabled, the caller needs to have `TELUX_DATA_CLIENT_INFO` permission to successfully invoke this API.

##### Parameters

in	<i>usageStats</i>	List of disconnected device(with a unique MAC) data usage
in	<i>reason</i>	The event/reason that triggered the data usage reset

#### 4.54.2.5 struct telux::data::IpFamilyInfo

IP Family related Info

##### Data fields

Type	Field	Description
<a href="#">DataCallStatus</a>	status	
<a href="#">IpAddrInfo</a>	addr	

#### 4.54.2.6 struct telux::data::QosFilterRule

Encapsulate the Qos Filter rule

##### Data fields

Type	Field	Description
vector< shared_ptr< <a href="#">IpFilter</a> > >	filter	<a href="#">IpFilter</a>
uint16_t	filterId	Unique identifier for each filter.
uint16_t	filterPrecedence	Specifies the order in which filters are applied. A lower numerical value has a higher precedence.

#### 4.54.2.7 struct telux::data::TrafficFlowTemplate

QOS TFT Flow info

##### Data fields

Type	Field	Description
<a href="#">QosFlowId</a>	qosId	Mandatory defines current flow id
<a href="#">QosFlow↔ StateChange↔ Event</a>	stateChange	Flow state change event
<a href="#">QosFlowMask</a>	mask	bitmask to denote which of the optional fields in <a href="#">TrafficFlowTemplate</a> are valid
<a href="#">QosIPFlowInfo</a>	txGrantedFlow	Optional
<a href="#">QosIPFlowInfo</a>	rxGrantedFlow	
uint32_t	txFiltersLength	
<a href="#">QosFilterRule</a>	txFilters[ <a href="#">MA↔ X_QOS_FIL↔ TERS</a> ]	
uint32_t	rxFiltersLength	
<a href="#">QosFilterRule</a>	rxFilters[ <a href="#">MA↔ X_QOS_FIL↔ TERS</a> ]	

#### 4.54.2.8 struct telux::data::TftChangeInfo

QOS TFT flow change info

##### Data fields

Type	Field	Description
shared_ptr< <a href="#">TrafficFlow</a> ↔ <a href="#">Template</a> >	tft	TFT flow info <a href="#">TrafficFlowTemplate</a>
<a href="#">QosFlow</a> ↔ <a href="#">StateChange</a> ↔ <a href="#">Event</a>	stateChange	Flow state change event

#### 4.54.2.9 struct telux::data::BitRateInfo

Data call bit rate info

##### Data fields

Type	Field	Description
uint64_t	txRate	<b>Deprecated</b> Unused
uint64_t	rxRate	<b>Deprecated</b> Unused
uint64_t	maxTxRate	Maximum transmit rate that can be assigned to device in bits/sec
uint64_t	maxRxRate	Maximum receive rate that can be assigned to device in bits/sec

#### 4.54.2.10 class telux::data::IDataConnectionManager

[IDataConnectionManager](#) is a primary interface for cellular connectivity This interface provides APIs for start and stop data call connections, get data call information and listener for monitoring data calls. It also provides interface to Subsystem Restart events by registering as listener. Notifications will be received when modem is ready/not ready.

##### Public member functions

- virtual [telux::common::ServiceStatus](#) getServiceStatus ()=0
- virtual bool isSubsystemReady ()=0
- virtual std::future< bool > onSubsystemReady ()=0

- virtual `telux::common::Status setDefaultProfile (OperationType operationType, uint8_t profileId, telux::common::ResponseCallback callback=nullptr)=0`
- virtual `telux::common::Status getDefaultProfile (OperationType operationType, DefaultProfileIdResponseCb callback)=0`
- virtual `telux::common::Status setRoamingMode (bool enable, uint8_t profileId, OperationType operationType, telux::common::ResponseCallback callback=nullptr)=0`
- virtual `telux::common::Status requestRoamingMode (uint8_t profileId, OperationType operationType, requestRoamingModeResponseCb callback)=0`
- virtual `telux::common::Status startDataCall (int profileId, IpFamilyType ipFamilyType=IpFamilyType::IPV4V6, DataCallResponseCb callback=nullptr, OperationType operationType=OperationType::DATA_LOCAL, std::string apn="")=0`
- virtual `telux::common::Status stopDataCall (int profileId, IpFamilyType ipFamilyType=IpFamilyType::IPV4V6, DataCallResponseCb callback=nullptr, OperationType operationType=OperationType::DATA_LOCAL, std::string apn="")=0`
- virtual `telux::common::Status registerListener (std::weak_ptr< IDataConnectionListener > listener)=0`
- virtual `telux::common::Status deregisterListener (std::weak_ptr< IDataConnectionListener > listener)=0`
- virtual `int getSlotId ()=0`
- virtual `telux::common::Status requestDataCallList (OperationType operationType, DataCallListResponseCb callback)=0`
- virtual `~IDataConnectionManager ()`

#### 4.54.2.10.1 Constructors and Destructors

4.54.2.10.1.1 `virtual telux::data::IDataConnectionManager::~IDataConnectionManager ( ) [virtual]`

Destructor for `IDataConnectionManager`

#### 4.54.2.10.2 Member Function Documentation

4.54.2.10.2.1 `virtual telux::common::ServiceStatus telux::data::IDataConnectionManager::getService↔ Status ( ) [pure virtual]`

Returns current initialization status of data connection manager.

#### Returns

- `SERVICE_AVAILABLE` If data connection manager is ready for service.
- `SERVICE_UNAVAILABLE` If data connection manager is temporarily unavailable.
- `SERVICE_FAILED` If data connection manager encountered an irrecoverable failure.

#### 4.54.2.10.2.2 `virtual bool telux::data::IDataConnectionManager::isSubsystemReady ( ) [pure virtual]`

Checks if the data subsystem is ready.

##### Returns

True if Data Connection Manager is ready for service, otherwise returns false.

##### Deprecated

Use getServiceStatus API.

#### 4.54.2.10.2.3 `virtual std::future<bool> telux::data::IDataConnectionManager::onSubsystemReady ( ) [pure virtual]`

Wait for data subsystem to be ready.

##### Returns

A future that caller can wait on to be notified when card manager is ready.

##### Deprecated

Use InitResponseCb callback in factory API getDataConnectionManager.

#### 4.54.2.10.2.4 `virtual telux::common::Status telux::data::IDataConnectionManager::setDefaultProfile ( OperationType operationType, uint8_t profileId, telux::common::ResponseCallback callback = nullptr ) [pure virtual]`

Set a profile as default which results in following: Traffic from devices tethered to MDM via default network interfaces such as eth0, ecm0, and mhi0 will be directed to rmnet\_data that was brought up with default profile. Traffic initiated within MDM or EAP that is destined for WAN network and is not bound to a WAN interface will be routed by default to WAN network corresponding to the default profile ID

On platforms with Access control enabled, Caller needs to have TELUX\_DATA\_SETTING permission to invoke this API successfully.

##### Parameters

in	<i>operationType</i>	<a href="#">telux::data::OperationType</a>
in	<i>profileId</i>	Profile identifier to be set as default
in	<i>callback</i>	optional callback to get the response setDefaultProfile

##### Returns

Immediate status of setDefaultProfile i.e. success or suitable status.

**4.54.2.10.2.5** `virtual telux::common::Status telux::data::IDataConnectionManager::getDefaultProfile ( OperationType operationType, DefaultProfileIdResponseCb callback ) [pure virtual]`

Get current default profile

#### Parameters

in	<i>operationType</i>	<a href="#">telux::data::OperationType</a>
in	<i>callback</i>	callback to get the response getDefaultProfile

#### Returns

Immediate status of getDefaultProfile i.e. success or suitable status.

**4.54.2.10.2.6** `virtual telux::common::Status telux::data::IDataConnectionManager::setRoamingMode ( bool enable, uint8_t profileId, OperationType operationType, telux::common::ResponseCallback callback = nullptr ) [pure virtual]`

Enable roaming mode for profile id. If disabled, any client attempt to bring up data call on such profile id will be prevented by system when device is in roaming area. System will report NO\_NETWORK\_FOUND error in such scenario. If enabled, clients can bring up data call made on such profile id and slot id successfully even if device is in roaming area. For this API to work, the platform needs to be configured in tel.conf to allow roaming management, by setting data.manage\_roaming\_for\_datacalls=TRUE. Configuration changes will be persistent across multiple boots.

On platforms with Access control enabled, Caller needs to have TELUX\_DATA\_SETTING permission to invoke this API successfully.

#### Parameters

in	<i>enable</i>	enable/disable roaming mode (True: enable, False:disable).
in	<i>profileId</i>	profile id on which roaming mode to be enabled/disabled.
in	<i>operationType</i>	<a href="#">telux::data::OperationType</a>
in	<i>callback</i>	optional. Callback to get response for enableRoamingMode.

#### Returns

Status of enableRoamingMode i.e. success or suitable status code. NO\_NETWORK\_FOUND error is returned if roaming is not enabled on profile id.

**4.54.2.10.2.7** `virtual telux::common::Status telux::data::IDataConnectionManager::requestRoamingMode ( uint8_t profileId, OperationType operationType, requestRoamingModeResponseCb callback ) [pure virtual]`

Request current roaming mode for profile id.

**Parameters**

in	<i>profileId</i>	profile id on which roaming mode is requested.
in	<i>operationType</i>	<a href="#">telux::data::OperationType</a>
in	<i>callback</i>	callback to get response for requestRoamingMode.

**Returns**

Status of requestRoamingMode i.e. success or suitable status code.

**4.54.2.10.2.8** `virtual telux::common::Status telux::data::IDataConnectionManager::startDataCall ( int profileId, IpFamilyType ipFamilyType = IpFamilyType::IPV4V6, DataCallResponseCb callback = nullptr, OperationType operationType = OperationType::DATA_LOCAL, std::string apn = "" ) [pure virtual]`

Starts a data call corresponding to default or specified profile identifier.

This will bring up data call connection based on specified profile identifier, IP family type, and operation type (local/remote). This is an asynchronous API. If [telux::common::Status::SUCCESS](#) is returned, client provided callback will be invoked at later time with error code and DataCall object associated with requested call. Clients might receive additional notification for the final data call status. For details see [telux::data::DataCallResponseCb](#).

On platforms with Access control enabled, Caller needs to have TELUX\_DATA\_CALL\_OPS permission to invoke this API successfully.

**Note**

if application starts data call on IPV4V6 then it's expected to stop the data call on same ip family type (i.e IPV4V6).

**Parameters**

in	<i>profileId</i>	Profile identifier corresponding to which data call bring up will be done. Use <a href="#">IDataProfileManager::requestProfileList</a> to get list of available profiles.
in	<i>ipFamilyType</i>	Identifies IP family type
out	<i>callback</i>	Optional callback to get the response of start data call.
in	<i>operationType</i>	Optional <a href="#">telux::data::OperationType</a>
in	<i>apn</i>	Deprecated and currently unused

**Returns**

Immediate status of [startDataCall\(\)](#) request sent i.e. success or suitable status code.

**4.54.2.10.2.9** `virtual telux::common::Status telux::data::IDataConnectionManager::stopDataCall ( int profileId, IpFamilyType ipFamilyType = IpFamilyType::IPV4V6, DataCallResponseCb callback = nullptr, OperationType operationType = OperationType::DATA_LOCAL, std::string apn = "" ) [pure virtual]`

Tear down data call connection based on specified profile identifier, IP family type, and operation type (local/remote). This is an asynchronous API. If `telux::common::Status::SUCCESS` is returned, client provided callback will be invoked at later time with error code and DataCall object associated with requested call. Clients might receive additional notification for the final data call status. For details see `telux::data::DataCallResponseCb`.

This will tear down specific data call connection based on profile identifier.

On platforms with Access control enabled, Caller needs to have TELUX\_DATA\_CALL\_OPS permission to invoke this API successfully.

#### Note

If application starts data call on IPV4V6 then it's expected to stop the data call on same ip family type (i.e IPV4V6). Client can only stop data call it started.

#### Parameters

in	<i>profileId</i>	Profile identifier corresponding to which data call tear down will be done. Use data profile manager to get the list of available profiles.
in	<i>ipFamilyType</i>	Identifies IP family type
out	<i>callback</i>	Optional callback to get the response of stop data call
in	<i>operationType</i>	Optional <code>telux::data::OperationType</code>
in	<i>apn</i>	Deprecated and currently unused

#### Returns

Immediate status of `stopDataCall()` request sent i.e. success or suitable status code. The client receives asynchronous notifications indicating the data call tear-down.

**4.54.2.10.2.10** `virtual telux::common::Status telux::data::IDataConnectionManager::registerListener ( std::weak_ptr< IDataConnectionListener > listener ) [pure virtual]`

Register a listener for specific events in the Connection Manager like establishment of new data call, data call info change and call failure.

#### Parameters

in	<i>listener</i>	pointer of <code>IDataConnectionListener</code> object that processes the notification
----	-----------------	--

#### Returns

Status of registerListener success or suitable status code



**4.54.2.10.2.11** virtual `telux::common::Status telux::data::IDataConnectionManager::deregisterListener ( std::weak_ptr< IDataConnectionListener > listener ) [pure virtual]`

Removes a previously added listener.

#### Parameters

in	<i>listener</i>	pointer of <a href="#">IDataConnectionListener</a> object that needs to be removed
----	-----------------	--

#### Returns

Status of `deregisterListener` success or suitable status code

**4.54.2.10.2.12** virtual `int telux::data::IDataConnectionManager::getSlotId ( ) [pure virtual]`

Get associated slot id for the Data Connection Manager.

#### Returns

SlotId

**4.54.2.10.2.13** virtual `telux::common::Status telux::data::IDataConnectionManager::requestData← CallList ( OperationType operationType, DataCallListResponseCb callback ) [pure virtual]`

Request list of data calls available in the system

#### Parameters

out	<i>operationType</i>	<a href="#">telux::data::OperationType</a>
out	<i>callback</i>	Callback with list of supported data calls

### 4.54.2.11 class `telux::data::IDataCall`

Represents single established data call on the device.

#### Public member functions

- virtual const std::string & [getInterfaceName](#) ()=0
- virtual [DataCallEndReason](#) [getDataCallEndReason](#) ()=0
- virtual [DataCallStatus](#) [getDataCallStatus](#) ()=0
- virtual [IpFamilyInfo](#) [getIpv4Info](#) ()=0
- virtual [IpFamilyInfo](#) [getIpv6Info](#) ()=0
- virtual [TechPreference](#) [getTechPreference](#) ()=0
- virtual std::list< [IpAddrInfo](#) > [getIpAddressInfo](#) ()=0

- virtual [IpFamilyType](#) `getIpFamilyType ()=0`
- virtual `int` `getProfileId ()=0`
- virtual `SlotId` `getSlotId ()=0`
- virtual `OperationType` `getOperationType ()=0`
- virtual `telux::common::Status` `requestTrafficFlowTemplate (IpFamilyType ipFamilyType, TrafficFlowTemplateCb callback)=0`
- virtual `telux::common::Status` `requestDataCallStatistics (StatisticsResponseCb callback=nullptr)=0`
- virtual `telux::common::Status` `resetDataCallStatistics (telux::common::ResponseCallback callback=nullptr)=0`
- virtual `telux::common::Status` `requestDataCallBitRate (requestDataCallBitRateResponseCb callback)=0`
- virtual `~IDataCall ()`
- virtual `DataBearerTechnology` `getCurrentBearerTech ()=0`

#### 4.54.2.11.1 Constructors and Destructors

4.54.2.11.1.1 virtual `telux::data::IDataCall::~~IDataCall ( ) [virtual]`

Destructor for [IDataCall](#)

#### 4.54.2.11.2 Member Function Documentation

4.54.2.11.2.1 virtual `const std::string&` `telux::data::IDataCall::getInterfaceName ( ) [pure virtual]`

Get interface name associated with the data call.

##### Returns

Interface Name.

4.54.2.11.2.2 virtual `DataCallEndReason` `telux::data::IDataCall::getDataCallEndReason ( ) [pure virtual]`

Get failure reason for the data call.

##### Returns

[DataCallEndReason](#)

**4.54.2.11.2.3 virtual DataCallStatus telux::data::IDataCall::getDataCallStatus ( ) [pure virtual]**

Get data call status like connected, disconnected and IP address changes.

**Returns**

[DataCallStatus](#).

**4.54.2.11.2.4 virtual IpFamilyInfo telux::data::IDataCall::getIpv4Info ( ) [pure virtual]**

Get IPv4 Family info like connected, disconnected and IP address changes.

**Returns**

[IpFamilyInfo](#).

**4.54.2.11.2.5 virtual IpFamilyInfo telux::data::IDataCall::getIpv6Info ( ) [pure virtual]**

Get IPv6 Family info like connected, disconnected and IP address changes.

**Returns**

[IpFamilyInfo](#).

**4.54.2.11.2.6 virtual TechPreference telux::data::IDataCall::getTechPreference ( ) [pure virtual]**

Get the technology on which the call was brought up.

**Returns**

[TechPreference](#).

**4.54.2.11.2.7 virtual std::list<IpAddrInfo> telux::data::IDataCall::getIpAddressInfo ( ) [pure virtual]**

Get list of IP address information.

**Returns**

List of IP address details.

**4.54.2.11.2.8 virtual IpFamilyType telux::data::IDataCall::getIpFamilyType ( ) [pure virtual]**

Get IP Family Type i.e. IPv4, IPv6 or Both

**Returns**

[IpFamilyType](#).

**4.54.2.11.2.9 virtual int telux::data::IDataCall::getProfileId ( ) [pure virtual]**

Get Profile Id

**Returns**

Profile Identifier.

**4.54.2.11.2.10 virtual SlotId telux::data::IDataCall::getSlotId ( ) [pure virtual]**

Get Slot Id

**Returns**

Subscription Slot Identifier.

**4.54.2.11.2.11 virtual OperationType telux::data::IDataCall::getOperationType ( ) [pure virtual]**

Get data operation used for the DataCall.

**Returns**

[OperationType](#)

**4.54.2.11.2.12 virtual telux::common::Status telux::data::IDataCall::requestTrafficFlowTemplate ( IpFamilyType ipFamilyType, TrafficFlowTemplateCb callback ) [pure virtual]**

Get the current installed QOS Traffic flow template information.

**Parameters**

in	<i>ipFamilyType</i>	- IP Family type <a href="#">IpFamilyType</a> . TFT's are installed per IP Family.
in	<i>callback</i>	- callback function to get the result of API.

**Returns**

Status of requestTrafficFlowTemplate i.e. success or suitable status code.

**4.54.2.11.2.13 virtual telux::common::Status telux::data::IDataCall::requestDataCallStatistics ( StatisticsResponseCb callback = nullptr ) [pure virtual]**

Request the data transfer statistics for data call corresponding to specified profile identifier.

**Parameters**

in	<i>callback</i>	Optional callback to get the response of request Data Call Statistics
----	-----------------	---

**Returns**

Status of getDataCallStatistics i.e. success or suitable status code.

**4.54.2.11.2.14** `virtual telux::common::Status telux::data::IDataCall::resetDataCallStatistics ( telux::common::ResponseCallback callback = nullptr ) [pure virtual]`

Reset data transfer statistics for data call corresponding to specified profile identifier.

On platforms with Access control enabled, Caller needs to have TELUX\_DATA\_CALL\_PROPS permission to invoke this API successfully.

**Parameters**

in	<i>callback</i>	optional callback to get the response of reset Data call statistics
----	-----------------	---

**Returns**

Status of resetDataCallStatistics i.e. success or suitable status code.

**4.54.2.11.2.15** `virtual telux::common::Status telux::data::IDataCall::requestDataCallBitRate ( requestDataCallBitRateResponseCb callback ) [pure virtual]`

Request data call bit rate in (bits/sec).

**Parameters**

out	<i>callback</i>	callback to be called with bit rate results <a href="#">requestDataCallBitRateResponseCb</a>
-----	-----------------	---

**Returns**

Status of requestDataCallBitRate success or suitable status code

**4.54.2.11.2.16** `virtual DataBearerTechnology telux::data::IDataCall::getCurrentBearerTech ( ) [pure virtual]`

Get the bearer technology on which earlier data call was brought up like LTE, WCDMA and etc. This is synchronous API called by client to get bearer technology corresponding to data call.

**Returns**

[DataBearerTechnology](#)

**Deprecated**

, use [telux::data::IServingSystemManager::requestServiceStatus](#) instead

#### 4.54.2.12 class telux::data::IDataConnectionListener

Interface for Data connection listener object. Client needs to implement this interface to get access to data services notifications like onNewDataCall, onDataCallStatusChanged and onDataCallFailure.

The methods in listener can be invoked from multiple different threads. The implementation should be thread safe.

The notification delivery mechanism uses the same thread to deliver all the queued notifications to ensure they are delivered in order. Considering this, the thread on which the notifications are delivered should not be blocked for longer operations since this would result in delay in delivery of further notifications that are in the queue waiting to be dispatched.

##### Public member functions

- virtual void [onDataCallInfoChanged](#) (const std::shared\_ptr< [IDataCall](#) > &dataCall)
- virtual void [onHwAccelerationChanged](#) (const [ServiceState](#) state)
- virtual void [onTrafficFlowTemplateChange](#) (const std::shared\_ptr< [IDataCall](#) > &dataCall, const std::vector< std::shared\_ptr< [TftChangeInfo](#) >> &tft)
- virtual void [onWwanConnectivityConfigChange](#) (SlotId slotId, bool isConnectivityAllowed)
- virtual [~IDataConnectionListener](#) ()

##### 4.54.2.12.1 Constructors and Destructors

4.54.2.12.1.1 virtual telux::data::IDataConnectionListener::~~IDataConnectionListener ( ) [virtual]

Destructor for [IDataConnectionListener](#)

##### 4.54.2.12.2 Member Function Documentation

4.54.2.12.2.1 virtual void telux::data::IDataConnectionListener::onDataCallInfoChanged ( const std::shared\_ptr< [IDataCall](#) > & *dataCall* ) [virtual]

This function is called when there is a change in the data call.

##### Parameters

in	<i>dataCall</i>	Pointer to <a href="#">IDataCall</a>
----	-----------------	--------------------------------------

4.54.2.12.2.2 virtual void telux::data::IDataConnectionListener::onHwAccelerationChanged ( const [ServiceState](#) *state* ) [virtual]

This function is called when a change occur in hardware acceleration service. If reported state is [ServiceState::INACTIVE](#): All existing data calls will take software acceleration path. If reported state is [ServiceState::ACTIVE](#): All new data calls that are started after this API invocation will be H/w accelerated. Data calls that existed before this API was invoked will continue without h/w acceleration. Client could stop and re-start pre-existing data calls in order to use H/w acceleration.

**Parameters**

in	<i>state</i>	New state of hardware Acceleration service (Active/Inactive)
----	--------------	--

**Note**

This is global state

**4.54.2.12.2.3** `virtual void telux::data::IDataConnectionListener::onTrafficFlowTemplateChange ( const std::shared_ptr< IDataCall > & dataCall, const std::vector< std::shared_ptr< TftChangeInfo >> & tft ) [virtual]`

This function is called when the TFT's parameters are changed for a packet data session.

**Parameters**

in	<i>dataCall</i>	Pointer to <a href="#">IDataCall</a>
in	<i>tft</i>	vector of <a href="#">TftChangeInfo</a> <a href="#">TftChangeInfo</a>

**4.54.2.12.2.4** `virtual void telux::data::IDataConnectionListener::onWwanConnectivityConfigChange ( SlotId slotId, bool isConnectivityAllowed ) [virtual]`

This function is called when WWAN backhaul connectivity config changes.

**Parameters**

in	<i>slotId</i>	- Slot Id for which connectivity has changed.
in	<i>isConnectivityAllowed</i>	- Connectivity status allowed/disallowed.

**4.54.2.13 struct telux::data::DataRestrictMode**

Defines the supported powersave filtering mode and autoexit for the packet data session.

[DataRestrictModeType](#)

**Data fields**

Type	Field	Description
<a href="#">DataRestrictModeType</a>	filterMode	Disable or enable data filter mode. When disabled all the data packets will be forwarded from modem to the apps. When enabled only the data matching the filters will be forwarded from modem to the apps.
<a href="#">DataRestrictModeType</a>	filterAutoExit	Disable or enable autoexit feature. When enabled, once an incoming packet matching the filter is received, filter mode will be disabled automatically and any packet will be allowed to be forwarded from modem to apps.

#### 4.54.2.14 struct telux::data::PortInfo

Used to define the Port number and range (number of ports following port value) Ex- for ports ranging from 1000-3000 port = 1000 and range= 2000

for single port 5000 port = 5000 and range= 0

##### Data fields

Type	Field	Description
uint16_t	port	Port.
uint16_t	range	Range.

#### 4.54.2.15 struct telux::data::ProfileParams

Profile Parameters used for profile creation, query and modify

##### Data fields

Type	Field	Description
string	profileName	Profile Name
string	apn	APN name
string	userName	APN user name (if any)
string	password	APN password (if any)
<a href="#">TechPreference</a>	techPref	Technology preference, default is <a href="#">TechPreference::UNKNOWN</a>
<a href="#">AuthProtocolType</a>	authType	Authentication protocol type, default is <a href="#">AuthProtocolType::AUTH_NONE</a>
<a href="#">IpFamilyType</a>	ipFamilyType	Preferred IP family for the call, default is <a href="#">IpFamilyType::UNKNOWN</a>
<a href="#">ApnTypes</a>	apnTypes	APN Types <a href="#">ApnMaskType</a>

#### 4.54.2.16 struct telux::data::DataCallStats

Data transfer statistics structure.

##### Data fields

Type	Field	Description
uint64_t	packetsTx	Number of packets transmitted
uint64_t	packetsRx	Number of packets received
uint64_t	bytesTx	Number of bytes transmitted
uint64_t	bytesRx	Number of bytes received
uint64_t	packets↔ DroppedTx	Number of transmit packets dropped
uint64_t	packets↔ DroppedRx	Number of receive packets dropped



**4.54.2.17 struct telux::data::IpAddrInfo**

IP address information structure

**Data fields**

Type	Field	Description
string	ifAddress	Interface IP address.
unsigned int	ifMask	Subnet mask.
string	gwAddress	Gateway IP address.
unsigned int	gwMask	Subnet mask.
string	primaryDns↔ Address	Primary DNS address.
string	secondary↔ DnsAddress	Secondary DNS address.

**4.54.2.18 struct telux::data::DataCallEndReason**

Structure represents data call failure reason type and code.

**Data fields**

Type	Field	Description
<a href="#">EndReason↔ Type</a>	type	Data call terminated due to reason type, default is CE_UNKNOWN
<a href="#">union Data↔ CallEndReason</a>	__unnamed_↔ _	

**4.54.2.19 struct telux::data::BackhaulInfo**

Encapsulate backhaul configuration parameters

**Data fields**

Type	Field	Description
<a href="#">BackhaulType</a>	backhaul	
SlotId	slotId	Backhaul type to apply configuration on.
int	profileId	Slot Id which has sim that contains profile id Needed only for WWAN backhaul

**4.54.2.20 struct telux::data::VlanConfig**

Structure for vlan configuration

**Data fields**

Type	Field	Description
<a href="#">InterfaceType</a>	iface	PHY interfaces (i.e. ETH, ECM and RNDIS)
int16_t	vlanId	Vlan identifier (i.e 1-4094)

Type	Field	Description
bool	isAccelerated	is acceleration allowed
uint8_t	priority	Vlan priority - A 3-bit field which refers to the IEEE 802.1p class of service to traffic priority level. Don't care = 0

#### 4.54.2.21 struct telux::data::FlowDataRate

QOS Flow data min max rate bits per seconds

##### Data fields

Type	Field	Description
uint64_t	maxRate	QOS Flow maximum data rate
uint64_t	minRate	QOS Flow minimum data rate

#### 4.54.2.22 struct telux::data::QosIPFlowInfo

QOS Flow IP info

##### Data fields

Type	Field	Description
<a href="#">QosIPFlowMask</a>	mask	Valid parameters of <a href="#">QosIPFlowInfo</a> <a href="#">QosIPFlowMaskType</a>
<a href="#">IpTrafficClassType</a>	tfClass	IP Traffic class type <a href="#">IpTrafficClassType</a>
<a href="#">FlowDataRate</a>	dataRate	Flow data rate <a href="#">FlowDataRate</a>

#### 4.54.2.23 class telux::data::DataFactory

[DataFactory](#) is the central factory to create all data classes.

##### Public member functions

- virtual std::shared\_ptr< [IDataConnectionManager](#) > [getDataConnectionManager](#) (SlotId slotId=DEFAULT\_SLOT\_ID, [telux::common::InitResponseCb](#) clientCallback=nullptr)=0
- virtual std::shared\_ptr< [IDataProfileManager](#) > [getDataProfileManager](#) (SlotId slotId=DEFAULT\_SLOT\_ID, [telux::common::InitResponseCb](#) clientCallback=nullptr)=0
- virtual std::shared\_ptr< [IServingSystemManager](#) > [getServingSystemManager](#) (SlotId slotId=DEFAULT\_SLOT\_ID, [telux::common::InitResponseCb](#) clientCallback=nullptr)=0
- virtual std::shared\_ptr< [IDataFilterManager](#) > [getDataFilterManager](#) (SlotId slotId=DEFAULT\_SLOT\_ID, [telux::common::InitResponseCb](#) clientCallback=nullptr)=0
- virtual std::shared\_ptr< [telux::data::net::INatManager](#) > [getNatManager](#) ([telux::data::OperationType](#) oprType, [telux::common::InitResponseCb](#) clientCallback=nullptr)=0
- virtual std::shared\_ptr< [telux::data::net::IFirewallManager](#) > [getFirewallManager](#) ([telux::data::OperationType](#) oprType, [telux::common::InitResponseCb](#) clientCallback=nullptr)=0

- virtual std::shared\_ptr< [telux::data::net::IFirewallEntry](#) > [getNewFirewallEntry](#) ([IpProtocol](#) proto, [Direction](#) direction, [IpFamilyType](#) ipFamilyType)=0
- virtual std::shared\_ptr< [IpFilter](#) > [getNewIpFilter](#) ([IpProtocol](#) proto)=0
- virtual std::shared\_ptr< [telux::data::net::IVlanManager](#) > [getVlanManager](#) ([telux::data::OperationType](#) oprType, [telux::common::InitResponseCb](#) clientCallback=nullptr)=0
- virtual std::shared\_ptr< [telux::data::net::ISocksManager](#) > [getSocksManager](#) ([telux::data::OperationType](#) oprType, [telux::common::InitResponseCb](#) clientCallback=nullptr)=0
- virtual std::shared\_ptr< [telux::data::net::IBridgeManager](#) > [getBridgeManager](#) ([telux::common::InitResponseCb](#) clientCallback=nullptr)=0
- virtual std::shared\_ptr< [telux::data::net::IL2tpManager](#) > [getL2tpManager](#) ([telux::common::InitResponseCb](#) clientCallback=nullptr)=0
- virtual std::shared\_ptr< [telux::data::IDataSettingsManager](#) > [getDataSettingsManager](#) ([telux::data::OperationType](#) oprType, [telux::common::InitResponseCb](#) clientCallback=nullptr)=0
- virtual std::shared\_ptr< [IDataLinkManager](#) > [getDataLinkManager](#) ([telux::common::InitResponseCb](#) clientCallback=nullptr)=0
- virtual std::shared\_ptr< [IClientManager](#) > [getClientManager](#) ([telux::common::InitResponseCb](#) clientCallback=nullptr)=0

### Static Public Member Functions

- static [DataFactory](#) & [getInstance](#) ()

### 4.54.2.23.1 Member Function Documentation

#### 4.54.2.23.1.1 static [DataFactory](#)& [telux::data::DataFactory::getInstance](#) ( ) [[static](#)]

Get Data Factory instance.

#### 4.54.2.23.1.2 virtual std::shared\_ptr<[IDataConnectionManager](#)> [telux::data::DataFactory::get](#)↔ [DataConnectionManager](#) ( [SlotId](#) *slotId* = [DEFAULT\\_SLOT\\_ID](#), [telux::common::Init](#)↔ [ResponseCb](#) *clientCallback* = [nullptr](#) ) [[pure virtual](#)]

Get Data Connection Manager

### Parameters

in	<i>slotId</i>	Unique identifier for the SIM slot
in	<i>clientCallback</i>	Optional callback to get the initialization status of <a href="#">IDataConnectionManager</a> <a href="#">telux::common::InitResponseCb</a>

### Returns

instance of [IDataConnectionManager](#)

**4.54.2.23.1.3** `virtual std::shared_ptr<IDataProfileManager> telux::data::DataFactory::getData←  
ProfileManager ( SlotId slotId = DEFAULT_SLOT_ID, telux::common::InitResponseCb  
clientCallback = nullptr ) [pure virtual]`

Get Data Profile Manager

#### Parameters

in	<i>slotId</i>	Unique identifier for the SIM slot
in	<i>clientCallback</i>	Optional callback to get the initialization status of DataProfileManager <a href="#">telux::common::InitResponseCb</a>

#### Returns

instance of [IDataProfileManager](#)

**4.54.2.23.1.4** `virtual std::shared_ptr<IServingSystemManager> telux::data::DataFactory::getServing←  
SystemManager ( SlotId slotId = DEFAULT_SLOT_ID, telux::common::InitResponseCb  
clientCallback = nullptr ) [pure virtual]`

Get Serving System Manager

#### Parameters

in	<i>slotId</i>	Unique identifier for the SIM slot
in	<i>clientCallback</i>	Optional callback to get the initialization status of ServingSystemManager <a href="#">telux::common::InitResponseCb</a>

#### Returns

instance of [IServingSystemManager](#)

**4.54.2.23.1.5** `virtual std::shared_ptr<IDataFilterManager> telux::data::DataFactory::getData←  
FilterManager ( SlotId slotId = DEFAULT_SLOT_ID, telux::common::InitResponseCb  
clientCallback = nullptr ) [pure virtual]`

Get Data Filter Manager instance

#### Parameters

in	<i>slotId</i>	Unique identifier for the SIM slot
in	<i>clientCallback</i>	Optional callback to get the initialization status of Serving System Manager <a href="#">telux::common::InitResponseCb</a>

#### Returns

instance of [IDataFilterManager](#).

**4.54.2.23.1.6** `virtual std::shared_ptr<telux::data::net::INatManager> telux::data::DataFactory::getNatManager ( telux::data::OperationType oprType, telux::common::InitResponseCb clientCallback = nullptr ) [pure virtual]`

Get Network Address Translation(NAT) Manager

#### Parameters

in	<i>oprType</i>	Required operation type <a href="#">telux::data::OperationType</a>
in	<i>clientCallback</i>	Optional callback to get the initialization status of NAT manager <a href="#">telux::common::InitResponseCb</a>

#### Returns

instance of INatManager or nullptr if NAT management is not supported

**4.54.2.23.1.7** `virtual std::shared_ptr<telux::data::net::IFirewallManager> telux::data::DataFactory::getFirewallManager ( telux::data::OperationType oprType, telux::common::InitResponseCb clientCallback = nullptr ) [pure virtual]`

Get Firewall Manager

#### Parameters

in	<i>oprType</i>	Required operation type <a href="#">telux::data::OperationType</a>
in	<i>clientCallback</i>	Optional callback to get the initialization status of Firewall manager <a href="#">telux::common::InitResponseCb</a>

#### Returns

instance of IFirewallManager or nullptr if Firewall management is not supported

**4.54.2.23.1.8** `virtual std::shared_ptr<telux::data::net::IFirewallEntry> telux::data::DataFactory::getNewFirewallEntry ( IpProtocol proto, Direction direction, IpFamilyType ipFamilyType ) [pure virtual]`

Get Firewall entry based on IP protocol and set respective filter (i.e. TCP or UDP)

#### Parameters

in	<i>proto</i>	<a href="#">telux::data::IpProtocol</a>
in	<i>direction</i>	<a href="#">telux::data::Direction</a>
in	<i>ipFamilyType</i>	Identifies IP family type <a href="#">telux::data::IpFamilyType</a>

#### Returns

instance of IFirewallEntry

#### 4.54.2.23.1.9 `virtual std::shared_ptr<IIPFilter> telux::data::DataFactory::getNewIIPFilter ( IpProtocol proto ) [pure virtual]`

Get [IIPFilter](#) instance based on IP Protocol, This can be used in Firewall Manager and Data Filter Manager

##### Parameters

in	<i>proto</i>	<a href="#">telux::data::IpProtocol</a> Some sample protocol values are ICMP = 1 # Internet Control Message Protocol - RFC 792 IGMP = 2 # Internet Group Management Protocol - RFC 1112 TCP = 6 # Transmission Control Protocol - RFC 793 UDP = 17 # User Datagram Protocol - RFC 768 ESP = 50 # Encapsulating Security Payload - RFC 4303
----	--------------	--

##### Returns

instance of [IIPFilter](#) based on IpProtocol filter (i.e TCP, UDP)

#### 4.54.2.23.1.10 `virtual std::shared_ptr<telux::data::net::IVlanManager> telux::data::DataFactory::getVlanManager ( telux::data::OperationType oprType, telux::common::InitResponseCb clientCallback = nullptr ) [pure virtual]`

Get VLAN Manager

##### Parameters

in	<i>oprType</i>	Required operation type <a href="#">telux::data::OperationType</a>
in	<i>clientCallback</i>	Optional callback to get the initialization status of Vlan manager <a href="#">telux::common::InitResponseCb</a>

##### Returns

instance of [IVlanManager](#)

#### 4.54.2.23.1.11 `virtual std::shared_ptr<telux::data::net::ISocksManager> telux::data::DataFactory::getSocksManager ( telux::data::OperationType oprType, telux::common::InitResponseCb clientCallback = nullptr ) [pure virtual]`

Get Socks Manager

##### Parameters

in	<i>oprType</i>	Required operation type <a href="#">telux::data::OperationType</a>
in	<i>clientCallback</i>	Optional callback to get the initialization status of Socks manager <a href="#">telux::common::InitResponseCb</a>

##### Returns

instance of [ISocksManager](#) or nullptr if Socks management is not supported

**4.54.2.23.1.12** `virtual std::shared_ptr<telux::data::net::IBridgeManager> telux::data::DataFactory::getBridgeManager ( telux::common::InitResponseCb clientCallback = nullptr ) [pure virtual]`

Get Software Bridge Manager

#### Parameters

in	<i>clientCallback</i>	Optional callback to get the initialization status of Bridge manager <a href="#">telux::common::InitResponseCb</a>
----	-----------------------	--

#### Returns

instance of [IBridgeManager](#)

**4.54.2.23.1.13** `virtual std::shared_ptr<telux::data::net::IL2tpManager> telux::data::DataFactory::getL2tpManager ( telux::common::InitResponseCb clientCallback = nullptr ) [pure virtual]`

Get L2TP Manager

#### Parameters

in	<i>clientCallback</i>	Optional callback to get the initialization status of L2TP manager <a href="#">telux::common::InitResponseCb</a>
----	-----------------------	--

#### Returns

instance of [IL2tpManager](#)

**4.54.2.23.1.14** `virtual std::shared_ptr<telux::data::IDataSettingsManager> telux::data::DataFactory::getDataSettingsManager ( telux::data::OperationType oprType, telux::common::InitResponseCb clientCallback = nullptr ) [pure virtual]`

Get Data Settings Manager

#### Parameters

in	<i>oprType</i>	Required operation type <a href="#">telux::data::OperationType</a>
in	<i>clientCallback</i>	Optional callback to get the initialization status of Data Settings manager <a href="#">telux::common::InitResponseCb</a>

#### Returns

instance of [IDataSettingsManager](#)

**4.54.2.23.1.15** `virtual std::shared_ptr<IDataLinkManager> telux::data::DataFactory::getDataLinkManager ( telux::common::InitResponseCb clientCallback = nullptr ) [pure virtual]`

Get Data Link Manager For hypervisor-based platforms, [IDataLinkManager](#) is supported only in the primary/host VM.

#### Parameters

<i>in</i>	<i>clientCallback</i>	Optional callback to get the initialization status of <a href="#">IDataLinkManager</a> <code>telux::common::InitResponseCb</code>
-----------	-----------------------	---

#### Returns

instance of [IDataLinkManager](#)

**4.54.2.23.1.16** `virtual std::shared_ptr<IClientManager> telux::data::DataFactory::getClientManager ( telux::common::InitResponseCb clientCallback = nullptr ) [pure virtual]`

Get Client Manager

#### Parameters

<i>in</i>	<i>clientCallback</i>	Optional callback to get the initialization status of <a href="#">ClientManager</a> <code>telux::common::InitResponseCb</code> .
-----------	-----------------------	--

#### Returns

instance of [IClientManager](#)

### 4.54.2.24 class telux::data::IDataFilterListener

Listener class for listening to filtering mode notifications, like Data filtering mode change. Client need to implement these methods. The methods in listener can be invoked from multiple threads. So the client needs to make sure that the implementation is thread-safe.

#### Public member functions

- virtual void [onDataRestrictModeChange](#) ([DataRestrictMode](#) mode)
- virtual [~IDataFilterListener](#) ()

#### 4.54.2.24.1 Constructors and Destructors

**4.54.2.24.1.1** `virtual telux::data::IDataFilterListener::~~IDataFilterListener ( ) [virtual]`

Destructor of [IDataFilterListener](#)



#### 4.54.2.24.2 Member Function Documentation

##### 4.54.2.24.2.1 virtual void telux::data::IDataFilterListener::onDataRestrictModeChange ( DataRestrictMode mode ) [virtual]

This function is called when the data filtering mode is changed for the packet data session.

#### Parameters

in	<i>mode</i>	- state the current data filter mode
----	-------------	--------------------------------------

#### Note

Currently this API is unsupported.

#### 4.54.2.25 class telux::data::IDataFilterManager

[IDataFilterManager](#) class provides interface to enable/disable the data restrict filters and register for data restrict filter. The filtering can be done at any time. One such use case is to do it when we want the AP to suspend so that we are not waking up the AP due to spurious incoming messages. Also to make sure the DataRestrict mode is enabled.

In contrary to when DataRestrict mode is disabled, modem will forward all the incoming data packets to AP and might wake up AP unnecessarily.

#### Public member functions

- virtual [telux::common::ServiceStatus](#) getServiceStatus ()=0
- virtual [telux::common::Status](#) registerListener (std::weak\_ptr< [IDataFilterListener](#) > listener)=0
- virtual [telux::common::Status](#) deregisterListener (std::weak\_ptr< [IDataFilterListener](#) > listener)=0
- virtual [telux::common::Status](#) setDataRestrictMode ([DataRestrictMode](#) mode, [telux::common::ResponseCallback](#) callback=nullptr)=0
- virtual [telux::common::Status](#) requestDataRestrictMode ([DataRestrictModeCb](#) callback)=0
- virtual [telux::common::Status](#) addDataRestrictFilter (std::shared\_ptr< [IipFilter](#) > &filter, [telux::common::ResponseCallback](#) callback=nullptr)=0
- virtual [telux::common::Status](#) removeAllDataRestrictFilters ([telux::common::ResponseCallback](#) callback=nullptr)=0
- virtual [SlotId](#) getSlotId ()=0
- virtual bool isReady ()=0
- virtual std::future< bool > onReady ()=0
- virtual [telux::common::Status](#) setDataRestrictMode ([DataRestrictMode](#) mode, [telux::common::ResponseCallback](#) callback, int profileId, [IpFamilyType](#) ipFamilyType=[IpFamilyType::UNKNOWN](#))=0
- virtual [telux::common::Status](#) requestDataRestrictMode (std::string ifaceName, [DataRestrictModeCb](#) callback)=0

- virtual `telux::common::Status addDataRestrictFilter` (`std::shared_ptr< IipFilter > &filter`, `telux::common::ResponseCallback callback`, `int profileId`, `IpFamilyType ipFamilyType=IpFamilyType::UNKNOWN`)=0
- virtual `telux::common::Status removeAllDataRestrictFilters` (`telux::common::ResponseCallback callback`, `int profileId`, `IpFamilyType ipFamilyType=IpFamilyType::UNKNOWN`)=0
- virtual `~IDataFilterManager` ()

#### 4.54.2.25.1 Constructors and Destructors

4.54.2.25.1.1 virtual `telux::data::IDataFilterManager::~~IDataFilterManager` ( ) [`virtual`]

Destructor of `IDataFilterManager`

#### 4.54.2.25.2 Member Function Documentation

4.54.2.25.2.1 virtual `telux::common::ServiceStatus telux::data::IDataFilterManager::getServiceStatus` ( ) [`pure virtual`]

Checks the status of data filter manager and returns the result.

##### Returns

the status of sensor sub-system status `telux::common::ServiceStatus`

4.54.2.25.2.2 virtual `telux::common::Status telux::data::IDataFilterManager::registerListener` (`std::weak_ptr< IDataFilterListener > listener`) [`pure virtual`]

Register a listener for powersave filtering mode notifications.

##### Parameters

in	<i>listener</i>	- Pointer of <code>IDataFilterListener</code> object that processes the notification
----	-----------------	--

##### Returns

Status of registerListener i.e success or suitable status code.

4.54.2.25.2.3 virtual `telux::common::Status telux::data::IDataFilterManager::deregisterListener` (`std::weak_ptr< IDataFilterListener > listener`) [`pure virtual`]

Remove a previously registered listener.

##### Parameters

in	<i>listener</i>	- Previously registered <code>IDataFilterListener</code> that needs to be removed
----	-----------------	---

**Returns**

Status of deregisterListener, success or suitable status code

**4.54.2.25.2.4 virtual telux::common::Status telux::data::IDataFilterManager::setDataRestrictMode ( DataRestrictMode *mode*, telux::common::ResponseCallback *callback = nullptr* ) [pure virtual]**

Changes the Data Powersave filter mode and auto exit feature.

This API enables or disables the powersave filtering mode for all active data calls. The mode setting will be reset to [DataRestrictMode::DISABLE](#) when all data calls are disconnected.

On platforms with Access control enabled, Caller needs to have TELUX\_DATA\_FILTER\_OPS permission to invoke this API successfully.

**Parameters**

in	<i>mode</i>	- Enable or disable the powersave filtering mode.
in	<i>callback</i>	- Optional callback to get the response for the change in filter mode.

**Returns**

Status of setDataRestrictMode i.e. success or suitable status code.

**4.54.2.25.2.5 virtual telux::common::Status telux::data::IDataFilterManager::requestDataRestrictMode ( DataRestrictModeCb *callback* ) [pure virtual]**

Get the current Data Powersave filter mode

**Parameters**

in	<i>callback</i>	- callback function to get the result of API.
----	-----------------	---

**Returns**

Status of requestDataRestrictMode i.e. success or suitable status code.

**4.54.2.25.2.6 virtual telux::common::Status telux::data::IDataFilterManager::addDataRestrictFilter ( std::shared\_ptr< llpFilter > & *filter*, telux::common::ResponseCallback *callback = nullptr* ) [pure virtual]**

This API adds a filter rule for all active data calls. In case when DataRestrict mode is enabled, modem will filter all the incoming data packet and route them to application processor only if filter rules added via addDataRestrictFilter API matches the criteria, else they are dropped at the modem itself and not forwarded to application processor.

On platforms with Access control enabled, Caller needs to have TELUX\_DATA\_FILTER\_OPS permission to invoke this API successfully.

**Parameters**

in	<i>filter</i>	- Filter rule.
in	<i>callback</i>	- Optional callback to get the response.

**Returns**

Status of addDataRestrictFilter i.e. success or suitable status code.

**4.54.2.25.2.7 virtual telux::common::Status telux::data::IDataFilterManager::removeAllDataRestrictFilters ( telux::common::ResponseCallback *callback* = nullptr ) [pure virtual]**

This API removes all the previously added powersave filter.

On platforms with Access control enabled, Caller needs to have TELUX\_DATA\_FILTER\_OPS permission to invoke this API successfully.

**Parameters**

in	<i>callback</i>	- Optional callback to get the response.
----	-----------------	--

**Returns**

Status of removeAllDataRestrictFilters i.e. success or suitable status code.

**4.54.2.25.2.8 virtual SlotId telux::data::IDataFilterManager::getSlotId ( ) [pure virtual]**

Get associated slot id for the Data Filter Manager.

**Returns**

SlotId

**4.54.2.25.2.9 virtual bool telux::data::IDataFilterManager::isReady ( ) [pure virtual]**

Checks the status of Data Filter Service and if the other APIs are ready for use, and returns the result.

**Returns**

True if the services are ready otherwise false.

**Deprecated**

Use getServiceStatus API.

**4.54.2.25.2.10** `virtual std::future<bool> telux::data::IDataFilterManager::onReady ( ) [pure virtual]`

Wait for Data Filter Service to be ready.

#### Returns

A future that caller can wait on to be notified when Data Filter Service are ready.

#### Deprecated

Use `InitResponseCb` callback in factory API `getDataFilterManager`.

**4.54.2.25.2.11** `virtual telux::common::Status telux::data::IDataFilterManager::setDataRestrictMode ( DataRestrictMode mode, telux::common::ResponseCallback callback, int profileId, IpFamilyType ipFamilyType = IpFamilyType::UNKNOWN ) [pure virtual]`

Changes the Data Powersave filter mode and auto exit feature.

This API enables or disables the powersave filtering mode of the running packet data session. If a data connection is torn down and brought up again, then previous filter mode setting does not persist for that data call session, and requires to be enabled again.

On platforms with Access control enabled, Caller needs to have `TELUX_DATA_FILTER_OPS` permission to invoke this API successfully.

#### Parameters

in	<i>mode</i>	- Enable or disable the powersave filtering mode.
in	<i>callback</i>	- Optional callback to get the response for the change in filter mode.
in	<i>profileId</i>	- Optional Profile ID for data connection. If user does not specify the profile id, then the API applies to all the currently running data connection. If user wants to apply the changes to any specific data connection, then its profile id can be specified as input.
in	<i>ipFamilyType</i>	- Optional IP Family type <a href="#">IpFamilyType</a> . If user does not specify the ip family type, then the API applies to all the currently running data connection. If user wants to apply the changes to any specific data connection, then its ip family type can be specified as input.

#### Returns

Status of `setDataRestrictMode` i.e. success or suitable status code.

#### Deprecated

because NAO IP filters are global (not per profile) filters. Use [setDataRestrictMode\(DataRestrictMode, telux::common::ResponseCallback\)](#)

#### 4.54.2.25.2.12 virtual telux::common::Status telux::data::IDataFilterManager::requestDataRestrictMode ( std::string *ifaceName*, DataRestrictModeCb *callback* ) [pure virtual]

Get the current Data Powersave filter mode

##### Parameters

in	<i>ifaceName</i>	- Interface name for data connection. Note: For global pdn , ifaceName must be empty, as global restrict mode is reported. Per-pdn requests are not supported.
in	<i>callback</i>	- callback function to get the result of API.

##### Returns

Status of requestDataRestrictMode i.e. success or suitable status code.

##### Deprecated

because NAO IP filters are global (not per profile) filters. Use [requestDataRestrictMode\(DataRestrictModeCb\)](#)

#### 4.54.2.25.2.13 virtual telux::common::Status telux::data::IDataFilterManager::addDataRestrictFilter ( std::shared\_ptr< IIPFilter > & *filter*, telux::common::ResponseCallback *callback*, int *profileId*, IpFamilyType *ipFamilyType* = IpFamilyType::UNKNOWN ) [pure virtual]

This API adds a filter rules for a packet data session to achieve power savings. In case when DataRestrict mode is enabled and AP is in suspended state, Modem will filter all the incoming data packet and route them to AP only if filter rules added via addDataRestrictFilter API matches the criteria, else they are queued at Modem itself and not forwarded to AP, until filter mode is disabled.

On platforms with Access control enabled, Caller needs to have TELUX\_DATA\_FILTER\_OPS permission to invoke this API successfully.

##### Parameters

in	<i>filter</i>	- Filter rule.
in	<i>callback</i>	- Optional callback to get the response.
in	<i>profileId</i>	- Optional Profile ID for data connection. If user does not specify the profile id, then the API applies to all the currently running data connection. If user wants to apply the changes to any specific data connection, then its profile id can be specified as input.
in	<i>ipFamilyType</i>	- Optional IP Family type <a href="#">IpFamilyType</a> . If user does not specify the ip family type, then the API applies to all the currently running data connection. If user wants to apply the changes to any specific data connection, then its ip family type can be specified as input.

**Returns**

Status of addDataRestrictFilter i.e. success or suitable status code.

**Deprecated**

because NAO IP filters are global (not per profile) filters. Use [addDataRestrictFilter\(std::shared\\_ptr<IpFilter>&, telux::common::ResponseCallback\)](#)

**4.54.2.25.2.14** `virtual telux::common::Status telux::data::IDataFilterManager::removeAllDataRestrictFilters ( telux::common::ResponseCallback callback, int profileId, IpFamilyType ipFamilyType = IpFamilyType::UNKNOWN ) [pure virtual]`

This API removes all the previous added powersave filter for a packet data session

On platforms with Access control enabled, Caller needs to have TELUX\_DATA\_FILTER\_OPS permission to invoke this API successfully.

**Parameters**

in	<i>callback</i>	- Optional callback to get the response.
in	<i>profileId</i>	- Optional Profile ID for data connection. If user does not specify the profile id, then the API applies to all the currently running data connection. If user wants to apply the changes to any specific data connection, then its profile id can be specified as input.
in	<i>ipFamilyType</i>	- Optional IP Family type <a href="#">IpFamilyType</a> . If user does not specify the ip family type, then the API applies to all the currently running data connection. If user wants to apply the changes to any specific data connection, then its ip family type can be specified as input.

**Returns**

Status of removeAllDataRestrictFilters i.e. success or suitable status code.

**Deprecated**

because NAO IP filters are global (not per profile) filters. Use [removeAllDataRestrictFilters\(telux::common::ResponseCallback\)](#)

**4.54.2.26 struct telux::data::EthCapability**

Provides Ethernet link capability

**Data fields**

Type	Field	Description
<a href="#">EthModes</a>	ethModes	

#### 4.54.2.27 class telux::data::IDataLinkManager

The Data Link Manager class provides APIs related to data communication links, for example, APIs to update the Ethernet link operating mode.

Under certain scenarios, like thermal mitigation, the local ETH module needs to change the link operating mode, e.g., downgrade it from `EthModeType::USXGMII_10G` to `EthModeType::SGMII_1G`. The ETH module requires that the client communicate and coordinate with the remote end of the link (called the peer) to transition to the new mode. The sequence in which the transition is initiated and completed is illustrated below:

1. On bootup, the client needs to set the capability of the peer using [setPeerEthCapability](#). This allows the local ETH module to transition to a mode that is supported by the peer.
2. When a certain condition is met, like a thermal threshold being crossed, the local ETH module notifies clients about its request to transition to a new mode using `onEthModeChangeRequest`.
3. On receiving this request, the client is expected to:
  - Interact with the peer and request transition to the new mode
  - Use an interconnect other than Ethernet (ETH) to convey the new mode information to the peer, since the Ethernet link will be down after the `onEthModeChangeRequest`
  - Indicate to the local ETH module the intent of the peer by calling [setPeerModeChangeRequestStatus](#).
4. Client gets the status of the transaction to change the mode, via `onEthModeChangeTransactionStatus`

If this code is running as part of an ECU (other end of ETH link) which needs to react to new ETH operating mode requests from NAD, then [setLocalEthOperatingMode](#) needs to be called.

For hypervisor-based platforms, [IDataLinkManager](#) is supported only in the primary/host VM.

##### Public member functions

- virtual [telux::common::ServiceStatus getServiceStatus \(\)](#)=0
- virtual [telux::common::Status getEthCapability \(EthCapability &ethCapability\)](#)=0
- virtual [telux::common::Status setPeerEthCapability \(EthCapability ethCapability\)](#)=0
- virtual [telux::common::Status setLocalEthOperatingMode \(EthModeType ethModeType, telux::common::ResponseCallback callback=nullptr\)](#)=0
- virtual [telux::common::Status setPeerModeChangeRequestStatus \(LinkModeChangeStatus status\)](#)=0
- virtual [telux::common::Status registerListener \(std::weak\\_ptr< IDataLinkListener > listener\)](#)=0
- virtual [telux::common::Status deregisterListener \(std::weak\\_ptr< IDataLinkListener > listener\)](#)=0

##### 4.54.2.27.1 Member Function Documentation



#### 4.54.2.27.1.1 **virtual telux::common::ServiceStatus telux::data::IDataLinkManager::getServiceStatus ( ) [pure virtual]**

Checks the status of Data Link manager object and returns the result.

##### Returns

SERVICE\_AVAILABLE - If Data Link manager object is ready for service.  
 SERVICE\_UNAVAILABLE - If Data Link manager object is temporarily unavailable.  
 SERVICE\_FAILED - If Data Link manager object encountered an irrecoverable failure.

#### 4.54.2.27.1.2 **virtual telux::common::Status telux::data::IDataLinkManager::getEthCapability ( EthCapability & ethCapability ) [pure virtual]**

Gets local ethernet link capability and provides the supported ethernet data rates and respective operating mode (MII variant) considered for thermal mitigation.

On platforms with access control enabled, the caller needs to have TELUX\_DATA\_LINK\_INFO permission to successfully invoke this API.

##### Parameters

out	<i>ethCapability</i>	Info with respect to ETH link capability
-----	----------------------	--

##### Returns

Status of getEthCapability, i.e., success or applicable status code

#### 4.54.2.27.1.3 **virtual telux::common::Status telux::data::IDataLinkManager::setPeerEthCapability ( EthCapability ethCapability ) [pure virtual]**

Informs the NAD about the modes supported by the ECU on the other end of the Ethernet link (peer). For instance, when the temperature of the NAD exceeds certain thresholds, the NAD downgrades the mode of the ETH Link to a low mode supported by the other end.

This info is not persistent over device reboot or sub-system restart (SSR) updated via [IDataLinkListener::onServiceStatusChange\(\)](#)

On platforms with access control enabled, the caller needs to have TELUX\_DATA\_LINK\_CONFIG permission to successfully invoke this API.

##### Parameters

in	<i>ethCapability</i>	Bitmask containing EthModeType bits
----	----------------------	-------------------------------------

##### Returns

Status of setPeerEthCapability, i.e., success or applicable status code

#### 4.54.2.27.1.4 virtual telux::common::Status telux::data::IDataLinkManager::setLocalEthOperatingMode ( EthModeType *ethModeType*, telux::common::ResponseCallback *callback = nullptr* ) [pure virtual]

Sets the local ethernet link operating mode. This API can be used to change the local device ethernet data rate and operating mode, for example, when the remote end of the Ethernet link requires a modified mode due to a thermal threshold being crossed this API should be used.

On platforms with access control enabled, the caller needs to have TELUX\_DATA\_LINK\_CONFIG permission to successfully invoke this API.

##### Parameters

in	<i>ethModeType</i>	Provides the suggested ethernet speed and operating mode (MII variant)
in	<i>callback</i>	Optional callback to get the response for setLocalEthOperatingMode.

##### Returns

Status of setLocalEthOperatingMode, i.e., success or applicable status code

#### 4.54.2.27.1.5 virtual telux::common::Status telux::data::IDataLinkManager::setPeerModeChangeRequestStatus ( LinkModeChangeStatus *status* ) [pure virtual]

Allows the client to provide the acknowledgement status from the remote end to the NAD that made the link operating mode update request.

The new ethernet operating mode will be suggested via [IDataLinkListener::onEthModeChangeRequest](#) in scenarios like when the temperature crosses the expected limit. This suggestion needs to be accepted and processed by the other end of ethernet connection. To complete the transition this API needs to be called with proper [LinkModeChangeStatus](#).

This API should be called when:

1. A request is accepted by the remote end [LinkModeChangeStatus](#).
2. The remote end successfully changes there ethernet data rate and operating mode.

Any failure response interrupts updating the ETH mode, which was triggered via [IDataLinkListener::onEthModeChangeRequest](#). In failure cases, the client needs to wait for the new ETH mode update request [IDataLinkListener::onEthModeChangeRequest](#) or, if needed, the user can use [setLocalEthOperatingMode](#).

On platforms with access control enabled, the caller needs to have TELUX\_DATA\_LINK\_CONFIG permission to successfully invoke this API.

##### Parameters

<i>status</i>	Current status of ETH mode change request
---------------	---

##### Returns

Status of setPeerModeChangeRequestStatus, i.e., success or applicable status code

**4.54.2.27.1.6** `virtual telux::common::Status telux::data::IDataLinkManager::registerListener ( std::weak_ptr< IDataLinkListener > listener ) [pure virtual]`

Registers with the Data Link Manager as a listener for service statuses and other events.

#### Parameters

in	<i>listener</i>	Pointer to the <a href="#">IDataLinkListener</a> object that processes the notification
----	-----------------	---

#### Returns

Status of registerListener success or suitable status code

**4.54.2.27.1.7** `virtual telux::common::Status telux::data::IDataLinkManager::deregisterListener ( std::weak_ptr< IDataLinkListener > listener ) [pure virtual]`

Removes a previously added listener.

#### Parameters

in	<i>listener</i>	Pointer to the <a href="#">IDataLinkListener</a> object that needs to be removed
----	-----------------	--

#### Returns

Status of deregisterListener success or suitable status code

### 4.54.2.28 class telux::data::IDataLinkListener

Interface for the Data Link listener object. Client needs to implement this interface to be notified of data link service notifications like onServiceStatusChange.

The listener methods can be invoked from multiple threads. The implementation should be thread safe.

#### Public member functions

- virtual void [onServiceStatusChange](#) ([telux::common::ServiceStatus](#) status)
- virtual void [onEthModeChangeRequest](#) ([EthModeType](#) ethModeType)
- virtual void [onEthModeChangeTransactionStatus](#) ([EthModeType](#) ethModeType, [LinkModeChangeStatus](#) status)
- virtual [~IDataLinkListener](#) ()

#### 4.54.2.28.1 Constructors and Destructors

#### 4.54.2.28.1.1 virtual telux::data::IDataLinkListener::~IDataLinkListener ( ) [virtual]

Destructor for [IDataLinkListener](#)

#### 4.54.2.28.2 Member Function Documentation

##### 4.54.2.28.2.1 virtual void telux::data::IDataLinkListener::onServiceStatusChange ( telux::common::↔ ServiceStatus *status* ) [virtual]

Called when the service status changes.

##### Parameters

in	<i>status</i>	- <a href="#">ServiceStatus</a>
----	---------------	---------------------------------

##### 4.54.2.28.2.2 virtual void telux::data::IDataLinkListener::onEthModeChangeRequest ( EthModeType *ethModeType* ) [virtual]

Requests a change in ethernet speed and operating mode (MII variant).

This is invoked by the platform, possibly due to thermal mitigation. This API is invoked to request that the client helps coordinate a change in the ethernet speed and operating mode. When this API is called, the client is expected to inform the peer about this request and get an acknowledgement whether the peer is moving to the requested mode `setPeerModeChangeRequestStatus`.

Since the ETH link will be down after the [onEthModeChangeRequest](#) is invoked, the client should use an interconnect other than ETH to convey the new mode information to the peer and obtain acknowledgment. Once the peer has successfully transitioned to the desired mode and updated the local ETH module, successful acknowledgment via `setPeerModeChangeRequestStatus` will make the ETH link usable.

On platforms with access control enabled, the caller needs to have `TELUX_DATA_LINK_CONFIG` permission to successfully invoke this API.

##### Parameters

in	<i>ethModeType</i>	Provides the suggested ethernet speed and operating mode (MII variant)
----	--------------------	--

##### 4.54.2.28.2.3 virtual void telux::data::IDataLinkListener::onEthModeChangeTransactionStatus ( EthModeType *ethModeType*, LinkModeChangeStatus *status* ) [virtual]

Informs about ethernet speed and operating mode (MII variant) status changes.

In case of a timeout or failure reported via this API, communication over ETH link would not be possible. A new ETH mode change request will be initiated via [onEthModeChangeRequest](#) when the temperature crosses the expected limit. However, to complete the transition to the new ETH mode, a successful acknowledgment within a certain time via `setPeerModeChangeRequestStatus` is required.

On platforms with access control enabled, the caller needs to have `TELUX_DATA_LINK_INFO` permission to successfully invoke this API.

**Parameters**

in	<i>EthModeType</i>	Provides the updated ethernet speed and operating mode (MII variant)
in	<i>status</i>	Current status of ETH mode change request

**4.54.2.29 class telux::data::DataProfile**

[DataProfile](#) class represents single data profile on the modem.

**Public member functions**

- [DataProfile](#) (int id, const std::string &name, const std::string &apn, const std::string &username, const std::string &password, [IpFamilyType](#) ipFamilyType, [TechPreference](#) techPref, [AuthProtocolType](#) authType, [ApnTypes](#) apnTypes)
- int [getId](#) ()
- std::string [getName](#) ()
- std::string [getApn](#) ()
- std::string [getUserName](#) ()
- std::string [getPassword](#) ()
- [TechPreference](#) [getTechPreference](#) ()
- [AuthProtocolType](#) [getAuthProtocolType](#) ()
- [IpFamilyType](#) [getIpFamilyType](#) ()
- [ApnTypes](#) [getApnTypes](#) ()
- std::string [toString](#) ()

**Static Public Attributes**

- static constexpr int [PROFILE\\_ID\\_INVALID](#) = -1

**4.54.2.29.1 Constructors and Destructors**

**4.54.2.29.1.1** `telux::data::DataProfile::DataProfile ( int id, const std::string & name, const std::string & apn, const std::string & username, const std::string & password, IpFamilyType ipFamilyType, TechPreference techPref, AuthProtocolType authType, ApnTypes apnTypes )`

**4.54.2.29.2 Member Function Documentation**

**4.54.2.29.2.1 int telux::data::DataProfile::getId ( )**

Get profile identifier.

**Returns**

profile id

**4.54.2.29.2.2 std::string telux::data::DataProfile::getName ( )**

Get profile name.

**Returns**

profile name

**4.54.2.29.2.3 std::string telux::data::DataProfile::getApn ( )**

Get Access Point Name (APN) name.

**Returns**

APN name

**4.54.2.29.2.4 std::string telux::data::DataProfile::getUserName ( )**

Get profile user name.

**Returns**

user name

**4.54.2.29.2.5 std::string telux::data::DataProfile::getPassword ( )**

Get profile password.

**Returns**

profile password

**4.54.2.29.2.6 TechPreference telux::data::DataProfile::getTechPreference ( )**

Get technology preference.

**Returns**

TechPreference [TechPreference](#)

#### 4.54.2.29.2.7 AuthProtocolType telux::data::DataProfile::getAuthProtocolType ( )

Get authentication preference.

##### Returns

AuthProtocolType [AuthProtocolType](#)

#### 4.54.2.29.2.8 IpFamilyType telux::data::DataProfile::getIpFamilyType ( )

Get IP Family type.

##### Returns

IpFamilyType [IpFamilyType](#)

#### 4.54.2.29.2.9 ApnTypes telux::data::DataProfile::getApnTypes ( )

Get Apn type mask.

##### Returns

ApnTypes [ApnTypes](#)

#### 4.54.2.29.2.10 std::string telux::data::DataProfile::toString ( )

Get the text related informative representation of this object.

##### Returns

String containing informative string.

### 4.54.2.29.3 Field Documentation

#### 4.54.2.29.3.1 constexpr int telux::data::DataProfile::PROFILE\_ID\_INVALID = -1 [static]

#### 4.54.2.30 class telux::data::IDataProfileListener

Listener class for getting profile change notification.

The methods in the listener can be invoked from multiple threads. It is client's responsibility to make sure the implementation is thread safe.

**Public member functions**

- virtual void [onServiceStatusChange](#) ([telux::common::ServiceStatus](#) status)
- virtual void [onProfileUpdate](#) (int profileId, [TechPreference](#) techPreference, [ProfileChangeEvent](#) event)
- virtual [~IDataProfileListener](#) ()

**4.54.2.30.1 Constructors and Destructors**

**4.54.2.30.1.1** virtual [telux::data::IDataProfileListener::~IDataProfileListener](#) ( ) [[virtual](#)]

Destructor of [IDataProfileListener](#)

**4.54.2.30.2 Member Function Documentation**

**4.54.2.30.2.1** virtual void [telux::data::IDataProfileListener::onServiceStatusChange](#) ( [telux::common::ServiceStatus](#) *status* ) [[virtual](#)]

This function is called when service status changes.

**Parameters**

in	<i>status</i>	- <a href="#">ServiceStatus</a>
----	---------------	---------------------------------

**4.54.2.30.2.2** virtual void [telux::data::IDataProfileListener::onProfileUpdate](#) ( int *profileId*, [TechPreference](#) *techPreference*, [ProfileChangeEvent](#) *event* ) [[virtual](#)]

This function is called when profile change happens.

**Parameters**

in	<i>profileId</i>	- ID of the updated profile.
in	<i>techPreference</i>	- <a href="#">TechPreference</a> .
in	<i>event</i>	- Event that caused the change in profile.

**4.54.2.31 class [telux::data::IDataProfileManager](#)**

[IDataProfileManager](#) is a primary interface for profile management.

**Public member functions**

- virtual [telux::common::ServiceStatus](#) [getServiceStatus](#) ()=0
- virtual bool [isSubsystemReady](#) ()=0
- virtual std::future< bool > [onSubsystemReady](#) ()=0
- virtual [telux::common::Status](#) [requestProfileList](#) (std::shared\_ptr< [IDataProfileListCallback](#) >



callback=nullptr)=0

- virtual `telux::common::Status createProfile` (const `ProfileParams` &profileParams, std::shared\_ptr< `IDataCreateProfileCallback` > callback=nullptr)=0
- virtual `telux::common::Status deleteProfile` (uint8\_t profileId, `TechPreference` techPreference, std::shared\_ptr< `telux::common::ICommandResponseCallback` > callback=nullptr)=0
- virtual `telux::common::Status modifyProfile` (uint8\_t profileId, const `ProfileParams` &profileParams, std::shared\_ptr< `telux::common::ICommandResponseCallback` > callback=nullptr)=0
- virtual `telux::common::Status queryProfile` (const `ProfileParams` &profileParams, std::shared\_ptr< `IDataProfileListCallback` > callback=nullptr)=0
- virtual `telux::common::Status requestProfile` (uint8\_t profileId, `TechPreference` techPreference, std::shared\_ptr< `IDataProfileCallback` > callback=nullptr)=0
- virtual int `getSlotId` ()=0
- virtual `telux::common::Status registerListener` (std::weak\_ptr< `telux::data::IDataProfileListener` > listener)=0
- virtual `telux::common::Status deregisterListener` (std::weak\_ptr< `telux::data::IDataProfileListener` > listener)=0
- virtual `~IDataProfileManager` ()

#### 4.54.2.31.1 Constructors and Destructors

4.54.2.31.1.1 virtual `telux::data::IDataProfileManager::~IDataProfileManager` ( ) [`virtual`]

Destructor for `IDataProfileManager`

#### 4.54.2.31.2 Member Function Documentation

4.54.2.31.2.1 virtual `telux::common::ServiceStatus telux::data::IDataProfileManager::getServiceStatus` ( ) [`pure virtual`]

Checks the status of Data profile manager and returns the result.

##### Returns

`SERVICE_AVAILABLE` If Data profile manager is ready for service. `SERVICE_UNAVAILABLE` If Data profile manager is temporarily unavailable. `SERVICE_FAILED` - If Data profile manager encountered an irrecoverable failure.

4.54.2.31.2.2 virtual `bool telux::data::IDataProfileManager::isSubsystemReady` ( ) [`pure virtual`]

Checks if the data profile manager is ready.

##### Returns

True if data profile subsystem is ready for service otherwise false.

**Deprecated**

Use getServiceStatus API.

**4.54.2.31.2.3** `virtual std::future<bool> telux::data::IDataProfileManager::onSubsystemReady ( )`  
`[pure virtual]`

Waits for data profile subsystem to be ready.

**Returns**

A future that caller can wait on to be notified when data profile subsystem is ready.

**Deprecated**

Use InitResponseCb callback in factory API getDataProfileManager.

**4.54.2.31.2.4** `virtual telux::common::Status telux::data::IDataProfileManager::requestProfileList (`  
`std::shared_ptr< IDataProfileListCallback > callback = nullptr ) [pure virtual]`

Request list of profiles supported by the device.

**Parameters**

<i>in, out</i>	<i>callback</i>	Callback pointer to get the response.
----------------	-----------------	---------------------------------------

**Returns**

Status of request profile i.e. success or suitable error code.

**4.54.2.31.2.5** `virtual telux::common::Status telux::data::IDataProfileManager::createProfile ( const`  
`ProfileParams & profileParams, std::shared_ptr< IDataCreateProfileCallback > callback =`  
`nullptr ) [pure virtual]`

Create profile based on data profile params.

On platforms with Access control enabled, Caller needs to have TELUX\_DATA\_PROFILE\_OPS permission to invoke this API successfully.

**Parameters**

<i>in</i>	<i>profileParams</i>	profileParams configuration to be passed for creating profile either for 3GPP or 3GPP2
<i>in, out</i>	<i>callback</i>	Callback pointer to get the result of create profile

**Returns**

Status of create profile i.e. success or suitable error code.

**4.54.2.31.2.6** `virtual telux::common::Status telux::data::IDataProfileManager::deleteProfile ( uint8_t profileId, TechPreference techPreference, std::shared_ptr< telux::common::ICommandResponseCallback > callback = nullptr ) [pure virtual]`

Delete profile corresponding to profile identifier.

The deletion of a profile does not affect profile index assignments.

On platforms with Access control enabled, Caller needs to have TELUX\_DATA\_PROFILE\_OPS permission to invoke this API successfully.

#### Parameters

in	<i>profileId</i>	Profile identifier
in	<i>techPreference</i>	Technology Preference like 3GPP / 3GPP2
in	<i>callback</i>	Callback pointer to get the result of delete profile

#### Returns

Status of delete profile i.e. success or suitable error code.

**4.54.2.31.2.7** `virtual telux::common::Status telux::data::IDataProfileManager::modifyProfile ( uint8_t profileId, const ProfileParams & profileParams, std::shared_ptr< telux::common::ICommandResponseCallback > callback = nullptr ) [pure virtual]`

Modify existing profile with new profile params.

On platforms with Access control enabled, Caller needs to have TELUX\_DATA\_PROFILE\_OPS permission to invoke this API successfully.

#### Parameters

in	<i>profileId</i>	Profile identifier of profile to be modified
in	<i>profileParams</i>	New profileParams configuration passed for updating existing profile
in	<i>callback</i>	Callback pointer to get the result of modify profile

#### Returns

Status of modify profile i.e. success or suitable error code.

**4.54.2.31.2.8** `virtual telux::common::Status telux::data::IDataProfileManager::queryProfile ( const ProfileParams & profileParams, std::shared_ptr< IDataProfileListCallback > callback = nullptr ) [pure virtual]`

Lookup modem profile/s based on given profile params.

**Parameters**

in	<i>profileParams</i>	<a href="#">ProfileParams</a> configuration to be passed
in	<i>callback</i>	Callback pointer to get the result of query profile

**Returns**

Status of query profile i.e. success or suitable error code.

**4.54.2.31.2.9** `virtual telux::common::Status telux::data::IDataProfileManager::requestProfile ( uint8_t profileId, TechPreference techPreference, std::shared_ptr< IDataProfileCallback > callback = nullptr ) [pure virtual]`

Get data profile corresponding to profile identifier.

**Parameters**

in	<i>profileId</i>	Profile identifier
in	<i>techPreference</i>	Technology preference <ul style="list-style-type: none"> <li><a href="#">TechPreference</a></li> </ul>
in	<i>callback</i>	Callback pointer to get the result of get profile by ID

**Returns**

Status of requestProfile i.e. success or suitable error code.

**4.54.2.31.2.10** `virtual int telux::data::IDataProfileManager::getSlotId ( ) [pure virtual]`

Get associated slot id for the Data Profile Manager.

**Returns**

SlotId

**4.54.2.31.2.11** `virtual telux::common::Status telux::data::IDataProfileManager::registerListener ( std::weak_ptr< telux::data::IDataProfileListener > listener ) [pure virtual]`

Listen for create, delete and modify profile events.

**Parameters**

in	<i>listener</i>	- Listener that processes the notification.
----	-----------------	---

**Returns**

[telux::common::Status](#)

**4.54.2.31.2.12** virtual telux::common::Status telux::data::IDataProfileManager::deregisterListener ( std::weak\_ptr< telux::data::IDataProfileListener > *listener* ) [pure virtual]

De-register listener.

#### Parameters

in	<i>listener</i>	- Listener to be de-registered.
----	-----------------	---------------------------------

#### Returns

[telux::common::Status](#)

### 4.54.2.32 class telux::data::IDataCreateProfileCallback

Interface for create profile callback object. Client needs to implement this interface to get single shot responses for command like create profile.

The methods in callback can be invoked from multiple different threads. The implementation should be thread safe.

#### Public member functions

- virtual void [onResponse](#) (int profileId, [telux::common::ErrorCode](#) error)

#### 4.54.2.32.1 Member Function Documentation

**4.54.2.32.1.1** virtual void telux::data::IDataCreateProfileCallback::onResponse ( int *profileId*, [telux::common::ErrorCode](#) *error* ) [virtual]

This function is called with the response to [IDataProfileManager::createProfile](#) API.

#### Parameters

in	<i>profileId</i>	created profile Id for the response. Use <a href="#">IDataProfileManager::requestProfile</a> to get the data profile
in	<i>error</i>	<a href="#">telux::common::ErrorCode</a>

### 4.54.2.33 class telux::data::IDataProfileListCallback

Interface for getting list of [DataProfile](#) using callback. Client needs to implement this interface to get single shot responses for commands like get profile list and query profile.

The methods in callback can be invoked from different threads. The implementation should be thread safe.

#### Public member functions

- virtual void [onProfileListResponse](#) (const std::vector< std::shared\_ptr< [DataProfile](#) >> &profiles, [telux::common::ErrorCode](#) error)

#### 4.54.2.33.1 Member Function Documentation

**4.54.2.33.1.1** `virtual void telux::data::IDataProfileListCallback::onProfileListResponse ( const std::vector< std::shared_ptr< DataProfile >> & profiles, telux::common::ErrorCode error ) [virtual]`

This function is called with the response to requestProfileList API or queryProfile API.

##### Parameters

in	<i>profiles</i>	List of profiles supported by the device
in	<i>error</i>	<a href="#">telux::common::ErrorCode</a>

#### 4.54.2.34 class telux::data::IDataProfileCallback

Interface for getting [DataProfile](#) using callback. Client needs to implement this interface to get single shot responses for command like create profile.

The methods in callback can be invoked from multiple different threads. The implementation should be thread safe.

##### Public member functions

- virtual void [onResponse](#) (const std::shared\_ptr< [DataProfile](#) > &profile, [telux::common::ErrorCode](#) error)

#### 4.54.2.34.1 Member Function Documentation

**4.54.2.34.1.1** `virtual void telux::data::IDataProfileCallback::onResponse ( const std::shared_ptr< DataProfile > & profile, telux::common::ErrorCode error ) [virtual]`

This function is called with the response to [IDataProfileManager::requestProfile](#) API.

##### Parameters

in	<i>profile</i>	Response of data profile
in	<i>error</i>	<a href="#">telux::common::ErrorCode</a>

#### 4.54.2.35 struct telux::data::DdsInfo

Specifies the DDS switch information.

##### Data fields

Type	Field	Description
<a href="#">DdsType</a>	type	
SlotId	slotId	Specifies DDS switch type

### 4.54.2.36 struct telux::data::BandInterferenceConfig

N79 5G/Wlan 5GHz interference avoidance configuration

#### Data fields

Type	Field	Description
<a href="#">BandPriority</a>	priority	
uint32_t	wlanWait↔ TimeInSec	Priority settings for N79/Wlan 5G
uint32_t	n79WaitTime↔ InSec	If Wlan 5GHz has higher priority and suffers signal drop, modem will wait for period of time specified here for Wlan signal to recover before enabling N79 5G.

### 4.54.2.37 class telux::data::IDataSettingsManager

Data Settings Manager class provides APIs related to the data subsystem settings. For example, ability to reset current network settings to factory settings, setting backhaul priority, and enabling roaming per PDN.

#### Public member functions

- virtual [telux::common::ServiceStatus getServiceStatus](#) ()=0
- virtual [telux::common::Status restoreFactorySettings](#) ([OperationType](#) operationType, [telux::common::ResponseCallback](#) callback=nullptr, bool isRebootNeeded=true)=0
- virtual [telux::common::Status setBackhaulPreference](#) (std::vector< [BackhaulType](#) > backhaulPref, [telux::common::ResponseCallback](#) callback=nullptr)=0
- virtual [telux::common::Status requestBackhaulPreference](#) ([RequestBackhaulPrefResponseCb](#) callback)=0
- virtual [telux::common::Status setBandInterferenceConfig](#) (bool enable, std::shared\_ptr< [BandInterferenceConfig](#) > config=nullptr, [telux::common::ResponseCallback](#) callback=nullptr)=0
- virtual [telux::common::Status requestBandInterferenceConfig](#) ([RequestBandInterferenceConfigResponseCb](#) callback)=0
- virtual [telux::common::Status requestDdsSwitch](#) ([DdsInfo](#) request, [telux::common::ResponseCallback](#) callback=nullptr)=0
- virtual [telux::common::Status requestCurrentDds](#) ([RequestCurrentDdsResponseCb](#) callback)=0
- virtual [telux::common::Status setWwanConnectivityConfig](#) (SlotId slotId, bool allow, [telux::common::ResponseCallback](#) callback=nullptr)=0
- virtual [telux::common::Status requestWwanConnectivityConfig](#) (SlotId slotId, [requestWwanConnectivityConfigResponseCb](#) callback)=0
- virtual bool [isDeviceDataUsageMonitoringEnabled](#) ()=0
- virtual [telux::common::Status setMacSecState](#) (bool enable, [telux::common::ResponseCallback](#) callback=nullptr)=0
- virtual [telux::common::Status requestMacSecState](#) ([RequestMacSecSateResponseCb](#) callback)=0

- virtual `telux::common::Status switchBackHaul` (`BackhaulInfo` source, `BackhaulInfo` dest, bool applyToAll=false, `telux::common::ResponseCallback` callback=nullptr)=0
- virtual `telux::common::Status registerListener` (std::weak\_ptr< `IDataSettingsListener` > listener)=0
- virtual `telux::common::Status deregisterListener` (std::weak\_ptr< `IDataSettingsListener` > listener)=0

#### 4.54.2.37.1 Member Function Documentation

##### 4.54.2.37.1.1 virtual `telux::common::ServiceStatus telux::data::IDataSettingsManager::getServiceStatus` ( ) [pure virtual]

Checks the status of Data Settings manager object and returns the result.

#### Returns

SERVICE\_AVAILABLE - If Data Settings manager object is ready for service.

SERVICE\_UNAVAILABLE - If Data Settings manager object is temporarily unavailable.

SERVICE\_FAILED - If Data Settings manager object encountered an irrecoverable failure.

##### 4.54.2.37.1.2 virtual `telux::common::Status telux::data::IDataSettingsManager::restoreFactorySettings` ( `OperationType` *operationType*, `telux::common::ResponseCallback` *callback = nullptr*, bool *isRebootNeeded = true* ) [pure virtual]

Resets current network settings to initial setting configured in factory. Factory settings are the initial network settings generated during manufacturing process. For the factory settings to take effect a reboot is required. Clients can choose if this API invocation should reboot the system or the client would take responsibility of rebooting it.

#### Parameters

in	<i>operationType</i>	<code>telux::data::OperationType</code>
in	<i>callback</i>	callback to get the response to restoreFactorySettings
in	<i>isRebootNeeded</i>	true: System is automatically rebooted after reverting to factory settings false: System is not rebooted after successful reset

#### Returns

Immediate status of restoreFactorySettings i.e. success or suitable status.

##### 4.54.2.37.1.3 virtual `telux::common::Status telux::data::IDataSettingsManager::setBackhaulPreference` ( std::vector< `BackhaulType` > *backhaulPref*, `telux::common::ResponseCallback` *callback = nullptr* ) [pure virtual]

Set backhaul preference for bridge0 (default bridge) traffic. Bridge0 Traffic routing to backhaul will be attempted on first to least preferred. For instance if backhaul vector contains ETH, USB, and WWAN, bridge0 traffic routing will be attempted on ETH first, then USB and finally WWAN backhaul.

Configuration changes will be persistent across reboots.



On platforms with Access control enabled, Caller needs to have TELUX\_DATA\_SETTING permission to invoke this API successfully.

### Parameters

in	<i>backhaulPref</i>	vector of <a href="#">telux::data::BackhaulType</a> which contains the order of backhaul preference to be used when connecting to external network. First element is most preferred and last element is least preferred backhaul.
in	<i>callback</i>	callback to get response for setBackhaulPreference.

### Returns

Status of setBackhaulPreference i.e. success or suitable status code.

**4.54.2.37.1.4 virtual telux::common::Status telux::data::IDataSettingsManager::request↔  
BackhaulPreference ( RequestBackhaulPrefResponseCb *callback* ) [pure  
virtual]**

Request current backhaul preference for bridge0 (default bridge) traffic.

### Parameters

in	<i>callback</i>	callback to get response for requestBackhaulPreference.
----	-----------------	---

### Returns

Status of requestBackhaulPreference i.e. success or suitable status code.

**4.54.2.37.1.5 virtual telux::common::Status telux::data::IDataSettingsManager::setBandInterference↔  
Config ( bool *enable*, std::shared\_ptr< BandInterferenceConfig > *config = nullptr*,  
telux::common::ResponseCallback *callback = nullptr* ) [pure virtual]**

Configure N79 5G and Wlan 5GHz band priority. Sets priority for modem to use either 5GHz Wlan or N79 5G band when they are both available to avoid interference. In case N79 5G is configured as higher priority: If N79 5G becomes available while 5G Wlan is enabled, Wlan (AP/Sta) will be moved to 2.4 GHz. If N79 5G becomes unavailable for [telux::data::BandInterferenceConfig::n79WaitTimeInSec](#) time period, Wlan will be moved to 5GHz. In case Wlan 5GHz is configured as higher priority: If Wlan 5GHz (AP/Sta) becomes available while N79 5G is enabled, N79 5G will be disabled. If Wlan 5GHz becomes unavailable for [telux::data::BandInterferenceConfig::wlanWaitTimeInSec](#) period and N79 5G is available, N79 will be enabled.

On platforms with Access control enabled, Caller needs to have TELUX\_DATA\_SETTING permission to invoke this API successfully.

### Parameters

in	<i>enable</i>	True: enable interference management. False: disable interference management
----	---------------	--

in	<i>config</i>	N79 5G /Wlan 5GHz band interference configuration <a href="#">telux::data::BandInterferenceConfig</a>
in	<i>callback</i>	callback to get response for setBandInterferenceConfig.

**Returns**

Status of setBandInterferenceConfig i.e. success or suitable status code.

**4.54.2.37.1.6** virtual `telux::common::Status telux::data::IDataSettingsManager::requestBandInterferenceConfig ( RequestBandInterferenceConfigResponseCb callback ) [pure virtual]`

Request N79 5G and Wlan 5GHz band priority settings. Request the configurations set by `telux::data::setBandInterferenceConfig`

**Parameters**

in	<i>callback</i>	callback to get response for requestBandInterferenceConfig.
----	-----------------	---

**Returns**

Status of requestBandInterferenceConfig i.e. success or suitable status code.

**4.54.2.37.1.7** virtual `telux::common::Status telux::data::IDataSettingsManager::requestDdsSwitch ( DdsInfo request, telux::common::ResponseCallback callback = nullptr ) [pure virtual]`

Allows the client to perform the DDS switch. Client has the option to either select permanent or temporary switch.

**Parameters**

in	<i>request</i>	Client has to provide the request <a href="#">telux::data::DdsInfo</a> .
----	----------------	--

in	<i>callback</i>	<p>Callback to get response for requestDdsSwitch. Possible ErrorCode in telux::common::ResponseCallback:</p> <ul style="list-style-type: none"> <li>• If the DDS switch is performed successfully <a href="#">telux::common::ErrorCode::SUCCESS</a></li> <li>• If the DDS switch request is rejected <a href="#">telux::common::ErrorCode::OPERATION_NOT_ALLOWED</a> The following scenarios are example of when a switch request will be rejected: <ol style="list-style-type: none"> <li>1. Slot1 is permanent DDS and the client attempts to trigger a permanent DDS switch on slot 1.</li> <li>2. During an MT/MO voice call and the client attempts to trigger a permanent DDS switch.</li> </ol> </li> <li>• If the DDS switch is allowed but due to some reason DDS switch failed <a href="#">telux::common::ErrorCode::GENERIC_FAILURE</a></li> </ul>
----	-----------------	---

**Returns**

Status of requestDdsSwitch, i.e., success or suitable status code.

**Note**

Eval: This is a new API and is being evaluated. It is subject to change and could break backwards compatibility.

#### 4.54.2.37.1.8 virtual telux::common::Status telux::data::IDataSettingsManager::requestCurrentDds ( RequestCurrentDdsResponseCb *callback* ) [pure virtual]

Request the current DDS slot information

**Parameters**

in	<i>callback</i>	Callback to get response for requestCurrentDds.
----	-----------------	---

**Returns**

Status of requestCurrentDds, i.e., success or suitable status code.

**Note**

Eval: This is a new API and is being evaluated. It is subject to change and could break backwards compatibility.

**4.54.2.37.1.9** `virtual telux::common::Status telux::data::IDataSettingsManager::setWwanConnectivity↔  
Config ( SlotId slotId, bool allow, telux::common::ResponseCallback callback = nullptr  
) [pure virtual]`

Allow/Disallow WWAN connectivity. Controls whether system should allow/disallow WWAN connectivity to cellular network. Default setting is allow WWAN connectivity to cellular network.

- If client selects to disallow WWAN connectivity, any further attempts to start data calls using [telux::data::IDataConnectionManager::startDataCall](#) will fail with [telux::common::ErrorCode::NOT\\_SUPPORTED](#). Data calls can be connected again only if client selects to allow WWAN connectivity.
- If client selects to disallow WWAN connectivity while data calls are already connected, all WWAN data calls will also be disconnected. Client will also receive [telux::data::IDataConnectionListener::onDataCallInfoChanged](#) notification with [telux::data::IDataCall](#) object status [telux::data::DataCallStatus::NET\\_NO\\_NET](#) for all impacted data calls. Configuration changes will be persistent across reboots.

On platforms with Access control enabled, Caller needs to have TELUX\_DATA\_SETTING permission to invoke this API successfully.

#### Parameters

in	<i>slotId</i>	Slot id on which WWAN connectivity to be allowed/disallowed
in	<i>allow</i>	True: allow connectivity, False: disallow connectivity
in	<i>callback</i>	optional callback to get response for setWwanConnectivityConfig.

#### Returns

Status of setWwanConnectivityConfig i.e. success or suitable status code.

**4.54.2.37.1.10** `virtual telux::common::Status telux::data::IDataSettingsManager::requestWwan↔  
ConnectivityConfig ( SlotId slotId, requestWwanConnectivityConfigResponseCb  
callback ) [pure virtual]`

Request current WWAN connectivity Configuration.

#### Parameters

in	<i>slotId</i>	Slot id for which WWAN connectivity to be reported.
in	<i>callback</i>	callback to get response for requestWwanConnectivityConfig.

#### Returns

Status of requestWwanConnectivityConfig i.e. success or suitable status code.

#### 4.54.2.37.1.11 `virtual bool telux::data::IDataSettingsManager::isDeviceDataUsageMonitoringEnabled ( ) [pure virtual]`

Request device data usage monitoring status

This function can be used to obtain the current status of device data usage monitoring.

#### Returns

Returns true if data usage monitoring is enabled, else false.

#### 4.54.2.37.1.12 `virtual telux::common::Status telux::data::IDataSettingsManager::setMacSecState ( bool enable, telux::common::ResponseCallback callback = nullptr ) [pure virtual]`

Allows the client to set the MacSec state.

- If client enables the MacSec, post that the packets over the ethernet link will be encrypted.
- If client disables the MacSec, post that the packets over the ethernet link will not be encrypted.

#### Parameters

in	<i>enable</i>	True: enable the MacSec, False: disable the MacSec.
in	<i>callback</i>	Callback to get the setMacSecState response.

#### Returns

Status of setMacSecState, i.e., success or suitable status code.

#### Note

Eval: This is a new API and is being evaluated. It is subject to change and could break backwards compatibility.

#### 4.54.2.37.1.13 `virtual telux::common::Status telux::data::IDataSettingsManager::requestMacSecState ( RequestMacSecStateResponseCb callback ) [pure virtual]`

Requests the current MacSec state.

#### Parameters

in	<i>callback</i>	callback to get response for requestMacSecState.
----	-----------------	--

#### Returns

Status of requestMacSecState, i.e., success or suitable status code.

#### Note

Eval: This is a new API and is being evaluated. It is subject to change and could break backwards compatibility.

**4.54.2.37.1.14 virtual telux::common::Status telux::data::IDataSettingsManager::switchBackHaul ( BackhaulInfo source, BackhaulInfo dest, bool applyToAll = false, telux::common::ResponseCallback callback = nullptr ) [pure virtual]**

Switch backhaul to be used by traffic. Provides the ability to re-route clients traffic from one backhaul to another. Clients must call this API for each backhaul switch. For instance, if the default bridge (bridge0) and the on-demand bridge (bridges created by VLANs) need to be re-routed to WLAN, this API must be called twice for the default profile ID and the on-demand profile ID.. If destination backhaul is WLAN (WLAN in Station Mode):

- Traffic associated with the default and on-demand bridges will be re-routed to WLAN backhaul.
- Client traffic can only be re-routed to WLAN backhaul if the station is connected to an external access point.
- VLANs mapped to WWAN backhaul will be automatically mapped to WLAN backhaul.
- Firewall and DMZ rules configured on WLAN backhaul (if configured before calling this API) will be automatically activated. If destination backhaul is WWAN:
  - Any VLAN profile ID mapping configured in the destination backhaul prior to calling this API will be applied automatically.
  - Any firewall or DMZ rule configured on WWAN backhaul before calling this API will be activated automatically.

#### Parameters

in	<i>source</i>	Backhaul <a href="#">telux::data::BackhaulInfo</a> to re-route traffic from
in	<i>dest</i>	Backhaul <a href="#">telux::data::BackhaulType</a> to re-route traffic to
in	<i>applyToAll</i>	Traffic on all source backhauls will be routed to dest backhauls if the source backhaul type is <a href="#">telux::data::BackhaulType::WLAN</a> , traffic on all WWAN backhauls (default and on-demand) will be routed to dest backhaul. if dest backhaul type is <a href="#">telux::data::BackhaulType::WWAN</a> traffic on source backhaul will be routed to WWAN backhauls (default and on-demand) based on vlan-backhaul binding set by <a href="#">telux::data::net::IVlanManager::bindToBackhaul</a>
in	<i>callback</i>	Optional callback to get the response for switchBackHaul.

#### Returns

Status of switchBackHaul, i.e., success or applicable status code

#### Note

Eval: This is a new API and is being evaluated. It is subject to change and could break backwards compatibility.

#### 4.54.2.37.1.15 virtual telux::common::Status telux::data::IDataSettingsManager::registerListener ( std::weak\_ptr< IDataSettingsListener > *listener* ) [pure virtual]

Register Data Settings Manager as listener for Data Service health events like data service available or data service not available.

##### Parameters

in	<i>listener</i>	pointer of <a href="#">IDataSettingsListener</a> object that processes the notification
----	-----------------	---

##### Returns

Status of registerListener success or suitable status code

#### 4.54.2.37.1.16 virtual telux::common::Status telux::data::IDataSettingsManager::deregisterListener ( std::weak\_ptr< IDataSettingsListener > *listener* ) [pure virtual]

Removes a previously added listener.

##### Parameters

in	<i>listener</i>	pointer of <a href="#">IDataSettingsListener</a> object that needs to be removed
----	-----------------	--

##### Returns

Status of deregisterListener success or suitable status code

#### 4.54.2.38 class telux::data::IDataSettingsListener

Interface for Data Settings listener object. Client needs to implement this interface to get access to Data Settings services notifications like onServiceStatusChange.

The methods in listener can be invoked from multiple different threads. The implementation should be thread safe.

##### Public member functions

- virtual void [onServiceStatusChange](#) ([telux::common::ServiceStatus](#) status)
- virtual void [onWwanConnectivityConfigChange](#) (SlotId slotId, bool isConnectivityAllowed)
- virtual void [onDdsChange](#) ([DdsInfo](#) currentState)
- virtual [~IDataSettingsListener](#) ()

#### 4.54.2.38.1 Constructors and Destructors

4.54.2.38.1.1 `virtual telux::data::IDataSettingsListener::~IDataSettingsListener ( ) [virtual]`

Destructor for [IDataSettingsListener](#)

#### 4.54.2.38.2 Member Function Documentation

4.54.2.38.2.1 `virtual void telux::data::IDataSettingsListener::onServiceStatusChange ( telux↔  
::common::ServiceStatus status ) [virtual]`

This function is called when service status changes.

##### Parameters

in	<i>status</i>	- <a href="#">ServiceStatus</a>
----	---------------	---------------------------------

4.54.2.38.2.2 `virtual void telux::data::IDataSettingsListener::onWwanConnectivityConfigChange ( SlotId slotId, bool isConnectivityAllowed ) [virtual]`

This function is called when WWAN backhaul connectivity config changes.

##### Parameters

in	<i>slotId</i>	- Slot Id for which connectivity has changed.
in	<i>isConnectivity↔ Allowed</i>	- Connectivity status allowed/disallowed.

4.54.2.38.2.3 `virtual void telux::data::IDataSettingsListener::onDdsChange ( DdsInfo currentState ) [virtual]`

Provides the current DDS state and is called whenever a DDS switch occurs.

##### Parameters

in	<i>currentState</i>	Provides the current DDS status. <ul style="list-style-type: none"> <li>Slot ID on which the DDS switch occurred.</li> <li>DDS switch type <a href="#">telux::data::DdsType</a>.</li> </ul>
----	---------------------	---

#### 4.54.2.39 struct telux::data::IPv4Info

IPv4 header info

##### Data fields

Type	Field	Description
string	srcAddr	address of the device that sends the packet.



Type	Field	Description
string	srcSubnetMask	
string	destAddr	address of receiving end
string	destSubnet↔ Mask	
TypeOfService	value	level of throughput, reliability, and delay
TypeOfService	mask	
IpProtocol	nextProtoId	Protocol ID (i.e TCP, UDP or ICMP )

#### 4.54.2.40 struct telux::data::IPv6Info

IPv6 header info

##### Data fields

Type	Field	Description
string	srcAddr	address of the device that sends the packet.
uint8_t	srcPrefixLen	source prefix length used to create subnet
string	destAddr	address of receiving end
uint8_t	dstPrefixLen	destination prefix length used to create subnet
IpProtocol	nextProtoId	Protocol ID (i.e TCP, UDP or ICMP )
TrafficClass	val	indicates the class or priority of the IPv6 packet, enables the ability to track specific traffic flows at the network layer.
TrafficClass	mask	
FlowLabel	flowLabel	Indicates that this packet belongs to a specific sequence of packets between a source and destination, requiring special handling by intermediate IPv6 routers.
uint8_t	natEnabled	

#### 4.54.2.41 struct telux::data::UdpInfo

UDP header info

##### Data fields

Type	Field	Description
PortInfo	src	Source port and range
PortInfo	dest	Destination port and range

#### 4.54.2.42 struct telux::data::TcpInfo

TCP header info

##### Data fields

Type	Field	Description
PortInfo	src	Source port and range
PortInfo	dest	Destination port and range

#### 4.54.2.43 struct telux::data::IcmpInfo

Internet Control Message Protocol (ICMP)

##### Data fields

Type	Field	Description
uint8_t	type	ICMP message type - RFC2780
uint8_t	code	ICMP message code - RFC2780

#### 4.54.2.44 struct telux::data::EspInfo

Encapsulating Security Payload

##### Data fields

Type	Field	Description
uint32_t	spi	Security Parameters Index

#### 4.54.2.45 class telux::data::IIPFilter

A IP filter class to add specific filters like what data will be allowed from the modem to the application processor. Only data packets that match the filter will be sent to the apps processor. Also used to configure Firewall rules.

##### Public member functions

- virtual [IPv4Info](#) `getIPv4Info ()=0`
- virtual `telux::common::Status` `setIPv4Info (const IPv4Info &ipv4Info)=0`
- virtual [IPv6Info](#) `getIPv6Info ()=0`
- virtual `telux::common::Status` `setIPv6Info (const IPv6Info &ipv6Info)=0`
- virtual [IpProtocol](#) `getIpProtocol ()=0`
- virtual [IpFamilyType](#) `getIpFamily ()=0`
- virtual `~IIPFilter ()`

##### 4.54.2.45.1 Constructors and Destructors

4.54.2.45.1.1 virtual `telux::data::IIPFilter::~IIPFilter ( ) [virtual]`

Destructor for [IIPFilter](#)

##### 4.54.2.45.2 Member Function Documentation

**4.54.2.45.2.1 virtual IPv4Info telux::data::llpFilter::getIPv4Info ( ) [pure virtual]**

Get the IPv4 header info

**Returns**

[telux::data::IPv4Info](#)

**4.54.2.45.2.2 virtual telux::common::Status telux::data::llpFilter::setIPv4Info ( const IPv4Info & *ipv4Info* ) [pure virtual]**

sets the IPv4 header info

**Parameters**

in	<i>ipv4Info</i>	IPv4 structure <a href="#">telux::data::IPv4Info</a>
----	-----------------	--

**Returns**

Immediate status of [setIPv4Info\(\)](#) request sent i.e. success or suitable status code.

**4.54.2.45.2.3 virtual IPv6Info telux::data::llpFilter::getIPv6Info ( ) [pure virtual]**

Get the IPv6 header info

**Returns**

[telux::data::IPv6Info](#)

**4.54.2.45.2.4 virtual telux::common::Status telux::data::llpFilter::setIPv6Info ( const IPv6Info & *ipv6Info* ) [pure virtual]**

sets the IPv6 header info

**Parameters**

in	<i>ipv6Info</i>	IPv6 structure <a href="#">telux::data::IPv6Info</a>
----	-----------------	--

**Returns**

Immediate status of [setIPv6Info\(\)](#) request sent i.e. success or suitable status code.

**4.54.2.45.2.5 virtual IpProtocol telux::data::llpFilter::getIpProtocol ( ) [pure virtual]**

Get the IpProtocol Number

**Returns**

[telux::data::IpProtocol](#)

**4.54.2.45.2.6 virtual IpFamilyType telux::data::IpFilter::getIpFamily ( ) [pure virtual]**

Get the IP family type

**Returns**

[telux::data::IpFamilyType](#)

**4.54.2.46 class telux::data::IUDPFilter**

This class represents a IP Filter for the UDP, get the new instance from [telux::data::DataFactory](#).

**Public member functions**

- virtual [UdpInfo](#) [getUdpInfo](#) ()=0
- virtual [telux::common::Status](#) [setUdpInfo](#) (const [UdpInfo](#) &udpInfo)=0
- virtual [~IUDPFilter](#) ()

**4.54.2.46.1 Constructors and Destructors****4.54.2.46.1.1 virtual telux::data::IUDPFilter::~IUDPFilter ( ) [virtual]**

Destructor for [IUDPFilter](#)

**4.54.2.46.2 Member Function Documentation****4.54.2.46.2.1 virtual UdpInfo telux::data::IUDPFilter::getUdpInfo ( ) [pure virtual]**

Get the UDP header info

**Returns**

[telux::data::UdpInfo](#)

**4.54.2.46.2.2 virtual telux::common::Status telux::data::IUDPFilter::setUdpInfo ( const UdpInfo &udpInfo ) [pure virtual]**

sets the UDP header info

**Parameters**

in	<i>udpInfo</i>	<a href="#">UdpInfo</a> structure <a href="#">telux::data::UdpInfo</a>
----	----------------	--

**Returns**

Immediate status of [setUdpInfo\(\)](#) request sent i.e. success or suitable status code.

#### 4.54.2.47 class telux::data::ITcpFilter

This class represents a IP Filter for the TCP, get the new instance from [telux::data::DataFactory](#).

##### Public member functions

- virtual [TcpInfo](#) [getTcpInfo](#) ()=0
- virtual [telux::common::Status](#) [setTcpInfo](#) (const [TcpInfo](#) &tcpInfo)=0
- virtual [~ITcpFilter](#) ()

#### 4.54.2.47.1 Constructors and Destructors

##### 4.54.2.47.1.1 virtual telux::data::ITcpFilter::~ITcpFilter ( ) [virtual]

Destructor for [ITcpFilter](#)

#### 4.54.2.47.2 Member Function Documentation

##### 4.54.2.47.2.1 virtual TcpInfo telux::data::ITcpFilter::getTcpInfo ( ) [pure virtual]

Get the TCP header info

##### Returns

[telux::data::TcpInfo](#)

##### 4.54.2.47.2.2 virtual telux::common::Status telux::data::ITcpFilter::setTcpInfo ( const TcpInfo & tcpInfo ) [pure virtual]

sets the TCP header info

##### Parameters

in	<i>tcpInfo</i>	<a href="#">TcpInfo</a> structure <a href="#">telux::data::TcpInfo</a>
----	----------------	--

##### Returns

Immediate status of [setTcpInfo\(\)](#) request sent i.e. success or suitable status code.

#### 4.54.2.48 class telux::data::IcmpFilter

This class represents a IP Filter for the ICMP, get the new instance from [telux::data::DataFactory](#).

##### Public member functions

- virtual [IcmpInfo](#) [getIcmpInfo](#) ()=0
- virtual [telux::common::Status](#) [setIcmpInfo](#) (const [IcmpInfo](#) &icmpInfo)=0

- virtual [~IcmpFilter](#) ()

#### 4.54.2.48.1 Constructors and Destructors

4.54.2.48.1.1 virtual [telux::data::IcmpFilter::~IcmpFilter](#) ( ) [virtual]

Destructor for [IcmpFilter](#)

#### 4.54.2.48.2 Member Function Documentation

4.54.2.48.2.1 virtual [IcmpInfo](#) [telux::data::IcmpFilter::getIcmpInfo](#) ( ) [pure virtual]

Get the ICMP header info

##### Returns

[telux::data::IcmpInfo](#)

4.54.2.48.2.2 virtual [telux::common::Status](#) [telux::data::IcmpFilter::setIcmpInfo](#) ( const [IcmpInfo](#) & *icmpInfo* ) [pure virtual]

sets the ICMP header info

##### Parameters

in	<i>icmpInfo</i>	<a href="#">TcpInfo</a> structure <a href="#">telux::data::IcmpInfo</a>
----	-----------------	---

##### Returns

Immediate status of [setIcmpInfo\(\)](#) request sent i.e. success or suitable status code.

#### 4.54.2.49 class [telux::data::IEspFilter](#)

This class represents a IP Filter for the ESP, get the new instance from [telux::data::DataFactory](#).

##### Public member functions

- virtual [EspInfo](#) [getEspInfo](#) ()=0
- virtual [telux::common::Status](#) [setEspInfo](#) (const [EspInfo](#) &espInfo)=0
- virtual [~IEspFilter](#) ()

#### 4.54.2.49.1 Constructors and Destructors

4.54.2.49.1.1 virtual [telux::data::IEspFilter::~IEspFilter](#) ( ) [virtual]

Destructor for [IEspFilter](#)

## 4.54.2.49.2 Member Function Documentation

### 4.54.2.49.2.1 virtual EspInfo telux::data::IEspFilter::getEspInfo ( ) [pure virtual]

Get the ESP header info

#### Returns

[telux::data::EspInfo](#)

### 4.54.2.49.2.2 virtual telux::common::Status telux::data::IEspFilter::setEspInfo ( const EspInfo & espInfo ) [pure virtual]

sets the ICMP header info

#### Parameters

in	<i>espInfo</i>	<a href="#">EspInfo</a> structure <a href="#">telux::data::EspInfo</a>
----	----------------	--

#### Returns

Immediate status of [setEspInfo\(\)](#) request sent i.e. success or suitable status code.

## 4.54.2.50 struct telux::data::RoamingStatus

Roaming Status.

#### Data fields

Type	Field	Description
bool	isRoaming	True: Roaming on, False: Roaming off
<a href="#">RoamingType</a>	type	International/Domestic. Valid only if roaming is on

## 4.54.2.51 struct telux::data::ServiceStatus

Data Service Status Info.

#### Data fields

Type	Field	Description
<a href="#">DataService↔State</a>	serviceState	
<a href="#">NetworkRat</a>	networkRat	

## 4.54.2.52 class telux::data::IServingSystemManager

Serving System Manager class provides APIs related to the serving system for data functionality. For example, ability to query or be notified about the state of the platform's WWAN PS data serving information.

**Public member functions**

- virtual [telux::common::ServiceStatus](#) `getServiceStatus ()=0`
- virtual [DrbStatus](#) `getDrbStatus ()=0`
- virtual [telux::common::Status](#) `requestServiceStatus (RequestServiceStatusResponseCb callback)=0`
- virtual [telux::common::Status](#) `requestRoamingStatus (RequestRoamingStatusResponseCb callback)=0`
- virtual [telux::common::Status](#) `requestNrIconType (RequestNrIconTypeResponseCb callback)=0`
- virtual [telux::common::Status](#) `makeDormant (telux::common::ResponseCallback callback=nullptr)=0`
- virtual [telux::common::Status](#) `registerListener (std::weak_ptr< IServingSystemListener > listener)=0`
- virtual [telux::common::Status](#) `deregisterListener (std::weak_ptr< IServingSystemListener > listener)=0`
- virtual `SlotId` `getSlotId ()=0`
- virtual `~IServingSystemManager ()`

**4.54.2.52.1 Constructors and Destructors**

**4.54.2.52.1.1** virtual [telux::data::IServingSystemManager::~IServingSystemManager \( \)](#) [**virtual**]

Destructor of [IServingSystemManager](#)

**4.54.2.52.2 Member Function Documentation**

**4.54.2.52.2.1** virtual [telux::common::ServiceStatus](#) [telux::data::IServingSystemManager::getServiceStatus \( \)](#) [**pure virtual**]

Checks the status of serving manager object and returns the result.

**Returns**

`SERVICE_AVAILABLE` - If serving manager object is ready for service.

`SERVICE_UNAVAILABLE` - If serving manager object is temporarily unavailable.

`SERVICE_FAILED` - If serving manager object encountered an irrecoverable failure.

**4.54.2.52.2.2** virtual [DrbStatus](#) [telux::data::IServingSystemManager::getDrbStatus \( \)](#) [**pure virtual**]

Get the dedicated radio bearer (DRB) status

**Returns**

current `DrbStatus` [DrbStatus](#).



#### 4.54.2.52.2.3 virtual telux::common::Status telux::data::IServingSystemManager::requestServiceStatus ( RequestServiceStatusResponseCb *callback* ) [pure virtual]

Queries the current serving network status

##### Parameters

in	<i>callback</i>	callback to get response for requestServiceStatus
----	-----------------	---

##### Returns

Status of requestServiceStatus i.e. success or suitable status code. if requestServiceStatus returns failure, callback will not be invoked.

#### 4.54.2.52.2.4 virtual telux::common::Status telux::data::IServingSystemManager::requestRoaming↔ Status ( RequestRoamingStatusResponseCb *callback* ) [pure virtual]

Queries the current roaming status

##### Parameters

in	<i>callback</i>	callback to get response for requestRoamingStatus
----	-----------------	---

##### Returns

Status of requestRoamingStatus i.e. success or suitable status code.

#### 4.54.2.52.2.5 virtual telux::common::Status telux::data::IServingSystemManager::requestNrIconType ( RequestNrIconTypeResponseCb *callback* ) [pure virtual]

Queries the NR icon type to be displayed based on the serving system that the device has acquired service on.

##### Parameters

in	<i>callback</i>	callback to get response for requestNrIconType
----	-----------------	--

##### Returns

Status of requestNrIconType i.e. success or suitable status code.

#### 4.54.2.52.2.6 virtual telux::common::Status telux::data::IServingSystemManager::makeDormant ( telux::common::ResponseCallback *callback* = nullptr ) [pure virtual]

Request modem switch to dormant state: Certain network operations can only be performed when modem is in dormant state. This API provides an ability for clients to request modem to immediately transition to dormant state for such scenarios.

Clients must ensure no data calls are in process of bring up/tear down and there is no traffic on any active data calls when this API is called.

**Parameters**

in	<i>callback</i>	optional callback to get the response of makeDormancy
----	-----------------	---

**Returns**

[telux::common::ErrorCode::SUCCESS](#) if request is honored by network.

[telux::common::ErrorCode::INVALID\\_STATE](#) is returned if:

- There is no active data calls
- Any Data calls is going through bring up/tear down
- There is data traffic on any active data calls If API fails, application is responsible for re-attempting operation at later time once the above conditions are met.

On platforms with Access control enabled, Caller needs to have TELUX\_DATA\_SERVICE\_MGMT permission to invoke this API successfully.

**4.54.2.52.2.7 virtual telux::common::Status telux::data::IServingSystemManager::registerListener ( std::weak\_ptr< IServingSystemListener > *listener* ) [pure virtual]**

Register a listener for specific updates from serving system.

**Parameters**

in	<i>listener</i>	Pointer of <a href="#">IServingSystemListener</a> object that processes the notification
----	-----------------	--

**Returns**

Status of registerListener i.e success or suitable status code.

**4.54.2.52.2.8 virtual telux::common::Status telux::data::IServingSystemManager::deregisterListener ( std::weak\_ptr< IServingSystemListener > *listener* ) [pure virtual]**

Deregister the previously added listener.

**Parameters**

in	<i>listener</i>	Previously registered <a href="#">IServingSystemListener</a> that needs to be removed
----	-----------------	---

**Returns**

Status of removeListener i.e. success or suitable status code

**4.54.2.52.2.9 virtual SlotId telux::data::IServingSystemManager::getSlotId ( ) [pure virtual]**

Get associated slot id for the Serving System Manager.

**Returns**

SlotId

**4.54.2.53 class telux::data::IServingSystemListener**

Listener class for data serving system change notification.

The listener method can be invoked from multiple different threads. Client needs to make sure that implementation is thread-safe. Note: Some APIs of this listener support an auto-suppress feature, where the invocation of the API will be suppressed, to prevent unnecessary wakeups and save power, when the system is in a suspended state, enabling the auto suppress feature is controlled using a platform configuration in tel.conf. If the platform is configured to suppress an API, that API will not be invoked during suspend. In this case, if a state change or event occurs in the modem, the client will not know about it via a listener indication. If the client is interested, it can get the latest state explicitly on resume.

**Public member functions**

- virtual void [onServiceStatusChange](#) ([telux::common::ServiceStatus](#) status)
- virtual void [onDrbStatusChanged](#) ([DrbStatus](#) status)
- virtual void [onServiceStateChanged](#) ([ServiceStatus](#) status)
- virtual void [onRoamingStatusChanged](#) ([RoamingStatus](#) status)
- virtual void [onNrIconTypeChanged](#) ([NrIconType](#) type)
- virtual [~IServingSystemListener](#) ()

**4.54.2.53.1 Constructors and Destructors****4.54.2.53.1.1 virtual telux::data::IServingSystemListener::~~IServingSystemListener ( ) [virtual]**

Destructor of [IServingSystemListener](#)

**4.54.2.53.2 Member Function Documentation****4.54.2.53.2.1 virtual void telux::data::IServingSystemListener::onServiceStatusChange ( telux↔  
::common::ServiceStatus *status* ) [virtual]**

This function is called when [telux::common::ServiceStatus](#) status changes. [telux::common::ServiceStatus](#) indicate whether this sub system ready to provide service.

**Parameters**

in	<i>status</i>	- <a href="#">ServiceStatus</a>
----	---------------	---------------------------------

#### 4.54.2.53.2.2 **virtual void telux::data::IServingSystemListener::onDrbStatusChanged ( DrbStatus *status* ) [virtual]**

This function is called whenever Drb status is changed.

##### Parameters

in	<i>status</i>	<a href="#">DrbStatus</a>
----	---------------	---------------------------

This API supports the auto-suppress feature.

#### 4.54.2.53.2.3 **virtual void telux::data::IServingSystemListener::onServiceStateChanged ( ServiceStatus *status* ) [virtual]**

This function is called whenever [telux::data:ServiceStatus](#) state is changed. [telux::data:ServiceStatus](#) indicate packet switch domain network status.

##### Parameters

in	<i>status</i>	<a href="#">ServiceStatus</a>
----	---------------	-------------------------------

This API supports the auto-suppress feature.

#### 4.54.2.53.2.4 **virtual void telux::data::IServingSystemListener::onRoamingStatusChanged ( RoamingStatus *status* ) [virtual]**

This function is called whenever roaming status is changed.

##### Parameters

in	<i>status</i>	<a href="#">RoamingStatus</a>
----	---------------	-------------------------------

This API supports the auto-suppress feature.

#### 4.54.2.53.2.5 **virtual void telux::data::IServingSystemListener::onNrIconTypeChanged ( NrIconType *type* ) [virtual]**

This function is called whenever NR icon type is changed.

##### Parameters

in	<i>type</i>	<a href="#">NrIconType</a>
----	-------------	----------------------------

This API supports the auto-suppress feature.

#### 4.54.2.54 union telux::data::DataCallEndReason. \_\_unnamed\_\_

##### Data fields

Type	Field	Description
MobileIp↔ ReasonCode	IpCode	
Internal↔ ReasonCode	internalCode	
CallManager↔ ReasonCode	cmCode	
SpecReason↔ Code	specCode	
PPPReason↔ Code	pppCode	
EHRPD↔ ReasonCode	ehrpdcCode	
Ipv6Reason↔ Code	ipv6Code	
Handoff↔ ReasonCode	handOffCode	

### 4.54.3 Enumeration Type Documentation

#### 4.54.3.1 enum telux::data::UsageResetReason [strong]

The event/reason that can trigger the data usage reset.

##### Enumerator

**SUBSYSTEM\_UNAVAILABLE** Subsystem is unavailable

**BACKHAUL\_SWITCHED** Backhaul is switched

**DEVICE\_DISCONNECTED** Device is disconnected

**WLAN\_DISABLED** WLAN is disabled

**WWAN\_DISCONNECTED** WWAN is disconnected. This will be sent even if only IPv4 or IPv6 goes down on an Ipv4v6 connection

#### 4.54.3.2 enum telux::data::IpFamilyType [strong]

Preferred IP family for the connection

##### Enumerator

**UNKNOWN**

**IPV4** IPv4 data connection

**IPV6** IPv6 data connection

**IPV4V6** IPv4 and IPv6 data connection

#### 4.54.3.3 enum telux::data::TechPreference [strong]

Technology Preference

##### Enumerator

**UNKNOWN**  
**TP\_3GPP** UMTS, LTE  
**TP\_3GPP2** CDMA  
**TP\_ANY** ANY (3GPP or 3GPP2)

#### 4.54.3.4 enum telux::data::AuthProtocolType [strong]

Authentication protocol preference type to be used for PDP context.

##### Enumerator

**AUTH\_NONE**  
**AUTH\_PAP** Password Authentication Protocol  
**AUTH\_CHAP** Challenge Handshake Authentication Protocol  
**AUTH\_PAP\_CHAP**

#### 4.54.3.5 enum telux::data::DataRestrictModeType [strong]

Defines the supported filtering mode of the packet data session.

##### Enumerator

**UNKNOWN**  
**DISABLE**  
**ENABLE**

#### 4.54.3.6 enum telux::data::ApnMaskType

Specifies APN types that can be set while creating or modifying a profile

##### Enumerator

**APN\_MASK\_TYPE\_DEFAULT** APN type for default/internet traffic  
**APN\_MASK\_TYPE\_IMS** APN type for the IP multimedia subsystem  
**APN\_MASK\_TYPE\_MMS** APN type for the multimedia messaging service  
**APN\_MASK\_TYPE\_DUN** APN type for the dial up network  
**APN\_MASK\_TYPE\_SUPL** APN type for secure user plane location  
**APN\_MASK\_TYPE\_HIPRI** APN type for high priority mobile data  
**APN\_MASK\_TYPE\_FOTA** APN type for over the air administration  
**APN\_MASK\_TYPE\_CBS** APN type for carrier branded services  
**APN\_MASK\_TYPE\_IA** APN type for initial attach  
**APN\_MASK\_TYPE\_EMERGENCY** APN type for emergency  
**APN\_MASK\_TYPE\_UT** APN type for UT  
**APN\_MASK\_TYPE\_MCX** APN type for mission critical service

#### 4.54.3.7 enum telux::data::DataCallStatus [strong]

Data call event status

##### Enumerator

**INVALID** Invalid  
**NET\_CONNECTED** Call is connected  
**NET\_NO\_NET** Call is disconnected  
**NET\_IDLE** Call is in idle state  
**NET\_CONNECTING** Call is in connecting state  
**NET\_DISCONNECTING** Call is in disconnecting state  
**NET\_RECONFIGURED** Interface is reconfigured, IP Address got changed  
**NET\_NEWADDR** A new IP address was added on an existing call  
**NET\_DELADDR** An IP address was removed from the existing interface

#### 4.54.3.8 enum telux::data::DataBearerTechnology [strong]

Bearer technology types (returned with getCurrentBearerTech).

##### Enumerator

**UNKNOWN** Unknown bearer.  
**CDMA\_1X** 1X technology.  
**EVDO\_REV0** CDMA Rev 0.  
**EVDO\_REVA** CDMA Rev A.  
**EVDO\_REVB** CDMA Rev B.  
**EHRPD** EHRPD.  
**FMC** Fixed mobile convergence.  
**HRPD** HRPD  
**BEARER\_TECH\_3GPP2\_WLAN** IWLAN  
**WCDMA** WCDMA.  
**GPRS** GPRS.  
**HSDPA** HSDPA.  
**HSUPA** HSUPA.  
**EDGE** EDGE.  
**LTE** LTE.  
**HSDPA\_PLUS** HSDPA+.  
**DC\_HSDPA\_PLUS** DC HSDPA+.  
**HSPA** HSPA  
**BEARER\_TECH\_64\_QAM** 64 QAM.  
**TDSCDMA** TD-SCDMA.  
**GSM** GSM  
**BEARER\_TECH\_3GPP\_WLAN** IWLAN  
**BEARER\_TECH\_5G** 5G

#### 4.54.3.9 enum telux::data::EndReasonType [strong]

Data call end/termination due to reason type.

**Enumerator**

**CE\_UNKNOWN**  
**CE\_MOBILE\_IP**  
**CE\_INTERNAL**  
**CE\_CALL\_MANAGER\_DEFINED**  
**CE\_3GPP\_SPEC\_DEFINED**  
**CE\_PPP**  
**CE\_EHRPD**  
**CE\_IPV6**  
**CE\_HANDOFF**

**4.54.3.10 enum telux::data::MobileIpReasonCode [strong]**

Data call end/termination reason code for [EndReasonType::CE\\_MOBILE\\_IP](#)

**Enumerator**

**CE\_MIP\_FA\_ERR\_REASON\_UNSPECIFIED**  
**CE\_MIP\_FA\_ERR\_ADMINISTRATIVELY\_PROHIBITED**  
**CE\_MIP\_FA\_ERR\_INSUFFICIENT\_RESOURCES**  
**CE\_MIP\_FA\_ERR\_MOBILE\_NODE\_AUTHENTICATION\_FAILURE**  
**CE\_MIP\_FA\_ERR\_HA\_AUTHENTICATION\_FAILURE**  
**CE\_MIP\_FA\_ERR\_REQUESTED\_LIFETIME\_TOO\_LONG**  
**CE\_MIP\_FA\_ERR\_MALFORMED\_REQUEST**  
**CE\_MIP\_FA\_ERR\_MALFORMED\_REPLY**  
**CE\_MIP\_FA\_ERR\_ENCAPSULATION\_UNAVAILABLE**  
**CE\_MIP\_FA\_ERR\_VJHC\_UNAVAILABLE**  
**CE\_MIP\_FA\_ERR\_REVERSE\_TUNNEL\_UNAVAILABLE**  
**CE\_MIP\_FA\_ERR\_REVERSE\_TUNNEL\_IS\_MANDATORY\_AND\_T\_BIT\_NOT\_SET**  
**CE\_MIP\_FA\_ERR\_DELIVERY\_STYLE\_NOT\_SUPPORTED**  
**CE\_MIP\_FA\_ERR\_MISSING\_NAI**  
**CE\_MIP\_FA\_ERR\_MISSING\_HA**  
**CE\_MIP\_FA\_ERR\_MISSING\_HOME\_ADDR**  
**CE\_MIP\_FA\_ERR\_UNKNOWN\_CHALLENGE**  
**CE\_MIP\_FA\_ERR\_MISSING\_CHALLENGE**  
**CE\_MIP\_FA\_ERR\_STALE\_CHALLENGE**  
**CE\_MIP\_HA\_ERR\_REASON\_UNSPECIFIED**  
**CE\_MIP\_HA\_ERR\_ADMINISTRATIVELY\_PROHIBITED**  
**CE\_MIP\_HA\_ERR\_INSUFFICIENT\_RESOURCES**  
**CE\_MIP\_HA\_ERR\_MOBILE\_NODE\_AUTHENTICATION\_FAILURE**  
**CE\_MIP\_HA\_ERR\_FA\_AUTHENTICATION\_FAILURE**  
**CE\_MIP\_HA\_ERR\_REGISTRATION\_ID\_MISMATCH**  
**CE\_MIP\_HA\_ERR\_MALFORMED\_REQUEST**  
**CE\_MIP\_HA\_ERR\_UNKNOWN\_HA\_ADDR**  
**CE\_MIP\_HA\_ERR\_REVERSE\_TUNNEL\_UNAVAILABLE**  
**CE\_MIP\_HA\_ERR\_REVERSE\_TUNNEL\_IS\_MANDATORY\_AND\_T\_BIT\_NOT\_SET**  
**CE\_MIP\_HA\_ERR\_ENCAPSULATION\_UNAVAILABLE**  
**CE\_MIP\_ERR\_REASON\_UNKNOWN**



#### 4.54.3.11 enum telux::data::InternalReasonCode [strong]

Data call end/termination reason code for [EndReasonType::CE\\_INTERNAL](#)

##### Enumerator

**CE\_RETRY**  
**CE\_INTERNAL\_ERROR**  
**CE\_CALL\_ENDED**  
**CE\_INTERNAL\_UNKNOWN\_CAUSE\_CODE**  
**CE\_UNKNOWN\_CAUSE\_CODE**  
**CE\_CLOSE\_IN\_PROGRESS**  
**CE\_NW\_INITIATED\_TERMINATION**  
**CE\_APP\_PREEMPTED**  
**CE\_ERR\_PDN\_IPV4\_CALL\_DISALLOWED**  
**CE\_ERR\_PDN\_IPV4\_CALL\_THROTTLED**  
**CE\_ERR\_PDN\_IPV6\_CALL\_DISALLOWED**  
**CE\_ERR\_PDN\_IPV6\_CALL\_THROTTLED**  
**CE\_MODEM\_RESTART**  
**CE\_PDP\_PPP\_NOT\_SUPPORTED**  
**CE\_UNPREFERRED\_RAT**  
**CE\_PHYS\_LINK\_CLOSE\_IN\_PROGRESS**  
**CE\_APN\_PENDING\_HANOVER**  
**CE\_PROFILE\_BEARER\_INCOMPATIBLE**  
**CE\_MMGSDI\_CARD\_EVT**  
**CE\_LPM\_OR\_PWR\_DOWN**  
**CE\_APN\_DISABLED**  
**CE\_MPIT\_EXPIRED**  
**CE\_IPV6\_ADDR\_TRANSFER\_FAILED**  
**CE\_TRAT\_SWAP\_FAILED**  
**CE\_EHRPD\_TO\_HRPD\_FALLBACK**  
**CE\_MANDATORY\_APN\_DISABLED**  
**CE\_MIP\_CONFIG\_FAILURE**  
**CE\_INTERNAL\_PDN\_INACTIVITY\_TIMER\_EXPIRED**  
**CE\_MAX\_V4\_CONNECTIONS**  
**CE\_MAX\_V6\_CONNECTIONS**  
**CE\_APN\_MISMATCH**  
**CE\_IP\_VERSION\_MISMATCH**  
**CE\_DUN\_CALL\_DISALLOWED**  
**CE\_INVALID\_PROFILE**  
**CE\_INTERNAL\_EPC\_NONEPC\_TRANSITION**  
**CE\_INVALID\_PROFILE\_ID**  
**CE\_INTERNAL\_CALL\_ALREADY\_PRESENT**  
**CE\_IFACE\_IN\_USE**  
**CE\_IP\_PDP\_MISMATCH**  
**CE\_APN\_DISALLOWED\_ON\_ROAMING**  
**CE\_APN\_PARAM\_CHANGE**  
**CE\_IFACE\_IN\_USE\_CFG\_MATCH**  
**CE\_NULL\_APN\_DISALLOWED**  
**CE\_THERMAL\_MITIGATION**

**CE\_SUBS\_ID\_MISMATCH**  
**CE\_DATA\_SETTINGS\_DISABLED**  
**CE\_DATA\_ROAMING\_SETTINGS\_DISABLED**  
**CE\_APN\_FORMAT\_INVALID**  
**CE\_DDS\_CALL\_ABORT**  
**CE\_VALIDATION\_FAILURE**  
**CE\_PROFILES\_NOT\_COMPATIBLE**  
**CE\_NULL\_RESOLVED\_APN\_NO\_MATCH**  
**CE\_INVALID\_APN\_NAME**

#### 4.54.3.12 enum telux::data::CallManagerReasonCode [strong]

Data call end/termination reason code for [EndReasonType::CE\\_CALL\\_MANAGER\\_DEFINED](#)

##### Enumerator

**CE\_CDMA\_LOCK**  
**CE\_INTERCEPT**  
**CE\_REORDER**  
**CE\_REL\_SO\_REJ**  
**CE\_INCOM\_CALL**  
**CE\_ALERT\_STOP**  
**CE\_ACTIVATION**  
**CE\_MAX\_ACCESS\_PROBE**  
**CE\_CCS\_NOT\_SUPPORTED\_BY\_BS**  
**CE\_NO\_RESPONSE\_FROM\_BS**  
**CE\_REJECTED\_BY\_BS**  
**CE\_INCOMPATIBLE**  
**CE\_ALREADY\_IN\_TC**  
**CE\_USER\_CALL\_ORIG\_DURING\_GPS**  
**CE\_USER\_CALL\_ORIG\_DURING\_SMS**  
**CE\_NO\_CDMA\_SRV**  
**CE\_MC\_ABORT**  
**CE\_PERSIST\_NG**  
**CE\_UIM\_NOT\_PRESENT**  
**CE\_RETRY\_ORDER**  
**CE\_ACCESS\_BLOCK**  
**CEACCESS\_BLOCK\_ALL**  
**CE\_IS707B\_MAX\_ACC**  
**CE\_THERMAL\_EMERGENCY**  
**CE\_CALL\_ORIG\_THROTTLED**  
**CE\_USER\_CALL\_ORIG\_DURING\_VOICE\_CALL**  
**CE\_CONF\_FAILED**  
**CE\_INCOM\_REJ**  
**CE\_NEW\_NO\_GW\_SRV**  
**CE\_NEW\_NO\_GPRS\_CONTEXT**  
**CE\_NEW\_ILLEGAL\_MS**  
**CE\_NEW\_ILLEGAL\_ME**  
**CE\_NEW\_GPRS\_SERVICES\_AND\_NON\_GPRS\_SERVICES\_NOT\_ALLOWED**  
**CE\_NEW\_GPRS\_SERVICES\_NOT\_ALLOWED**

**CE\_NEW\_MS\_IDENTITY\_CANNOT\_BE\_DERIVED\_BY\_THE\_NETWORK**  
**CE\_NEW\_IMPLICITLY\_DETACHED**  
**CE\_NEW\_PLMN\_NOT\_ALLOWED**  
**CE\_NEW\_LA\_NOT\_ALLOWED**  
**CE\_NEW\_GPRS\_SERVICES\_NOT\_ALLOWED\_IN\_THIS\_PLMN**  
**CE\_NEW\_PDP\_DUPLICATE**  
**CE\_NEW\_UE\_RAT\_CHANGE**  
**CE\_NEW\_CONGESTION**  
**CE\_NEW\_NO\_PDP\_CONTEXT\_ACTIVATED**  
**CE\_NEW\_ACCESS\_CLASS\_DSAC\_REJECTION**  
**CE\_PDP\_ACTIVATE\_MAX\_RETRY\_FAILED**  
**CE\_RAB\_FAILURE**  
**CE\_ESM\_UNKNOWN\_EPS\_BEARER\_CONTEXT**  
**CE\_DRB\_RELEASED\_AT\_RRC**  
**CE\_NAS\_SIG\_CONN\_RELEASED**  
**CE\_REASON\_EMM\_DETACHED**  
**CE\_EMM\_ATTACH\_FAILED**  
**CE\_EMM\_ATTACH\_STARTED**  
**CE\_LTE\_NAS\_SERVICE\_REQ\_FAILED**  
**CE\_ESM\_ACTIVE\_DEDICATED\_BEARER\_REACTIVATED\_BY\_NW**  
**CE\_ESM\_LOWER\_LAYER\_FAILURE**  
**CE\_ESM\_SYNC\_UP\_WITH\_NW**  
**CE\_ESM\_NW\_ACTIVATED\_DED\_BEARER\_WITH\_ID\_OF\_DEF\_BEARER**  
**CE\_ESM\_BAD\_OTA\_MESSAGE**  
**CE\_ESM\_DS\_REJECTED\_THE\_CALL**  
**CE\_ESM\_CONTEXT\_TRANSFERRED\_DUE\_TO\_IRAT**  
**CE\_DS\_EXPLICIT\_DEACT**  
**CE\_ESM\_LOCAL\_CAUSE\_NONE**  
**CE\_LTE\_NAS\_SERVICE\_REQ\_FAILED\_NO\_THROTTLE**  
**CE\_ACL\_FAILURE**  
**CE\_LTE\_NAS\_SERVICE\_REQ\_FAILED\_DS\_DISALLOW**  
**CE\_EMM\_T3417\_EXPIRED**  
**CE\_EMM\_T3417\_EXT\_EXPIRED**  
**CE\_LRRRC\_UL\_DATA\_CNF\_FAILURE\_TXN**  
**CE\_LRRRC\_UL\_DATA\_CNF\_FAILURE\_HO**  
**CE\_LRRRC\_UL\_DATA\_CNF\_FAILURE\_CONN\_REL**  
**CE\_LRRRC\_UL\_DATA\_CNF\_FAILURE\_RLF**  
**CE\_LRRRC\_UL\_DATA\_CNF\_FAILURE\_CTRL\_NOT\_CONN**  
**CE\_LRRRC\_CONN\_EST\_FAILURE**  
**CE\_LRRRC\_CONN\_EST\_FAILURE\_ABORTED**  
**CE\_LRRRC\_CONN\_EST\_FAILURE\_ACCESS\_BARRED**  
**CE\_LRRRC\_CONN\_EST\_FAILURE\_CELL\_RESEL**  
**CE\_LRRRC\_CONN\_EST\_FAILURE\_CONFIG\_FAILURE**  
**CE\_LRRRC\_CONN\_EST\_FAILURE\_TIMER\_EXPIRED**  
**CE\_LRRRC\_CONN\_EST\_FAILURE\_LINK\_FAILURE**  
**CE\_LRRRC\_CONN\_EST\_FAILURE\_NOT\_CAMPED**  
**CE\_LRRRC\_CONN\_EST\_FAILURE\_SI\_FAILURE**  
**CE\_LRRRC\_CONN\_EST\_FAILURE\_CONN\_REJECT**  
**CE\_LRRRC\_CONN\_REL\_NORMAL**  
**CE\_LRRRC\_CONN\_REL\_RLF**

**CE\_LRRRC\_CONN\_REL\_CRE\_FAILURE**  
**CE\_LRRRC\_CONN\_REL\_OOS\_DURING\_CRE**  
**CE\_LRRRC\_CONN\_REL\_ABORTED**  
**CE\_LRRRC\_CONN\_REL\_SIB\_READ\_ERROR**  
**CE\_DETACH\_WITH\_REATTACH\_LTE\_NW\_DETACH**  
**CE\_DETACH\_WITH\_OUT\_REATTACH\_LTE\_NW\_DETACH**  
**CE\_ESM\_PROC\_TIME\_OUT**  
**CE\_INVALID\_CONNECTION\_ID**  
**CE\_INVALID\_NSAPI**  
**CE\_INVALID\_PRI\_NSAPI**  
**CE\_INVALID\_FIELD**  
**CE\_RAB\_SETUP\_FAILURE**  
**CE\_PDP\_ESTABLISH\_MAX\_TIMEOUT**  
**CE\_PDP\_MODIFY\_MAX\_TIMEOUT**  
**CE\_PDP\_INACTIVE\_MAX\_TIMEOUT**  
**CE\_PDP\_LOWERLAYER\_ERROR**  
**CE\_PPD\_UNKNOWN\_REASON**  
**CE\_PDP\_MODIFY\_COLLISION**  
**CE\_PDP\_MBMS\_REQUEST\_COLLISION**  
**CE\_MBMS\_DUPLICATE**  
**CE\_SM\_PS\_DETACHED**  
**CE\_SM\_NO\_RADIO\_AVAILABLE**  
**CE\_SM\_ABORT\_SERVICE\_NOT\_AVAILABLE**  
**CE\_MESSAGE\_EXCEED\_MAX\_L2\_LIMIT**  
**CE\_SM\_NAS\_SRV\_REQ\_FAILURE**  
**CE\_RRC\_CONN\_EST\_FAILURE\_REQ\_ERROR**  
**CE\_RRC\_CONN\_EST\_FAILURE\_TAI\_CHANGE**  
**CE\_RRC\_CONN\_EST\_FAILURE\_RF\_UNAVAILABLE**  
**CE\_RRC\_CONN\_REL\_ABORTED\_IRAT\_SUCCESS**  
**CE\_RRC\_CONN\_REL\_RLF\_SEC\_NOT\_ACTIVE**  
**CE\_RRC\_CONN\_REL\_IRAT\_TO\_LTE\_ABORTED**  
**CE\_RRC\_CONN\_REL\_IRAT\_FROM\_LTE\_TO\_G\_CCO\_SUCCESS**  
**CE\_RRC\_CONN\_REL\_IRAT\_FROM\_LTE\_TO\_G\_CCO\_ABORTED**  
**CE\_IMSI\_UNKNOWN\_IN\_HSS**  
**CE\_IMEI\_NOT\_ACCEPTED**  
**CE\_EPS\_SERVICES\_AND\_NON\_EPS\_SERVICES\_NOT\_ALLOWED**  
**CE\_EPS\_SERVICES\_NOT\_ALLOWED\_IN\_PLMN**  
**CE\_MSC\_TEMPORARILY\_NOT\_REACHABLE**  
**CE\_CS\_DOMAIN\_NOT\_AVAILABLE**  
**CE\_ESM\_FAILURE**  
**CE\_MAC\_FAILURE**  
**CE\_SYNCH\_FAILURE**  
**CE\_UE\_SECURITY\_CAPABILITIES\_MISMATCH**  
**CE\_SECURITY\_MODE\_REJ\_UNSPECIFIED**  
**CE\_NON\_EPS\_AUTH\_UNACCEPTABLE**  
**CE\_CS\_FALLBACK\_CALL\_EST\_NOT\_ALLOWED**  
**CE\_NO\_EPS\_BEARER\_CONTEXT\_ACTIVATED**  
**CE\_EMM\_INVALID\_STATE**  
**CE\_NAS\_LAYER\_FAILURE**  
**CE\_MULTI\_PDN\_NOT\_ALLOWED**

**CE\_EMBMS\_NOT\_ENABLED**  
**CE\_PENDING\_REDIAL\_CALL\_CLEANUP**  
**CE\_EMBMS\_REGULAR\_DEACTIVATION**  
**CE\_TLB\_REGULAR\_DEACTIVATION**  
**CE\_LOWER\_LAYER\_REGISTRATION\_FAILURE**  
**CE\_DETACH\_EPS\_SERVICES\_NOT\_ALLOWED**  
**CE\_SM\_INTERNAL\_PDP\_DEACTIVATION**  
**CE\_UNSUPPORTED\_1X\_PREV**  
**CE\_CD\_GEN\_OR\_BUSY**  
**CE\_CD\_BILL\_OR\_AUTH**  
**CE\_CHG\_HDR**  
**CE\_EXIT\_HDR**  
**CE\_HDR\_NO\_SESSION**  
**CE\_HDR\_ORIG\_DURING\_GPS\_FIX**  
**CE\_HDR\_CS\_TIMEOUT**  
**CE\_HDR\_RELEASED\_BY\_CM**  
**CE\_COLLOC\_ACQ\_FAIL**  
**CE\_OTASP\_COMMIT\_IN\_PROG**  
**CE\_NO\_HYBR\_HDR\_SRV**  
**CE\_HDR\_NO\_LOCK\_GRANTED**  
**CE\_HOLD\_OTHER\_IN\_PROG**  
**CE\_HDR\_FADE**  
**CE\_HDR\_ACC\_FAIL**  
**CE\_CLIENT\_END**  
**CE\_NO\_SRV**  
**CE\_FADE**  
**CE\_REL\_NORMAL**  
**CE\_ACC\_IN\_PROG**  
**CE\_ACC\_FAIL**  
**CE\_REDIR\_OR\_HANDOFF**  
**CE\_CM\_UNKNOWN\_ERROR**  
**CE\_OFFLINE**  
**CE\_EMERGENCY\_MODE**  
**CE\_PHONE\_IN\_USE**  
**CE\_INVALID\_MODE**  
**CE\_INVALID\_SIM\_STATE**  
**CE\_NO\_COLLOC\_HDR**  
**CE\_CALL\_CONTROL\_REJECTED**  
**CE\_UNKNOWN**

#### 4.54.3.13 enum telux::data::SpecReasonCode [strong]

Data call end/termination reason code for [EndReasonType::CE\\_3GPP\\_SPEC\\_DEFINED](#)

##### Enumerator

**CE\_OPERATOR\_DETERMINED\_BARRING**  
**CE\_NAS\_SIGNALLING\_ERROR**  
**CE\_LLC\_SNDPCP\_FAILURE**  
**CE\_INSUFFICIENT\_RESOURCES**

**CE\_UNKNOWN\_APN**  
**CE\_UNKNOWN\_PDP**  
**CE\_AUTH\_FAILED**  
**CE\_GGSN\_REJECT**  
**CE\_ACTIVATION\_REJECT**  
**CE\_OPTION\_NOT\_SUPPORTED**  
**CE\_OPTION\_UNSUBSCRIBED**  
**CE\_OPTION\_TEMP\_OOO**  
**CE\_NSAPI\_ALREADY\_USED**  
**CE\_REGULAR\_DEACTIVATION**  
**CE\_QOS\_NOT\_ACCEPTED**  
**CE\_NETWORK\_FAILURE**  
**CE\_UMTS\_REACTIVATION\_REQ**  
**CE\_FEATURE\_NOT\_SUPPORTED**  
**CE\_TFT\_SEMANTIC\_ERROR**  
**CE\_TFT\_SYNTAX\_ERROR**  
**CE\_UNKNOWN\_PDP\_CONTEXT**  
**CE\_FILTER\_SEMANTIC\_ERROR**  
**CE\_FILTER\_SYNTAX\_ERROR**  
**CE\_PDP\_WITHOUT\_ACTIVE\_TFT**  
**CE\_IP\_V4\_ONLY\_ALLOWED**  
**CE\_IP\_V6\_ONLY\_ALLOWED**  
**CE\_SINGLE\_ADDR\_BEARER\_ONLY**  
**CE\_ESM\_INFO\_NOT\_RECEIVED**  
**CE\_PDN\_CONN\_DOES\_NOT\_EXIST**  
**CE\_MULTI\_CONN\_TO\_SAME\_PDN\_NOT\_ALLOWED**  
**CE\_MAX\_ACTIVE\_PDP\_CONTEXT\_REACHED**  
**CE\_UNSUPPORTED\_APN\_IN\_CURRENT\_PLMN**  
**CE\_INVALID\_TRANSACTION\_ID**  
**CE\_MESSAGE\_INCORRECT\_SEMANTIC**  
**CE\_INVALID\_MANDATORY\_INFO**  
**CE\_MESSAGE\_TYPE\_UNSUPPORTED**  
**CE\_MSG\_TYPE\_NONCOMPATIBLE\_STATE**  
**CE\_UNKNOWN\_INFO\_ELEMENT**  
**CE\_CONDITIONAL\_IE\_ERROR**  
**CE\_MSG\_AND\_PROTOCOL\_STATE\_UNCOMPATIBLE**  
**CE\_PROTOCOL\_ERROR**  
**CE\_APN\_TYPE\_CONFLICT**  
**CE\_INVALID\_PCSCF\_ADDRESS**  
**CE\_INTERNAL\_CALL\_PREEMPT\_BY\_HIGH\_PRIO\_APN**  
**CE\_EMM\_ACCESS\_BARRED**  
**CE\_EMERGENCY\_IFACE\_ONLY**  
**CE\_IFACE\_MISMATCH**  
**CE\_COMPANION\_IFACE\_IN\_USE**  
**CE\_IP\_ADDRESS\_MISMATCH**  
**CE\_IFACE\_AND\_POL\_FAMILY\_MISMATCH**  
**CE\_EMM\_ACCESS\_BARRED\_INFINITE\_RETRY**  
**CE\_AUTH\_FAILURE\_ON\_EMERGENCY\_CALL**  
**CE\_INVALID\_DNS\_ADDR**  
**CE\_INVALID\_PCSCF\_DNS\_ADDR**

**CE\_TEST\_LOOPBACK\_MODE\_A\_OR\_B\_ENABLED**  
**CE\_UNKNOWN**

#### 4.54.3.14 enum telux::data::PPPReasonCode [strong]

Data call end/termination reason code for [EndReasonType::CE\\_PPP](#)

##### Enumerator

**CE\_PPP\_TIMEOUT**  
**CE\_PPP\_AUTH\_FAILURE**  
**CE\_PPP\_OPTION\_MISMATCH**  
**CE\_PPP\_PAP\_FAILURE**  
**CE\_PPP\_CHAP\_FAILURE**  
**CE\_PPP\_CLOSE\_IN\_PROGRESS**  
**CE\_PPP\_NV\_REFRESH\_IN\_PROGRESS**  
**CE\_PPP\_UNKNOWN**

#### 4.54.3.15 enum telux::data::EHRPDReasonCode [strong]

Data call end/termination reason code for [EndReasonType::CE\\_EHRPD](#)

##### Enumerator

**CE\_EHRPD\_SUBS\_LIMITED\_TO\_V4**  
**CE\_EHRPD\_SUBS\_LIMITED\_TO\_V6**  
**CE\_EHRPD\_VSNCP\_TIMEOUT**  
**CE\_EHRPD\_VSNCP\_FAILURE**  
**CE\_EHRPD\_VSNCP\_3GPP2I\_GEN\_ERROR**  
**CE\_EHRPD\_VSNCP\_3GPP2I\_UNAUTH\_APN**  
**CE\_EHRPD\_VSNCP\_3GPP2I\_PDN\_LIMIT\_EXCEED**  
**CE\_EHRPD\_VSNCP\_3GPP2I\_NO\_PDN\_GW**  
**CE\_EHRPD\_VSNCP\_3GPP2I\_PDN\_GW\_UNREACH**  
**CE\_EHRPD\_VSNCP\_3GPP2I\_PDN\_GW\_REJ**  
**CE\_EHRPD\_VSNCP\_3GPP2I\_INSUFF\_PARAM**  
**CE\_EHRPD\_VSNCP\_3GPP2I\_RESOURCE\_UNAVAIL**  
**CE\_EHRPD\_VSNCP\_3GPP2I\_ADMIN\_PROHIBIT**  
**CE\_EHRPD\_VSNCP\_3GPP2I\_PDN\_ID\_IN\_USE**  
**CE\_EHRPD\_VSNCP\_3GPP2I\_SUBSCR\_LIMITATION**  
**CE\_EHRPD\_VSNCP\_3GPP2I\_PDN\_EXISTS\_FOR\_THIS\_APN**  
**CE\_EHRPD\_VSNCP\_3GPP2I\_RECONNECT\_NOT\_ALLOWED**  
**CE\_EHRPD\_UNKNOWN**

#### 4.54.3.16 enum telux::data::IIPv6ReasonCode [strong]

Data call end/termination reason code for [EndReasonType::CE\\_IPV6](#)

##### Enumerator

**CE\_PREFIX\_UNAVAILABLE**  
**CE\_IPV6\_ERR\_HRPD\_IPV6\_DISABLED**

**CE\_IPV6\_DISABLED****4.54.3.17 enum telux::data::HandoffReasonCode [strong]**

Data call end/termination reason code for [EndReasonType::CE\\_HANDOFF](#)

**Enumerator**

**CE\_VCER\_HANDOFF\_PREF\_SYS\_BACK\_TO\_SRAT**

**4.54.3.18 enum telux::data::ProfileChangeEvent [strong]**

Event due to which change in profile happened.

**Enumerator**

**CREATE\_PROFILE\_EVENT** Profile was created

**DELETE\_PROFILE\_EVENT** Profile was deleted

**MODIFY\_PROFILE\_EVENT** Profile was modified

**4.54.3.19 enum telux::data::OperationType [strong]**

This applies in architectures where the modem is attached to an External Application Processor(EAP). An API, like start/stop data call, INatManager, IFirewallManager can be invoked from the EAP or from the modems Internal Application Processor (IAP). This type specifies where the operation should be carried out.

**Enumerator**

**DATA\_LOCAL** Perform the operation on the processor where the API is invoked.

**DATA\_REMOTE** Perform the operation on the application processor other than where the API is invoked.

**4.54.3.20 enum telux::data::Direction [strong]**

Direction of firewall rule

**Enumerator**

**UPLINK** Uplink Direction

**DOWNLINK** Downlink Direction

**4.54.3.21 enum telux::data::InterfaceType [strong]**

Peripheral Interface type

**Enumerator**

**UNKNOWN** UNKNOWN interface

**WLAN** Wireless Local Area Network (WLAN)

**ETH** Ethernet (ETH)

**ECM** Ethernet Control Model (ECM)



**RNDIS** Remote Network Driver Interface Specification (RNDIS)

**MHI** Modem Host Interface (MHI)

**VMTAP0** Represents Virtio interface available in a VM

**VMTAP1** Represents Virtio interface available in a VM

#### 4.54.3.22 enum telux::data::BackhaulType [strong]

Specifies backhaul types

##### Enumerator

**ETH**

**USB** Ethernet Backhaul

**WLAN** USB Backhaul

**WWAN** WLAN Backhaul

**BLE** WWAN Backhaul with default profile ID set by  
telux::data::DataConnectionManager::setDefaultProfile

**MAX\_SUPPORTED** Bluetooth Backhaul

#### 4.54.3.23 enum telux::data::ServiceState [strong]

State of Service

##### Enumerator

**INACTIVE** Service is inactive

**ACTIVE** Service is Active

#### 4.54.3.24 enum telux::data::QosFlowStateChangeEvent [strong]

QOS flow state change type

##### Enumerator

**UNKNOWN** UNKNOWN state

**ACTIVATED** Flow activated

**MODIFIED** Flow modified

**DELETED** Flow deleted

#### 4.54.3.25 enum telux::data::IpTrafficClassType [strong]

QOS flow IP traffic class type

##### Enumerator

**UNKNOWN** UNKNOWN type

**CONVERSATIONAL** Conversational IP Traffic class

**STREAMING** Streaming IP Traffic class

**INTERACTIVE** Interactive IP Traffic class

**BACKGROUND** Background IP Traffic class

#### 4.54.3.26 enum telux::data::QosIPFlowMaskType

Specifies QOS IP Flow parameter mask

##### Enumerator

**MASK\_IP\_FLOW\_NONE**  
**MASK\_IP\_FLOW\_TRF\_CLASS** No parameters set  
**MASK\_IP\_FLOW\_DATA\_RATE\_MIN\_MAX** Traffic class

#### 4.54.3.27 enum telux::data::QosFlowMaskType

Specifies QOS Flow parameter mask

##### Enumerator

**MASK\_FLOW\_NONE**  
**MASK\_FLOW\_TX\_GRANTED** No parameters set  
**MASK\_FLOW\_RX\_GRANTED** TX Granted flow set  
**MASK\_FLOW\_TX\_FILTERS** RX Granted flow set  
**MASK\_FLOW\_RX\_FILTERS** TX filters set

#### 4.54.3.28 enum telux::data::EthModeType

Specifies the media-independent interface (MII) variant and data rate.

##### Enumerator

**ETHMODE\_UNKNOWN** Unknown  
**ETHMODE\_USXGMII\_10G** USXGMII 10G data rate  
**ETHMODE\_USXGMII\_5G** USXGMII 5G data rate  
**ETHMODE\_USXGMII\_2\_5G** USXGMII 2.5G data rate  
**ETHMODE\_USXGMII\_1G** USXGMII 1G data rate  
**ETHMODE\_USXGMII\_100M** USXGMII 100M data rate  
**ETHMODE\_USXGMII\_10M** USXGMII 10M data rate  
**ETHMODE\_SGMII\_2\_5G** SGMII 2.5G data rate  
**ETHMODE\_SGMII\_1G** SGMII 1G data rate  
**ETHMODE\_SGMII\_100M** SGMII 100M data rate

#### 4.54.3.29 enum telux::data::LinkModeChangeStatus [strong]

Link mode update request status.

##### Enumerator

**UNKNOWN**  
**ACCEPTED** Unknown status  
**COMPLETED** Request accepted  
**FAILED** Successfully completed  
**REJECTED** Request failed  
**TIMEOUT** Request rejected

#### 4.54.3.30 enum telux::data::BandPriority [strong]

Set priority between N79 5G and Wlan 5GHz Band

##### Enumerator

**N79**

**WLAN** N79 has higher priority

#### 4.54.3.31 enum telux::data::DdsType [strong]

Possible DDS switch types.

##### Enumerator

**PERMANENT**

**TEMPORARY** Permanently switch the DDS SIM Slot. Intended to be used when the client wants to stop data activities on the current DDS SIM slot and start doing data activities on the other SIM slot, on a Dual SIM Dual Standby (DSDS) device. Permanent switch is persistent across reboots.

#### 4.54.3.32 enum telux::data::DrbStatus [strong]

Dedicated Radio Bearer (DRB) status.

##### Enumerator

**ACTIVE** At least one of the physical links across all PDNs is UP

**DORMANT** All the Physlinks across all PDNs are DOWN

**UNKNOWN** No PDN is active

#### 4.54.3.33 enum telux::data::RoamingType [strong]

Roaming Type.

##### Enumerator

**UNKNOWN** Device roaming mode is unknown

**DOMESTIC** Device is in Domestic roaming network

**INTERNATIONAL** Device is in International roaming network

#### 4.54.3.34 enum telux::data::DataServiceState [strong]

Data Service State. Indicates whether data service is ready to setup a data call or not.

##### Enumerator

**UNKNOWN** Service State not available

**IN\_SERVICE** Service Available

**OUT\_OF\_SERVICE** Service Not Available

#### 4.54.3.35 enum telux::data::NetworkRat [strong]

Data Network RATs.

##### Enumerator

**UNKNOWN** UNKNOWN  
**CDMA\_1X** CDMA\_1X  
**CDMA\_EVDO** CDMA\_EVDO  
**GSM** GSM  
**WCDMA** WCDMA  
**LTE** LTE  
**TDSCDMA** TDSCDMA  
**NR5G** NR5G

#### 4.54.3.36 enum telux::data::NrlconType [strong]

NR icon type.

##### Enumerator

**NONE** Unspecified  
**BASIC** 5G basic  
**UWB** 5G ultrawide band

## 4.55 net

This section contains APIs related to data network configuration.

### 4.55.1 Data Structure Documentation

#### 4.55.1.1 struct telux::data::net::BridgeInfo

Structure to configure a software bridge for an interface

##### Data fields

Type	Field	Description
string	ifaceName	Interface name
<a href="#">BridgeInfoType</a>	ifaceType	Interface type
uint32_t	bandwidth	Bandwidth(in Mbps) required for software bridge

#### 4.55.1.2 class telux::data::net::IBridgeManager

[IBridgeManager](#) provides APIs to enable/disable and set/get/delete software bridges for various WLAN and Ethernet interfaces. It also provides interface to Subsystem Restart events by registering as listener. Notifications will be received when modem is ready/not ready.

##### Public member functions

- virtual [telux::common::ServiceStatus getServiceStatus](#) ()=0
- virtual bool [isSubsystemReady](#) ()=0
- virtual std::future< bool > [onSubsystemReady](#) ()=0
- virtual [telux::common::Status enableBridge](#) (bool enable, [telux::common::ResponseCallback](#) callback=nullptr)=0
- virtual [telux::common::Status addBridge](#) ([BridgeInfo](#) config, [telux::common::ResponseCallback](#) callback=nullptr)=0
- virtual [telux::common::Status requestBridgeInfo](#) ([BridgeInfoResponseCb](#) callback)=0
- virtual [telux::common::Status removeBridge](#) (std::string ifaceName, [telux::common::ResponseCallback](#) callback=nullptr)=0
- virtual [telux::common::Status registerListener](#) (std::weak\_ptr< [IBridgeListener](#) > listener)=0
- virtual [telux::common::Status deregisterListener](#) (std::weak\_ptr< [IBridgeListener](#) > listener)=0
- virtual [~IBridgeManager](#) ()

##### 4.55.1.2.1 Constructors and Destructors

**4.55.1.2.1.1 virtual telux::data::net::IBridgeManager::~~IBridgeManager ( ) [virtual]**

Destructor for [IBridgeManager](#)

**4.55.1.2.2 Member Function Documentation****4.55.1.2.2.1 virtual telux::common::ServiceStatus telux::data::net::IBridgeManager::getServiceStatus ( ) [pure virtual]**

Checks the status of Bridge manager and returns the result.

**Returns**

SERVICE\_AVAILABLE If Bridge manager object is ready for service. SERVICE\_UNAVAILABLE If Bridge manager object is temporarily unavailable. SERVICE\_FAILED If Bridge manager object encountered an irrecoverable failure.

**4.55.1.2.2.2 virtual bool telux::data::net::IBridgeManager::isSubsystemReady ( ) [pure virtual]**

Checks if the Bridge manager subsystem is ready.

**Returns**

True if the Bridge Manager is ready for service, otherwise returns false.

**Deprecated**

Use getServiceStatus API.

**4.55.1.2.2.3 virtual std::future<bool> telux::data::net::IBridgeManager::onSubsystemReady ( ) [pure virtual]**

Wait for Bridge manager subsystem to be ready.

**Returns**

A future that caller can wait until the Bridge Manager succeed/fail to be ready.

**Deprecated**

Use InitResponseCb callback in factory API getBridgeManager.

**4.55.1.2.2.4 virtual telux::common::Status telux::data::net::IBridgeManager::enableBridge ( bool enable, telux::common::ResponseCallback callback = nullptr ) [pure virtual]**

Enable/Disable the software bridge in the system. It will affect all the configured software bridges for various interfaces.

On platforms with Access control enabled, Caller needs to have TELUX\_DATA\_NETWORK\_CONFIG

permission to invoke this API successfully.

### Parameters

in	<i>enable</i>	TRUE to enable, FALSE to disable the bridge
in	<i>callback</i>	Optional callback to get the response for enableBridge

### Returns

Status of enableBridge request i.e. success or suitable status code.

#### 4.55.1.2.2.5 **virtual telux::common::Status telux::data::net::IBridgeManager::addBridge ( BridgeInfo config, telux::common::ResponseCallback callback = nullptr ) [pure virtual]**

Add software bridge configuration for an interface.

On platforms with Access control enabled, Caller needs to have TELUX\_DATA\_NETWORK\_CONFIG permission to invoke this API successfully.

### Parameters

in	<i>config</i>	configuration for an interface
in	<i>callback</i>	Optional callback to get the response for addBridge

### Returns

Status of addBridge request i.e. success or suitable status code.

#### 4.55.1.2.2.6 **virtual telux::common::Status telux::data::net::IBridgeManager::requestBridgeInfo ( BridgeInfoResponseCb callback ) [pure virtual]**

Request information about all the software bridge configurations in the system

### Parameters

in	<i>callback</i>	Response callback with list of bridge configurations
----	-----------------	--

### Returns

Status of requestBridgeInfo request i.e. success or suitable status code.

#### 4.55.1.2.2.7 **virtual telux::common::Status telux::data::net::IBridgeManager::removeBridge ( std::string ifaceName, telux::common::ResponseCallback callback = nullptr ) [pure virtual]**

Delete a software bridge configuration for an interface.

On platforms with Access control enabled, Caller needs to have TELUX\_DATA\_NETWORK\_CONFIG permission to invoke this API successfully.

**Parameters**

in	<i>ifaceName</i>	Name of the interface whose configuration needs to be deleted
in	<i>callback</i>	Optional callback to get the response for removeBridge

**Returns**

Status of removeBridge request i.e. success or suitable status code.

#### 4.55.1.2.2.8 virtual telux::common::Status telux::data::net::IBridgeManager::registerListener ( std::weak\_ptr< IBridgeListener > *listener* ) [pure virtual]

Register Bridge Manager as listener for Data Service health events like data service available or data service not available.

**Parameters**

in	<i>listener</i>	pointer of <a href="#">IBridgeListener</a> object that processes the notification
----	-----------------	---

**Returns**

Status of registerListener success or suitable status code

#### 4.55.1.2.2.9 virtual telux::common::Status telux::data::net::IBridgeManager::deregisterListener ( std::weak\_ptr< IBridgeListener > *listener* ) [pure virtual]

Removes a previously added listener.

**Parameters**

in	<i>listener</i>	pointer of <a href="#">IBridgeListener</a> object that needs to be removed
----	-----------------	--

**Returns**

Status of deregisterListener success or suitable status code

### 4.55.1.3 class telux::data::net::IBridgeListener

Interface for Bridge listener object. Client needs to implement this interface to get access to Bridge services notifications like onServiceStatusChange.

The methods in listener can be invoked from multiple different threads. The implementation should be thread safe.

**Public member functions**

- virtual void [onServiceStatusChange](#) (telux::common::ServiceStatus status)
- virtual [~IBridgeListener](#) ()



### 4.55.1.3.1 Constructors and Destructors

4.55.1.3.1.1 `virtual telux::data::net::IBridgeListener::~IBridgeListener ( ) [virtual]`

Destructor for [IBridgeListener](#)

### 4.55.1.3.2 Member Function Documentation

4.55.1.3.2.1 `virtual void telux::data::net::IBridgeListener::onServiceStatusChange ( telux::common::↔ ServiceStatus status ) [virtual]`

This function is called when service status changes.

#### Parameters

in	<i>status</i>	- <a href="#">ServiceStatus</a>
----	---------------	---------------------------------

### 4.55.1.4 struct telux::data::net::FirewallConfig

Firewall configuration parameters

#### Data fields

Type	Field	Description
<a href="#">BackhaulInfo</a>	bhInfo	Backhaul Information to apply firewal settings on
bool	enable	True: Firewall enabled. False: Firewall disabled
bool	allowPackets	True: Packets that match rules will be allowed. False: Packets that match rules will be dropped

### 4.55.1.5 struct telux::data::net::DmzConfig

DMZ configuration parameters

#### Data fields

Type	Field	Description
<a href="#">BackhaulInfo</a>	bhInfo	Backhaul Information to apply firewal settings on
string	ipAddr	IP address for which DMZ will be enabled

### 4.55.1.6 struct telux::data::net::FirewallEntryInfo

Firewall rules parameters

#### Data fields

Type	Field	Description
shared_ptr< <a href="#">I↔ FirewallEntry</a> >	fwEntry	Shared pointer to firewall rules for the backhaul

Type	Field	Description
<a href="#">BackhaulInfo</a>	bhInfo	Backhaul Information to add firewall rules on

#### 4.55.1.7 class telux::data::net::IFirewallManager

FirewallManager is a primary interface that filters and controls the network traffic on a pre-configured set of rules. It also provides interface to Subsystem Restart events by registering as listener. Notifications will be received when modem is ready/not ready.

##### Public member functions

- virtual [telux::common::ServiceStatus](#) getServiceStatus ()=0
- virtual bool isSubsystemReady ()=0
- virtual std::future< bool > onSubsystemReady ()=0
- virtual [telux::common::Status](#) setFirewallConfig ([FirewallConfig](#) fwConfig, [telux::common::ResponseCallback](#) callback=nullptr)=0
- virtual [telux::common::Status](#) requestFirewallConfig ([BackhaulInfo](#) bhInfo, [FirewallConfigCb](#) callback)=0
- virtual [telux::common::Status](#) addFirewallEntry ([FirewallEntryInfo](#) entry, [AddFirewallEntryCb](#) callback=nullptr)=0
- virtual [telux::common::Status](#) requestFirewallEntries ([BackhaulInfo](#) bhInfo, [FirewallEntryInfoCb](#) callback)=0
- virtual [telux::common::Status](#) addHwAccelerationFirewallEntry ([FirewallEntryInfo](#) entry, [AddFirewallEntryCb](#) callback=nullptr)=0
- virtual [telux::common::Status](#) requestHwAccelerationFirewallEntries ([BackhaulInfo](#) bhInfo, [FirewallEntryInfoCb](#) callback)=0
- virtual [telux::common::Status](#) removeFirewallEntry ([BackhaulInfo](#) bhInfo, uint32\_t handle, [telux::common::ResponseCallback](#) callback=nullptr)=0
- virtual [telux::common::Status](#) enableDmz ([DmzConfig](#) config, [telux::common::ResponseCallback](#) callback=nullptr)=0
- virtual [telux::common::Status](#) disableDmz ([BackhaulInfo](#) bhInfo, const [IpFamilyType](#) ipType, [telux::common::ResponseCallback](#) callback=nullptr)=0
- virtual [telux::common::Status](#) requestDmzEntry ([BackhaulInfo](#) bhInfo, [DmzEntryInfoCb](#) callback)=0
- virtual [telux::common::Status](#) registerListener (std::weak\_ptr< [IFirewallListener](#) > listener)=0
- virtual [telux::common::Status](#) deregisterListener (std::weak\_ptr< [IFirewallListener](#) > listener)=0
- virtual [telux::data::OperationType](#) getOperationType ()=0
- virtual [telux::common::Status](#) setFirewall (int profileId, bool enable, bool allowPackets, [telux::common::ResponseCallback](#) callback=nullptr, SlotId slotId=DEFAULT\_SLOT\_ID)=0
- virtual [telux::common::Status](#) requestFirewallStatus (int profileId, [FirewallStatusCb](#) callback, SlotId slotId=DEFAULT\_SLOT\_ID)=0

- virtual `telux::common::Status addFirewallEntry` (int profileId, std::shared\_ptr< [IFirewallEntry](#) > entry, [telux::common::ResponseCallback](#) callback=nullptr, SlotId slotId=DEFAULT\_SLOT\_ID)=0
- virtual `telux::common::Status addHwAccelerationFirewallEntry` (int profileId, std::shared\_ptr< [IFirewallEntry](#) > entry, [AddFirewallEntryCb](#) callback=nullptr, SlotId slotId=DEFAULT\_SLOT\_ID)=0
- virtual `telux::common::Status requestHwAccelerationFirewallEntries` (int profileId, [FirewallEntriesCb](#) callback, SlotId slotId=DEFAULT\_SLOT\_ID)=0
- virtual `telux::common::Status requestFirewallEntries` (int profileId, [FirewallEntriesCb](#) callback, SlotId slotId=DEFAULT\_SLOT\_ID)=0
- virtual `telux::common::Status removeFirewallEntry` (int profileId, uint32\_t handle, [telux::common::ResponseCallback](#) callback=nullptr, SlotId slotId=DEFAULT\_SLOT\_ID)=0
- virtual `telux::common::Status enableDmz` (int profileId, const std::string ipAddr, [telux::common::ResponseCallback](#) callback=nullptr, SlotId slotId=DEFAULT\_SLOT\_ID)=0
- virtual `telux::common::Status disableDmz` (int profileId, const [telux::data::IpFamilyType](#) ipType, [telux::common::ResponseCallback](#) callback=nullptr, SlotId slotId=DEFAULT\_SLOT\_ID)=0
- virtual `telux::common::Status requestDmzEntry` (int profileId, [DmzEntriesCb](#) dmzCb, SlotId slotId=DEFAULT\_SLOT\_ID)=0
- virtual `~IFirewallManager` ()

#### 4.55.1.7.1 Constructors and Destructors

**4.55.1.7.1.1** virtual `telux::data::net::IFirewallManager::~IFirewallManager ( )` [virtual]

Destructor for [IFirewallManager](#)

#### 4.55.1.7.2 Member Function Documentation

**4.55.1.7.2.1** virtual `telux::common::ServiceStatus telux::data::net::IFirewallManager::getServiceStatus ( )` [pure virtual]

Checks the status of Firewall manager and returns the result.

##### Returns

SERVICE\_AVAILABLE If Firewall manager object is ready for service.

SERVICE\_UNAVAILABLE If Firewall manager object is temporarily unavailable.

SERVICE\_FAILED If Firewall manager object encountered an irrecoverable failure.

**4.55.1.7.2.2** virtual `bool telux::data::net::IFirewallManager::isSubsystemReady ( )` [pure virtual]

Checks if the Firewall manager subsystem is ready.

##### Returns

True if Firewall Manager is ready for service, otherwise returns false.

**Deprecated**

Use getServiceStatus API.

**4.55.1.7.2.3** `virtual std::future<bool> telux::data::net::IFirewallManager::onSubsystemReady ( )`  
`[pure virtual]`

Wait for Firewall manager subsystem to be ready.

**Returns**

A future that caller can wait on to be notified when firewall manager is ready.

**Deprecated**

Use InitResponseCb callback in factory API getFirewallManager.

**4.55.1.7.2.4** `virtual telux::common::Status telux::data::net::IFirewallManager::setFirewallConfig (`  
`FirewallConfig fwConfig, telux::common::ResponseCallback callback = nullptr )`  
`[pure virtual]`

Sets firewall configuration to enable or disable firewall and update configuration to drop or accept the packets matching the rules on slot ID, profile ID and backhaul type.

On platforms with Access control enabled, Caller needs to have TELUX\_DATA\_NETWORK\_CONFIG permission to invoke this API successfully.

**Parameters**

in	<i>config</i>	Firewall configuration telux::data::FirewallConfig.
----	---------------	---

**Returns**

Status of setFirewallConfig i.e. success or suitable status code.

**Note**

Eval: This is a new API and is being evaluated. It is subject to change and could break backwards compatibility.

**4.55.1.7.2.5** `virtual telux::common::Status telux::data::net::IFirewallManager::requestFirewallConfig (`  
`BackhaulInfo bhInfo, FirewallConfigCb callback ) [pure virtual]`

Request status of firewall settings on specific backhaul

**Parameters**

in	<i>bhInfo</i>	Backhaul Information to request firewall status for.
in	<i>callback</i>	callback to get the response of requestFirewallConfig

**Returns**

Status of requestFirewallConfig i.e. success or suitable status code.

**Note**

Eval: This is a new API and is being evaluated. It is subject to change and could break backwards compatibility.

#### 4.55.1.7.2.6 **virtual telux::common::Status telux::data::net::IFirewallManager::addFirewallEntry ( FirewallEntryInfo entry, AddFirewallEntryCb callback = nullptr ) [pure virtual]**

Adds the firewall rule to specific backhaul

On platforms with Access control enabled, Caller needs to have TELUX\_DATA\_NETWORK\_CONFIG permission to invoke this API successfully.

**Parameters**

in	<i>entries</i>	Firewall rules entries settings.
in	<i>callback</i>	optional callback to get the response addFirewallEntry

**Returns**

Status of addFirewallEntry i.e. success or suitable status code.

**Note**

Eval: This is a new API and is being evaluated. It is subject to change and could break backwards compatibility.

#### 4.55.1.7.2.7 **virtual telux::common::Status telux::data::net::IFirewallManager::requestFirewallEntries ( BackhaulInfo bhInfo, FirewallEntryInfoCb callback ) [pure virtual]**

Request Firewall rules for specific backhaul

**Parameters**

in	<i>bhInfo</i>	Backhaul Information to request firewall entries for.
in	<i>callback</i>	callback to get the response requestFirewallEntries.

**Returns**

Status of requestFirewallEntries i.e. success or suitable status code.

**Note**

Eval: This is a new API and is being evaluated. It is subject to change and could break backwards compatibility.

#### 4.55.1.7.2.8 virtual telux::common::Status telux::data::net::IFirewallManager::addHwAcceleration↔ FirewallEntry ( FirewallEntryInfo entry, AddFirewallEntryCb callback = nullptr ) [pure virtual]

Add Hardware Acceleration Rule Adds a firewall rule which will direct all traffic that matches the rule to bypass hardware acceleration, and take the software path.

These rules are per PDN. If the same rule applies to more than one PDN then this API needs to be invoked per PDN by specifying the corresponding profile ID of the PDN. [setFirewall](#) is not required for hw acceleration firewall rules to have an effect, which means that as soon as the rule is added successfully, packets matching the firewall rule will not be hw accelerated. Irrespective of whether firewall rules are set via [addFirewallEntry](#) and the type of firewall set (blacklist/whitelist) via [setFirewall](#), any packet matching rule added by [addHwAccelerationFirewallEntry](#) will not be hw accelerated and this packet will be routed by the S/w stack. On successful execution, a firewall handle will be provided in the callback which can be used to remove the firewall entry [removeFirewallEntry\(\)](#).

#### Parameters

in	<i>entries</i>	Firewall rules entries settings.
in	<i>callback</i>	optional callback to get the response addFirewallEntry

#### Returns

Status of addHwAccelerationFirewallEntry i.e. success or suitable status code.

#### Note

Eval: This is a new API and is being evaluated. It is subject to change and could break backwards compatibility.

#### 4.55.1.7.2.9 virtual telux::common::Status telux::data::net::IFirewallManager::requestHwAcceleration↔ FirewallEntries ( BackhaulInfo bhInfo, FirewallEntryInfoCb callback ) [pure virtual]

Request Hardware Acceleration rules Returns a list of hardware acceleration firewall entries.

#### Parameters

in	<i>bhInfo</i>	Backhaul Information to request firewall entries for.
in	<i>callback</i>	callback to get the response requestFirewallEntries.

#### Returns

Status of requestHwAccelerationFirewallEntries i.e. success or suitable status code.

#### Note

Eval: This is a new API and is being evaluated. It is subject to change and could break backwards compatibility.

**4.55.1.7.2.10** `virtual telux::common::Status telux::data::net::IFirewallManager::removeFirewallEntry ( BackhaulInfo bhInfo, uint32_t handle, telux::common::ResponseCallback callback = nullptr ) [pure virtual]`

Remove firewall entry set on particular backhaul

#### Parameters

in	<i>bhInfo</i>	Backhaul information to remove firewall entries from.
in	<i>handle</i>	handle of Firewall entry to be removed. To retrieve the handle, first use <a href="#">requestFirewallEntries()</a> to get the list of entries added in the system. And then use <a href="#">IFirewallEntry::getHandle()</a>
in	<i>callback</i>	callback to get the response removeFirewallEntry

#### Returns

Status of removeFirewallEntry i.e. success or suitable status code.

#### Note

Eval: This is a new API and is being evaluated. It is subject to change and could break backwards compatibility.

**4.55.1.7.2.11** `virtual telux::common::Status telux::data::net::IFirewallManager::enableDmz ( DmzConfig config, telux::common::ResponseCallback callback = nullptr ) [pure virtual]`

Enable demilitarized zone (DMZ) on particular backhaul

#### Parameters

in	<i>config</i>	DMZ configuration to be enabled
in	<i>callback</i>	optional callback to get the response addDmz

#### Returns

Status of enableDmz i.e. success or suitable status code.

#### Note

Eval: This is a new API and is being evaluated. It is subject to change and could break backwards compatibility.

**4.55.1.7.2.12** `virtual telux::common::Status telux::data::net::IFirewallManager::disableDmz ( BackhaulInfo bhInfo, const IpFamilyType ipType, telux::common::ResponseCallback callback = nullptr ) [pure virtual]`

Disable demilitarized zone (DMZ) on particular backhaul

**Parameters**

in	<i>bhInfo</i>	Backhaul on which DMZ will be disabled.
in	<i>ipType</i>	Specify IP type of the DMZ to be disabled
in	<i>callback</i>	optional callback to get the response removeDmz

**Returns**

Status of disableDmz i.e. success or suitable status code.

**Note**

Eval: This is a new API and is being evaluated. It is subject to change and could break backwards compatibility.

#### 4.55.1.7.2.13 virtual telux::common::Status telux::data::net::IFirewallManager::requestDmzEntry ( BackhaulInfo *bhInfo*, DmzEntryInfoCb *callback* ) [pure virtual]

Request DMZ entry on particular backhaul that was previously set using enableDmz API

**Parameters**

in	<i>bhInfo</i>	Backhaul info on which DMZ entries are requested.
in	<i>callback</i>	callback to get the response requestDmzEntry

**Returns**

Status of requestDmzEntry i.e. success or suitable status code.

**Note**

Eval: This is a new API and is being evaluated. It is subject to change and could break backwards compatibility.

#### 4.55.1.7.2.14 virtual telux::common::Status telux::data::net::IFirewallManager::registerListener ( std::weak\_ptr< IFirewallListener > *listener* ) [pure virtual]

Register Firewall Manager as listener for Data Service health events like data service available or data service not available.

**Parameters**

in	<i>listener</i>	pointer of <a href="#">IFirewallListener</a> object that processes the notification
----	-----------------	---

**Returns**

Status of registerListener success or suitable status code



**4.55.1.7.2.15** `virtual telux::common::Status telux::data::net::IFirewallManager::deregisterListener ( std::weak_ptr< IFirewallListener > listener ) [pure virtual]`

Removes a previously added listener.

#### Parameters

in	<i>listener</i>	pointer of <a href="#">IFirewallListener</a> object that needs to be removed
----	-----------------	--

#### Returns

Status of deregisterListener success or suitable status code

**4.55.1.7.2.16** `virtual telux::data::OperationType telux::data::net::IFirewallManager::getOperationType ( ) [pure virtual]`

Get the associated operation type for this instance.

#### Returns

OperationType of getOperationType i.e. LOCAL or REMOTE.

**4.55.1.7.2.17** `virtual telux::common::Status telux::data::net::IFirewallManager::setFirewall ( int profileId, bool enable, bool allowPackets, telux::common::ResponseCallback callback = nullptr, SlotId slotId = DEFAULT_SLOT_ID ) [pure virtual]`

Sets firewall configuration to enable or disable and update configuration to drop or accept the packets matching the rules.

On platforms with Access control enabled, Caller needs to have TELUX\_DATA\_NETWORK\_CONFIG permission to invoke this API successfully.

#### Parameters

in	<i>profileId</i>	Profile identifier on which firewall will be set.
in	<i>enable</i>	Indicates whether the firewall is enabled
in	<i>allowPackets</i>	Indicates whether to accept or drop packets matching the rules
in	<i>callback</i>	optional callback to get the response setFirewall
in	<i>slotId</i>	Specify slot id which has the sim that contains profile id

#### Returns

Status of setFirewall i.e. success or suitable status code.

#### Deprecated

Use telux::data::setFirewallConfig API to set firewall on any backhaul

**4.55.1.7.2.18** `virtual telux::common::Status telux::data::net::IFirewallManager::requestFirewallStatus ( int profileId, FirewallStatusCb callback, SlotId slotId = DEFAULT_SLOT_ID ) [pure virtual]`

Request status of firewall

#### Parameters

in	<i>profileId</i>	Profile identifier for which firewall status is requested.
in	<i>callback</i>	callback to get the response of requestFirewallStatus
in	<i>slotId</i>	Specify slot id which has the sim that contains profile id

#### Returns

Status of requestFirewallStatus i.e. success or suitable status code.

#### Deprecated

Use telux::data::requestFirewallConfig API to request firewall status on any backhaul

**4.55.1.7.2.19** `virtual telux::common::Status telux::data::net::IFirewallManager::addFirewallEntry ( int profileId, std::shared_ptr< IFirewallEntry > entry, telux::common::ResponseCallback callback = nullptr, SlotId slotId = DEFAULT_SLOT_ID ) [pure virtual]`

Adds the firewall rule

On platforms with Access control enabled, Caller needs to have TELUX\_DATA\_NETWORK\_CONFIG permission to invoke this API successfully.

#### Parameters

in	<i>profileId</i>	Profile identifier on which firewall rule will be added.
in	<i>entry</i>	Firewall entry based on protocol type
in	<i>callback</i>	optional callback to get the response addFirewallEntry
in	<i>slotId</i>	Specify slot id which has the sim that contains profile id

#### Returns

Status of addFirewallEntry i.e. success or suitable status code.

#### Deprecated

Use telux::data::addFirewallEntry API to add firewall rule on any backhaul

**4.55.1.7.2.20** `virtual telux::common::Status telux::data::net::IFirewallManager::addHwAcceleration↔ FirewallEntry ( int profileId, std::shared_ptr< IFirewallEntry > entry, AddFirewallEntryCb callback = nullptr, SlotId slotId = DEFAULT_SLOT_ID ) [pure virtual]`

Add Hardware Acceleration Rule Adds a firewall rule which will direct all traffic that matches the rule to bypass hardware acceleration, and take the software path.

These rules are per PDN. If the same rule applies to more than one PDN then this API needs to be invoked per PDN by specifying the corresponding profile ID of the PDN. [setFirewall](#) is not required for hw acceleration firewall rules to have an effect, which means that as soon as the rule is added successfully, packets matching the firewall rule will not be hw accelerated. Irrespective of whether firewall rules are set via [addFirewallEntry](#) and the type of firewall set (blacklist/whitelist) via [setFirewall](#), any packet matching rule added by [addHwAccelerationFirewallEntry](#) will not be hw accelerated and this packet will be routed by the S/w stack. On successful execution, a firewall handle will be provided in the callback which can be used to remove the firewall entry [removeFirewallEntry\(\)](#).

### Parameters

in	<i>profileId</i>	Profile identifier on which firewall rule will be added.
in	<i>entry</i>	Firewall entry based on protocol type
in	<i>callback</i>	optional callback to get the response <a href="#">addHwAccelerationFirewallEntry</a>
in	<i>slotId</i>	Specify slot id which has the sim that contains profile id

### Returns

Status of [addHwAccelerationFirewallEntry](#) i.e. success or suitable status code.

### Deprecated

Use `telux::data::addHwAccelerationFirewallEntry` API to add hardware acceleration firewall rule on any backhaul

**4.55.1.7.2.21** `virtual telux::common::Status telux::data::net::IFirewallManager::requestHwAccelerationFirewallEntries ( int profileId, FirewallEntriesCb callback, SlotId slotId = DEFAULT_SLOT_ID ) [pure virtual]`

Request Hardware Acceleration rules Returns a list of hardware acceleration firewall entries.

### Parameters

in	<i>profileId</i>	Profile identifier on which firewall entries are retrieved
in	<i>callback</i>	callback to get the response <code>requestHwAccelerationFirewallEntries</code>
in	<i>slotId</i>	Specify slot id which has the sim that contains profile id

### Returns

Status of `requestHwAccelerationFirewallEntries` i.e. success or suitable status code.

### Deprecated

Use `telux::data::requestHwAccelerationFirewallEntries` API to request hardware acceleration firewall rule on any backhaul

**4.55.1.7.2.22** `virtual telux::common::Status telux::data::net::IFirewallManager::requestFirewallEntries ( int profileId, FirewallEntriesCb callback, SlotId slotId = DEFAULT_SLOT_ID ) [pure virtual]`

Request Firewall rules

#### Parameters

in	<i>profileId</i>	Profile identifier on which firewall entries are retrieved.
in	<i>callback</i>	callback to get the response requestFirewallEntries.
in	<i>slotId</i>	Specify slot id which has the sim that contains profile id

#### Returns

Status of requestFirewallEntries i.e. success or suitable status code.

#### Deprecated

Use telux::data::requestFirewallEntries API to request firewall rules on any backhaul

**4.55.1.7.2.23** `virtual telux::common::Status telux::data::net::IFirewallManager::removeFirewallEntry ( int profileId, uint32_t handle, telux::common::ResponseCallback callback = nullptr, SlotId slotId = DEFAULT_SLOT_ID ) [pure virtual]`

Remove firewall entry

On platforms with Access control enabled, Caller needs to have TELUX\_DATA\_NETWORK\_CONFIG permission to invoke this API successfully.

#### Parameters

in	<i>profileId</i>	Profile identifier on which firewall entry will be removed.
in	<i>handle</i>	handle of Firewall entry to be removed. To retrieve the handle, first use <a href="#">requestFirewallEntries()</a> to get the list of entries added in the system. And then use <a href="#">IFirewallEntry::getHandle()</a> . Handle is also returned when hardware acceleration rule is added using <a href="#">addHwAccelerationFirewallEntry</a>
in	<i>callback</i>	callback to get the response removeFirewallEntry
in	<i>slotId</i>	Specify slot id which has the sim that contains profile id

#### Returns

Status of removeFirewallEntry i.e. success or suitable status code.

#### Deprecated

Use telux::data::removeFirewallEntry API to remove firewall rule from any backhaul

**4.55.1.7.2.24** `virtual telux::common::Status telux::data::net::IFirewallManager::enableDmz ( int profileId, const std::string ipAddr, telux::common::ResponseCallback callback = nullptr, SlotId slotId = DEFAULT_SLOT_ID ) [pure virtual]`

Enable demilitarized zone (DMZ)

On platforms with Access control enabled, Caller needs to have TELUX\_DATA\_NETWORK\_CONFIG permission to invoke this API successfully.

#### Parameters

in	<i>profileId</i>	Profile identifier on which DMZ will be enabled.
in	<i>ipAddr</i>	IP address for which DMZ will be enabled
in	<i>callback</i>	optional callback to get the response addDmz
in	<i>slotId</i>	Specify slot id which has the sim that contains profile id

#### Returns

Status of enableDmz i.e. success or suitable status code.

#### Deprecated

Use telux::data::enableDmz API to enable DMZ on any backhaul

**4.55.1.7.2.25** `virtual telux::common::Status telux::data::net::IFirewallManager::disableDmz ( int profileId, const telux::data::IpFamilyType ipType, telux::common::ResponseCallback callback = nullptr, SlotId slotId = DEFAULT_SLOT_ID ) [pure virtual]`

Disable demilitarized zone (DMZ)

On platforms with Access control enabled, Caller needs to have TELUX\_DATA\_NETWORK\_CONFIG permission to invoke this API successfully.

#### Parameters

in	<i>profileId</i>	Profile identifier on which DMZ will be disabled.
in	<i>ipType</i>	Specify IP type of the DMZ to be disabled
in	<i>callback</i>	optional callback to get the response removeDmz
in	<i>slotId</i>	Specify slot id which has the sim that contains profile id

#### Returns

Status of disableDmz i.e. success or suitable status code.

#### Deprecated

Use telux::data::disableDmz API to Disable DMZ on any backhaul

**4.55.1.7.2.26** `virtual telux::common::Status telux::data::net::IFirewallManager::requestDmzEntry ( int profileId, DmzEntriesCb dmzCb, SlotId slotId = DEFAULT_SLOT_ID ) [pure virtual]`

Request DMZ entry that was previously set using enableDmz API

#### Parameters

in	<i>profileId</i>	Profile identifier on which DMZ entries are requested.
in	<i>dmzCb</i>	callback to get the response requestDmzEntry
in	<i>slotId</i>	Specify slot id which has the sim that contains profile id

#### Returns

Status of requestDmzEntry i.e. success or suitable status code.

#### Deprecated

Use telux::data::requestDmzEntry API to request DMZ on any backhaul

### 4.55.1.8 class telux::data::net::IFirewallEntry

Firewall entry class is used for configuring firewall rules.

#### Public member functions

- virtual `std::shared_ptr< IIPFilter > getProtocolFilter ()=0`
- virtual `telux::data::Direction getDirection ()=0`
- virtual `telux::data::IpFamilyType getIpFamilyType ()=0`
- virtual `uint32_t getHandle ()=0`
- virtual `~IFirewallEntry ()`

#### Static Public Attributes

- static const `uint32_t INVALID_HANDLE = 0`

#### 4.55.1.8.1 Constructors and Destructors

**4.55.1.8.1.1** `virtual telux::data::net::IFirewallEntry::~IFirewallEntry ( ) [virtual]`

Destructor for [IFirewallEntry](#)

#### 4.55.1.8.2 Member Function Documentation

**4.55.1.8.2.1** `virtual std::shared_ptr<IIPFilter> telux::data::net::IFirewallEntry::getProtocolFilter ( ) [pure virtual]`

Get IProtocol filter type

**Returns**

[telux::data::IpFilter](#).

**4.55.1.8.2.2** virtual `telux::data::Direction` `telux::data::net::IFirewallEntry::getDirection ( )` [`pure virtual`]

Get firewall direction

**Returns**

[telux::data::Direction](#).

**4.55.1.8.2.3** virtual `telux::data::IpFamilyType` `telux::data::net::IFirewallEntry::getIpFamilyType ( )` [`pure virtual`]

Get Ip FamilyType

**Returns**

[telux::data::IpFamilyType](#).

**4.55.1.8.2.4** virtual `uint32_t` `telux::data::net::IFirewallEntry::getHandle ( )` [`pure virtual`]

Get the unique handle identifying this Firewall entry in the system

**Returns**

`uint32_t` handle if initialized or `INVALID_HANDLE` otherwise

**4.55.1.8.3 Field Documentation**

**4.55.1.8.3.1** `const uint32_t` `telux::data::net::IFirewallEntry::INVALID_HANDLE = 0` [`static`]

**4.55.1.9 class telux::data::net::IFirewallListener**

Interface for Firewall listener object. Client needs to implement this interface to get access to Firewall services notifications like `onServiceStatusChange`.

The methods in listener can be invoked from multiple different threads. The implementation should be thread safe.

**Public member functions**

- virtual void `onServiceStatusChange (telux::common::ServiceStatus status)`
- virtual `~IFirewallListener ()`

### 4.55.1.9.1 Constructors and Destructors

4.55.1.9.1.1 `virtual telux::data::net::IFirewallListener::~IFirewallListener ( ) [virtual]`

Destructor for [IFirewallListener](#)

### 4.55.1.9.2 Member Function Documentation

4.55.1.9.2.1 `virtual void telux::data::net::IFirewallListener::onServiceStatusChange ( telux::common::ServiceStatus status ) [virtual]`

This function is called when service status changes.

#### Parameters

in	<i>status</i>	- <a href="#">ServiceStatus</a>
----	---------------	---------------------------------

### 4.55.1.10 struct telux::data::net::L2tpSessionConfig

L2TP tunnel sessions configuration

#### Data fields

Type	Field	Description
uint32_t	locId	Local session id
uint32_t	peerId	Peer session id

### 4.55.1.11 struct telux::data::net::L2tpTunnelConfig

L2TP tunnel configuration

#### Data fields

Type	Field	Description
<a href="#">L2tpProtocol</a>	prot	Encapsulation protocols
uint32_t	locId	Local tunnel id
uint32_t	peerId	Peer tunnel id
uint32_t	localUdpPort	Local udp port - if UDP encapsulation is used
uint32_t	peerUdpPort	Peer udp port - if IP encapsulation is used
string	peerIpv6Addr	Peer IPv6 Address - for Ipv6 tunnels
string	peerIpv4Addr	Peer IPv4 Address - for Ipv4 tunnels
string	locIface	interface name to create L2TP tunnel on
<a href="#">IpFamilyType</a>	ipType	Ip family type <a href="#">telux::data::IpFamilyType</a>
vector< <a href="#">L2tpSessionConfig</a> >	sessionConfig	List of L2tp tunnel sessions



### 4.55.1.12 struct telux::data::net::L2tpSysConfig

L2TP Configuration

#### Data fields

Type	Field	Description
vector< <a href="#">L2tpTunnelConfig</a> >	configList	List of L2tp tunnel configurations
bool	enableMtu	Enable MTU size setting on underlying interfaces to avoid segmentation
bool	enableTcpMss	Enable TCP MSS clamping on L2TP interfaces to avoid segmentation
uint32_t	mtuSize	Current MTU size in bytes

### 4.55.1.13 class telux::data::net::IL2tpManager

L2tpManager is a primary interface for configuring L2TP Service. It also provides interface to Subsystem Restart events by registering as listener. Notifications will be received when modem is ready/not ready.

#### Public member functions

- virtual [telux::common::ServiceStatus getServiceStatus](#) ()=0
- virtual bool [isSubsystemReady](#) ()=0
- virtual std::future< bool > [onSubsystemReady](#) ()=0
- virtual [telux::common::Status setConfig](#) (bool enable, bool enableMss, bool enableMtu, [telux::common::ResponseCallback](#) callback=nullptr, uint32\_t mtuSize=0)=0
- virtual [telux::common::Status addTunnel](#) (const [L2tpTunnelConfig](#) &l2tpTunnelConfig, [telux::common::ResponseCallback](#) callback=nullptr)=0
- virtual [telux::common::Status requestConfig](#) ([L2tpConfigCb](#) l2tpConfigCb)=0
- virtual [telux::common::Status removeTunnel](#) (uint32\_t tunnelId, [telux::common::ResponseCallback](#) callback=nullptr)=0
- virtual [telux::common::Status registerListener](#) (std::weak\_ptr< [IL2tpListener](#) > listener)=0
- virtual [telux::common::Status deregisterListener](#) (std::weak\_ptr< [IL2tpListener](#) > listener)=0
- virtual [~IL2tpManager](#) ()

#### 4.55.1.13.1 Constructors and Destructors

4.55.1.13.1.1 virtual [telux::data::net::IL2tpManager::~~IL2tpManager](#) ( ) [[virtual](#)]

Destructor for [IL2tpManager](#)

### 4.55.1.13.2 Member Function Documentation

#### 4.55.1.13.2.1 `virtual telux::common::ServiceStatus telux::data::net::IL2tpManager::getServiceStatus ( ) [pure virtual]`

Checks the status of L2tp manager and returns the result.

#### Returns

`SERVICE_AVAILABLE` If L2tp manager is ready for service. `SERVICE_UNAVAILABLE` If L2tp manager is temporarily unavailable. `SERVICE_FAILED` - If L2tp manager encountered an irrecoverable failure.

#### 4.55.1.13.2.2 `virtual bool telux::data::net::IL2tpManager::isSubsystemReady ( ) [pure virtual]`

Checks if the L2tp manager subsystem is ready.

#### Returns

True if L2tp Manager is ready for service, otherwise returns false.

#### Note

This API will be deprecated. `getServiceStatus` API is recommended as an alternative

#### 4.55.1.13.2.3 `virtual std::future<bool> telux::data::net::IL2tpManager::onSubsystemReady ( ) [pure virtual]`

Wait for L2tp manager subsystem to be ready.

#### Returns

A future that caller can wait on to be notified when L2tp manager is ready.

#### Note

This API will be deprecated. Callback of type `InitResponseCb` argument in data factory API `getL2tpManager` is recommended as an alternative.

#### 4.55.1.13.2.4 `virtual telux::common::Status telux::data::net::IL2tpManager::setConfig ( bool enable, bool enableMss, bool enableMtu, telux::common::ResponseCallback callback = nullptr, uint32_t mtuSize = 0 ) [pure virtual]`

Enable L2TP for unmanaged Tunnel State

On platforms with Access control enabled, Caller needs to have `TELUX_DATA_NETWORK_CONFIG` permission to invoke this API successfully.

**Parameters**

in	<i>enable</i>	Enable/Disable L2TP for unmanaged tunnels.
in	<i>enableMss</i>	Enable/Disable TCP MSS to be clamped on L2TP interfaces to avoid Segmentation
in	<i>enableMtu</i>	Enable/Disable MTU size to be set on underlying interfaces to avoid fragmentation
in	<i>callback</i>	optional callback to get the response setConfig
in	<i>mtuSize</i>	optional MTU size in bytes. If not set, MTU size will be set to default 1422 bytes

**Returns**

Status of setConfig i.e. success or suitable status code.

**4.55.1.13.2.5 virtual telux::common::Status telux::data::net::IL2tpManager::addTunnel ( const L2tpTunnelConfig & I2tpTunnelConfig, telux::common::ResponseCallback callback = nullptr ) [pure virtual]**

Set L2TP Configuration for one tunnel

On platforms with Access control enabled, Caller needs to have TELUX\_DATA\_NETWORK\_CONFIG permission to invoke this API successfully.

**Parameters**

in	<i>I2tpTunnelConfig</i>	Configuration to be set <a href="#">telux::data::net::L2tpTunnelConfig</a>
in	<i>callback</i>	Optional callback to get the response addTunnel

**Returns**

Status of addTunnel i.e. success or suitable status code.

**4.55.1.13.2.6 virtual telux::common::Status telux::data::net::IL2tpManager::requestConfig ( L2tpConfigCb I2tpConfigCb ) [pure virtual]**

Get Current L2TP Configuration

**Parameters**

in	<i>I2tpConfigCb</i>	Asynchronous callback to get current L2TP configurations
----	---------------------	--

**Returns**

Status of requestConfig i.e. success or suitable status code.

**4.55.1.13.2.7** `virtual telux::common::Status telux::data::net::IL2tpManager::removeTunnel ( uint32_t tunnelId, telux::common::ResponseCallback callback = nullptr ) [pure virtual]`

Remove L2TP Tunnel

On platforms with Access control enabled, Caller needs to have TELUX\_DATA\_NETWORK\_CONFIG permission to invoke this API successfully.

#### Parameters

in	<i>tunnelId</i>	Tunnel ID to be removed
in	<i>callback</i>	optional callback to get the response removeConfig

#### Returns

Status of removeTunnel i.e. success or suitable status code.

**4.55.1.13.2.8** `virtual telux::common::Status telux::data::net::IL2tpManager::registerListener ( std::weak_ptr< IL2tpListener > listener ) [pure virtual]`

Register L2TP Manager as listener for Data Service health events like data service available or data service not available.

#### Parameters

in	<i>listener</i>	pointer of <a href="#">IL2tpListener</a> object that processes the notification
----	-----------------	---

#### Returns

Status of registerListener success or suitable status code

**4.55.1.13.2.9** `virtual telux::common::Status telux::data::net::IL2tpManager::deregisterListener ( std::weak_ptr< IL2tpListener > listener ) [pure virtual]`

Removes a previously added listener.

#### Parameters

in	<i>listener</i>	pointer of <a href="#">IL2tpListener</a> object that needs to be removed
----	-----------------	--

#### Returns

Status of deregisterListener success or suitable status code

#### 4.55.1.14 class telux::data::net::IL2tpListener

Interface for L2TP listener object. Client needs to implement this interface to get access to L2TP services notifications like onServiceStatusChange.

The methods in listener can be invoked from multiple different threads. The implementation should be thread safe.

##### Public member functions

- virtual void [onServiceStatusChange](#) ([telux::common::ServiceStatus](#) status)
- virtual [~IL2tpListener](#) ()

#### 4.55.1.14.1 Constructors and Destructors

4.55.1.14.1.1 virtual [telux::data::net::IL2tpListener::~~IL2tpListener](#) ( ) [[virtual](#)]

Destructor for [IL2tpListener](#)

#### 4.55.1.14.2 Member Function Documentation

4.55.1.14.2.1 virtual void [telux::data::net::IL2tpListener::onServiceStatusChange](#) ( [telux::common::ServiceStatus](#) *status* ) [[virtual](#)]

This function is called when service status changes.

##### Parameters

in	<i>status</i>	- <a href="#">ServiceStatus</a>
----	---------------	---------------------------------

#### 4.55.1.15 struct telux::data::net::NatConfig

Structure represents Network Address Translation (NAT) configuration

##### Data fields

Type	Field	Description
string	addr	Private IP address
uint16_t	port	Private port
uint16_t	globalPort	Global port
<a href="#">IpProtocol</a>	proto	IP protocol <a href="#">telux::data::IpProtocol</a>

#### 4.55.1.16 class telux::data::net::INatManager

NatManager is a primary interface for configuring static network address translation(SNAT) and DMZ (demilitarized zone). It also provides interface to Subsystem Restart events by registering as listener. Notifications will be received when modem is ready/not ready.

**Public member functions**

- virtual [telux::common::ServiceStatus](#) [getServiceStatus](#) ()=0
- virtual bool [isSubsystemReady](#) ()=0
- virtual std::future< bool > [onSubsystemReady](#) ()=0
- virtual [telux::common::Status](#) [addStaticNatEntry](#) (int profileId, const [NatConfig](#) &snatConfig, [telux::common::ResponseCallback](#) callback=nullptr, SlotId slotId=DEFAULT\_SLOT\_ID)=0
- virtual [telux::common::Status](#) [removeStaticNatEntry](#) (int profileId, const [NatConfig](#) &snatConfig, [telux::common::ResponseCallback](#) callback=nullptr, SlotId slotId=DEFAULT\_SLOT\_ID)=0
- virtual [telux::common::Status](#) [requestStaticNatEntries](#) (int profileId, [StaticNatEntriesCb](#) snatEntriesCb, SlotId slotId=DEFAULT\_SLOT\_ID)=0
- virtual [telux::common::Status](#) [registerListener](#) (std::weak\_ptr< [INatListener](#) > listener)=0
- virtual [telux::common::Status](#) [deregisterListener](#) (std::weak\_ptr< [INatListener](#) > listener)=0
- virtual [telux::data::OperationType](#) [getOperationType](#) ()=0
- virtual [~INatManager](#) ()

**4.55.1.16.1 Constructors and Destructors**

**4.55.1.16.1.1** virtual [telux::data::net::INatManager::~INatManager](#) ( ) [[virtual](#)]

Destructor for [INatManager](#)

**4.55.1.16.2 Member Function Documentation**

**4.55.1.16.2.1** virtual [telux::common::ServiceStatus](#) [telux::data::net::INatManager::getServiceStatus](#) ( )  
[[pure virtual](#)]

Checks the status of NAT manager and returns the result.

**Returns**

SERVICE\_AVAILABLE If Nat manager object is ready for service. SERVICE\_UNAVAILABLE If Nat manager object is temporarily unavailable. SERVICE\_FAILED - If Nat manager object encountered an irrecoverable failure.

**4.55.1.16.2.2 virtual bool telux::data::net::INatManager::isSubsystemReady ( ) [pure virtual]**

Checks if the NAT manager subsystem is ready.

**Returns**

True if NAT Manager is ready for service, otherwise returns false.

**Deprecated**

Use getServiceStatus API.

**4.55.1.16.2.3 virtual std::future<bool> telux::data::net::INatManager::onSubsystemReady ( ) [pure virtual]**

Wait for NAT manager subsystem to be ready.

**Returns**

A future that caller can wait on to be notified when NAT manager is ready.

**Deprecated**

Use InitResponseCb callback in factory API getNatManager.

**4.55.1.16.2.4 virtual telux::common::Status telux::data::net::INatManager::addStaticNatEntry ( int profileId, const NatConfig & snatConfig, telux::common::ResponseCallback callback = nullptr, SlotId slotId = DEFAULT\_SLOT\_ID ) [pure virtual]**

Adds a static Network Address Translation (NAT) entry in the NAT table, these entries are persistent across object, connection and reboot lifetimes. To remove an entry it needs a explicit call to [removeStaticNatEntry\(\)](#) API, it supports both IPv4 and IPv6

On platforms with Access control enabled, Caller needs to have TELUX\_DATA\_NETWORK\_CONFIG permission to invoke this API successfully.

**Parameters**

in	<i>profileId</i>	Profile identifier to which static entry will be mapped to.
in	<i>snatConfig</i>	snatConfiguration <a href="#">telux::data::net::NatConfig</a>
in	<i>callback</i>	optional callback to get the response addStaticNatEntry
in	<i>slotId</i>	Specify slot id which has the sim that contains profile id

**Returns**

Status of addStaticNatEntry i.e. success or suitable status code.

**4.55.1.16.2.5** `virtual telux::common::Status telux::data::net::INatManager::removeStaticNatEntry ( int profileId, const NatConfig & snatConfig, telux::common::ResponseCallback callback = nullptr, SlotId slotId = DEFAULT_SLOT_ID ) [pure virtual]`

Removes a static Network Address Translation (NAT) entry in the NAT table, it supports both IPv4 and IPv6

On platforms with Access control enabled, Caller needs to have TELUX\_DATA\_NETWORK\_CONFIG permission to invoke this API successfully.

#### Parameters

in	<i>profileId</i>	Profile identifier to which static entry will be removed from.
in	<i>snatConfig</i>	snatConfiguration <a href="#">telux::data::net::NatConfig</a>
in	<i>callback</i>	optional callback to get the response removeStaticNatEntry
in	<i>slotId</i>	Specify slot id which has the sim that contains profile id

#### Returns

Status of removeStaticNatEntry i.e. success or suitable status code.

**4.55.1.16.2.6** `virtual telux::common::Status telux::data::net::INatManager::requestStaticNatEntries ( int profileId, StaticNatEntriesCb snatEntriesCb, SlotId slotId = DEFAULT_SLOT_ID ) [pure virtual]`

Request list of static nat entries available in the NAT table

#### Parameters

in	<i>profileId</i>	Profile identifier to which static entries will be retrieved.
in	<i>snatEntriesCb</i>	Asynchronous callback to get the list of static Network Address Translation (NAT) entries
in	<i>slotId</i>	Specify slot id which has the sim that contains profile id

#### Returns

Status of requestStaticNatEntries i.e. success or suitable status code.

**4.55.1.16.2.7** `virtual telux::common::Status telux::data::net::INatManager::registerListener ( std::weak_ptr< INatListener > listener ) [pure virtual]`

Register Nat Manager as listener for Data Service health events like data service available or data service not available.

#### Parameters

in	<i>listener</i>	pointer of <a href="#">INatListener</a> object that processes the notification
----	-----------------	--



**Returns**

Status of registerListener success or suitable status code

**4.55.1.16.2.8** `virtual telux::common::Status telux::data::net::INatManager::deregisterListener ( std::weak_ptr< INatListener > listener ) [pure virtual]`

Removes a previously added listener.

**Parameters**

in	<i>listener</i>	pointer of <a href="#">INatListener</a> object that needs to be removed
----	-----------------	---

**Returns**

Status of deregisterListener success or suitable status code

**4.55.1.16.2.9** `virtual telux::data::OperationType telux::data::net::INatManager::getOperationType ( ) [pure virtual]`

Get the associated operation type for this instance.

**Returns**

OperationType of getOperationType i.e. LOCAL or REMOTE.

**4.55.1.17 class telux::data::net::INatListener**

Interface for Nat listener object. Client needs to implement this interface to get access to Nat services notifications like onServiceStatusChange.

The methods in listener can be invoked from multiple different threads. The implementation should be thread safe.

**Public member functions**

- virtual void [onServiceStatusChange](#) (telux::common::ServiceStatus status)
- virtual [~INatListener](#) ()

**4.55.1.17.1 Constructors and Destructors**

**4.55.1.17.1.1** `virtual telux::data::net::INatListener::~~INatListener ( ) [virtual]`

Destructor for [INatListener](#)

### 4.55.1.17.2 Member Function Documentation

#### 4.55.1.17.2.1 virtual void telux::data::net::INatListener::onServiceStatusChange ( telux::common::ServiceStatus *status* ) [virtual]

This function is called when service status changes.

#### Parameters

in	<i>status</i>	- <a href="#">ServiceStatus</a>
----	---------------	---------------------------------

### 4.55.1.18 class telux::data::net::ISocksManager

SocksManager is a primary interface for configuring legacy Socks proxy server. It also provides interface to Subsystem Restart events by registering as listener. Notifications will be received when modem is ready/not ready.

#### Public member functions

- virtual [telux::common::ServiceStatus](#) getServiceStatus ()=0
- virtual bool isSubsystemReady ()=0
- virtual std::future< bool > onSubsystemReady ()=0
- virtual [telux::common::Status](#) enableSocks (bool enable, [telux::common::ResponseCallback](#) callback=nullptr)=0
- virtual [telux::common::Status](#) registerListener (std::weak\_ptr< [ISocksListener](#) > listener)=0
- virtual [telux::common::Status](#) deregisterListener (std::weak\_ptr< [ISocksListener](#) > listener)=0
- virtual [telux::data::OperationType](#) getOperationType ()=0
- virtual [~ISocksManager](#) ()

### 4.55.1.18.1 Constructors and Destructors

#### 4.55.1.18.1.1 virtual telux::data::net::ISocksManager::~ISocksManager ( ) [virtual]

Destructor for Socks Manager

### 4.55.1.18.2 Member Function Documentation

#### 4.55.1.18.2.1 virtual telux::common::ServiceStatus telux::data::net::ISocksManager::getServiceStatus ( ) [pure virtual]

Checks the status of SocksManager and returns the result.

#### Returns

SERVICE\_AVAILABLE If Socks manager object is ready for service. SERVICE\_UNAVAILABLE

If Socks manager object is temporarily unavailable. SERVICE\_FAILED - If Socks manager object encountered an irrecoverable failure.

#### 4.55.1.18.2.2 **virtual bool telux::data::net::ISocksManager::isSubsystemReady ( ) [pure virtual]**

Checks if the SocksManager subsystem is ready.

##### **Returns**

True if SocksManager is ready for service, otherwise returns false.

##### **Deprecated**

Use getServiceStatus API..

#### 4.55.1.18.2.3 **virtual std::future<bool> telux::data::net::ISocksManager::onSubsystemReady ( ) [pure virtual]**

Wait for SocksManager subsystem to be ready.

##### **Returns**

A future that caller can wait on to be notified when Socksanager is ready.

##### **Deprecated**

Use InitResponseCb callback in factory API getSocksManager.

#### 4.55.1.18.2.4 **virtual telux::common::Status telux::data::net::ISocksManager::enableSocks ( bool *enable*, telux::common::ResponseCallback *callback* = nullptr ) [pure virtual]**

Enable or Disable Socks proxy service.

On platforms with Access control enabled, Caller needs to have TELUX\_DATA\_NETWORK\_CONFIG permission to invoke this API successfully.

##### **Parameters**

in	<i>enable</i>	true: enable proxy, false: disable proxy
in	<i>callback</i>	optional callback to get the operation error code if any

##### **Returns**

Status of proxy enablement i.e. success or suitable status code.

**4.55.1.18.2.5** `virtual telux::common::Status telux::data::net::ISocksManager::registerListener ( std::weak_ptr< ISocksListener > listener ) [pure virtual]`

Register Socks Manager as listener for Data Service health events like data service available or data service not available.

#### Parameters

in	<i>listener</i>	pointer of <a href="#">ISocksListener</a> object that processes the notification
----	-----------------	--

#### Returns

Status of registerListener success or suitable status code

**4.55.1.18.2.6** `virtual telux::common::Status telux::data::net::ISocksManager::deregisterListener ( std::weak_ptr< ISocksListener > listener ) [pure virtual]`

Removes a previously added listener.

#### Parameters

in	<i>listener</i>	pointer of <a href="#">ISocksListener</a> object that needs to be removed
----	-----------------	---

#### Returns

Status of deregisterListener success or suitable status code

**4.55.1.18.2.7** `virtual telux::data::OperationType telux::data::net::ISocksManager::getOperationType ( ) [pure virtual]`

Get the associated operation type for this instance.

#### Returns

OperationType of getOperationType i.e. LOCAL or REMOTE.

### 4.55.1.19 class telux::data::net::ISocksListener

Interface for Socks listener object. Client needs to implement this interface to get access to Socks services notifications like onServiceStatusChange.

The methods in listener can be invoked from multiple different threads. The implementation should be thread safe.

#### Public member functions

- virtual void [onServiceStatusChange](#) ([telux::common::ServiceStatus](#) status)
- virtual [~ISocksListener](#) ()

### 4.55.1.19.1 Constructors and Destructors

4.55.1.19.1.1 `virtual telux::data::net::ISocksListener::~ISocksListener ( ) [virtual]`

Destructor for [ISocksListener](#)

### 4.55.1.19.2 Member Function Documentation

4.55.1.19.2.1 `virtual void telux::data::net::ISocksListener::onServiceStatusChange ( telux::common::ServiceStatus status ) [virtual]`

This function is called when service status changes.

#### Parameters

in	<i>status</i>	- <a href="#">ServiceStatus</a>
----	---------------	---------------------------------

### 4.55.1.20 struct telux::data::net::VlanBindConfig

#### Data fields

Type	Field	Description
int	vlanId	
<a href="#">BackhaulInfo</a>	bhInfo	VLAN ID to be bound to the specified backhaul Configuration of Backhaul to bind VLAN to

### 4.55.1.21 class telux::data::net::IVlanManager

VlanManager is a primary interface for configuring VLAN (Virtual Local Area Network). it provide APIs for create, query, remove VLAN interfaces and associate or disassociate with profile IDs. It also provides interface to Subsystem Restart events by registering as listener. Notifications will be received when modem is ready/not ready.

#### Public member functions

- virtual `telux::common::ServiceStatus getServiceStatus ()=0`
- virtual `bool isSubsystemReady ()=0`
- virtual `std::future< bool > onSubsystemReady ()=0`
- virtual `telux::common::Status createVlan (const VlanConfig &vlanConfig, CreateVlanCb callback=nullptr)=0`
- virtual `telux::common::Status removeVlan (int16_t vlanId, InterfaceType ifaceType, telux::common::ResponseCallback callback=nullptr)=0`
- virtual `telux::common::Status queryVlanInfo (QueryVlanResponseCb callback)=0`
- virtual `telux::common::Status bindToBackhaul (VlanBindConfig vlanBindConfig, telux::common::ResponseCallback callback=nullptr)=0`

- virtual `telux::common::Status unbindFromBackhaul (VlanBindConfig vlanBindConfig, telux::common::ResponseCallback callback=nullptr)=0`
- virtual `telux::common::Status queryVlanToBackhaulBindings (BackhaulType backhaulType, VlanBindingsResponseCb callback, SlotId slotId=DEFAULT_SLOT_ID)=0`
- virtual `telux::common::Status registerListener (std::weak_ptr< IVlanListener > listener)=0`
- virtual `telux::common::Status deregisterListener (std::weak_ptr< IVlanListener > listener)=0`
- virtual `telux::data::OperationType getOperationType ()=0`
- virtual `telux::common::Status bindWithProfile (int profileId, int vlanId, telux::common::ResponseCallback callback=nullptr, SlotId slotId=DEFAULT_SLOT_ID)=0`
- virtual `telux::common::Status unbindFromProfile (int profileId, int vlanId, telux::common::ResponseCallback callback=nullptr, SlotId slotId=DEFAULT_SLOT_ID)=0`
- virtual `telux::common::Status queryVlanMappingList (VlanMappingResponseCb callback, SlotId slotId=DEFAULT_SLOT_ID)=0`
- virtual `~IVlanManager ()`

#### 4.55.1.21.1 Constructors and Destructors

4.55.1.21.1.1 `virtual telux::data::net::IVlanManager::~~IVlanManager ( ) [virtual]`

Destructor for [IVlanManager](#)

#### 4.55.1.21.2 Member Function Documentation

4.55.1.21.2.1 `virtual telux::common::ServiceStatus telux::data::net::IVlanManager::getServiceStatus ( ) [pure virtual]`

Checks the status of VLAN manager and returns the result.

##### Returns

SERVICE\_AVAILABLE If VLAN manager object is ready for service. SERVICE\_UNAVAILABLE If VLAN manager object is temporarily unavailable. SERVICE\_FAILED - If VLAN manager object encountered an irrecoverable failure.

4.55.1.21.2.2 `virtual bool telux::data::net::IVlanManager::isSubsystemReady ( ) [pure virtual]`

Checks if the VLAN manager subsystem is ready.

##### Returns

True if VLAN Manager is ready for service, otherwise returns false.

##### Deprecated

Use getServiceStatus API.

#### 4.55.1.21.2.3 `virtual std::future<bool> telux::data::net::IVlanManager::onSubsystemReady ( )` `[pure virtual]`

Wait for VLAN manager subsystem to be ready.

#### Returns

A future that caller can wait on to be notified when VLAN manager is ready.

#### Deprecated

Use `InitResponseCb` callback in factory API `getVlanManager`.

#### 4.55.1.21.2.4 `virtual telux::common::Status telux::data::net::IVlanManager::createVlan ( const VlanConfig & vlanConfig, CreateVlanCb callback = nullptr )` `[pure virtual]`

Create a VLAN associated with multiple interfaces Creates VLAN on hardware interface `telux::data::InterfaceType`, assigns VLAN id, assigns VLAN priority level (according to IEEE 802.1p priority code point-PCP), and sets whether traffic on this VLAN needs to be accelerated. If platform does not support assigning priorities to VLANs and priority is set to value other than 0, `telux::common::Status::NOTSUPPORTED` is returned. If platform supports Vlan priority, all traffic coming from WWAN or LAN are stamped with priority before sending traffic to tethered client.

On platforms with Access control enabled, Caller needs to have `TELUX_DATA_NETWORK_CONFIG` permission to invoke this API successfully.

#### Note

if interface configured as VLAN for the first time, it may trigger auto reboot.

#### Parameters

in	<code>vlanConfig</code>	VLAN configuration
out	<code>callback</code>	optional callback to get the response <code>createVlan</code>

#### Returns

Immediate status of `createVlan()` request sent i.e. success or suitable status code.

#### 4.55.1.21.2.5 `virtual telux::common::Status telux::data::net::IVlanManager::removeVlan ( int16_t vlanId, InterfaceType ifaceType, telux::common::ResponseCallback callback = nullptr )` `[pure virtual]`

Remove VLAN configuration

On platforms with Access control enabled, Caller needs to have `TELUX_DATA_NETWORK_CONFIG` permission to invoke this API successfully.

#### Note

This will delete all clients associated with interface

**Parameters**

in	<i>vlanId</i>	VLAN ID
in	<i>ifaceType</i>	<a href="#">telux::data::InterfaceType</a>
out	<i>callback</i>	optional callback to get the response removeVlan

**Returns**

Immediate status of [removeVlan\(\)](#) request sent i.e. success or suitable status code.

#### 4.55.1.21.2.6 virtual [telux::common::Status telux::data::net::IVlanManager::queryVlanInfo \( QueryVlanResponseCb callback \) \[pure virtual\]](#)

Query information about all the VLANs in the system

**Parameters**

out	<i>callback</i>	Response callback with list of configured VLANs
-----	-----------------	---

**Returns**

Immediate status of [queryVlanInfo\(\)](#) request sent i.e. success or suitable status code.

#### 4.55.1.21.2.7 virtual [telux::common::Status telux::data::net::IVlanManager::bindToBackhaul \( VlanBindConfig vlanBindConfig, telux::common::ResponseCallback callback = nullptr \) \[pure virtual\]](#)

Bind a VLAN with a particular profile id. When a WWAN network interface is brought up using [IDataConnectionManager::startDataCall](#) on that profile id, that interface will be accessible from this VLAN. The behavior of this API is dependent on platform/system configuration. If the platform is configured to allow multiple VLANs to be bound to the same profile id then:

- Binding multiple VLANs to any profile id can be achieved by calling this API with each VLAN id. Each VLAN will be associated with it's own bridge.
- Reboot is not triggered with any bind operation. If the platform is not configured to allow multiple VLANs to be bound to the same profile id then:
- Binding VLAN to default profile id will associate it with bridge0 and trigger automatic reboot.
- Binding VLAN to any other profile id will associate it with own bridge.
- Multiple VLAN binding attempt to any profile id will result in error [telux::common::ErrorCode::INVALID\\_OPERATION](#) This setting will be persistent across multiple boots.

**Parameters**

in	<i>vlanBindConfig</i>	Backhaul information and vlan id to bind it to. <a href="#">telux::data::net::VlanBindConfig</a>
out	<i>callback</i>	Callback to get the response of bindToBackhaul API



**Returns**

Immediate status of [bindToBackhaul\(\)](#) request sent i.e. success or suitable status code.

**Note**

Eval: This is a new API and is being evaluated. It is subject to change and could break backwards compatibility.

**4.55.1.21.2.8** `virtual telx::common::Status telx::data::net::VlanManager::unbindFromBackhaul ( VlanBindConfig vlanBindConfig, telx::common::ResponseCallback callback = nullptr ) [pure virtual]`

Unbind VLAN from particular backhaul. This API will stop vlan traffic flow to/from specified backhaul type. Slot ID and profile ID are relevant only for WWAN backhaul. For all other backhauls types, values are don't care.

**Parameters**

in	<i>vlanBindConfig</i>	Backhaul information and vlan id to unbind it from. <a href="#">telx::data::net::VlanBindConfig</a>
in	<i>callback</i>	Callback to get the response of unbindFromBackhaul API

**Returns**

Immediate status of [unbindFromBackhaul\(\)](#) request sent i.e. success or suitable status code

**Note**

Eval: This is a new API and is being evaluated. It is subject to change and could break backwards compatibility.

**4.55.1.21.2.9** `virtual telx::common::Status telx::data::net::VlanManager::queryVlanToBackhaul(← Bindings ( BackhaulType backhaulType, VlanBindingsResponseCb callback, SlotId slotId = DEFAULT_SLOT_ID ) [pure virtual]`

Query VLAN to backhaul binding configurations

**Parameters**

in	<i>backhaulType</i>	Backhaul to query vlan binding for.
in	<i>callback</i>	callback to get the response of queryVlanToBackhaulBindings API
in	<i>slotId</i>	Specify slot id which has the sim that contains profile id mapping to VLAN id.

**Returns**

Immediate status of [queryVlanToBackhaulBindings\(\)](#) request sent i.e. success or suitable status code

**Note**

Eval: This is a new API and is being evaluated. It is subject to change and could break backwards compatibility.

#### 4.55.1.21.2.10 virtual telux::common::Status telux::data::net::IVlanManager::registerListener ( std::weak\_ptr< IVlanListener > *listener* ) [pure virtual]

Register VLAN Manager as a listener for Data Service health events like data service available or data service not available.

**Parameters**

in	<i>listener</i>	pointer of <a href="#">IVlanListener</a> object that processes the notification
----	-----------------	---

**Returns**

Status of registerListener success or suitable status code

#### 4.55.1.21.2.11 virtual telux::common::Status telux::data::net::IVlanManager::deregisterListener ( std::weak\_ptr< IVlanListener > *listener* ) [pure virtual]

Removes a previously added listener.

**Parameters**

in	<i>listener</i>	pointer of <a href="#">IVlanListener</a> object that needs to be removed
----	-----------------	--

**Returns**

Status of deregisterListener success or suitable status code

#### 4.55.1.21.2.12 virtual telux::data::OperationType telux::data::net::IVlanManager::getOperationType ( ) [pure virtual]

Get the associated operation type for this instance.

**Returns**

OperationType of getOperationType i.e. LOCAL or REMOTE.

#### 4.55.1.21.2.13 virtual telux::common::Status telux::data::net::IVlanManager::bindWithProfile ( int *profileId*, int *vlanId*, telux::common::ResponseCallback *callback* = nullptr, SlotId *slotId* = DEFAULT\_SLOT\_ID ) [pure virtual]

Bind a VLAN with a particular profile id and slot id. When a WWAN network interface is brought up using [IDataConnectionManager::startDataCall](#) on that profile id and slot id, that interface will be accessible from this VLAN. The behavior of this API is dependent on platform/system configuration. If the platform is configured to allow multiple VLANs to be bound to the same profile id - slot id pair then:

- Binding multiple VLANs to any profile id - slot id pair can be achieved by calling this API with each VLAN id. Each VLAN will be associated with it's own bridge.
- Reboot is not triggered with any bind operation. If the platform is not configured to allow multiple VLANs to be bound to the same profile id - slot id pair then:
- Binding VLAN to default profile id and slot id will associate it with bridge0 and trigger automatic reboot.
- Binding VLAN to any other profile id and slot id will associate it with own bridge.
- Multiple VLAN binding attempt to any profile id or slot id will result in error `telux::common::ErrorCode::INVALID_OPERATION` This setting will be persistent across multiple boots.

### Parameters

in	<i>profileId</i>	profile id for VLAN association
in	<i>vlanId</i>	VLAN ID to be bound to the data call brought up on the profile id
out	<i>callback</i>	callback to get the response of associateWithProfileId API
in	<i>slotId</i>	Specify slot id which has the sim that contains profile id.

### Returns

Immediate status of associateWithProfileId() request sent i.e. success or suitable status code.

### Deprecated

Use [bindToBackhaul\(\)](#) API below to bind VLAN to backhaul

**4.55.1.21.2.14** `virtual telux::common::Status telux::data::net::IVlanManager::unbindFromProfile ( int profileId, int vlanId, telux::common::ResponseCallback callback = nullptr, SlotId slotId = DEFAULT_SLOT_ID ) [pure virtual]`

Unbind VLAN id from given slot id and profile id This setting will be persistent across multiple boots.

### Parameters

in	<i>profileId</i>	profile id for VLAN association
in	<i>vlanId</i>	VLAN ID to be unbound to the data call brought up on the profile id
in	<i>callback</i>	callback to get the response of associateWithProfileId API
in	<i>slotId</i>	Specify slot id which has the sim that contains profile id .

### Returns

Immediate status of disassociateFromProfileId() request sent i.e. success or suitable status code

### Deprecated

Use [unbindFromBackhaul\(\)](#) API below to unbind VLAN to backhaul

**4.55.1.21.2.15** `virtual telux::common::Status telux::data::net::IVlanManager::queryVlanMappingList ( VlanMappingResponseCb callback, SlotId slotId = DEFAULT_SLOT_ID ) [pure virtual]`

Query VLAN mapping of profile id and VLAN id on specified sim

#### Parameters

in	<i>callback</i>	callback to get the response of queryVlanMappingList API
in	<i>slotId</i>	Specify slot id which has the sim that contains profile id mapping to VLAN id.

#### Returns

Immediate status of [queryVlanMappingList\(\)](#) request sent i.e. success or suitable status code

#### Deprecated

Use [queryVlanToBackhaulBindings\(\)](#) API below to request VLAN to backhaul mapping

### 4.55.1.22 class telux::data::net::IVlanListener

Interface for VLAN listener object. Client needs to implement this interface to get access to Socks services notifications like onServiceStatusChange.

The methods in listener can be invoked from multiple different threads. The implementation should be thread safe.

#### Public member functions

- virtual void [onServiceStatusChange](#) (telux::common::ServiceStatus status)
- virtual void [onHwAccelerationChanged](#) (const ServiceState state)
- virtual [~IVlanListener](#) ()

#### 4.55.1.22.1 Constructors and Destructors

**4.55.1.22.1.1** `virtual telux::data::net::IVlanListener::~~IVlanListener ( ) [virtual]`

Destructor for [IVlanListener](#)

#### 4.55.1.22.2 Member Function Documentation

**4.55.1.22.2.1** `virtual void telux::data::net::IVlanListener::onServiceStatusChange ( telux::common::↔ ServiceStatus status ) [virtual]`

This function is called when service status changes.

**Parameters**

in	<i>status</i>	- <a href="#">ServiceStatus</a>
----	---------------	---------------------------------

#### 4.55.1.22.2.2 virtual void telux::data::net::IVlanListener::onHwAccelerationChanged ( const ServiceState *state* ) [virtual]

This function is called when there is a change in IPA Connection Manager daemon state.

**Parameters**

in	<i>state</i>	New state of IPA connection Manager daemon Active/Inactive
----	--------------	--

**Note**

This is global state

## 4.55.2 Enumeration Type Documentation

### 4.55.2.1 enum telux::data::net::BridgeIFaceType [strong]

Interface types supported for bridge configuration

**Enumerator**

**UNKNOWN**

**WLAN\_AP** Wireless Local Area Network (WLAN) in AP mode

**WLAN\_STA** Wireless Local Area Network (WLAN) in STA mode

**ETH** Ethernet (ETH)

### 4.55.2.2 enum telux::data::net::L2tpProtocol [strong]

L2TP encapsulation protocols

**Enumerator**

**NONE**

**IP** IP Protocol used for encapsulation

**UDP** UDP Protocol used for encapsulation

## 4.56 Cellular V2X

- [C APIs](#)
- [C++ APIs](#)

This section contains APIs related to Cellular-V2X operation. The SDK has C and C++ APIs. The C APIs are legacy and are being maintained for backwards compatibility purposes. These APIs are mostly wrappers over the C++ APIs. New features and functionality will be added to C++ APIs. For anyone writing new Cv2x software, it is recommended to use the C++ APIs.

# 5 Namespace Documentation

---

## 5.1 telux Namespace Reference

DeviceConfig provides utility functions to get device configuration details such as multi SIM support.

### Namespaces

- [audio](#)
- [common](#)
- [config](#)
- [cv2x](#)
- [data](#)
- [loc](#)
- [platform](#)
- [power](#)
- [sec](#)
- [sensor](#)
- [tel](#)
- [therm](#)
- [wlan](#)

DeviceConfig provides utility functions to get device configuration details such as multi SIM support.

Cv2x Rx packets helper class - Help to parse the received packets' meta data at the beginning of the payload, any applications that have enabled the received packets' meta data should use this helper class before using the real payload.

## 5.2 telux::audio Namespace Reference

### Data Structures

- struct [AmrwbpParams](#)
- class [AudioFactory](#)
- struct [ChannelVolume](#)

- struct [DtmfTone](#)
- struct [FormatInfo](#)
- struct [FormatParams](#)
- class [IAudioBuffer](#)
- class [IAudioCaptureStream](#)
- class [IAudioDevice](#)
- class [IAudioListener](#)
- class [IAudioLoopbackStream](#)
- class [IAudioManager](#)
- class [IAudioPlayStream](#)
- class [IAudioStream](#)
- class [IAudioToneGeneratorStream](#)
- class [IAudioVoiceStream](#)
- class [IPlayListener](#)
- class [IStreamBuffer](#)
- class [ITranscodeListener](#)
- class [ITranscoder](#)
- class [IVoiceListener](#)
- struct [StreamConfig](#)
- struct [StreamMute](#)
- struct [StreamVolume](#)

## 5.2.1 Variable Documentation

### 5.2.1.1 `const uint16_t telux::audio::INFINITE_DTMF_DURATION = 0xFFFF`

Specifies that the DTMF tone should be played indefinitely

### 5.2.1.2 `const uint16_t telux::audio::INFINITE_TONE_DURATION = 0xFFFF`

Specifies that the audio tone should be played indefinitely

## 5.3 `telux::common` Namespace Reference

### Data Structures

- class [DeviceConfig](#)
- class [ICommandCallback](#)



- class [ICommandResponseCallback](#)

*General command response callback for most of the requests, client needs to implement this interface to get single shot response. [More...](#)*

- class [IServiceStatusListener](#)
- class [Log](#)
- struct [SdkVersion](#)
- class [Version](#)

*Provides version of SDK. [More...](#)*

## 5.3.1 Typedef Documentation

### 5.3.1.1 using `telux::common::ResponseCallback = typedef std::function<void(telux::common::ErrorCode errorCode)>`

General response callback for most of the requests, client needs to implement this function to get the asynchronous response.

The methods in callback can be invoked from multiple different threads. The implementation should be thread safe.

#### Parameters

in	<code>errorCode</code>	<a href="#">ErrorCode</a>
----	------------------------	---------------------------

### 5.3.1.2 using `telux::common::InitResponseCb = typedef std::function<void(telux::common::ServiceStatus status)>`

This API is invoked when the initialization of an object completes.

#### Parameters

in	<code>status</code>	- <a href="#">ServiceStatus</a>
----	---------------------	---------------------------------

## 5.4 telux::config Namespace Reference

### Data Structures

- class [ConfigFactory](#)

*[ConfigFactory](#) allows creation of config related classes. [More...](#)*

- struct [ConfigInfo](#)
- class [IConfigListener](#)

*[IConfigListener](#) interface is used to receive notifications related to any updates in the configurations dynamically. [More...](#)*

- class [IConfigManager](#)

*IConfigManager* provides APIs to retrieve an instance of the manager, APIs for processes to update and retrieve configurations dynamically. [More...](#)

- class [IModemConfigListener](#)

*Listener class for getting notifications related to configuration change detection. The client needs to implement these methods as briefly as possible and avoid blocking calls in it. The methods in this class can be invoked from multiple different threads. Client needs to make sure that the implementation is thread-safe.* [More...](#)

- class [IModemConfigManager](#)

*IModemConfigManager* provides interface to list config files present in modem's storage. load a new config file in modem, activate a config file, get active config file information, deactivate a config file, delete config file from the modem's storage, get and set mode of config auto selection, register and deregister listener for config update in modem. The config files are also referred to as MBNs. [More...](#)

## 5.5 telux::cv2x Namespace Reference

### Namespaces

- [prop](#)

### Data Structures

- struct [ConfigEventInfo](#)
- class [Cv2xFactory](#)

*Cv2xFactory* is the factory that creates the Cv2x Radio. [More...](#)
- struct [Cv2xPoolStatus](#)
- struct [Cv2xRadioCapabilities](#)
- class [Cv2xRxMetaDataHelper](#)
- struct [Cv2xStatus](#)
- struct [Cv2xStatusEx](#)
- class [Cv2xUtil](#)
- struct [DataSessionSettings](#)
- struct [EventFlowInfo](#)
- struct [GlobalIPUnicastRoutingInfo](#)
- class [ICv2xConfig](#)

*Cv2xConfig* provide operations to update or request cv2x configuration. [More...](#)
- class [ICv2xConfigListener](#)

*Listeners for ICv2xConfig* must implement this interface. [More...](#)
- class [ICv2xListener](#)

*Cv2x Radio Manager* listeners implement this interface.

- class [ICv2xRadio](#)
- class [ICv2xRadioListener](#)  
*Listeners for Cv2xRadio must implement this interface. [More...](#)*
- class [ICv2xRadioManager](#)  
*Cv2xRadioManager manages instances of Cv2xRadio. [More...](#)*
- class [ICv2xRxSubscription](#)
- class [ICv2xThrottleManager](#)  
*ThrottleManager provides throttle manager client interface. [More...](#)*
- class [ICv2xThrottleManagerListener](#)  
*Listener class for getting filter rate update notification. [More...](#)*
- class [ICv2xTxFlow](#)
- class [ICv2xTxRxSocket](#)
- class [ICv2xTxStatusReportListener](#)  
*Listeners for CV2X Tx status report must implement this interface. [More...](#)*
- struct [IPv6Address](#)
- struct [IPv6AddrType](#)
- struct [L2FilterInfo](#)
- struct [MacDetails](#)
- struct [RFTxInfo](#)
- struct [RxPacketMetaDataReport](#)
- struct [SlssRxInfo](#)
- struct [SocketInfo](#)
- struct [SpsFlowInfo](#)
- struct [SpsSchedulingInfo](#)
- struct [SyncRefUeInfo](#)
- struct [TrustedUEInfo](#)
- struct [TrustedUEInfoList](#)
- struct [TxPoolIdInfo](#)
- struct [TxStatusReport](#)

## 5.5.1 Typedef Documentation

**5.5.1.1 using telux::cv2x::CreateRxSubscriptionCallback = typedef std::function<void (std::shared\_ptr<ICv2xRxSubscription> rxSub, telux::common::ErrorCode error)>**

This function is called as a response to [ICv2xRadio::createRxSubscription](#).

#### Parameters

in	<i>rxSub</i>	- Rx Subscription
in	<i>error</i>	- Indicates whether socket creation succeeded <ul style="list-style-type: none"> <li>• SUCCESS</li> <li>• GENERIC_FAILURE</li> </ul>

**5.5.1.2 using telux::cv2x::CreateTxSpsFlowCallback = typedef std::function<void (std::shared\_ptr<ICv2xTxFlow> txSpsFlow, std::shared\_ptr<ICv2xTxFlow> txEventFlow, telux::common::ErrorCode spsError, telux::common::ErrorCode eventError)>**

This function is called as a response to [ICv2xRadio::createTxSpsFlow](#)

#### Parameters

in	<i>txSpsFlow</i>	- Sps flow
in	<i>txEventFlow</i>	- Optional event flow. Will be nullptr if event flow was not specified in the request
in	<i>spsError</i>	- Indicates whether Tx SPS flow creation succeeded <ul style="list-style-type: none"> <li>• SUCCESS</li> <li>• GENERIC_FAILURE</li> </ul>
in	<i>eventError</i>	- Indicates whether optional Tx Event flow creation succeeded <ul style="list-style-type: none"> <li>• SUCCESS</li> <li>• GENERIC_FAILURE</li> </ul>

**5.5.1.3 using telux::cv2x::CreateTxEventFlowCallback = typedef std::function<void (std::shared\_ptr<ICv2xTxFlow> txEventFlow, telux::common::ErrorCode error)>**

This function is called with the response to [ICv2xRadio::createTxEventFlow](#)

#### Parameters

in	<i>txEventFlow</i>	- Event flow
in	<i>error</i>	- Indicates whether Tx event flow creation succeeded <ul style="list-style-type: none"> <li>• SUCCESS</li> <li>• GENERIC_FAILURE</li> </ul>

### 5.5.1.4 using telux::cv2x::CloseTxFlowCallback = typedef std::function<void (std::shared\_ptr<ICv2xTxFlow> txFlow, telux::common::ErrorCode error)>

This function is called with the response to [ICv2xRadio::closeTxFlow](#).

#### Parameters

in	<i>txFlow</i>	- Closed tx flow
in	<i>error</i>	- Indicates whether close operation succeeded <ul style="list-style-type: none"> <li>• SUCCESS</li> <li>• GENERIC_FAILURE</li> </ul>

### 5.5.1.5 using telux::cv2x::CloseRxSubscriptionCallback = typedef std::function<void (std::shared\_ptr<ICv2xRxSubscription> rxSub, telux::common::ErrorCode error)>

This function is called with the response to [ICv2xRadio::closeRxSubscription](#).

#### Parameters

in	<i>rxSub</i>	- Closed rx subscription
in	<i>error</i>	- Indicates whether Rx subscription close succeeded <ul style="list-style-type: none"> <li>• SUCCESS</li> <li>• GENERIC_FAILURE</li> </ul>

### 5.5.1.6 using telux::cv2x::ChangeSpsFlowInfoCallback = typedef std::function<void (std::shared\_ptr<ICv2xTxFlow> txFlow, telux::common::ErrorCode error)>

This function is called with the response to [ICv2xRadio::changeSpsFlowInfo](#).

#### Parameters

in	<i>txFlow</i>	- Sps flow that requested reservation change
in	<i>error</i>	- SUCCESS if Tx reservation change succeeded <ul style="list-style-type: none"> <li>• SUCCESS</li> <li>• GENERIC_FAILURE</li> </ul>

### 5.5.1.7 using telux::cv2x::RequestSpsFlowInfoCallback = typedef std::function<void (std::shared\_ptr<ICv2xTxFlow> txFlow, const SpsFlowInfo & spsInfo, telux::common::ErrorCode error)>

This function is called with the response to [ICv2xRadio::requestSpsFlowInfo](#).

**Parameters**

in	<i>txFlow</i>	- SPS flow that requested info
in	<i>spsInfo</i>	- SPS flow reservation info
in	<i>error</i>	- SUCCESS if Tx reservation change succeeded • SUCCESS • GENERIC_FAILURE

### 5.5.1.8 using `telux::cv2x::ChangeEventFlowInfoCallback = typedef std::function<void (std::shared_ptr<ICv2xTxFlow> txFlow, telux::common::ErrorCode error)>`

This function is called with the response to [ICv2xRadio::changeEventFlowInfo](#).

**Parameters**

in	<i>txFlow</i>	- Event flow that requested reservation change
in	<i>error</i>	- SUCCESS if Tx parameter change succeeded • SUCCESS • GENERIC_FAILURE

### 5.5.1.9 using `telux::cv2x::RequestCapabilitiesCallback = typedef std::function<void(const Cv2xRadioCapabilities & capabilities, telux::common::ErrorCode error)>`

This function is called with the response to [ICv2xRadio::requestCapabilities](#).

**Parameters**

in	<i>capabilities</i>	- Capability info
in	<i>error</i>	- SUCCESS if capabilities request succeeded • SUCCESS • GENERIC_FAILURE

### 5.5.1.10 using `telux::cv2x::RequestDataSessionSettingsCallback = typedef std::function<void (const DataSessionSettings & settings, telux::common::← ErrorCode error)>`

This function is called with the response to [ICv2xRadio::requestDataSessionSettings](#).

**Parameters**

in	<i>settings</i>	- Data session settings
in	<i>error</i>	- SUCCESS if data session settings request succeeded • SUCCESS • GENERIC_FAILURE

### 5.5.1.11 using telux::cv2x::UpdateTrustedUEListCallback = typedef std::function<void(telux::common::ErrorCode error)>

This function is called with the response to [ICv2xRadio::updateTrustedUEList](#).

#### Parameters

in	<i>error</i>	<ul style="list-style-type: none"> <li>- SUCCESS if update succeeded</li> <li>• INVALID_ARGUMENTS if trustedUEs or maliciousIds length greater than maximum value</li> <li>• SUCCESS</li> <li>• GENERIC_FAILURE</li> <li>• INVALID_ARGUMENTS</li> </ul>
----	--------------	---

### 5.5.1.12 using telux::cv2x::UpdateSrcL2InfoCallback = typedef std::function<void(telux::common::ErrorCode error)>

This function is called with the response to [ICv2xRadio::updateSrcL2Info](#).

#### Parameters

in	<i>error</i>	<ul style="list-style-type: none"> <li>- SUCCESS if Tx reservation change succeeded</li> <li>• SUCCESS</li> <li>• GENERIC_FAILURE</li> </ul>
----	--------------	--

### 5.5.1.13 using telux::cv2x::CreateTcpSocketCallback = typedef std::function<void(std::shared\_ptr<ICv2xTxRxSocket> sock, telux::common::ErrorCode error)>

This function is called with the response to [ICv2xRadio::createCv2xTcpSocket](#).

#### Parameters

in	<i>sock</i>	- TCP socket
in	<i>error</i>	<ul style="list-style-type: none"> <li>- Indicates whether TCP socket creation succeeded</li> <li>• SUCCESS</li> <li>• GENERIC_FAILUREs</li> </ul>

### 5.5.1.14 using telux::cv2x::CloseTcpSocketCallback = typedef std::function<void(std::shared\_ptr<ICv2xTxRxSocket> sock, telux::common::ErrorCode error)>

This function is called with the response to [ICv2xRadio::closeCv2xTcpSocket](#).

**Parameters**

in	<i>sock</i>	- Closed TCP socket
in	<i>error</i>	- Indicates whether close operation succeeded <ul style="list-style-type: none"> <li>• SUCCESS</li> <li>• GENERIC_FAILURE</li> </ul>

### 5.5.1.15 using `telux::cv2x::StartCv2xCallback = typedef std::function<void (telux::common::ErrorCode error)>`

This function is called as a response to [ICv2xRadioManager::startCv2x](#)

**Parameters**

in	<i>error</i>	- SUCCESS if Cv2x mode successfully started <ul style="list-style-type: none"> <li>• SUCCESS</li> <li>• GENERIC_FAILURE</li> </ul>
----	--------------	---

### 5.5.1.16 using `telux::cv2x::StopCv2xCallback = typedef std::function<void (telux::common::ErrorCode error)>`

This function is called as a response to [ICv2xRadioManager::stopCv2x](#)

**Parameters**

in	<i>error</i>	- SUCCESS if Cv2x mode successfully stopped <ul style="list-style-type: none"> <li>• SUCCESS</li> <li>• GENERIC_FAILURE</li> </ul>
----	--------------	---

### 5.5.1.17 using `telux::cv2x::RequestCv2xStatusCallback = typedef std::function<void (Cv2xStatus status, telux::common::ErrorCode error)>`

This function is called as a response to [ICv2xRadioManager::requestCv2xStatus](#)

**Parameters**

in	<i>status</i>	- Cv2x status
in	<i>error</i>	- SUCCESS if Cv2x status was successfully retrieved <ul style="list-style-type: none"> <li>• SUCCESS</li> <li>• GENERIC_FAILURE</li> </ul>

**Deprecated**

use [RequestCv2xStatusCallbackEx](#)



**5.5.1.18** `using telux::cv2x::RequestCv2xStatusCallbackEx = typedef std::function<void (Cv2xStatusEx status, telux::common::ErrorCode error)>`

This function is called as a response to [ICv2xRadioManager::requestCv2xStatus](#)

#### Parameters

in	<i>status</i>	- Cv2x status
in	<i>error</i>	- SUCCESS if Cv2x status was successfully retrieved • SUCCESS • GENERIC_FAILURE

**5.5.1.19** `using telux::cv2x::UpdateConfigurationCallback = typedef std::function<void (telux::common::ErrorCode error)>`

This function is called with the response to [ICv2xRadioManager::updateConfiguration](#)

#### Parameters

in	<i>error</i>	- SUCCESS if configuration was updated successfully • SUCCESS • GENERIC_FAILURE
----	--------------	---

**5.5.1.20** `using telux::cv2x::GetSlssRxInfoCallback = typedef std::function<void (const SlssRxInfo& info, telux::common::ErrorCode error)>`

This function is called as a response to [ICv2xRadioManager::getCv2xSlssRxInfo](#)

#### Parameters

out	<i>info</i>	- Cv2x SLSS Rx Information
out	<i>error</i>	- SUCCESS if Cv2x SLSS Rx Information was successfully retrieved • SUCCESS • GENERIC_FAILURE

## 5.6 telux::cv2x::prop Namespace Reference

## Data Structures

- struct [CBPConfig](#)
- struct [ChannelData](#)
- struct [CongestionControlCalculations](#)
- struct [CongestionControlConfig](#)
- struct [CongestionControlData](#)
- struct [CongestionControlUserData](#)
- class [CongestionControlUtil](#)
- class [CongestionControlUtility](#)  
*Utility class for congestion control logging and testing purposes. [More...](#)*
- struct [CQIConfig](#)
- struct [DensityConfig](#)
- class [ICongestionControlListener](#)  
*Congestion Control listeners implement this interface. [More...](#)*
- class [ICongestionControlManager](#)  
*CongestionControl Manager is a primary interface for CongestionControl related functionality. [More...](#)*
- struct [ITTConfig](#)
- struct [PERConfig](#)
- struct [PERInterData](#)
- struct [Position](#)
- struct [PowerConfig](#)
- struct [SPSEnhanceConfig](#)
- struct [SpsEnhanceData](#)
- struct [SubPERInterData](#)
- struct [TEConfig](#)
- struct [TrackingErrorData](#)
- class [V2xPropFactory](#)  
*V2xPropFactory allows creation of [ICongestionControlManager](#). [More...](#)*

## 5.7 telux::data Namespace Reference

### Namespaces

- [net](#)

## Data Structures

- struct [BackhaulInfo](#)
- struct [BandInterferenceConfig](#)
- struct [BitRateInfo](#)
- struct [DataCallEndReason](#)
- union [DataCallEndReason.\\_\\_unnamed\\_\\_](#)
- struct [DataCallStats](#)
- class [DataFactory](#)

*DataFactory is the central factory to create all data classes. [More...](#)*
- class [DataProfile](#)

*DataProfile class represents single data profile on the modem. [More...](#)*
- struct [DataRestrictMode](#)
- struct [DataUsage](#)
- struct [DdsInfo](#)
- struct [DeviceDataUsage](#)
- struct [EspInfo](#)
- struct [EthCapability](#)
- struct [FlowDataRate](#)
- class [IClientListener](#)
- class [IClientManager](#)

*Client Manager class provides APIs related to devices and clients connected to MDM via different interconnects. A device is any entity with a unique MAC address that is connected to the MDM and clients are characterized by unique IP address. Clients could also be connected over VLANs. Interconnects can be wired (e.g. Ethernet) or wireless (e.g. WLAN). [More...](#)*
- struct [IcmpInfo](#)
- class [IDataCall](#)

*Represents single established data call on the device. [More...](#)*
- class [IDataConnectionListener](#)
- class [IDataConnectionManager](#)

*IDataConnectionManager is a primary interface for cellular connectivity This interface provides APIs for start and stop data call connections, get data call information and listener for monitoring data calls. It also provides interface to Subsystem Restart events by registering as listener. Notifications will be received when modem is ready/not ready. [More...](#)*
- class [IDataCreateProfileCallback](#)
- class [IDataFilterListener](#)

*Listener class for listening to filtering mode notifications, like Data filtering mode change. Client need to*

implement these methods. The methods in listener can be invoked from multiple threads. So the client needs to make sure that the implementation is thread-safe. [More...](#)

- class [IDataFilterManager](#)

*[IDataFilterManager](#) class provides interface to enable/disable the data restrict filters and register for data restrict filter. The filtering can be done at any time. One such use case is to do it when we want the AP to suspend so that we are not waking up the AP due to spurious incoming messages. Also to make sure the DataRestrict mode is enabled. [More...](#)*

- class [IDataLinkListener](#)

- class [IDataLinkManager](#)

*The Data Link Manager class provides APIs related to data communication links, for example, APIs to update the Ethernet link operating mode. [More...](#)*

- class [IDataProfileCallback](#)

- class [IDataProfileListCallback](#)

*Interface for getting list of [DataProfile](#) using callback. Client needs to implement this interface to get single shot responses for commands like get profile list and query profile. [More...](#)*

- class [IDataProfileListener](#)

*Listener class for getting profile change notification. [More...](#)*

- class [IDataProfileManager](#)

- class [IDataSettingsListener](#)

- class [IDataSettingsManager](#)

*Data Settings Manager class provides APIs related to the data subsystem settings. For example, ability to reset current network settings to factory settings, setting backhaul priority, and enabling roaming per PDN. [More...](#)*

- class [IEspFilter](#)

*This class represents a IP Filter for the ESP, get the new instance from [telux::data::DataFactory](#). [More...](#)*

- class [IcmpFilter](#)

*This class represents a IP Filter for the ICMP, get the new instance from [telux::data::DataFactory](#). [More...](#)*

- class [IipFilter](#)

*A IP filter class to add specific filters like what data will be allowed from the modem to the application processor. Only data packets that match the filter will be sent to the apps processor. Also used to configure Firewall rules. [More...](#)*

- struct [IpAddrInfo](#)

- struct [IpFamilyInfo](#)

- struct [IPv4Info](#)

- struct [IPv6Info](#)

- class [IServingSystemListener](#)

*Listener class for data serving system change notification. [More...](#)*

- class [IServingSystemManager](#)

*Serving System Manager class provides APIs related to the serving system for data functionality. For example, ability to query or be notified about the state of the platform's WWAN PS data serving information. [More...](#)*

- class [ITcpFilter](#)

*This class represents a IP Filter for the TCP, get the new instance from [telux::data::DataFactory](#). [More...](#)*

- class [IUdpFilter](#)

*This class represents a IP Filter for the UDP, get the new instance from [telux::data::DataFactory](#). [More...](#)*

- struct [PortInfo](#)
- struct [ProfileParams](#)
- struct [QosFilterRule](#)
- struct [QosIPFlowInfo](#)
- struct [RoamingStatus](#)

*Roaming Status. [More...](#)*

- struct [ServiceStatus](#)

*Data Service Status Info. [More...](#)*

- struct [TcpInfo](#)
- struct [TftChangeInfo](#)
- struct [TrafficFlowTemplate](#)
- struct [UdpInfo](#)
- struct [VlanConfig](#)

## 5.8 telux::data::net Namespace Reference

### Data Structures

- struct [BridgeInfo](#)
- struct [DmzConfig](#)
- struct [FirewallConfig](#)
- struct [FirewallEntryInfo](#)
- class [IBridgeListener](#)
- class [IBridgeManager](#)

*[IBridgeManager](#) provides APIs to enable/disable and set/get/delete software bridges for various WLAN and Ethernet interfaces. It also provides interface to Subsystem Restart events by registering as listener. Notifications will be received when modem is ready/not ready. [More...](#)*

- class [IFirewallEntry](#)

*Firewall entry class is used for configuring firewall rules. [More...](#)*

- class [IFirewallListener](#)

- class [IFirewallManager](#)

*FirewallManager is a primary interface that filters and controls the network traffic on a pre-configured set of rules. It also provides interface to Subsystem Restart events by registering as listener. Notifications will be received when modem is ready/not ready. [More...](#)*

- class [IL2tpListener](#)
- class [IL2tpManager](#)

*L2tpManager is a primary interface for configuring L2TP Service. It also provides interface to Subsystem Restart events by registering as listener. Notifications will be received when modem is ready/not ready. [More...](#)*

- class [INatListener](#)
- class [INatManager](#)

*NatManager is a primary interface for configuring static network address translation(SNAT) and DMZ (demilitarized zone). It also provides interface to Subsystem Restart events by registering as listener. Notifications will be received when modem is ready/not ready. [More...](#)*

- class [ISocksListener](#)
- class [ISocksManager](#)

*SocksManager is a primary interface for configuring legacy Socks proxy server. It also provides interface to Subsystem Restart events by registering as listener. Notifications will be received when modem is ready/not ready. [More...](#)*

- class [IVlanListener](#)
- class [IVlanManager](#)

*VlanManager is a primary interface for configuring VLAN (Virtual Local Area Network). it provide APIs for create, query, remove VLAN interfaces and associate or disassociate with profile IDs. It also provides interface to Subsystem Restart events by registering as listener. Notifications will be received when modem is ready/not ready. [More...](#)*

- struct [L2tpSessionConfig](#)
- struct [L2tpSysConfig](#)
- struct [L2tpTunnelConfig](#)
- struct [NatConfig](#)
- struct [VlanBindConfig](#)

## 5.9 telux::loc Namespace Reference

## Data Structures

- struct [BodyToSensorMountParams](#)
- struct [DREngineConfiguration](#)
- struct [GlonassTimeInfo](#)
- struct [GnssData](#)
- struct [GnssDisasterCrisisReport](#)
- struct [GnssEnergyConsumedInfo](#)
- struct [GnssKinematicsData](#)
- struct [GnssMeasurementInfo](#)
- struct [GnssMeasurements](#)
- struct [GnssMeasurementsClock](#)
- struct [GnssMeasurementsData](#)
- class [IDgnssManager](#)

*IDgnssManager* provides interface to inject RTCM data into modem, register event listener reported by cdfw(correction data framework). [More...](#)

- class [IDgnssStatusListener](#)

*IDgnssStatusListener* listener class for getting RTCM injection event notification information. [More...](#)

- class [IGnssSignalInfo](#)

*IGnssSignalInfo* provides interface to retrieve GNSS data information like jammer metrics and automatic gain control for satellite signal type. [More...](#)

- class [IGnssSVInfo](#)

*IGnssSVInfo* provides interface to retrieve the list of SV info available and whether altitude is assumed or calculated. [More...](#)

- class [ILocationConfigListener](#)

*ILocationConfigListener* interface is used to receive notifications related to configuration events. [More...](#)

- class [ILocationConfigurator](#)

*ILocationConfigurator* allows general engine configurations (example: TUNC, PACE etc), configuration of specific engines like SPE (example: minSVElevation, minGPSWeek etc) or DRE, deletion of warm and cold aiding data, NMEA configuration and support for XTRA feature. *ILocationConfigurator* APIs strictly adheres to the principle of single client per process. [More...](#)

- class [ILocationInfoBase](#)

*ILocationInfoBase* provides interface to get basic position related information like latitude, longitude, altitude, timestamp. [More...](#)

- class [ILocationInfoEx](#)

*ILocationInfoEx* provides interface to get richer position related information like latitude, longitude, altitude and other information like time stamp, session status, dop, reliabilities, uncertainties etc. [More...](#)

- class [ILocationListener](#)

*Listener class for getting location updates and satellite vehicle information. [More...](#)*

- class [ILocationManager](#)

*[ILocationManager](#) provides interface to register and remove listeners. It also allows to set and get configuration/ criteria for position reports. The new APIs([registerListenerEx](#), [deRegisterListenerEx](#), [startDetailedReports](#), [startBasicReports](#)) and old/deprecated APIs([registerListener](#), [removeListener](#), [setPositionReportTimeout](#), [setHorizontalAccuracyLevel](#), [setMinIntervalForReports](#)) should not be used interchangeably, either the new APIs should be used or the old APIs should be used. [More...](#)*

- class [ILocationSystemInfoListener](#)

- class [ISVInfo](#)

*[ISVInfo](#) provides interface to retrieve information about Satellite Vehicles, their position and health status. [More...](#)*

- struct [LeapSecondChangeInfo](#)

- struct [LeapSecondInfo](#)

- struct [LeverArmParams](#)

- struct [LLAInfo](#)

- class [LocationFactory](#)

*[LocationFactory](#) allows creation of location manager. [More...](#)*

- struct [LocationSystemInfo](#)

- struct [NmeaConfig](#)

- struct [RobustLocationConfiguration](#)

- struct [RobustLocationVersion](#)

- struct [SvBlackListInfo](#)

- struct [SvUsedInPosition](#)

- struct [SystemTime](#)

- union [SystemTimeInfo](#)

- struct [TimeInfo](#)

- struct [XtraConfig](#)

- struct [XtraStatus](#)

## 5.10 telux::platform Namespace Reference

### Namespaces

- [diag](#)
- [hardware](#)



## Data Structures

- struct [EfsEventInfo](#)

- class [IDeviceInfoListener](#)

*Listener class for getting device info related notifications . The client needs to implement these methods as briefly as possible and avoid blocking calls in it. The methods in this class can be invoked from multiple different threads. Client needs to make sure that the implementation is thread-safe. [More...](#)*

- class [IDeviceInfoManager](#)

*IDeviceInfoManager provides interface to to retrieve IMEI and platform version operations. [More...](#)*

- class [IFsListener](#)

*Listener class for getting notifications related to EFS backup/restore operations. The client needs to implement these methods as briefly as possible and avoid blocking calls in it. The methods in this class can be invoked from multiple different threads. Client needs to make sure that the implementation is thread-safe. [More...](#)*

- class [IFsManager](#)

*IFsManager provides interface to to control and get notified about file system operations. This includes Embedded file system (EFS) operations. [More...](#)*

- class [ITimeListener](#)

*Listener class for getting time information. The client needs to implement these methods as briefly as possible and avoid blocking calls in it. The methods in this class can be invoked from multiple different threads. Client needs to make sure that the implementation is thread-safe. [More...](#)*

- class [ITimeManager](#)

*ITimeManager provides interface to retrieve time information. [More...](#)*

- class [PlatformFactory](#)

*PlatformFactory allows creation of Platform services related classes. [More...](#)*

- struct [PlatformVersion](#)

## 5.11 telux::platform::diag Namespace Reference

### Data Structures

- struct [DiagConfig](#)

- class [DiagnosticsFactory](#)

*DiagnosticsFactory is the central factory to create Diagnostics manager class. [More...](#)*

- struct [DiagStatus](#)

- struct [FileMethodConfig](#)

*Represents the config relevant to File method. Logs are saved to a file under the directory specified by platform.diag.diag\_output\_log\_path in tel.conf file. if Key does not exist, log will be stored in default location /tmp/diag. [More...](#)*

- class [IDiagListener](#)

- class [IDiagLogManager](#)

*IDiagLogManager* is a primary interface for Diagnostics. The interface offers APIs to configure log collection method (File or Callback) and configure log mode for selected method (streaming, threshold, or circular). The interface also provides APIs to start and stop diagnostics log collection in configured method and mode. [More...](#)

- union [SourceInfo](#)

## 5.12 telux::platform::hardware Namespace Reference

### Data Structures

- class [IAntennaListener](#)

*Listen class to get antenna configuration related notifications. The client needs to implement these methods as briefly as possible and avoid blocking calls. Class methods can be invoked from multiple threads, so the client needs to ensure that the implementation is thread-safe. [More...](#)*

- class [IAntennaManager](#)

*IAntennaManager* provides an interface to set and get the active antenna's configuration. [More...](#)

## 5.13 telux::power Namespace Reference

### Data Structures

- struct [ClientInstanceConfig](#)

- class [ITcuActivityListener](#)

*Listener class for getting notifications related to TCU-activity state and also the updates related to TCU-activity service status. The client needs to implement these methods as briefly as possible and avoid blocking calls in it. The methods in this class can be invoked from multiple different threads. Client needs to make sure that the implementation is thread-safe. [More...](#)*

- class [ITcuActivityManager](#)

*ITcuActivityManager* provides interface to register and de-register listeners to get TCU-activity state updates. And also API to initiate TCU-activity state transition. [More...](#)

- class [PowerFactory](#)

*PowerFactory* allows creation of TCU-activity manager instance. [More...](#)

## 5.14 telux::sec Namespace Reference

### Data Structures

- struct [ApInfo](#)
- struct [CACapacity](#)
- struct [CALoad](#)
- struct [CellularSecurityReport](#)

- class [ConnectionSecurityFactory](#)  
*ConnectionConnectionSecurityFactory allows creation of CellularSecurityManager and WiFiSecurityManager. [More...](#)*
- class [CryptoParamBuilder](#)
- struct [DataDigest](#)
- struct [DeauthenticationInfo](#)
- struct [ECCPoint](#)
- struct [EncryptedData](#)
- struct [EnvironmentInfo](#)
- class [ICAControlManager](#)
- class [ICAControlManagerListener](#)
- class [ICellularScanReportListener](#)
- class [ICellularSecurityManager](#)
- class [ICryptoAcceleratorListener](#)
- class [ICryptoAcceleratorManager](#)
- class [ICryptoManager](#)  
*ICryptoManager provides key management and crypto operation support. It uses trusted hardware bound cryptography. All keys generated are bound to the device cryptographically. [More...](#)*
- class [ICryptoParam](#)
- class [IWiFiReportListener](#)
- class [IWiFiSecurityManager](#)
- struct [LoadConfig](#)
- struct [MLAlgorithmAnalysis](#)
- struct [OperationResult](#)
- class [ResultParser](#)
- struct [Scalar](#)
- class [SecurityFactory](#)  
*SecurityFactory allows creation of ICryptoManager and ICryptoAcceleratorManager. [More...](#)*
- struct [SessionStats](#)
- struct [Signature](#)
- struct [SummoningAnalysis](#)
- struct [WiFiSecurityReport](#)

## 5.15 telux::sensor Namespace Reference

## Data Structures

- class [ISensorClient](#)

*ISensorClient* interface is used to access the different services provided by the sensor framework to configure, activate and acquire sensor data. [More...](#)
- class [ISensorEventListener](#)

*ISensorEventListener* interface is used to receive notifications related to sensor events and configuration updates. [More...](#)
- class [ISensorFeatureEventListener](#)

*ISensorFeatureEventListener* interface is used to receive notifications related to sensor feature events. [More...](#)
- class [ISensorFeatureManager](#)

*Sensor Feature Manager* class provides APIs to interact with the sensor framework to list the available features, enable them or disable them. The availability of sensor features depends on the capabilities of the underlying hardware. [More...](#)
- class [ISensorManager](#)

*Sensor Manager* class provides APIs to interact with the sensor sub-system and get access to other sensor objects which can be used to configure, activate or get data from the individual sensors available - Gyro, Accelerometer, etc. [More...](#)
- struct [MotionSensorData](#)

Structure of a single sample from a motion sensor. [More...](#)
- struct [SensorConfiguration](#)

Configurable parameters of a sensor. [More...](#)
- struct [SensorEvent](#)

Structure of a single sensor event. [More...](#)
- union [SensorEvent.\\_\\_unnamed\\_\\_](#)
- class [SensorFactory](#)

*SensorFactory* is the central factory to create instances of sensor objects. [More...](#)
- struct [SensorFeature](#)

Feature offered by sensor hardware and/or software framework. [More...](#)
- struct [SensorFeatureEvent](#)

Structure of an event that is generated from a sensor feature. [More...](#)
- struct [SensorInfo](#)

Information related to sensor. [More...](#)
- struct [UncalibratedMotionSensorData](#)

Structure of a single sample from uncalibrated motion sensor. [More...](#)

## 5.16 telux::tel Namespace Reference

### Data Structures

- struct [CardReaderStatus](#)
- class [CdmaCellIdentity](#)
- class [CdmaCellInfo](#)
- class [CdmaSignalStrengthInfo](#)
- struct [CellBroadcastFilter](#)
- class [CellBroadcastMessage](#)  
*Cell Broadcast message. [More...](#)*
- class [CellInfo](#)
- struct [CellularCapabilityInfo](#)
- class [Circle](#)
- class [CmasInfo](#)
- struct [CustomHeader](#)
- struct [CustomSipHeader](#)
- struct [DcStatus](#)
- struct [DeleteInfo](#)  
*Specify delete information used for deleting message on storage. [More...](#)*
- struct [EcallConfig](#)
- struct [ECallHlapTimerEvents](#)
- struct [ECallHlapTimerStatus](#)
- struct [ECallModeInfo](#)
- struct [ECallMsdControlBits](#)
- struct [ECallMsdData](#)
- struct [ECallMsdOptionals](#)
- struct [ECallOptionalPdu](#)
- struct [ECallVehicleIdentificationNumber](#)
- struct [ECallVehicleLocation](#)
- struct [ECallVehicleLocationDelta](#)
- struct [ECallVehiclePropulsionStorageType](#)
- class [EtwInfo](#)
- struct [FileAttributes](#)
- struct [ForwardInfo](#)

- struct [ForwardReq](#)
- class [Geometry](#)
- class [GsmCellIdentity](#)
- class [GsmCellInfo](#)
- class [GsmSignalStrengthInfo](#)
- class [IAtrResponseCallback](#)
- class [ICall](#)

*ICall* represents a call in progress. An *ICall* cannot be directly created by the client, rather it is returned as a result of instantiating a call or from the *PhoneListener* when receiving an incoming call. [More...](#)

- class [ICallListener](#)

A listener class for monitoring changes in call, including call state change and *ECall* state change. Override the methods for the state that you wish to receive updates for. [More...](#)

- class [ICallManager](#)

*Call Manager* is the primary interface for call related operations Allows to conference calls, swap calls, make normal voice call and emergency call, send and update *MSD pdu*. [More...](#)

- class [ICard](#)

*ICard* represents currently inserted *UICC* or *eUICC*. [More...](#)

- class [ICardApp](#)

Represents a single card application. [More...](#)

- class [ICardChannelCallback](#)
- class [ICardCommandCallback](#)
- class [ICardFileHandler](#)

*ICardFileHandler* provides APIs for reading from an elementary file(*EF*) on *SIM* and writing to *EF* on *SIM*. Provide API to get *EF* attributes like file size, record size, and the number of records in *EF*. [More...](#)

- class [ICardListener](#)
- class [ICardManager](#)

- class [ICardReaderCallback](#)

- struct [IccResult](#)

- class [ICellBroadcastListener](#)

A listener class which monitors cell broadcast messages. [More...](#)

- class [ICellBroadcastManager](#)

*CellBroadcastManager* class is primary interface to configure and activate emergency broadcast messages and receive broadcast messages. [More...](#)

- class [ICellularCapabilityCallback](#)
- class [IEcallListener](#)

Listener class to notify service status change notifications. The listener method can be invoked from

multiple different threads. Client needs to make sure that implementation is thread-safe. [More...](#)

- class [IEcallManager](#)

*IEcallManager* allows operations related to automotive emergency call management and its related configurations. [More...](#)

- class [IHttpTransactionListener](#)

The interface listens for indication to perform HTTP request and send back the response for HTTP request to modem. [More...](#)

- class [IHttpTransactionManager](#)

*IHttpTransactionManager* is the interface to service HTTP related requests from the modem for SIM profile update related operations. [More...](#)

- class [IImServingSystemListener](#)

A listener class for monitoring changes in IMS Serving System manager, including IMS registration status change. Override the methods for the state that you wish to receive updates for.

- class [IImServingSystemManager](#)

*IMS Serving System Manager* is the primary interface for IMS related operations Allows to query IMS registration status.

- class [IImSettingsListener](#)

Listener class for getting IMS service configuration change notifications. The listener method can be invoked from multiple different threads. Client needs to make sure that implementation is thread-safe. [More...](#)

- class [IImSettingsManager](#)

*ImSettingsManager* allows IMS settings. For example enabling or disabling IMS service, VOIMS service. [More...](#)

- class [IMakeCallCallback](#)

Interface for Make Call callback object. Client needs to implement this interface to get single shot responses for commands like make call. [More...](#)

- struct [ImRegistrationInfo](#)

- struct [ImServiceConfig](#)

- struct [ImServiceInfo](#)

- class [IMultiSimListener](#)

Listener class for getting high capability change notification. The listener method can be invoked from multiple different threads. Client needs to make sure that implementation is thread-safe. [More...](#)

- class [IMultiSimManager](#)

*MultiSimManager* allows to perform operation pertaining to devices which have more than one SIM/UICC card. Clients should check if the subsystem is ready before invoking any of the APIs as follows. [More...](#)

- class [INetworkSelectionListener](#)

Listener class for getting network selection mode change notification. [More...](#)

- class [INetworkSelectionManager](#)

*Network Selection Manager* class provides the interface to get and set network selection mode, preferred

network list and scan available networks. [More...](#)

- class [IOperatingModeCallback](#)

- class [IPhone](#)

*This class allows getting system information and registering for system events. Each Phone instance is associated with a single SIM. So on a dual SIM device you would have 2 Phone instances. [More...](#)*

- class [IPhoneListener](#)

*A listener class for monitoring changes in specific telephony states on the device, including service state and signal strength. Override the methods for the state that you wish to receive updates for. [More...](#)*

- class [IPhoneManager](#)

*Phone Manager creates one or more phones based on SIM slot count, it allows clients to register for notification of system events. Clients should check if the subsystem is ready before invoking any of the APIs. [More...](#)*

- class [IRemoteSimListener](#)

*A listener class for getting remote SIM notifications. [More...](#)*

- class [IRemoteSimManager](#)

*[IRemoteSimManager](#) provides APIs for remote SIM related operations. This allows a device to use a SIM card on another device for its WWAN modem functionality. The SIM provider service is the endpoint that interfaces with the SIM card (e.g. over bluetooth) and sends/receives data to the other endpoint, the modem. The modem sends requests to the SIM provider service to interact with the SIM card (e.g. power up, transmit APDU, etc.), and is notified of events (e.g. card errors, resets, etc.). This API is used by the SIM provider endpoint to provide a SIM card to the modem. [More...](#)*

- class [ISapCardCommandCallback](#)

- class [ISapCardListener](#)

- class [ISapCardManager](#)

*[ISapCardManager](#) provide APIs for SAP related operations. [More...](#)*

- class [IServingSystemListener](#)

*Listener class for getting notifications related to updates in radio access technology mode preference, service domain preference, serving system information, etc. Some notifications in this listener could be frequent in nature. When the system is in a suspended/low power state, those indications will wake the system up. This could result in increased power consumption by the system. If those notifications are not required in the suspended/low power state, it is recommended for the client to de-register specific notifications using the [deregisterListener](#) API. [More...](#)*

- class [IServingSystemManager](#)

- class [ISignalStrengthCallback](#)

*Interface for Signal strength callback object. Client needs to implement this interface to get single shot responses for commands like [get signal strength](#). [More...](#)*

- class [ISimProfileListener](#)

*The interface listens for profile download indication and keep track of download and install progress of profile. [More...](#)*

- class [ISimProfileManager](#)



*ISimProfileManager* is a primary interface for remote eUICCs (eSIMs or embedded SIMs) provisioning. This interface provides APIs to add, delete, set profile, update nickname, provide user consent, get Eid on the eUICC. [More...](#)

- class [ISmsAddressCallback](#)

- class [ISmsListener](#)

A listener class receives notification for the incoming message(s) and delivery report for sent message(s). [More...](#)

- class [ISmsManager](#)

*SmsManager* class is the primary interface to manage SMS operations such as send and receive an SMS text and raw encoded PDU(s). This class handles single part and multi-part messages. [More...](#)

- class [ISubscription](#)

Subscription returns information about network operator subscription details pertaining to a SIM card. [More...](#)

- class [ISubscriptionListener](#)

A listener class for receiving device subscription information. The methods in listener can be invoked from multiple different threads. The implementation should be thread safe. [More...](#)

- class [ISubscriptionManager](#)

- class [ISuppServicesListener](#)

A listener class for receiving supplementary services notifications. The methods in listener can be invoked from multiple different threads. The implementation should be thread safe. [More...](#)

- class [ISuppServicesManager](#)

*ISuppServicesManager* is the interface to provide supplementary services like call forwarding and call waiting. [More...](#)

- class [IVoiceServiceStateCallback](#)

Interface for voice service state callback object. Client needs to implement this interface to get single shot responses for commands like request voice radio technology. [More...](#)

- class [LteCellIdentity](#)

- class [LteCellInfo](#)

- class [LteSignalStrengthInfo](#)

- struct [MessageAttributes](#)

Contains structure of message attributes like encoding type, number of segments, characters left in last segment. [More...](#)

- struct [MessagePartInfo](#)

Structure containing information about the part of multi-part SMS such as concatenated message reference number, number of segments and segment number. During concatenation this information along with originating address helps in associating each part of the multi-part message to the corresponding multi-part message. [More...](#)

- struct [NetworkScanInfo](#)

- struct [NetworkTimeInfo](#)

- class [Nr5gCellIdentity](#)
- class [Nr5gCellInfo](#)
- class [Nr5gSignalStrengthInfo](#)
- class [OperatorInfo](#)
- struct [OperatorStatus](#)
- class [PhoneFactory](#)

*PhoneFactory* is the central factory to create all Telephony SDK Classes and services. [More...](#)

- struct [Point](#)
- class [Polygon](#)
- struct [PreferredNetworkInfo](#)
- struct [RFBandInfo](#)
- struct [ServingSystemInfo](#)
- class [SignalStrength](#)
- struct [SignalStrengthConfig](#)
- union [SignalStrengthConfig.\\_\\_unnamed\\_\\_](#)
- struct [SignalStrengthThreshold](#)
- class [SimProfile](#)

*SimProfile* class represents single eUICC profile on the card. [More...](#)

- struct [SimRatCapability](#)
- struct [SlotStatus](#)
- class [SmsMessage](#)

*Data structure represents an incoming SMS. This is applicable for single part message or part of the multipart message. [More...](#)*

- struct [SmsMetaInfo](#)

*Provides certain attributes of an SMS message. [More...](#)*

- class [TdscdmaCellIdentity](#)
- class [TdscdmaCellInfo](#)
- class [TdscdmaSignalStrengthInfo](#)
- class [VoiceServiceInfo](#)
- class [WarningAreaInfo](#)
- class [WcdmaCellIdentity](#)
- class [WcdmaCellInfo](#)
- class [WcdmaSignalStrengthInfo](#)

## 5.16.1 Data Structure Documentation

### 5.16.1.1 struct telux::tel::ImsRegistrationInfo

Defines the IMS registration status parameters and the error code value

#### Data fields

Type	Field	Description
<a href="#">Registration↔ Status</a>	imsRegStatus	The status of the IMS registration with the network
<a href="#">Radio↔ Technology</a>	rat	The RAT is returned when IMS registration is being attempted or is successful
int	errorCode	An error code is returned when the IMS registration status is <a href="#">RegistrationStatus::NOT_REGISTERED</a> . Values(Defined in SIP-RFC3261 section 13.2.2.2 and section 13.2.2.3): <ul style="list-style-type: none"> <li>• 3xx – Redirection responses</li> <li>• 4xx – Client failure responses</li> <li>• 5xx – Server failure responses</li> <li>• 6xx – Global failure responses</li> </ul>
string	errorString	Registration failure error string when the IMS is not registered.

### 5.16.1.2 struct telux::tel::ImsServiceInfo

Represents the status for supporting various services over IMS.

#### Data fields

Type	Field	Description
<a href="#">Cellular↔ ServiceStatus</a>	sms	SMS service status over IMS
<a href="#">Cellular↔ ServiceStatus</a>	voice	Voice service status over IMS

## 5.16.2 Typedef Documentation

### 5.16.2.1 using telux::tel::ImsRegistrationInfoCb = typedef std::function<void(Ims↔ RegistrationInfo status, telux::common::ErrorCode error)>

This function is called in the response to requestRegistrationInfo API.

The callback can be invoked from multiple different threads. The implementation should be thread safe.

#### Parameters

in	<i>status</i>	Indicates the IMS registration status and the error code <a href="#">telux::tel::ImsRegistrationInfo</a> .
----	---------------	--

<i>in</i>	<i>error</i>	Return code which indicates whether the operation succeeded or not <a href="#">telux::common::ErrorCode</a> .
-----------	--------------	---

### 5.16.2.2 using telux::tel::ImsServiceInfoCb = typedef std::function<void(ImsServiceInfo service, telux::common::ErrorCode error)>

This function is called in response to the requestServiceInfo API.

The callback can be invoked from multiple different threads. The implementation should be thread safe.

#### Parameters

<i>in</i>	<i>service</i>	Indicates the IMS service information <a href="#">telux::tel::ImsServiceInfo</a> .
<i>in</i>	<i>error</i>	Return code which indicates whether the operation succeeded or not <a href="#">telux::common::ErrorCode</a> .

### 5.16.2.3 using telux::tel::RatMask = typedef std::bitset<16>

16 bit mask that denotes which of the radio access technologies defined in RatType enum are used for preferred networks.

### 5.16.2.4 using telux::tel::SelectionModeResponseCallback = typedef std::function<void(NetworkSelectionMode mode, telux::common::ErrorCode error)>

This function is called with the response to requestNetworkSelectionMode API.

The callback can be invoked from multiple different threads. The implementation should be thread safe.

#### Parameters

<i>in</i>	<i>mode</i>	<a href="#">NetworkSelectionMode</a>
<i>in</i>	<i>error</i>	Return code which indicates whether the operation succeeded or not <a href="#">telux::common::ErrorCode</a>

### 5.16.2.5 using telux::tel::PreferredNetworksCallback = typedef std::function<void(std::vector<PreferredNetworkInfo> info, std::vector<PreferredNetworkInfo> staticInfo, telux::common::ErrorCode error)>

This function is called with the response to requestPreferredNetworks API.

The callback can be invoked from multiple different threads. The implementation should be thread safe.

#### Parameters

<i>in</i>	<i>info</i>	3GPP preferred networks list i.e PLMN list.
<i>in</i>	<i>staticInfo</i>	Static 3GPP preferred networks list i.e OPLMN list.

in	<i>error</i>	Return code which indicates whether the operation succeeded or not. <a href="#">telux::common::ErrorCode</a>
----	--------------	--

### 5.16.2.6 using telux::tel::NetworkScanCallback = typedef std::function<void(std::vector<OperatorInfo> operatorInfos, telux::common::ErrorCode error)>

This function is called with the response to performNetworkScan API.

The callback can be invoked from multiple different threads. The implementation should be thread safe.

#### Parameters

in	<i>operatorInfos</i>	Operators info with details of network operator name, MCC, MNC and status.
in	<i>error</i>	Return code which indicates whether the operation succeeded or not. <a href="#">telux::common::ErrorCode</a>

## 5.16.3 Enumeration Type Documentation

### 5.16.3.1 enum telux::tel::RegistrationStatus [strong]

Defines the IMS registration status parameters

#### Enumerator

**UNKOWN\_STATE** Unknown status for IMS  
**NOT\_REGISTERED** Not registered status for IMS  
**REGISTERING** Registering status for IMS  
**REGISTERED** Registered status for IMS  
**LIMITED\_REGISTERED** Limited registration status for IMS

### 5.16.3.2 enum telux::tel::CellularServiceStatus [strong]

Defines the cellular service status parameters.

#### Enumerator

**UNKNOWN** Unknown service status  
**NO\_SERVICE** Unavailable service status  
**LIMITED\_SERVICE** Emergency service status  
**FULL\_SERVICE** Available service status

## 5.17 telux::therm Namespace Reference

## Data Structures

- struct [BoundCoolingDevice](#)

- class [ICoolingDevice](#)

*ICoolingDevice* provides interface to get type of the cooling device, the maximum throttle state and the currently requested throttle state of the cooling device. [More...](#)

- class [IThermalListener](#)

*Listener* class for getting notifications when thermal service status changes. The client needs to implement these methods as briefly as possible and avoid blocking calls in it. The methods in this class can be invoked from multiple different threads. Client needs to make sure that the implementation is thread-safe. [More...](#)

- class [IThermalManager](#)

*IThermalManager* provides interface to get thermal zone and cooling device information. [More...](#)

- class [IThermalShutdownListener](#)

*Listener* class for getting notifications when automatic thermal shutdown mode is enabled/ disabled or will be enabled imminently. The client needs to implement these methods as briefly as possible and avoid blocking calls in it. The methods in this class can be invoked from multiple different threads. Client needs to make sure that the implementation is thread-safe. [More...](#)

- class [IThermalShutdownManager](#)

*IThermalShutdownManager* class provides interface to enable/disable automatic thermal shutdown. Additionally it facilitates to register for notifications when the automatic shutdown mode changes. [More...](#)

- class [IThermalZone](#)

*IThermalZone* provides interface to get type of the sensor, the current temperature reading, trip points and the cooling devices binded etc. [More...](#)

- class [ITripPoint](#)

*ITripPoint* provides interface to get trip point type, trip point temperature and hysteresis value for that trip point. [More...](#)

- class [ThermalFactory](#)

*ThermalFactory* allows creation of thermal manager. [More...](#)

## 5.18 telux::wlan Namespace Reference

### Data Structures

- struct [ApConfig](#)
- struct [ApElementInfoConfig](#)
- struct [ApInfo](#)
- struct [ApNetConfig](#)
- struct [ApNetInfo](#)
- struct [ApSecurity](#)
- struct [ApStatus](#)

- struct [ApVenueInfo](#)
- struct [DeviceIndInfo](#)
- struct [DeviceInfo](#)
- class [IApInterfaceManager](#)  
*Manager class for configuring Wlan Access Points. [More...](#)*
- class [IApListener](#)
- struct [InterfaceStatus](#)
- class [IStaInterfaceManager](#)  
*Manager class for configuring Wlan Station Mode. [More...](#)*
- class [IStaListener](#)
- class [IWlanDeviceManager](#)  
*WlanDeviceManager is a primary interface for configuring Wireless LAN. it provide APIs to enable, configure, activate, and modify modes. [More...](#)*
- class [IWlanListener](#)
- struct [RegulatoryParams](#)
- struct [StaConfig](#)
- struct [StaStaticIpConfig](#)
- struct [StaStatus](#)
- class [WlanFactory](#)  
*WlanFactory is the central factory to create all wlan classes. [More...](#)*

# 6 Data Structure Documentation

---

## 6.1 telux::cv2x::ICv2xListener Class Reference

Cv2x Radio Manager listeners implement this interface.

### Public member functions

- virtual void [onStatusChanged](#) (Cv2xStatus status)
- virtual void [onStatusChanged](#) (Cv2xStatusEx status)
- virtual void [onSlssRxInfoChanged](#) (const SlssRxInfo &slssInfo)
- virtual [~ICv2xListener](#) ()

Cv2x Radio Manager listeners implement this interface.

### 6.1.1 Constructors and Destructors

#### 6.1.1.1 virtual telux::cv2x::ICv2xListener::~~ICv2xListener ( ) [virtual]

Destructor for [ICv2xListener](#)

### 6.1.2 Member Function Documentation

#### 6.1.2.1 virtual void telux::cv2x::ICv2xListener::onStatusChanged ( Cv2xStatus *status* ) [virtual]

Called when the status of the CV2X radio has changed.

#### Parameters

in	<i>status</i>	- CV2X radio status.
----	---------------	----------------------

#### Deprecated

use [onStatusChanged\(Cv2xStatusEx status\)](#)



### 6.1.2.2 virtual void telux::cv2x::ICv2xListener::onStatusChanged ( Cv2xStatusEx *status* ) [virtual]

Called when the status of the CV2X radio has changed.

#### Parameters

in	<i>status</i>	- CV2X radio status.
----	---------------	----------------------

### 6.1.2.3 virtual void telux::cv2x::ICv2xListener::onSlssRxInfoChanged ( const SlssRxInfo & *slssInfo* ) [virtual]

Called when CV2X SLSS Rx is enabled and any of below events has occurred:

- A new SLSS sync reference UE is detected, lost, or selected as the timing source, report the present sync reference UEs.
- UE timing source switches from SLSS to GNSS, report 0 sync reference UE.
- SLSS Rx is disabled, report 0 sync reference UE.
- Cv2x is stopped, report 0 sync reference UE.

#### Parameters

in	<i>slssInfo</i>	- CV2X SLSS Rx information.
----	-----------------	-----------------------------

## 6.2 telux::tel::IImServingSystemListener Class Reference

A listener class for monitoring changes in IMS Serving System manager, including IMS registration status change. Override the methods for the state that you wish to receive updates for.

#### Public member functions

- virtual void [onServiceStatusChange](#) (telux::common::ServiceStatus status)
- virtual void [onImsRegStatusChange](#) (ImsRegistrationInfo status)
- virtual void [onImsServiceInfoChange](#) (ImsServiceInfo service)
- virtual [~IImServingSystemListener](#) ()

A listener class for monitoring changes in IMS Serving System manager, including IMS registration status change. Override the methods for the state that you wish to receive updates for.

The methods in listener can be invoked from multiple different threads. The implementation should be thread safe.

### 6.2.1 Constructors and Destructors

**6.2.1.1** virtual `telux::tel::IImsservingSystemListener::~~IImsservingSystemListener ( )` [virtual]

## 6.2.2 Member Function Documentation

**6.2.2.1** virtual void `telux::tel::IImsservingSystemListener::onServiceStatusChange ( telux::common::ServiceStatus status )` [virtual]

This function is called when service status changes.

### Parameters

<code>in</code>	<code>status</code>	- <a href="#">telux::common::ServiceStatus</a>
-----------------	---------------------	--

Reimplemented from [telux::common::IServiceStatusListener](#).

**6.2.2.2** virtual void `telux::tel::IImsservingSystemListener::onImsserviceInfoChange ( ImsRegistrationInfo status )` [virtual]

This function is called whenever any IMS service configuration is changed.

### Parameters

<code>in</code>	<code>status</code>	Indicates which registration status is the IMS service changed to. <a href="#">telux::tel::ImsRegistrationInfo</a> .
-----------------	---------------------	--

**6.2.2.3** virtual void `telux::tel::IImsservingSystemListener::onImsserviceInfoChange ( ImsServiceInfo service )` [virtual]

This function is called whenever any IMS service information is changed.

### Parameters

<code>in</code>	<code>service</code>	Indicates which IMS service information has changed. <a href="#">telux::tel::ImsServiceInfo</a> .
-----------------	----------------------	---

## 6.3 telux::tel::IImsservingSystemManager Class Reference

IMS Serving System Manager is the primary interface for IMS related operations Allows to query IMS registration status.

### Public member functions

- virtual [telux::common::ServiceStatus](#) `getServiceStatus ()=0`
- virtual [telux::common::Status](#) `requestRegistrationInfo (ImsRegistrationInfoCb callback)=0`
- virtual [telux::common::Status](#) `requestServiceInfo (ImsServiceInfoCb callback)=0`

- virtual `telux::common::Status registerListener (std::weak_ptr<telux::tel::ImsServingSystemListener > listener)=0`
- virtual `telux::common::Status deregisterListener (std::weak_ptr<telux::tel::ImsServingSystemListener > listener)=0`
- virtual `~ImsServingSystemManager ()`

IMS Serving System Manager is the primary interface for IMS related operations Allows to query IMS registration status.

## 6.3.1 Constructors and Destructors

**6.3.1.1** virtual `telux::tel::ImsServingSystemManager::~~ImsServingSystemManager ( ) [virtual]`

## 6.3.2 Member Function Documentation

**6.3.2.1** virtual `telux::common::ServiceStatus telux::tel::ImsServingSystemManager↔::getServiceStatus ( ) [pure virtual]`

This status indicates whether the `ImsServingSystemManager` object is in a usable state.

### Returns

SERVICE\_AVAILABLE - If IMS Serving System manager is ready for service.  
 SERVICE\_UNAVAILABLE - If IMS Serving System manager is temporarily unavailable.  
 SERVICE\_FAILED - If IMS Serving System manager encountered an irrecoverable failure.

**6.3.2.2** virtual `telux::common::Status telux::tel::ImsServingSystemManager↔::requestRegistrationInfo ( ImsRegistrationInfoCb callback ) [pure virtual]`

Request IMS registration information.

### Parameters

in	<i>callback</i>	Callback pointer to get the response of requestRegistrationInfo.
----	-----------------	--

### Returns

Status of requestRegistrationInfo i.e. success or suitable status code.

**6.3.2.3** virtual `telux::common::Status telux::tel::ImsServingSystemManager↔::requestServiceInfo ( ImsServiceInfoCb callback ) [pure virtual]`

Request IMS service information, such as SMS and voice service status over IMS.

**Parameters**

in	<i>callback</i>	Callback pointer to get the response of requestServiceInfo.
----	-----------------	---

**Returns**

Status of requestServiceInfo i.e., success or suitable status code.

### 6.3.2.4 virtual telux::common::Status telux::tel::IImServiceSystemManager↔ ::registerListener ( std::weak\_ptr< telux::tel::IImServiceSystemListener > *listener* ) [pure virtual]

Add a listener to listen for specific events in the IMS Serving System subsystem.

**Parameters**

in	<i>listener</i>	Pointer to <a href="#">IImServiceSystemListener</a> object that processes the notification
----	-----------------	--

**Returns**

Status of registerListener i.e. success or suitable error code.

### 6.3.2.5 virtual telux::common::Status telux::tel::IImServiceSystemManager↔ ::deregisterListener ( std::weak\_ptr< telux::tel::IImServiceSystemListener > *listener* ) [pure virtual]

Remove a previously added listener.

**Parameters**

in	<i>listener</i>	Listener to be removed.
----	-----------------	-------------------------

**Returns**

Status of deregisterListener i.e. success or suitable error code.

## 6.4 telux::common::IServiceStatusListener Class Reference

**Public member functions**

- virtual void [onServiceStatusChange](#) ([ServiceStatus](#) status)
- virtual [~IServiceStatusListener](#) ()

## 6.4.1 Constructors and Destructors

6.4.1.1 virtual telux::common::IServiceStatusListener::~~IServiceStatusListener ( )  
[virtual]

## 6.4.2 Member Function Documentation

6.4.2.1 virtual void telux::common::IServiceStatusListener::onServiceStatusChange (   
ServiceStatus *status* ) [virtual]

This function is called when service status changes.

### Parameters

in	<i>status</i>	- <a href="#">ServiceStatus</a>
----	---------------	---------------------------------

Reimplemented in [telux::tel::IImServiceSystemListener](#).